

DORMER  **PRAMET**

TALADRADO

2024



 **DORMER**

 **PRAMET**























MECANIZADO DE AGUJEROS – CONTENIDO GENERAL

MECANIZADO DE AGUJEROS

Herramientas para fabricación básica, construcción, mantenimiento, reparación, revisión. Utilizadas normalmente con herramientas eléctricas y máquinas convencionales. Adecuadas para parámetros de corte bajos.

Herramientas para fabricación mixta. Utilizadas normalmente con máquinas convencionales con avances de máquina y CNC. Adecuadas para parámetros de corte moderados.

Herramientas para procesos seguros y productividad. Utilizadas normalmente con CNC y fabricación automatizada. Adecuadas para parámetros de corte elevados.

	Bocas de puntear y de serie extra corta	< 2.5 x D	 7
	Brocas de serie corta	< 4 x D	17
	Bocas de serie larga y extra larga	< 10 x D	35
	Brocas aeroespaciales	NAS 907	41
	Avellanadores		59
	Escariadores		73
	Juegos de brocas y accesorios		90
	Brocas de serie extra corta	< 3 x D	103
	Brocas de serie corta	< 5 x D	115
	Bocas de serie larga y extra larga	< 25 x D	125
	Brocas escalonadas y avellanadores		135
	Brocas de centrar		147
	Avellanadores		157
	Escariadores		167
	Brocas de puntear de metal duro		181
	Brocas de metal duro	< 8 x D	187
	Brocas Hydra (cabeza intercambiable)	1.5 – 12 x D	217
	Brocas de plaquita intercambiable (brocas U)	2 – 5 x D	235
	Escariadores de metal duro		249

INSTRUCCIONES

¿Cómo leer los datos del catálogo? (ISO 13399, iconos, navegación...)		258
Materials, recubrimientos y calidades		270
Brocas – información técnica	274	Tablas de avance 272
Escariadores – información técnica	279	Tablas de avance 276
Brocas de plaquita intercambiable – información técnica	288	Tablas de avance 281
Grupos de materiales de pieza (WMG)		291



HERRAMIENTAS ROTATIVAS DE METAL DURO: ÍNDICE (ALFABÉTICO)

FAMILIA DE PRODUCTOS		FAMILIA DE PRODUCTOS		FAMILIA DE PRODUCTOS		FAMILIA DE PRODUCTOS	
0		A295	95	B660	85	G705	141
2ACO	57	A296	156	B670	86	G706	142
500-6/501-6/502-6	48	A321	18	B680	87	H	
500-12/501-12/502-12	50	A400	143	B690	64	H851	218
A		A402	144	B901	168	H853	219
A002	30	A412	146	B903	82	H855	221
A002S	32	A413	145	B952	83	H858	223
A022	14	A510	120	B953	81	H860	229
A080	99	A520	105	B954	175	H861	229
A087	93	A553	122	C		H8512	224
A088	92	A620	107	CO500-6/CO501-6	55	M	
A089	92	A720	104	CO500-12/CO501-12	56	M900	98
A094	93	A723	8	E		M901	99
A095	94	A777	116	EP	247	M902	99
A099 Drillboy	94	A900	126	E		R	
A100	19	A920	110	G106	67	R003	123
A101	23	A940	128	G107	69	R10A/R15A/R18A	44
A108	33	A952	133	G125	137	R10B/R15B/R18B	46
A110	36	A976	130	G129	62	R10CO/R15CO/R18CO	53
A117	108	A977	131	G132	63	R023	112
A119	10	A978	132	G135	60	R40C/R41C/R42C	42
A120	12	B		G136	66	R88CO/R89CO	52
A122	9	B100	74	G137	164	R122	184
A123	11	B101	174	G138	165	R123	182
A125	38	B121	176	G142	65	R125	185
A130	26	B122	88	G149	159	R200	156
A147	118	B161	173	G154	61	R453	203
A170	24	B170	171	G171	163	R454	199
A188	95	B180	169	G236	71	R457	195
A190	96	B301	80	G314	136	R458	191
A191	97	B400	250	G335	158	R459	207
A191_2	97	B411	254	G338	166	R463	213
A200	148	B441	253	G400	162	R467	210
A201	153	B442	255	G506	68	R510	190
A205	149	B481	251	G560	160	R520	188
A206	150	B610	76	G570	161	R950	225
A210	152	B620	78	G600	70	R960	227
A225	154	B630	84	G702	138	R6011	183
A242	155	B640	177	G703	139	R7131	216
A266	151	B650	79	G704	140		



HERRAMIENTAS INTERCAMBIABLES: ÍNDICE (ALFABÉTICO)

FAMILIA DE PRODUCTOS	
0	
802D	236
803D	238
804D	241
805D	243

PLAQUITAS INTERCAMBIABLES: ÍNDICE (ALFABÉTICO)

FAMILIA DE PRODUCTOS	
S	
SCET	245
XPET	246



**HERRAMIENTAS PARA FABRICACIÓN BÁSICA, CONSTRUCCIÓN,
MANTENIMIENTO, REPARACIÓN, REVISIÓN. UTILIZADAS NORMALMENTE
CON HERRAMIENTAS ELÉCTRICAS Y MÁQUINAS CONVENCIONALES.**

Código de Material (BMC)	HSS-E	HSS	HSS	HSS	HSS	HSS							
Grupo básico estándar (BSG)		DIN 1897	DIN 1897	DIN 1897	DIN 1897	DIN ANSI							
Longitud Útil (ULDR)	1×D	1×D	1.25×D	1.5×D	2.5×D	2.5×D							
Ángulo de aplicación	180°	90°/120°	120°	120°	135°	135°							
Recubrimiento	Bronze	Bright	ST	ST	ST	TiN-Tip							
Mango													
Forma de la Hélice	λ 20-35°	λ 20-35°	λ 20-35°	λ 20-35°	λ 20-35°	λ 20-35°							
Mano (dirección de corte)													

Código de Familia de Producto		A723	A122	A119	A123	A120	A022						
Gama de diámetros de corte PSF		6.00 - 8.00	6.00 - 20.00	3.30 - 5.10	3/32 - 1/4	0.50 - 25.00	0.50 - 16.00						
P	P1	■	■	■	■	■	■						
	P2	▣	■	▣	▣	■	■						
	P3	▣	▣	▣	▣	■	■						
	P4	▣	▣	▣	▣	▣	■						
M	M1		▣	▣	▣	■	■						
	M2		▣	▣	▣	■	■						
	M3		▣	▣	▣	▣	▣						
	M4		▣	▣	▣	▣	▣						
K	K1		▣			■	■						
	K2		▣			■	■						
	K3		▣			■	■						
	K4		▣			▣	▣						
	K5		▣			■	■						
N	N1		■	▣	■	▣	■						
	N2		▣	▣	▣	▣	■						
	N3		■	▣	■	▣	▣						
	N4		▣	▣	▣	▣	▣						
	N5												
S	S1		▣	▣	▣	▣	▣						
	S2		▣	▣	▣	▣	▣						
	S3		▣	▣	▣	▣	▣						
	S4		▣	▣	▣	▣	▣						
H	H1												
	H2												
	H3												
	H4												

A723



Broca HSS-E (5% Cobalto), para Puntos de Soldadura, Acabado Bronce Templado

Broca con punto central y filos especialmente diseñados para eliminar o "soltar" áreas soldadas por puntos, normalmente para quitar soldaduras en un taller de reparación de vehículos. La corta longitud de los canales la hace más resistente y menos propensa a romperse cuando se usa en un dispositivo manual. El acabado bronce consiste en una fina capa de óxido y es un indicativo de cobalto.

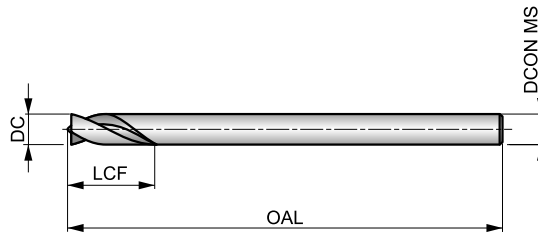

HSS-E	DORMER	1xD
Bronze		λ 20-35°
R	DC h8	

Grupo de Material de la pieza adecuado y condiciones de velocidad de corte iniciales (m/min) y código de avance alfabético. Tablas con avance por revolución a partir de la pag.274.

- P1.1**
■ 33 D
- P1.2**
■ 37 D
- P1.3**
■ 38 D
- P2.1**
■ 28 D
- P2.2**
■ 25 C
- P3.1**
■ 20 C
- P3.2**
■ 20 C
- P4.1**
■ 20 C

Product	DC	DC	LCF	OAL	DCON MS
	(mm)	(inch)			
A7236.0X66	6.00	0.2362	18.0	66.0	6.00
A7236.0X93	6.00	0.2362	18.0	93.0	6.00
A7238.0X79	8.00	0.3150	24.0	79.0	8.00
A7238.0X117	8.00	0.3150	24.0	117.0	8.00

A122



Broca de Centrar HSS, Acabado Brillante

Esta broca se utiliza para crear un agujero en el material que se va a taladrar para garantizar que el punto de inicio sea preciso. Esta disponible con un ángulo de punta de 90° o 120°, lo que le ofrece dos opciones de punteado. Acabado brillante. Adecuada para taladrar en la mayoría de materiales.

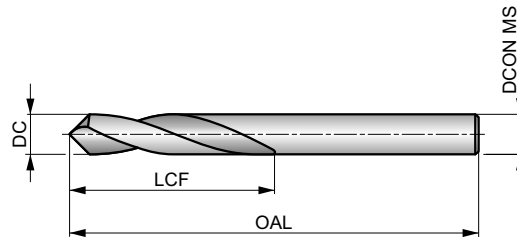

HSS	DIN 1897	1xD
90°/120°	Bright	
λ 20-35°	R	DC h8

Grupo de Material de la pieza adecuado y condiciones de velocidad de corte iniciales (m/min) y código de avance alfabético. Tablas con avance por revolución a partir de la pag.274.

P1.1 ■ 36 E	P1.2 ■ 40 E	P1.3 ■ 41 E	P2.1 ■ 31 E	P2.2 ■ 27 C	P2.3 ■ 24 C	P3.1 ■ 21 C	P3.2 ■ 17 C	P3.3 ■ 14 C	P4.1 ■ 12 C	P4.2 ■ 10 C	P4.3 ■ 9 B	M1.1 ■ 22 C	M1.2 ■ 19 C
M2.1 ■ 20 C	M2.2 ■ 16 C	M3.1 ■ 10 D	M3.2 ■ 9 D	M3.3 ■ 8 D	M4.1 ■ 10 B	K1.1 ■ 32 E	K1.2 ■ 24 C	K1.3 ■ 18 C	K2.1 ■ 25 C	K2.2 ■ 20 C	K2.3 ■ 16 B	K3.1 ■ 22 C	K3.2 ■ 17 C
K3.3 ■ 13 B	K4.1 ■ 20 C	K4.2 ■ 15 C	K4.3 ■ 11 B	K4.4 ■ 10 B	K4.5 ■ 8 B	K5.1 ■ 23 C	K5.2 ■ 17 C	K5.3 ■ 13 B	N1.1 ■ 33 E	N1.2 ■ 25 E	N1.3 ■ 17 E	N2.1 ■ 46 D	N2.2 ■ 42 D
N2.3 ■ 30 D	N3.1 ■ 56 D	N3.2 ■ 33 E	N3.3 ■ 17 D	N4.1 ■ 30 F	N4.2 ■ 35 E	N4.3 ■ 17 D	S1.1 ■ 27 C	S1.2 ■ 12 B	S1.3 ■ 7 A	S2.1 ■ 11 C	S2.2 ■ 6 A	S3.1 ■ 8 C	S3.2 ■ 4 A
S4.1 ■ 6 C	S4.2 ■ 3 A												

Product	DC	DC	LCF	OAL	DCON MS
	(mm)	(inch)			
A1226.0X90	6.00	0.2362	30.0	66.0	6.00
A1226.0X120	6.00	0.2362	30.0	66.0	6.00
A1228.0X90	8.00	0.3150	33.0	79.0	8.00
A1228.0X120	8.00	0.3150	33.0	79.0	8.00
A12210.0X90	10.00	0.3937	35.0	89.0	10.00
A12210.0X120	10.00	0.3937	35.0	89.0	10.00
A12212.0X90	12.00	0.4724	40.0	102.0	12.00
A12212.0X120	12.00	0.4724	40.0	102.0	12.00
A12216.0X90	16.00	0.6299	40.0	115.0	16.00
A12216.0X120	16.00	0.6299	40.0	115.0	16.00
A12220.0X90	20.00	0.7874	55.0	131.0	20.00

A119



Broca HSS Extra Corta, Doble Punta, Acabado Templado al Vapor. Broca para Chapas.

Una broca corta de doble punta diseñada para taladrar agujeros en chapa. Posibilidad de utilizar ambos extremos, ofreciendo el doble de vida útil. Punta convencional a 120° para mejorar al autocentrado. Adecuadas para taladrar en la mayoría de materiales. El acabado templado al vapor retiene el fluido de corte y evita que la viruta se suelde a la herramienta.

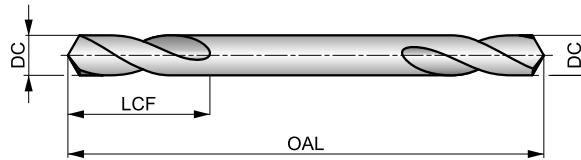

HSS	DIN 1897	1.25xD
120°		
λ 20-35°		DC h8

Grupo de Material de la pieza adecuado y condiciones de velocidad de corte iniciales (m/min) y código de avance alfabético. Tablas con avance por revolución a partir de la pag.274.

P1.1 ■ 31 C	P1.2 ■ 34 C	P1.3 ■ 35 C	P2.1 ■ 26 C	P2.2 ■ 23 C	P2.3 ■ 20 C	P3.1 ■ 12 C	P3.2 ■ 9 C	P3.3 ■ 8 C	P4.1 ■ 7 C	P4.2 ■ 6 C	P4.3 ■ 5 A	M1.1 ■ 21 A	M1.2 ■ 17 A
M2.1 ■ 18 A	M2.2 ■ 15 A	M3.1 ■ 8 C	M3.2 ■ 7 C	M3.3 ■ 6 C	M4.1 ■ 10 A	N1.1 ■ 33 C	N1.2 ■ 25 C	N1.3 ■ 17 C	N2.1 ■ 46 C	N2.2 ■ 42 C	N2.3 ■ 30 C	N3.1 ■ 56 C	N3.2 ■ 33 C
N3.3 ■ 17 A	N4.1 ■ 30 I	N4.2 ■ 35 C	S1.1 ■ 27 A	S1.2 ■ 12 A	S1.3 ■ 17 A	S2.1 ■ 5 C	S2.2 ■ 4 C	S3.1 ■ 4 C	S3.2 ■ 3 C	S4.1 ■ 3 C	S4.2 ■ 2 C		

Broca para chapas

Product	DC	DC	LCF	OAL	DCON MS
	(mm)	(inch)			
A1193.3	3.30	0.1299	11.0	49.0	3.30
A1193.6	3.60	0.1417	12.0	52.0	3.60
A1194.1	4.10	0.1614	14.0	55.0	4.10
A1194.2	4.20	0.1654	14.0	55.0	4.20
A1194.9	4.90	0.1929	17.0	62.0	4.90
A1195.1	5.10	0.2008	17.0	62.0	5.10

A123



Broca HSS Serie Extra Corta para Chapas Metálicas, Acabado Templado al Vapor

Especialmente diseñada para taladrar piezas delgadas y chapas. Punta de 120° y acabado templado al vapor que evita que el material de la pieza se adhiera al filo, lo que proporciona un mejor acabado del agujero y un diámetro más preciso. Adecuada para taladrar en muchos materiales.

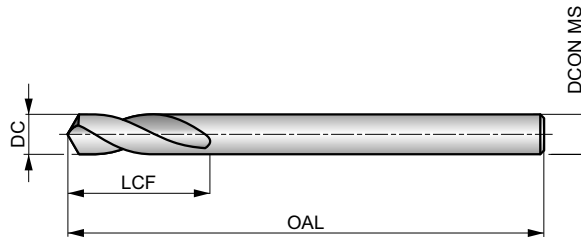

HSS	DIN 1897	1.5×D
120°	ST	
λ 20-35°	R	DC h8

Grupo de Material de la pieza adecuado y condiciones de velocidad de corte iniciales (m/min) y código de avance alfabético. Tablas con avance por revolución a partir de la pag.274.

P1.1 ■ 36 E	P1.2 ■ 40 E	P1.3 ■ 41 E	P2.1 ■ 31 E	P2.2 ■ 27 C	P2.3 ■ 24 C	P3.1 ■ 21 C	P3.2 ■ 17 C	P3.3 ■ 14 C	P4.1 ■ 12 C	P4.2 ■ 10 C	P4.3 ■ 9 B	M1.1 ■ 22 C	M1.2 ■ 19 C
M2.1 ■ 20 C	M2.2 ■ 16 C	M3.1 ■ 10 D	M3.2 ■ 9 D	M3.3 ■ 8 D	M4.1 ■ 10 B	N1.1 ■ 33 E	N1.2 ■ 25 E	N1.3 ■ 17 E	N2.1 ■ 46 D	N2.2 ■ 42 D	N2.3 ■ 30 D	N3.1 ■ 56 D	N3.2 ■ 33 E
N3.3 ■ 17 D	N4.1 ■ 30 F	N4.2 ■ 35 E	N4.3 ■ 17 D	S1.1 ■ 27 C	S1.2 ■ 12 B	S1.3 ■ 7 A	S2.1 ■ 11 C	S2.2 ■ 6 A	S3.1 ■ 8 C	S3.2 ■ 4 A	S4.1 ■ 6 C	S4.2 ■ 3 A	

Broca para chapas

Product	DC	DC	DC	LCF	OAL	DCON MS
	(inch)	(mm)	(inch)			
A1233/32S	3/32	2.38	0.0937	14.0	43.0	2.38
A1232.5S	–	2.50	0.0984	14.0	43.0	2.50
A1233.0S	–	3.00	0.1181	16.0	46.0	3.00
A1231/8S	1/8	3.18	0.1250	18.0	49.0	3.18
A1233.2S	–	3.20	0.1260	18.0	49.0	3.20
A1233.3S	–	3.30	0.1299	18.0	49.0	3.30
A1233.5S	–	3.50	0.1378	18.0	52.0	3.50
A1233.7S	–	3.70	0.1457	18.0	52.0	3.70
A1235/32S	5/32	3.97	0.1563	18.0	55.0	3.97
A1234.0S	–	4.00	0.1575	18.0	55.0	4.00
A1234.1S	–	4.10	0.1614	18.0	55.0	4.10
A1234.2S	–	4.20	0.1654	18.0	55.0	4.20
A1234.5S	–	4.50	0.1772	18.0	58.0	4.50
A1233/16S	3/16	4.76	0.1875	18.0	62.0	4.76
A1234.8S	–	4.80	0.1890	18.0	62.0	4.80
A1234.9S	–	4.90	0.1929	18.0	62.0	4.90
A1235.0S	–	5.00	0.1969	18.0	62.0	5.00
A1235.5S	–	5.50	0.2165	18.0	66.0	5.50
A1237/32S	7/32	5.56	0.2188	18.0	66.0	5.56
A1236.0S	–	6.00	0.2362	18.0	66.0	6.00
A1231/4S	1/4	6.35	0.2500	19.0	70.0	6.35

A120



Broca HSS Serie Extra Corta, Acabado Templado al Vapor

Broca versátil con acabado templado al vapor. La punta dividida a 135° reduce las fuerzas al taladrar y evita que la broca se desplace sobre la superficie del material. El acabado templado al vapor retiene el fluido de corte y evita la soldadura de la viruta a la herramienta. Apta para taladrar muchos materiales tanto en taladros manuales como en máquinas.

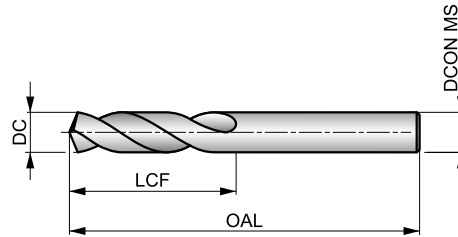

HSS	DIN 1897	2.5xD
135°	ST	
λ 20-35°	R	DC h8

Grupo de Material de la pieza adecuado y condiciones de velocidad de corte iniciales (m/min) y código de avance alfabético. Tablas con avance por revolución a partir de la pag.274.

P1.1 ■ 36 J	P1.2 ■ 40 J	P1.3 ■ 41 J	P2.1 ■ 31 J	P2.2 ■ 27 G	P2.3 ■ 24 F	P3.1 ■ 21 G	P3.2 ■ 17 G	P3.3 ■ 14 F	P4.1 ■ 12 G	P4.2 ■ 10 F	P4.3 ■ 9 E	M1.1 ■ 22 F	M1.2 ■ 19 F
M2.1 ■ 20 F	M2.2 ■ 16 F	M3.1 ■ 10 H	M3.2 ■ 9 H	M3.3 ■ 8 H	M4.1 ■ 10 D	K1.1 ■ 32 J	K1.2 ■ 24 G	K1.3 ■ 18 G	K2.1 ■ 25 F	K2.2 ■ 20 F	K2.3 ■ 16 F	K3.1 ■ 22 F	K3.2 ■ 17 F
K3.3 ■ 13 F	K4.1 ■ 20 F	K4.2 ■ 15 F	K4.3 ■ 11 F	K4.4 ■ 10 F	K4.5 ■ 8 F	K5.1 ■ 23 F	K5.2 ■ 17 F	K5.3 ■ 13 F	N1.1 ■ 33 K	N1.2 ■ 25 K	N1.3 ■ 17 J	N2.1 ■ 46 I	N2.2 ■ 42 I
N2.3 ■ 30 I	N3.1 ■ 64 I	N3.2 ■ 38 J	N3.3 ■ 19 H	N4.1 ■ 30 K	N4.2 ■ 35 I	N4.3 ■ 17 G	S1.1 ■ 27 G	S1.2 ■ 16 E	S1.3 ■ 8 C	S2.1 ■ 11 F	S2.2 ■ 6 B	S3.1 ■ 8 F	S3.2 ■ 4 B
S4.1 ■ 6 F	S4.2 ■ 3 B												

DC <= 1mm Brillante; 2.9mm => DC >= 13.0mm Punta de 118°

Product	DC (inch)	DC (mm)	DC (inch)	LCF (mm)	OAL (mm)	DCON MS (mm)
A120.5	-	0.50	0.0197	3.0	20.0	0.50
A120.6	-	0.60	0.0236	3.5	21.0	0.60
A120.7	-	0.70	0.0276	4.5	23.0	0.70
A1201/32	1/32	0.79	0.0313	5.0	24.0	0.79
A120.8	-	0.80	0.0315	5.0	24.0	0.80
A120.9	-	0.90	0.0354	5.5	25.0	0.90
A1201.0	-	1.00	0.0394	6.0	26.0	1.00
A1201.1	-	1.10	0.0433	7.0	28.0	1.10
A1201.2	-	1.20	0.0472	8.0	30.0	1.20
A1201.3	-	1.30	0.0512	8.0	30.0	1.30
A1201.4	-	1.40	0.0551	9.0	32.0	1.40
A1201.5	-	1.50	0.0591	9.0	32.0	1.50
A1201/16	1/16	1.59	0.0625	10.0	34.0	1.59
A1201.6	-	1.60	0.0630	10.0	34.0	1.60
A1201.7	-	1.70	0.0669	10.0	34.0	1.70
A1201.8	-	1.80	0.0709	11.0	36.0	1.80
A1201.9	-	1.90	0.0748	11.0	36.0	1.90
A1205/64	5/64	1.98	0.0781	12.0	38.0	1.98
A1202.0	-	2.00	0.0787	12.0	38.0	2.00
A1202.1	-	2.10	0.0827	12.0	38.0	2.10
A1202.2	-	2.20	0.0866	13.0	40.0	2.20
A1202.25	-	2.25	0.0886	13.0	40.0	2.25
A1202.3	-	2.30	0.0906	13.0	40.0	2.30

Product	DC (inch)	DC (mm)	DC (inch)	LCF (mm)	OAL (mm)	DCON MS (mm)
A1203/32	3/32	2.38	0.0938	14.0	43.0	2.38
A1202.4	-	2.40	0.0945	14.0	43.0	2.40
A1202.5	-	2.50	0.0984	14.0	43.0	2.50
A1202.6	-	2.60	0.1024	14.0	43.0	2.60
A1202.7	-	2.70	0.1063	16.0	46.0	2.70
A1207/64	7/64	2.78	0.1094	16.0	46.0	2.78
A1202.8	-	2.80	0.1102	16.0	46.0	2.80
A1202.9	-	2.90	0.1142	16.0	46.0	2.90
A1203.0	-	3.00	0.1181	16.0	46.0	3.00
A1203.1	-	3.10	0.1220	18.0	49.0	3.10
A1201/8	1/8	3.18	0.1250	18.0	49.0	3.18
A1203.2	-	3.20	0.1260	18.0	49.0	3.20
A1203.25	-	3.25	0.1280	18.0	49.0	3.25
A1203.3	-	3.30	0.1299	18.0	49.0	3.30
A1203.4	-	3.40	0.1339	20.0	52.0	3.40
A1203.5	-	3.50	0.1378	20.0	52.0	3.50
A1209/64	9/64	3.57	0.1406	20.0	52.0	3.57
A1203.6	-	3.60	0.1417	20.0	52.0	3.60
A1203.7	-	3.70	0.1457	20.0	52.0	3.70
A1203.8	-	3.80	0.1496	22.0	55.0	3.80
A1203.9	-	3.90	0.1535	22.0	55.0	3.90
A1205/32	5/32	3.97	0.1563	22.0	55.0	3.97
A1204.0	-	4.00	0.1575	22.0	55.0	4.00

Product	DC	DC	DC	LCF	OAL	DCON MS
	(inch)	(mm)	(inch)	(mm)	(mm)	(mm)
A1204.1	–	4.10	0.1614	22.0	55.0	4.10
A1204.2	–	4.20	0.1654	22.0	55.0	4.20
A1204.3	–	4.30	0.1693	24.0	58.0	4.30
A12011/64	11/64	4.37	0.1719	24.0	58.0	4.37
A1204.4	–	4.40	0.1732	24.0	58.0	4.40
A1204.5	–	4.50	0.1772	24.0	58.0	4.50
A1204.6	–	4.60	0.1811	24.0	58.0	4.60
A1204.7	–	4.70	0.1850	24.0	58.0	4.70
A1203/16	3/16	4.76	0.1875	26.0	62.0	4.76
A1204.8	–	4.80	0.1890	26.0	62.0	4.80
A1204.9	–	4.90	0.1929	26.0	62.0	4.90
A1205.0	–	5.00	0.1969	26.0	62.0	5.00
A1205.1	–	5.10	0.2008	26.0	62.0	5.10
A12013/64	13/64	5.16	0.2031	26.0	62.0	5.16
A1205.2	–	5.20	0.2047	26.0	62.0	5.20
A1205.3	–	5.30	0.2087	26.0	62.0	5.30
A1205.4	–	5.40	0.2126	28.0	66.0	5.40
A1205.5	–	5.50	0.2165	28.0	66.0	5.50
A1207/32	7/32	5.56	0.2188	28.0	66.0	5.56
A1205.6	–	5.60	0.2205	28.0	66.0	5.60
A1205.7	–	5.70	0.2244	28.0	66.0	5.70
A1205.8	–	5.80	0.2283	28.0	66.0	5.80
A1205.9	–	5.90	0.2323	28.0	66.0	5.90
A12015/64	15/64	5.95	0.2344	28.0	66.0	5.95
A1206.0	–	6.00	0.2362	28.0	66.0	6.00
A1206.1	–	6.10	0.2402	31.0	70.0	6.10
A1206.2	–	6.20	0.2441	31.0	70.0	6.20
A1206.3	–	6.30	0.2480	31.0	70.0	6.30
A1201/4	1/4	6.35	0.2500	31.0	70.0	6.35
A1206.4	–	6.40	0.2520	31.0	70.0	6.40
A1206.5	–	6.50	0.2559	31.0	70.0	6.50
A1206.6	–	6.60	0.2598	31.0	70.0	6.60
A1206.7	–	6.70	0.2638	31.0	70.0	6.70
A1206.8	–	6.80	0.2677	34.0	74.0	6.80
A1206.9	–	6.90	0.2717	34.0	74.0	6.90
A1207.0	–	7.00	0.2756	34.0	74.0	7.00
A1207.1	–	7.10	0.2795	34.0	74.0	7.10
A1209/32	9/32	7.14	0.2813	34.0	74.0	7.14
A1207.2	–	7.20	0.2835	34.0	74.0	7.20
A1207.3	–	7.30	0.2874	34.0	74.0	7.30
A1207.4	–	7.40	0.2913	34.0	74.0	7.40
A1207.5	–	7.50	0.2953	34.0	74.0	7.50
A1207.6	–	7.60	0.2992	37.0	79.0	7.60
A1207.7	–	7.70	0.3031	37.0	79.0	7.70
A1207.8	–	7.80	0.3071	37.0	79.0	7.80
A1207.9	–	7.90	0.3110	37.0	79.0	7.90
A1205/16	5/16	7.94	0.3125	37.0	79.0	7.94
A1208.0	–	8.00	0.3150	37.0	79.0	8.00
A1208.1	–	8.10	0.3189	37.0	79.0	8.10
A1208.2	–	8.20	0.3228	37.0	79.0	8.20
A1208.3	–	8.30	0.3268	37.0	79.0	8.30
A1208.4	–	8.40	0.3307	37.0	79.0	8.40
A1208.5	–	8.50	0.3346	37.0	79.0	8.50
A1208.6	–	8.60	0.3386	40.0	84.0	8.60

Product	DC	DC	DC	LCF	OAL	DCON MS
	(inch)	(mm)	(inch)	(mm)	(mm)	(mm)
A1208.7	–	8.70	0.3425	40.0	84.0	8.70
A12011/32	11/32	8.73	0.3438	40.0	84.0	8.73
A1208.8	–	8.80	0.3465	40.0	84.0	8.80
A1208.9	–	8.90	0.3504	40.0	84.0	8.90
A1209.0	–	9.00	0.3543	40.0	84.0	9.00
A1209.1	–	9.10	0.3583	40.0	84.0	9.10
A1209.2	–	9.20	0.3622	40.0	84.0	9.20
A1209.3	–	9.30	0.3661	40.0	84.0	9.30
A1209.4	–	9.40	0.3701	40.0	84.0	9.40
A1209.5	–	9.50	0.3740	40.0	84.0	9.50
A1203/8	3/8	9.52	0.3750	43.0	89.0	9.52
A1209.6	–	9.60	0.3780	43.0	89.0	9.60
A1209.7	–	9.70	0.3819	43.0	89.0	9.70
A1209.8	–	9.80	0.3858	43.0	89.0	9.80
A1209.9	–	9.90	0.3898	43.0	89.0	9.90
A12010.0	–	10.00	0.3937	43.0	89.0	10.00
A12010.1	–	10.10	0.3976	43.0	89.0	10.10
A12010.2	–	10.20	0.4016	43.0	89.0	10.20
A12010.3	–	10.30	0.4055	43.0	89.0	10.30
A12010.5	–	10.50	0.4134	43.0	89.0	10.50
A12010.8	–	10.80	0.4252	47.0	95.0	10.80
A12011.0	–	11.00	0.4331	47.0	95.0	11.00
A1207/16	7/16	11.11	0.4375	47.0	95.0	11.11
A12011.3	–	11.30	0.4449	47.0	95.0	11.30
A12011.5	–	11.50	0.4528	47.0	95.0	11.50
A12011.7	–	11.70	0.4606	47.0	95.0	11.70
A12011.8	–	11.80	0.4646	47.0	95.0	11.80
A12012.0	–	12.00	0.4724	51.0	102.0	12.00
A12012.1	–	12.10	0.4764	51.0	102.0	12.10
A12012.2	–	12.20	0.4803	51.0	102.0	12.20
A12012.5	–	12.50	0.4921	51.0	102.0	12.50
A1201/2	1/2	12.70	0.5000	51.0	102.0	12.70
A12013.0	–	13.00	0.5118	51.0	102.0	13.00
A12013.5	–	13.50	0.5315	54.0	107.0	13.50
A12014.0	–	14.00	0.5512	54.0	107.0	14.00
A1209/16	9/16	14.29	0.5625	56.0	111.0	14.29
A12014.5	–	14.50	0.5709	56.0	111.0	14.50
A12015.0	–	15.00	0.5906	56.0	111.0	15.00
A12015.5	–	15.50	0.6102	58.0	115.0	15.50
A1205/8	5/8	15.88	0.6250	58.0	115.0	15.88
A12016.0	–	16.00	0.6299	58.0	115.0	16.00
A12016.5	–	16.50	0.6496	60.0	119.0	16.50
A12017.0	–	17.00	0.6693	60.0	119.0	17.00
A12011/16	11/16	17.46	0.6875	62.0	123.0	17.46
A12017.5	–	17.50	0.6890	62.0	123.0	17.50
A12018.0	–	18.00	0.7087	62.0	123.0	18.00
A12018.5	–	18.50	0.7283	64.0	127.0	18.50
A12019.0	–	19.00	0.7480	64.0	127.0	19.00
A12020.0	–	20.00	0.7874	66.0	131.0	20.00
A12020.5	–	20.50	0.8071	68.0	136.0	20.50
A12013/16	13/16	20.64	0.8125	68.0	136.0	20.64
A12021.0	–	21.00	0.8268	68.0	136.0	21.00
A12022.0	–	22.00	0.8661	70.0	141.0	22.00
A12025.0	–	25.00	0.9843	75.0	151.0	25.00

A022



Broca HSS Serie Extra Corta, con la Punta Recubierta TiN

Broca versátil con punta dividida a 118° especialmente diseñada para ayudar a autocentrar la broca cuando se taladra a mano y en máquina proporciona un agujero de tamaño más preciso y con mejor acabado superficial. Apta para muchos materiales. El recubrimiento TiN-Tip mejora el rendimiento y prolonga la vida útil de la herramienta.

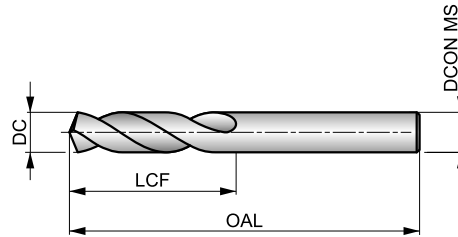

HSS	DIN ANSI	2.5xD
135°	TiN-Tip	
λ 20-35°	R	DC h8

Grupo de Material de la pieza adecuado y condiciones de velocidad de corte iniciales (m/min) y código de avance alfabético. Tablas con avance por revolución a partir de la pag.274.

P1.1 ■ 33 K	P1.2 ■ 37 K	P1.3 ■ 38 K	P2.1 ■ 28 K	P2.2 ■ 25 I	P2.3 ■ 22 G	P3.1 ■ 24 H	P3.2 ■ 19 H	P3.3 ■ 16 G	P4.1 ■ 14 H	P4.2 ■ 12 G	P4.3 □ 10 E	M1.1 ■ 21 G	M1.2 ■ 17 G
M2.1 ■ 18 G	M2.2 ■ 15 G	M3.1 □ 9 I	M3.2 □ 8 I	M3.3 □ 7 I	M4.1 □ 9 E	K1.1 ■ 32 K	K1.2 ■ 24 I	K1.3 ■ 18 I	K2.1 ■ 25 G	K2.2 ■ 20 G	K2.3 □ 16 G	K3.1 ■ 22 G	K3.2 ■ 17 G
K3.3 □ 13 G	K4.1 ■ 20 G	K4.2 ■ 15 G	K4.3 □ 11 G	K4.4 □ 10 G	K4.5 □ 8 G	K5.1 ■ 23 G	K5.2 ■ 17 G	K5.3 □ 13 G	N1.1 ■ 40 F	N1.2 ■ 30 F	N1.3 ■ 20 K	N2.1 ■ 49 J	N2.2 ■ 44 J
N2.3 ■ 32 J	N3.1 □ 64 I	N3.2 □ 38 K	N3.3 □ 19 H	N4.1 □ 30 K	N4.2 □ 35 I	N4.3 □ 17 G	S1.1 ■ 25 I	S1.2 □ 14 F	S1.3 □ 8 C	S2.1 □ 11 F	S2.2 □ 6 B	S3.1 □ 8 F	S3.2 □ 4 B
S4.1 □ 6 F	S4.2 □ 3 B												

DC < 2mm Brillante; DC >= 2mm Punta rectificada en cruz y recubierta TiN
Los productos de esta serie también están disponibles en forma de Set. Por favor, vea A088.

Product	DC (inch)	DC (mm)	DC (inch)	LCF (mm)	OAL (mm)	DCON MS (mm)
A022.5	-	0.50	0.0197	3.0	20.0	0.50
A022.6	-	0.60	0.0236	3.5	21.0	0.60
A022.7	-	0.70	0.0276	4.5	23.0	0.70
A0221/32	1/32	0.79	0.0313	13.0	35.0	0.79
A022.8	-	0.80	0.0315	5.0	24.0	0.80
A022.9	-	0.90	0.0354	5.5	25.0	0.90
A0221.0	-	1.00	0.0394	6.0	26.0	1.00
A0221.1	-	1.10	0.0433	7.0	28.0	1.10
A0223/64	3/64	1.19	0.0469	13.0	35.0	1.19
A0221.2	-	1.20	0.0472	8.0	30.0	1.20
A0221.3	-	1.30	0.0512	8.0	30.0	1.30
A0221.4	-	1.40	0.0551	9.0	32.0	1.40
A0221.5	-	1.50	0.0591	9.0	32.0	1.50
A0221/16	1/16	1.59	0.0625	16.0	41.0	1.59
A0221.6	-	1.60	0.0630	10.0	34.0	1.60
A0221.7	-	1.70	0.0669	10.0	34.0	1.70
A0221.8	-	1.80	0.0709	11.0	36.0	1.80
A0221.9	-	1.90	0.0748	11.0	36.0	1.90
A0225/64	5/64	1.98	0.0781	17.0	43.0	1.98
A0222.0	-	2.00	0.0787	12.0	38.0	2.00
A0222.1	-	2.10	0.0827	12.0	38.0	2.10
A0222.2	-	2.20	0.0866	13.0	40.0	2.20

Product	DC (inch)	DC (mm)	DC (inch)	LCF (mm)	OAL (mm)	DCON MS (mm)
A0222.25	-	2.25	0.0886	13.0	40.0	2.25
A0222.3	-	2.30	0.0906	13.0	40.0	2.30
A0223/32	3/32	2.38	0.0938	20.0	45.0	2.38
A0222.4	-	2.40	0.0945	14.0	43.0	2.40
A0222.5	-	2.50	0.0984	14.0	43.0	2.50
A0222.6	-	2.60	0.1024	14.0	43.0	2.60
A0222.65	-	2.65	0.1043	14.0	43.0	2.65
A0222.7	-	2.70	0.1063	16.0	46.0	2.70
A0227/64	7/64	2.78	0.1094	22.0	47.0	2.78
A0222.8	-	2.80	0.1102	16.0	46.0	2.80
A0222.9	-	2.90	0.1142	16.0	46.0	2.90
A0223.0	-	3.00	0.1181	16.0	46.0	3.00
A0223.1	-	3.10	0.1220	18.0	49.0	3.10
A0221/8	1/8	3.18	0.1250	23.0	49.0	3.18
A0223.2	-	3.20	0.1260	18.0	49.0	3.20
A0223.25	-	3.25	0.1280	18.0	49.0	3.25
A0223.3	-	3.30	0.1299	18.0	49.0	3.30
A0223.4	-	3.40	0.1339	20.0	52.0	3.40
A0223.5	-	3.50	0.1378	20.0	52.0	3.50
A0229/64	9/64	3.57	0.1406	25.0	50.0	3.57
A0223.6	-	3.60	0.1417	20.0	52.0	3.60
A0223.7	-	3.70	0.1457	20.0	52.0	3.70

Product	DC	DC	DC	LCF	OAL	DCON MS
	(inch)	(mm)	(inch)	(mm)	(mm)	(mm)
A0223.8	–	3.80	0.1496	22.0	55.0	3.80
A0223.9	–	3.90	0.1535	22.0	55.0	3.90
A0225/32	5/32	3.97	0.1563	26.0	53.0	3.97
A0224.0	–	4.00	0.1575	22.0	55.0	4.00
A0224.1	–	4.10	0.1614	22.0	55.0	4.10
A0224.2	–	4.20	0.1654	22.0	55.0	4.20
A0224.3	–	4.30	0.1693	24.0	58.0	4.30
A02211/64	11/64	4.37	0.1719	28.0	55.0	4.37
A0224.4	–	4.40	0.1732	24.0	58.0	4.40
A0224.5	–	4.50	0.1772	24.0	58.0	4.50
A0224.6	–	4.60	0.1811	24.0	58.0	4.60
A0224.7	–	4.70	0.1850	24.0	58.0	4.70
A0223/16	3/16	4.76	0.1875	30.0	57.0	4.76
A0224.8	–	4.80	0.1890	26.0	62.0	4.80
A0224.9	–	4.90	0.1929	26.0	62.0	4.90
A0225.0	–	5.00	0.1969	26.0	62.0	5.00
A0225.1	–	5.10	0.2008	26.0	62.0	5.10
A02213/64	13/64	5.16	0.2031	31.0	58.0	5.16
A0225.2	–	5.20	0.2047	26.0	62.0	5.20
A0225.3	–	5.30	0.2087	26.0	62.0	5.30
A0225.4	–	5.40	0.2126	28.0	66.0	5.40
A0225.5	–	5.50	0.2165	28.0	66.0	5.50
A0227/32	7/32	5.56	0.2188	33.0	61.0	5.56
A0225.6	–	5.60	0.2205	28.0	66.0	5.60
A0225.7	–	5.70	0.2244	28.0	66.0	5.70
A0225.8	–	5.80	0.2283	28.0	66.0	5.80
A0225.9	–	5.90	0.2323	28.0	66.0	5.90
A02215/64	15/64	5.95	0.2344	34.0	63.0	5.95
A0226.0	–	6.00	0.2362	28.0	66.0	6.00
A0226.1	–	6.10	0.2402	31.0	70.0	6.10
A0226.2	–	6.20	0.2441	31.0	70.0	6.20
A0226.3	–	6.30	0.2480	31.0	70.0	6.30
A0221/4	1/4	6.35	0.2500	36.0	65.0	6.35
A0226.4	–	6.40	0.2520	31.0	70.0	6.40
A0226.5	–	6.50	0.2559	31.0	70.0	6.50
A0226.6	–	6.60	0.2598	31.0	70.0	6.60
A0226.7	–	6.70	0.2638	31.0	70.0	6.70
A0226.8	–	6.80	0.2677	34.0	74.0	6.80
A0226.9	–	6.90	0.2717	34.0	74.0	6.90
A0227.0	–	7.00	0.2756	34.0	74.0	7.00
A0227.1	–	7.10	0.2795	34.0	74.0	7.10
A0229/32	9/32	7.14	0.2813	40.0	70.0	7.14
A0227.2	–	7.20	0.2835	34.0	74.0	7.20
A0227.3	–	7.30	0.2874	34.0	74.0	7.30
A0227.4	–	7.40	0.2913	34.0	74.0	7.40
A0227.5	–	7.50	0.2953	34.0	74.0	7.50
A0227.6	–	7.60	0.2992	37.0	79.0	7.60
A0227.7	–	7.70	0.3031	37.0	79.0	7.70
A0227.8	–	7.80	0.3071	37.0	79.0	7.80
A0227.9	–	7.90	0.3110	37.0	79.0	7.90
A0225/16	5/16	7.94	0.3125	43.0	73.0	7.94
A0228.0	–	8.00	0.3150	37.0	79.0	8.00
A0228.1	–	8.10	0.3189	37.0	79.0	8.10

Product	DC	DC	DC	LCF	OAL	DCON MS
	(inch)	(mm)	(inch)	(mm)	(mm)	(mm)
A0228.2	–	8.20	0.3228	37.0	79.0	8.20
A0228.3	–	8.30	0.3268	37.0	79.0	8.30
A0228.4	–	8.40	0.3307	37.0	79.0	8.40
A0228.5	–	8.50	0.3346	37.0	79.0	8.50
A0228.6	–	8.60	0.3386	40.0	84.0	8.60
A0228.7	–	8.70	0.3425	40.0	84.0	8.70
A02211/32	11/32	8.73	0.3438	45.0	78.0	8.73
A0228.8	–	8.80	0.3465	40.0	84.0	8.80
A0228.9	–	8.90	0.3504	40.0	84.0	8.90
A0229.0	–	9.00	0.3543	40.0	84.0	9.00
A0229.1	–	9.10	0.3583	40.0	84.0	9.10
A0229.2	–	9.20	0.3622	40.0	84.0	9.20
A0229.3	–	9.30	0.3661	40.0	84.0	9.30
A0229.4	–	9.40	0.3701	40.0	84.0	9.40
A0229.5	–	9.50	0.3740	40.0	84.0	9.50
A0223/8	3/8	9.52	0.3750	48.0	81.0	9.52
A0229.6	–	9.60	0.3780	43.0	89.0	9.60
A0229.7	–	9.70	0.3819	43.0	89.0	9.70
A0229.8	–	9.80	0.3858	43.0	89.0	9.80
A0229.9	–	9.90	0.3898	43.0	89.0	9.90
A02210.0	–	10.00	0.3937	43.0	89.0	10.00
A02210.1	–	10.10	0.3976	43.0	89.0	10.10
A02210.2	–	10.20	0.4016	43.0	89.0	10.20
A02210.3	–	10.30	0.4055	43.0	89.0	10.30
A02213/32	13/32	10.32	0.4063	51.0	86.0	10.32
A02210.4	–	10.40	0.4094	43.0	89.0	10.40
A02210.5	–	10.50	0.4134	43.0	89.0	10.50
A02210.6	–	10.60	0.4173	43.0	89.0	10.60
A02210.8	–	10.80	0.4252	47.0	95.0	10.80
A02211.0	–	11.00	0.4331	47.0	95.0	11.00
A02211.1	–	11.10	0.4370	47.0	95.0	11.10
A0227/16	7/16	11.11	0.4375	54.0	89.0	11.11
A02211.2	–	11.20	0.4409	47.0	95.0	11.20
A02211.3	–	11.30	0.4449	47.0	95.0	11.30
A02211.5	–	11.50	0.4528	47.0	95.0	11.50
A02211.7	–	11.70	0.4606	47.0	95.0	11.70
A02211.8	–	11.80	0.4646	47.0	95.0	11.80
A02211.9	–	11.90	0.4685	51.0	102.0	11.90
A02212.0	–	12.00	0.4724	51.0	102.0	12.00
A02212.1	–	12.10	0.4764	51.0	102.0	12.10
A02212.2	–	12.20	0.4803	51.0	102.0	12.20
A02212.5	–	12.50	0.4921	51.0	102.0	12.50
A0221/2	1/2	12.70	0.5000	60.0	98.0	12.70
A02213.0	–	13.00	0.5118	51.0	102.0	13.00
A02213.5	–	13.50	0.5315	54.0	107.0	13.50
A02214.0	–	14.00	0.5512	54.0	107.0	14.00
A0229/16	9/16	14.29	0.5625	67.0	105.0	14.29
A02214.5	–	14.50	0.5709	56.0	111.0	14.50
A02215.0	–	15.00	0.5906	56.0	111.0	15.00
A02215.5	–	15.50	0.6102	58.0	115.0	15.50
A0225/8	5/8	15.88	0.6250	73.0	111.0	15.88
A02216.0	–	16.00	0.6299	58.0	115.0	16.00

Código de Material (BMC)	HSS	HSS	HSS	HSS	HSS	HSS	HSS	HSS										
Grupo básico estándar (BSG)		DIN 338	DIN 338		DIN 345	DIN 338	DIN 338	DIN 338										
Longitud Útil (ULDR)	3.5xD	4xD	4xD	4xD	4xD	4xD	4xD	4xD										
Ángulo de aplicación																		
Recubrimiento																		
Mango																		
Forma de la Hélice																		
Mano (dirección de corte)																		

NEW

Código de Familia de Producto		A321	A100	A101	A170	A130	A002	A002S	A108									
Gama de diámetros de corte PSF		3.0 - 13.0	0.20 - 20.00	1.00 - 12.00	13.00 - 1.1/4	3.00 - 2"	1.00 - 16.00	2.00 - 13.00	1.00 - 16.00									
P	P1	■	■	■	■	■	■	■	■									
	P2	■	■	■	■	■	■	■	■									
	P3	■	■	■	■	■	■	■	■									
	P4	■	■	■	■	■	■	■	■	■								
M	M1	■	■	■	■	■	■	■	■									
	M2	■	■	■	■	■	■	■	■									
	M3	■	■	■	■	■	■	■	■									
	M4	■	■	■	■	■	■	■	■	■								
K	K1	■	■	■	■	■	■	■	■									
	K2	■	■	■	■	■	■	■	■									
	K3	■	■	■	■	■	■	■	■									
	K4	■	■	■	■	■	■	■	■									
	K5	■	■	■	■	■	■	■	■									
N	N1	■	■	■	■	■	■	■	■									
	N2	■	■	■	■	■	■	■	■									
	N3	■	■	■	■	■	■	■	■									
	N4	■	■	■	■	■	■	■	■									
	N5	■	■	■	■	■	■	■	■									
S	S1	■	■	■	■	■	■	■	■									
	S2	■	■	■	■	■	■	■	■									
	S3	■	■	■	■	■	■	■	■									
	S4	■	■	■	■	■	■	■	■									
H	H1																	
	H2																	
	H3																	
	H4																	

A321



Broca HSS de longitud intermedia, acabado superficial vaporizado y bronce

Broca de diseño resistente con mango provisto de tres caras planas, para agujeros de profundidad media. Adecuada principalmente para aplicaciones manuales y taladros de columna. Gracias a las tres caras planas del mango, encaja en el portabrocas sin deslizarse. La punta dividida de 135° con autocentrado reduce la fuerza de empuje y el acabado superficial vaporizado y bronce mejora la lubricación.

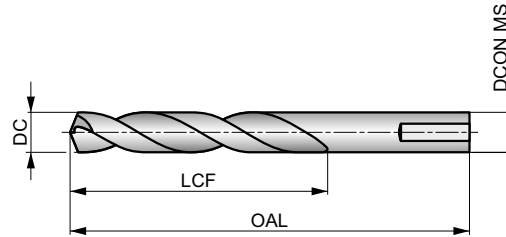

HSS	DORMER	3.5xD
135°	ST Bronze	
R	DC h8	

Grupo de Material de la pieza adecuado y condiciones de velocidad de corte iniciales (m/min) y código de avance alfabético. Tablas con avance por revolución a partir de la pag.274.

P1.1 ■ 33 H	P1.2 ■ 37 H	P1.3 ■ 38 H	P2.1 ■ 28 H	P2.2 ■ 25 F	P2.3 ■ 22 E	P3.1 ■ 19 F	P3.2 ■ 15 F	P3.3 ■ 13 E	P4.1 ■ 11 F	P4.2 ■ 10 E	P4.3 ■ 8 D	M1.1 ■ 21 E	M1.2 ■ 17 E
M2.1 ■ 18 E	M2.2 ■ 15 E	M3.1 ■ 9 G	M3.2 ■ 8 G	M3.3 ■ 7 G	M4.1 ■ 9 C	K1.1 ■ 30 H	K1.2 ■ 22 F	K1.3 ■ 17 F	K2.1 ■ 25 E	K2.2 ■ 20 E	K2.3 ■ 16 E	K3.1 ■ 22 E	K3.2 ■ 17 E
K3.3 ■ 13 E	K4.1 ■ 20 E	K4.2 ■ 15 E	K4.3 ■ 11 E	K4.4 ■ 10 E	K4.5 ■ 8 E	K5.1 ■ 23 E	K5.2 ■ 17 E	K5.3 ■ 13 E	N1.1 ■ 33 J	N1.2 ■ 25 J	N1.3 ■ 17 I	N2.1 ■ 42 H	N2.2 ■ 37 H
N2.3 ■ 27 H	N3.1 ■ 59 H	N3.2 ■ 35 I	N3.3 ■ 18 G	N4.1 ■ 30 J	N4.2 ■ 28 H	N4.3 ■ 14 F	S1.1 ■ 23 E	S1.2 ■ 12 D	S1.3 ■ 6 B	S2.1 ■ 8 E	S2.2 ■ 4 A	S3.1 ■ 6 E	S3.2 ■ 3 A
S4.1 ■ 5 E	S4.2 ■ 2 A												

Product	DC (mm)	DC (inch)	LCF (mm)	OAL (mm)	DCON MS (mm)
A3213.0	3.00	0.1180	37.0	64.0	3.00
A3213.3	3.30	0.1300	40.0	67.0	3.30
A3213.4	3.40	0.1340	40.0	67.0	3.40
A3213.5	3.50	0.1380	40.0	67.0	3.50
A3214.0	4.00	0.1580	47.0	74.0	4.00
A3214.1	4.10	0.1610	47.0	74.0	4.10
A3214.2	4.20	0.1650	47.0	74.0	4.20
A3214.3	4.30	0.1690	47.0	74.0	4.30
A3214.5	4.50	0.1770	49.0	77.0	4.50
A3214.9	4.90	0.1930	50.0	80.0	4.90
A3215.0	5.00	0.1970	50.0	80.0	5.00
A3215.1	5.10	0.2010	50.0	80.0	5.10
A3215.3	5.30	0.2090	52.0	84.0	5.30
A3215.5	5.50	0.2170	52.0	84.0	5.50
A3216.0	6.00	0.2360	52.0	90.0	6.00
A3216.3	6.30	0.2480	52.0	90.0	6.30
A3216.5	6.50	0.2560	55.0	93.0	6.50

Product	DC (mm)	DC (inch)	LCF (mm)	OAL (mm)	DCON MS (mm)
A3216.8	6.80	0.2680	59.0	97.0	6.80
A3217.0	7.00	0.2760	59.0	97.0	7.00
A3217.3	7.30	0.2870	62.0	100.0	7.30
A3217.5	7.50	0.2950	62.0	100.0	7.50
A3218.0	8.00	0.3150	67.0	105.0	8.00
A3218.5	8.50	0.3350	68.0	107.0	8.50
A3219.0	9.00	0.3540	70.0	108.0	9.00
A3219.5	9.50	0.3740	70.0	110.0	9.50
A32110.0	10.00	0.3940	74.0	113.0	10.00
A32110.3	10.30	0.4060	74.0	113.0	10.30
A32110.5	10.50	0.4130	75.0	115.0	10.50
A32111.0	11.00	0.4330	77.0	117.0	11.00
A32111.5	11.50	0.4530	79.0	120.0	11.50
A32112.0	12.00	0.4720	85.0	126.0	12.00
A32112.5	12.50	0.4920	88.0	130.0	12.50
A32113.0	13.00	0.5120	88.0	130.0	13.00

A100



Broca HSS Serie Corta, con Acabado Templado al Vapor

Un gran broca versátil todoterreno con punta convencional a 118°, que proporciona gran resistencia y es fácil de reafilarse, lo que lo hace muy rentable. Utilizable en aplicaciones manuales y en máquinas. El acabado templado al vapor retiene el fluido de corte y evita la soldadura de la viruta a la herramienta. Adecuada para la mayoría de materiales.

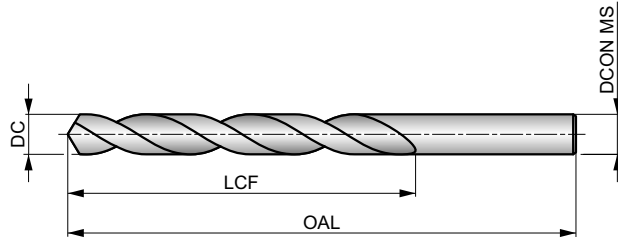

HSS	DIN 338	4×D
118°	ST	
λ 20-35°	R	DC h8

Grupo de Material de la pieza adecuado y condiciones de velocidad de corte iniciales (m/min) y código de avance alfabético. Tablas con avance por revolución a partir de la pag.274.

P1.1 ■ 33 H	P1.2 ■ 37 H	P1.3 ■ 38 H	P2.1 ■ 28 H	P2.2 ■ 25 F	P2.3 ■ 22 E	P3.1 ■ 19 F	P3.2 ■ 15 F	P3.3 ■ 13 E	P4.1 ■ 11 F	P4.2 ■ 10 E	P4.3 ■ 8 D	M1.1 ■ 21 E	M1.2 ■ 17 E
M2.1 ■ 18 E	M2.2 ■ 15 E	M3.1 ■ 9 G	M3.2 ■ 8 G	M3.3 ■ 7 G	M4.1 ■ 9 C	K1.1 ■ 30 H	K1.2 ■ 22 F	K1.3 ■ 17 F	K2.1 ■ 25 E	K2.2 ■ 20 E	K2.3 ■ 16 E	K3.1 ■ 22 E	K3.2 ■ 17 E
K3.3 ■ 13 E	K4.1 ■ 20 E	K4.2 ■ 15 E	K4.3 ■ 11 E	K4.4 ■ 10 E	K4.5 ■ 8 E	K5.1 ■ 23 E	K5.2 ■ 17 E	K5.3 ■ 13 E	N1.1 ■ 33 J	N1.2 ■ 25 J	N1.3 ■ 17 I	N2.1 ■ 42 H	N2.2 ■ 37 H
N2.3 ■ 27 H	N3.1 ■ 59 H	N3.2 ■ 35 I	N3.3 ■ 18 G	N4.1 ■ 30 J	N4.2 ■ 28 H	N4.3 ■ 14 F	S1.1 ■ 23 E	S1.2 ■ 12 D	S1.3 ■ 6 B	S2.1 ■ 8 E	S2.2 ■ 4 A	S3.1 ■ 6 E	S3.2 ■ 3 A
S4.1 ■ 5 E	S4.2 ■ 2 A												

DC <= 1mm; 3/64"; N60. Brillante

Los productos de esta serie también están disponibles en forma de Set. Por favor, vea A190 o A191.

Product	DC (inch)	DC (mm)	DC (inch)	LCF (mm)	OAL (mm)	DCON MS (mm)
A100.2	—	0.20	0.0079	2.5	19.0	0.20
A100.25	—	0.25	0.0098	3.0	19.0	0.25
A100.3	—	0.30	0.0118	3.0	19.0	0.30
A100.32	—	0.32	0.0126	4.0	19.0	0.32
A100N80	N80	0.34	0.0135	4.0	19.0	0.34
A100.35	—	0.35	0.0138	4.0	19.0	0.35
A100N79	N79	0.37	0.0145	4.0	19.0	0.37
A100.38	—	0.38	0.0150	4.0	19.0	0.38
A1001/64	1/64	0.40	0.0156	5.0	20.0	0.40
A100.4	—	0.40	0.0157	5.0	20.0	0.40
A100N78	N78	0.41	0.0160	5.0	20.0	0.41
A100.42	—	0.42	0.0165	5.0	20.0	0.42
A100.45	—	0.45	0.0177	5.0	20.0	0.45
A100N77	N77	0.46	0.0180	5.0	20.0	0.46
A100.48	—	0.48	0.0189	5.0	20.0	0.48
A100.5	—	0.50	0.0197	6.0	22.0	0.50
A100N76	N76	0.51	0.0200	6.0	22.0	0.51
A100.52	—	0.52	0.0205	6.0	22.0	0.52
A100N75	N75	0.53	0.0210	6.0	22.0	0.53
A100.55	—	0.55	0.0217	7.0	24.0	0.55
A100N74	N74	0.57	0.0225	7.0	24.0	0.57
A100.58	—	0.58	0.0228	7.0	24.0	0.58

Product	DC (inch)	DC (mm)	DC (inch)	LCF (mm)	OAL (mm)	DCON MS (mm)
A100.6	—	0.60	0.0236	7.0	24.0	0.60
A100N73	N73	0.61	0.0240	8.0	26.0	0.61
A100.62	—	0.62	0.0244	8.0	26.0	0.62
A100N72	N72	0.64	0.0250	8.0	26.0	0.64
A100.65	—	0.65	0.0256	8.0	26.0	0.65
A100N71	N71	0.66	0.0260	8.0	26.0	0.66
A100.68	—	0.68	0.0268	9.0	28.0	0.68
A100.7	—	0.70	0.0276	9.0	28.0	0.70
A100N70	N70	0.71	0.0280	9.0	28.0	0.71
A100.72	—	0.72	0.0283	9.0	28.0	0.72
A100N69	N69	0.74	0.0292	9.0	28.0	0.74
A100.75	—	0.75	0.0295	9.0	28.0	0.75
A100.78	—	0.78	0.0307	10.0	30.0	0.78
A1001/32	1/32	0.79	0.0313	10.0	30.0	0.79
A100N68	N68	0.79	0.0310	10.0	30.0	0.79
A100.8	—	0.80	0.0315	10.0	30.0	0.80
A100N67	N67	0.81	0.0320	10.0	30.0	0.81
A100.82	—	0.82	0.0323	10.0	30.0	0.82
A100N66	N66	0.84	0.0330	10.0	30.0	0.84
A100.85	—	0.85	0.0335	10.0	30.0	0.85
A100.88	—	0.88	0.0346	11.0	32.0	0.88
A100N65	N65	0.89	0.0350	11.0	32.0	0.89

Product	DC	DC	DC	LCF	OAL	DCON MS
	(inch)	(mm)	(inch)	(mm)	(mm)	(mm)
A100.9	–	0.90	0.0354	11.0	32.0	0.90
A100N64	N64	0.91	0.0360	11.0	32.0	0.91
A100.92	–	0.92	0.0362	11.0	32.0	0.92
A100N63	N63	0.94	0.0370	11.0	32.0	0.94
A100.95	–	0.95	0.0374	11.0	32.0	0.95
A100N62	N62	0.97	0.0380	12.0	34.0	0.97
A100.98	–	0.98	0.0386	12.0	34.0	0.98
A100N61	N61	0.99	0.0390	12.0	34.0	0.99
A1001.0	–	1.00	0.0394	12.0	34.0	1.00
A100N60	N60	1.02	0.0400	12.0	34.0	1.02
A100N59	N59	1.04	0.0410	12.0	34.0	1.04
A1001.05	–	1.05	0.0413	12.0	34.0	1.05
A100N58	N58	1.07	0.0420	14.0	36.0	1.07
A100N57	N57	1.09	0.0430	14.0	36.0	1.09
A1001.1	–	1.10	0.0433	14.0	36.0	1.10
A1001.15	–	1.15	0.0453	14.0	36.0	1.15
A100N56	N56	1.18	0.0465	14.0	36.0	1.18
A1003/64	3/64	1.19	0.0469	16.0	38.0	1.19
A1001.2	–	1.20	0.0472	16.0	38.0	1.20
A1001.25	–	1.25	0.0492	16.0	38.0	1.25
A1001.3	–	1.30	0.0512	16.0	38.0	1.30
A100N55	N55	1.32	0.0520	16.0	38.0	1.32
A1001.35	–	1.35	0.0531	18.0	40.0	1.35
A1001.4	–	1.40	0.0551	18.0	40.0	1.40
A100N54	N54	1.40	0.0550	18.0	40.0	1.40
A1001.45	–	1.45	0.0571	18.0	40.0	1.45
A1001.5	–	1.50	0.0591	18.0	40.0	1.50
A100N53	N53	1.51	0.0595	20.0	43.0	1.51
A1001.55	–	1.55	0.0610	20.0	43.0	1.55
A1001/16	1/16	1.59	0.0625	20.0	43.0	1.59
A1001.6	–	1.60	0.0630	20.0	43.0	1.60
A100N52	N52	1.61	0.0635	20.0	43.0	1.61
A1001.65	–	1.65	0.0650	20.0	43.0	1.65
A1001.7	–	1.70	0.0669	20.0	43.0	1.70
A100N51	N51	1.70	0.0670	22.0	46.0	1.70
A1001.75	–	1.75	0.0689	22.0	46.0	1.75
A100N50	N50	1.78	0.0700	22.0	46.0	1.78
A1001.8	–	1.80	0.0709	22.0	46.0	1.80
A1001.85	–	1.85	0.0728	22.0	46.0	1.85
A100N49	N49	1.85	0.0730	22.0	46.0	1.85
A1001.9	–	1.90	0.0748	22.0	46.0	1.90
A100N48	N48	1.93	0.0760	24.0	49.0	1.93
A1001.95	–	1.95	0.0768	24.0	49.0	1.95
A1005/64	5/64	1.98	0.0781	24.0	49.0	1.98
A100N47	N47	1.99	0.0785	24.0	49.0	1.99
A1002.0	–	2.00	0.0787	24.0	49.0	2.00
A1002.05	–	2.05	0.0807	24.0	49.0	2.05
A100N46	N46	2.06	0.0810	24.0	49.0	2.06
A100N45	N45	2.08	0.0820	24.0	49.0	2.08
A1002.1	–	2.10	0.0827	24.0	49.0	2.10
A1002.15	–	2.15	0.0846	27.0	53.0	2.15
A100N44	N44	2.18	0.0860	27.0	53.0	2.18
A1002.2	–	2.20	0.0866	27.0	53.0	2.20
A1002.25	–	2.25	0.0886	27.0	53.0	2.25
A100N43	N43	2.26	0.0890	27.0	53.0	2.26
A1002.3	–	2.30	0.0906	27.0	53.0	2.30
A1002.35	–	2.35	0.0925	27.0	53.0	2.35
A1003/32	3/32	2.38	0.0938	30.0	57.0	2.38
A100N42	N42	2.38	0.0935	30.0	57.0	2.38
A1002.4	–	2.40	0.0945	30.0	57.0	2.40
A100N41	N41	2.44	0.0960	30.0	57.0	2.44
A1002.45	–	2.45	0.0965	30.0	57.0	2.45

Product	DC	DC	DC	LCF	OAL	DCON MS
	(inch)	(mm)	(inch)	(mm)	(mm)	(mm)
A100N40	N40	2.49	0.0980	30.0	57.0	2.49
A1002.5	–	2.50	0.0984	30.0	57.0	2.50
A100N39	N39	2.53	0.0995	30.0	57.0	2.53
A1002.55	–	2.55	0.1004	30.0	57.0	2.55
A100N38	N38	2.58	0.1015	30.0	57.0	2.58
A1002.6	–	2.60	0.1024	30.0	57.0	2.60
A100N37	N37	2.64	0.1040	30.0	57.0	2.64
A1002.65	–	2.65	0.1043	30.0	57.0	2.65
A1002.7	–	2.70	0.1063	33.0	61.0	2.70
A100N36	N36	2.71	0.1065	33.0	61.0	2.71
A1002.75	–	2.75	0.1083	33.0	61.0	2.75
A1007/64	7/64	2.78	0.1094	33.0	61.0	2.78
A100N35	N35	2.79	0.1100	33.0	61.0	2.79
A1002.8	–	2.80	0.1102	33.0	61.0	2.80
A100N34	N34	2.82	0.1110	33.0	61.0	2.82
A1002.85	–	2.85	0.1122	33.0	61.0	2.85
A100N33	N33	2.87	0.1130	33.0	61.0	2.87
A1002.9	–	2.90	0.1142	33.0	61.0	2.90
A1002.95	–	2.95	0.1161	33.0	61.0	2.95
A100N32	N32	2.95	0.1160	33.0	61.0	2.95
A1003.0	–	3.00	0.1181	33.0	61.0	3.00
A100N31	N31	3.05	0.1200	36.0	65.0	3.05
A1003.1	–	3.10	0.1220	36.0	65.0	3.10
A1003.15	–	3.15	0.1240	36.0	65.0	3.15
A1001/8	1/8	3.18	0.1250	36.0	65.0	3.18
A1003.2	–	3.20	0.1260	36.0	65.0	3.20
A1003.25	–	3.25	0.1280	36.0	65.0	3.25
A100N30	N30	3.26	0.1285	36.0	65.0	3.26
A1003.3	–	3.30	0.1299	36.0	65.0	3.30
A1003.4	–	3.40	0.1339	39.0	70.0	3.40
A100N29	N29	3.45	0.1360	39.0	70.0	3.45
A1003.5	–	3.50	0.1378	39.0	70.0	3.50
A1009/64	9/64	3.57	0.1406	39.0	70.0	3.57
A100N28	N28	3.57	0.1405	39.0	70.0	3.57
A1003.6	–	3.60	0.1417	39.0	70.0	3.60
A100N27	N27	3.66	0.1440	39.0	70.0	3.66
A1003.7	–	3.70	0.1457	39.0	70.0	3.70
A100N26	N26	3.73	0.1470	39.0	70.0	3.73
A1003.75	–	3.75	0.1476	39.0	70.0	3.75
A1003.8	–	3.80	0.1496	43.0	75.0	3.80
A100N25	N25	3.80	0.1495	43.0	75.0	3.80
A100N24	N24	3.86	0.1520	43.0	75.0	3.86
A1003.9	–	3.90	0.1535	43.0	75.0	3.90
A100N23	N23	3.91	0.1540	43.0	75.0	3.91
A1005/32	5/32	3.97	0.1563	43.0	75.0	3.97
A100N22	N22	3.99	0.1570	43.0	75.0	3.99
A1004.0	–	4.00	0.1575	43.0	75.0	4.00
A100N21	N21	4.04	0.1590	43.0	75.0	4.04
A100N20	N20	4.09	0.1610	43.0	75.0	4.09
A1004.1	–	4.10	0.1614	43.0	75.0	4.10
A1004.2	–	4.20	0.1654	43.0	75.0	4.20
A100N19	N19	4.22	0.1660	43.0	75.0	4.22
A1004.25	–	4.25	0.1673	43.0	75.0	4.25
A1004.3	–	4.30	0.1693	47.0	80.0	4.30
A100N18	N18	4.31	0.1695	47.0	80.0	4.31
A10011/64	11/64	4.37	0.1719	47.0	80.0	4.37
A100N17	N17	4.39	0.1730	47.0	80.0	4.39
A1004.4	–	4.40	0.1732	47.0	80.0	4.40
A1004.5	–	4.50	0.1772	47.0	80.0	4.50
A100N16	N16	4.50	0.1770	47.0	80.0	4.50
A100N15	N15	4.57	0.1800	47.0	80.0	4.57
A1004.6	–	4.60	0.1811	47.0	80.0	4.60



Product	DC	DC	DC	LCF	OAL	DCON MS
	(inch)	(mm)	(inch)	(mm)	(mm)	(mm)
A100N14	N14	4.62	0.1820	47.0	80.0	4.62
A1004.7	–	4.70	0.1850	47.0	80.0	4.70
A100N13	N13	4.70	0.1850	47.0	80.0	4.70
A1004.75	–	4.75	0.1870	47.0	80.0	4.75
A1003/16	3/16	4.76	0.1875	52.0	86.0	4.76
A1004.8	–	4.80	0.1890	52.0	86.0	4.80
A100N12	N12	4.80	0.1890	52.0	86.0	4.80
A100N11	N11	4.85	0.1910	52.0	86.0	4.85
A1004.9	–	4.90	0.1929	52.0	86.0	4.90
A100N10	N10	4.92	0.1935	52.0	86.0	4.92
A100N9	N9	4.98	0.1960	52.0	86.0	4.98
A1005.0	–	5.00	0.1969	52.0	86.0	5.00
A100N8	N8	5.06	0.1990	52.0	86.0	5.06
A1005.1	–	5.10	0.2008	52.0	86.0	5.10
A100N7	N7	5.11	0.2010	52.0	86.0	5.11
A10013/64	13/64	5.16	0.2031	52.0	86.0	5.16
A100N6	N6	5.18	0.2040	52.0	86.0	5.18
A1005.2	–	5.20	0.2047	52.0	86.0	5.20
A100N5	N5	5.22	0.2055	52.0	86.0	5.22
A1005.25	–	5.25	0.2067	52.0	86.0	5.25
A1005.3	–	5.30	0.2087	52.0	86.0	5.30
A100N4	N4	5.31	0.2090	57.0	93.0	5.31
A1005.4	–	5.40	0.2126	57.0	93.0	5.40
A100N3	N3	5.41	0.2130	57.0	93.0	5.41
A1005.5	–	5.50	0.2165	57.0	93.0	5.50
A1007/32	7/32	5.56	0.2188	57.0	93.0	5.56
A1005.6	–	5.60	0.2205	57.0	93.0	5.60
A100N2	N2	5.61	0.2210	57.0	93.0	5.61
A1005.7	–	5.70	0.2244	57.0	93.0	5.70
A1005.75	–	5.75	0.2264	57.0	93.0	5.75
A100N1	1	5.79	0.2280	57.0	93.0	5.79
A1005.8	–	5.80	0.2283	57.0	93.0	5.80
A1005.9	–	5.90	0.2323	57.0	93.0	5.90
A100A	A	5.94	0.2340	57.0	93.0	5.94
A10015/64	15/64	5.95	0.2344	57.0	93.0	5.95
A1006.0	–	6.00	0.2362	57.0	93.0	6.00
A100B	B	6.03	0.2380	63.0	101.0	6.03
A1006.1	–	6.10	0.2402	63.0	101.0	6.10
A100C	C	6.15	0.2420	63.0	101.0	6.15
A1006.2	–	6.20	0.2441	63.0	101.0	6.20
A1006.25	–	6.25	0.2461	63.0	101.0	6.25
A100D	D	6.25	0.2460	63.0	101.0	6.25
A1006.3	–	6.30	0.2480	63.0	101.0	6.30
A1001/4	1/4	6.35	0.2500	63.0	101.0	6.35
A100E	E	6.35	0.2500	63.0	101.0	6.35
A1006.4	–	6.40	0.2520	63.0	101.0	6.40
A1006.5	–	6.50	0.2559	63.0	101.0	6.50
A100F	F	6.53	0.2570	63.0	101.0	6.53
A1006.6	–	6.60	0.2598	63.0	101.0	6.60
A100G	G	6.63	0.2610	63.0	101.0	6.63
A1006.7	–	6.70	0.2638	63.0	101.0	6.70
A10017/64	17/64	6.75	0.2656	69.0	109.0	6.75
A1006.75	–	6.75	0.2657	69.0	109.0	6.75
A100H	H	6.76	0.2660	69.0	109.0	6.76
A1006.8	–	6.80	0.2677	69.0	109.0	6.80
A1006.9	–	6.90	0.2717	69.0	109.0	6.90
A100I	I	6.91	0.2720	69.0	109.0	6.91
A1007.0	–	7.00	0.2756	69.0	109.0	7.00
A100J	J	7.04	0.2770	69.0	109.0	7.04
A1007.1	–	7.10	0.2795	69.0	109.0	7.10
A1009/32	9/32	7.14	0.2813	69.0	109.0	7.14
A1007.2	–	7.20	0.2835	69.0	109.0	7.20

Product	DC	DC	DC	LCF	OAL	DCON MS
	(inch)	(mm)	(inch)	(mm)	(mm)	(mm)
A1007.25	–	7.25	0.2854	69.0	109.0	7.25
A1007.3	–	7.30	0.2874	69.0	109.0	7.30
A100L	L	7.37	0.2900	69.0	109.0	7.37
A1007.4	–	7.40	0.2913	69.0	109.0	7.40
A1007.5	–	7.50	0.2953	69.0	109.0	7.50
A10019/64	19/64	7.54	0.2969	75.0	117.0	7.54
A1007.6	–	7.60	0.2992	75.0	117.0	7.60
A100N	N	7.67	0.3020	75.0	117.0	7.67
A1007.7	–	7.70	0.3031	75.0	117.0	7.70
A1007.75	–	7.75	0.3051	75.0	117.0	7.75
A1007.8	–	7.80	0.3071	75.0	117.0	7.80
A1007.9	–	7.90	0.3110	75.0	117.0	7.90
A1005/16	5/16	7.94	0.3125	75.0	117.0	7.94
A1008.0	–	8.00	0.3150	75.0	117.0	8.00
A1000	0	8.03	0.3160	75.0	117.0	8.03
A1008.1	–	8.10	0.3189	75.0	117.0	8.10
A1008.2	–	8.20	0.3228	75.0	117.0	8.20
A1008.25	–	8.25	0.3248	75.0	117.0	8.25
A1008.3	–	8.30	0.3268	75.0	117.0	8.30
A10021/64	21/64	8.33	0.3281	75.0	117.0	8.33
A1008.4	–	8.40	0.3307	75.0	117.0	8.40
A100Q	Q	8.43	0.3320	75.0	117.0	8.43
A1008.5	–	8.50	0.3346	75.0	117.0	8.50
A1008.6	–	8.60	0.3386	81.0	125.0	8.60
A1008.7	–	8.70	0.3425	81.0	125.0	8.70
A10011/32	11/32	8.73	0.3438	81.0	125.0	8.73
A1008.75	–	8.75	0.3445	81.0	125.0	8.75
A1008.8	–	8.80	0.3465	81.0	125.0	8.80
A1008.9	–	8.90	0.3504	81.0	125.0	8.90
A1009.0	–	9.00	0.3543	81.0	125.0	9.00
A1009.1	–	9.10	0.3583	81.0	125.0	9.10
A10023/64	23/64	9.13	0.3594	81.0	125.0	9.13
A1009.2	–	9.20	0.3622	81.0	125.0	9.20
A1009.25	–	9.25	0.3642	81.0	125.0	9.25
A1009.3	–	9.30	0.3661	81.0	125.0	9.30
A100U	U	9.35	0.3680	81.0	125.0	9.35
A1009.4	–	9.40	0.3701	81.0	125.0	9.40
A1009.5	–	9.50	0.3740	81.0	125.0	9.50
A1003/8	3/8	9.52	0.3750	87.0	133.0	9.52
A1009.6	–	9.60	0.3780	87.0	133.0	9.60
A1009.7	–	9.70	0.3819	87.0	133.0	9.70
A1009.75	–	9.75	0.3839	87.0	133.0	9.75
A1009.8	–	9.80	0.3858	87.0	133.0	9.80
A1009.9	–	9.90	0.3898	87.0	133.0	9.90
A10025/64	25/64	9.92	0.3906	87.0	133.0	9.92
A10010.0	–	10.00	0.3937	87.0	133.0	10.00
A10010.1	–	10.10	0.3976	87.0	133.0	10.10
A10010.2	–	10.20	0.4016	87.0	133.0	10.20
A10010.25	–	10.25	0.4035	87.0	133.0	10.25
A10010.3	–	10.30	0.4055	87.0	133.0	10.30
A10013/32	13/32	10.32	0.4063	87.0	133.0	10.32
A10010.4	–	10.40	0.4094	87.0	133.0	10.40
A10010.5	–	10.50	0.4134	87.0	133.0	10.50
A10010.6	–	10.60	0.4173	87.0	133.0	10.60
A10010.7	–	10.70	0.4213	94.0	142.0	10.70
A10027/64	27/64	10.72	0.4219	94.0	142.0	10.72
A10010.75	–	10.75	0.4232	94.0	142.0	10.75
A10010.8	–	10.80	0.4252	94.0	142.0	10.80
A10010.9	–	10.90	0.4291	94.0	142.0	10.90
A10011.0	–	11.00	0.4331	94.0	142.0	11.00
A10011.1	–	11.10	0.4370	94.0	142.0	11.10
A1007/16	7/16	11.11	0.4375	94.0	142.0	11.11



Product	DC	DC	DC	LCF	OAL	DCON MS
	(inch)	(mm)	(inch)	(mm)	(mm)	(mm)
A10011.2	–	11.20	0.4409	94.0	142.0	11.20
A10011.25	–	11.25	0.4429	94.0	142.0	11.25
A10011.3	–	11.30	0.4449	94.0	142.0	11.30
A10011.4	–	11.40	0.4488	94.0	142.0	11.40
A10011.5	–	11.50	0.4528	94.0	142.0	11.50
A10029/64	29/64	11.51	0.4531	94.0	142.0	11.51
A10011.6	–	11.60	0.4567	94.0	142.0	11.60
A10011.7	–	11.70	0.4606	94.0	142.0	11.70
A10011.75	–	11.75	0.4626	94.0	142.0	11.75
A10011.8	–	11.80	0.4646	94.0	142.0	11.80
A10011.9	–	11.90	0.4685	101.0	151.0	11.90
A10015/32	15/32	11.91	0.4688	101.0	151.0	11.91
A10012.0	–	12.00	0.4724	101.0	151.0	12.00
A10012.1	–	12.10	0.4764	101.0	151.0	12.10
A10012.2	–	12.20	0.4803	101.0	151.0	12.20
A10012.25	–	12.25	0.4823	101.0	151.0	12.25
A10012.3	–	12.30	0.4843	101.0	151.0	12.30
A10031/64	31/64	12.30	0.4844	101.0	151.0	12.30
A10012.4	–	12.40	0.4882	101.0	151.0	12.40
A10012.5	–	12.50	0.4921	101.0	151.0	12.50
A10012.6	–	12.60	0.4961	101.0	151.0	12.60
A10012.7	–	12.70	0.5000	101.0	151.0	12.70
A1001/2	1/2	12.70	0.5000	101.0	151.0	12.70
A10012.75	–	12.75	0.5020	101.0	151.0	12.75
A10012.8	–	12.80	0.5039	101.0	151.0	12.80
A10012.9	–	12.90	0.5079	101.0	151.0	12.90
A10013.0	–	13.00	0.5118	101.0	151.0	13.00
A10033/64	33/64	13.10	0.5156	101.0	151.0	13.10
A10013.1	–	13.10	0.5157	101.0	151.0	13.10
A10013.2	–	13.20	0.5197	101.0	151.0	13.20
A10013.25	–	13.25	0.5217	108.0	160.0	13.25
A10013.3	–	13.30	0.5236	108.0	160.0	13.30
A10013.4	–	13.40	0.5276	108.0	160.0	13.40

Product	DC	DC	DC	LCF	OAL	DCON MS
	(inch)	(mm)	(inch)	(mm)	(mm)	(mm)
A10017/32	17/32	13.49	0.5313	108.0	160.0	13.49
A10013.5	–	13.50	0.5315	108.0	160.0	13.50
A10013.6	–	13.60	0.5354	108.0	160.0	13.60
A10013.7	–	13.70	0.5394	108.0	160.0	13.70
A10013.75	–	13.75	0.5413	108.0	160.0	13.75
A10013.8	–	13.80	0.5433	108.0	160.0	13.80
A10035/64	35/64	13.89	0.5469	108.0	160.0	13.89
A10013.9	–	13.90	0.5472	108.0	160.0	13.90
A10014.0	–	14.00	0.5512	108.0	160.0	14.00
A10014.25	–	14.25	0.5610	114.0	169.0	14.25
A1009/16	9/16	14.29	0.5625	114.0	169.0	14.29
A10014.5	–	14.50	0.5709	114.0	169.0	14.50
A10037/64	37/64	14.68	0.5781	114.0	169.0	14.68
A10014.75	–	14.75	0.5807	114.0	169.0	14.75
A10015.0	–	15.00	0.5906	114.0	169.0	15.00
A10019/32	19/32	15.08	0.5938	120.0	178.0	15.08
A10015.25	–	15.25	0.6004	120.0	178.0	15.25
A10015.5	–	15.50	0.6102	120.0	178.0	15.50
A10015.75	–	15.75	0.6201	120.0	178.0	15.75
A1005/8	5/8	15.88	0.6250	120.0	178.0	15.88
A10016.0	–	16.00	0.6299	120.0	178.0	16.00
A10041/64	41/64	16.27	0.6406	125.0	184.0	16.27
A10016.5	–	16.50	0.6496	125.0	184.0	16.50
A10021/32	21/32	16.67	0.6563	125.0	184.0	16.67
A10017.0	–	17.00	0.6693	125.0	184.0	17.00
A10011/16	11/16	17.46	0.6875	130.0	191.0	17.46
A10017.5	–	17.50	0.6890	130.0	191.0	17.50
A10018.0	–	18.00	0.7087	130.0	191.0	18.00
A10018.5	–	18.50	0.7283	135.0	198.0	18.50
A10019.0	–	19.00	0.7480	135.0	198.0	19.00
A10019.5	–	19.50	0.7677	140.0	205.0	19.50
A10020.0	–	20.00	0.7874	140.0	205.0	20.00

A101



Broca HSS Serie Corta, a Izquierda, Acabado Templado al Vapor

Broca versátil a izquierda con acabado templado al vapor para taladrado manual y en máquina. La punta convencional a 118° proporciona resistencia y facilita el reafilado, haciendola mas rentable. El acabado templado al vapor retiene el fluido de corte y evita la soldadura de la viruta a la herramienta. Apta para taladrar muchos materiales.

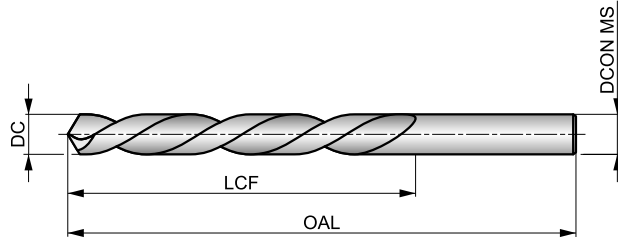

HSS	DIN 338	4×D
118°	ST	
λ 20-35°	L	DC h8

Grupo de Material de la pieza adecuado y condiciones de velocidad de corte iniciales (m/min) y código de avance alfabético. Tablas con avance por revolución a partir de la pag.274.

P1.1 ■ 33 H	P1.2 ■ 37 H	P1.3 ■ 38 H	P2.1 ■ 28 H	P2.2 ■ 25 F	P2.3 ■ 22 E	P3.1 ■ 19 F	P3.2 ■ 15 F	P3.3 ■ 13 E	P4.1 ■ 11 F	P4.2 ■ 10 E	P4.3 ■ 8 D	M1.1 ■ 21 E	M1.2 ■ 17 E
M2.1 ■ 18 E	M2.2 ■ 15 E	M3.1 ■ 9 G	M3.2 ■ 8 G	M3.3 ■ 7 G	M4.1 ■ 9 C	K1.1 ■ 30 H	K1.2 ■ 22 F	K1.3 ■ 17 F	K2.1 ■ 25 E	K2.2 ■ 20 E	K2.3 ■ 16 E	K3.1 ■ 22 E	K3.2 ■ 17 E
K3.3 ■ 13 E	K4.1 ■ 20 E	K4.2 ■ 15 E	K4.3 ■ 11 E	K4.4 ■ 10 E	K4.5 ■ 8 E	K5.1 ■ 23 E	K5.2 ■ 17 E	K5.3 ■ 13 E	N1.1 ■ 33 J	N1.2 ■ 25 J	N1.3 ■ 17 I	N2.1 ■ 42 H	N2.2 ■ 37 H
N2.3 ■ 27 H	N3.1 ■ 59 H	N3.2 ■ 35 I	N3.3 ■ 18 G	N4.1 ■ 30 J	N4.2 ■ 28 H	N4.3 ■ 14 F	S1.1 ■ 23 E	S1.2 ■ 12 D	S1.3 ■ 6 B	S2.1 ■ 8 E	S2.2 ■ 4 A	S3.1 ■ 6 E	S3.2 ■ 3 A
S4.1 ■ 5 E	S4.2 ■ 2 A												

DC <= 3mm Brillante

Product	DC (mm)	DC (inch)	LCF (mm)	OAL (mm)	DCON MS (mm)
A1011.0	1.00	0.0394	12.0	34.0	1.00
A1011.1	1.10	0.0433	14.0	36.0	1.10
A1011.2	1.20	0.0472	16.0	38.0	1.20
A1011.25	1.25	0.0492	16.0	38.0	1.25
A1011.3	1.30	0.0512	16.0	38.0	1.30
A1011.4	1.40	0.0551	18.0	40.0	1.40
A1011.5	1.50	0.0591	18.0	40.0	1.50
A1011.6	1.60	0.0630	20.0	43.0	1.60
A1011.7	1.70	0.0669	20.0	43.0	1.70
A1011.8	1.80	0.0709	22.0	46.0	1.80
A1011.9	1.90	0.0748	22.0	46.0	1.90
A1012.0	2.00	0.0787	24.0	49.0	2.00
A1012.1	2.10	0.0827	24.0	49.0	2.10
A1012.2	2.20	0.0866	27.0	53.0	2.20
A1012.4	2.40	0.0945	30.0	57.0	2.40
A1012.5	2.50	0.0984	30.0	57.0	2.50
A1012.6	2.60	0.1024	30.0	57.0	2.60
A1012.7	2.70	0.1063	33.0	61.0	2.70
A1012.8	2.80	0.1102	33.0	61.0	2.80
A1012.9	2.90	0.1142	33.0	61.0	2.90
A1013.0	3.00	0.1181	33.0	61.0	3.00
A1013.2	3.20	0.1260	36.0	65.0	3.20

Product	DC (mm)	DC (inch)	LCF (mm)	OAL (mm)	DCON MS (mm)
A1013.3	3.30	0.1299	36.0	65.0	3.30
A1013.5	3.50	0.1378	39.0	70.0	3.50
A1013.8	3.80	0.1496	43.0	75.0	3.80
A1014.0	4.00	0.1575	43.0	75.0	4.00
A1014.2	4.20	0.1654	43.0	75.0	4.20
A1014.5	4.50	0.1772	47.0	80.0	4.50
A1014.8	4.80	0.1890	52.0	86.0	4.80
A1015.0	5.00	0.1969	52.0	86.0	5.00
A1015.1	5.10	0.2008	52.0	86.0	5.10
A1015.2	5.20	0.2047	52.0	86.0	5.20
A1015.5	5.50	0.2165	57.0	93.0	5.50
A1016.0	6.00	0.2362	57.0	93.0	6.00
A1016.5	6.50	0.2559	63.0	101.0	6.50
A1017.0	7.00	0.2756	69.0	109.0	7.00
A1017.5	7.50	0.2953	69.0	109.0	7.50
A1018.0	8.00	0.3150	75.0	117.0	8.00
A1018.5	8.50	0.3346	75.0	117.0	8.50
A1019.0	9.00	0.3543	81.0	125.0	9.00
A10110.0	10.00	0.3937	87.0	133.0	10.00
A10111.0	11.00	0.4331	94.0	142.0	11.00
A10112.0	12.00	0.4724	101.0	151.0	12.00

A170



Broca HSS de Mango Rebajado, con Acabado Templado al Vapor

El mango cilíndrico de 1/2 pulgada permite a esta broca, incluso en diámetros grandes, ser montada en una máquina manual. La punta a 118° facilita el afilado. La superficie templada al vapor actúa reteniendo el fluido de corte y evitando que la viruta se suelde a la herramienta.

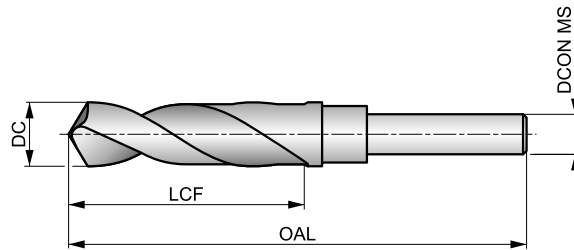

HSS	DORMER	4xD
118°	ST	
λ 20-35°	R	DC h8

Grupo de Material de la pieza adecuado y condiciones de velocidad de corte iniciales (m/min) y código de avance alfabético. Tablas con avance por revolución a partir de la pag.274.

P1.1 ■ 33 H	P1.2 ■ 37 H	P1.3 ■ 38 H	P2.1 ■ 28 H	P2.2 ■ 25 F	P2.3 ■ 22 D	P3.1 ■ 19 E	P3.2 ■ 15 E	P3.3 ■ 13 D	P4.1 ■ 11 E	P4.2 ■ 10 D	P4.3 ■ 8 C	M1.1 ■ 21 D	M1.2 ■ 17 D
M2.1 ■ 18 D	M2.2 ■ 15 D	M3.1 ■ 8 F	M3.2 ■ 7 F	M3.3 ■ 6 F	M4.1 ■ 7 B	K1.1 ■ 27 H	K1.2 ■ 20 E	K1.3 ■ 15 E	K2.1 ■ 23 D	K2.2 ■ 19 D	K2.3 ■ 15 D	K3.1 ■ 21 D	K3.2 ■ 16 D
K3.3 ■ 13 D	K4.1 ■ 19 D	K4.2 ■ 14 D	K4.3 ■ 11 D	K4.4 ■ 9 D	K4.5 ■ 8 D	K5.1 ■ 22 D	K5.2 ■ 16 D	K5.3 ■ 13 D	N1.1 ■ 33 I	N1.2 ■ 25 I	N1.3 ■ 17 H	N2.1 ■ 42 G	N2.2 ■ 37 G
N2.3 ■ 27 G	N3.1 ■ 56 G	N3.2 ■ 33 H	N3.3 ■ 17 F	N4.1 ■ 30 I	N4.2 ■ 28 G	N4.3 ■ 14 E	S1.1 ■ 17 E	S1.2 ■ 9 C	S1.3 ■ 5 A	S2.1 ■ 5 D	S2.2 ■ 4 A	S3.1 ■ 4 D	S3.2 ■ 3 A
S4.1 ■ 3 D	S4.2 ■ 2 A												

Product	DC	DC	DC	LCF	OAL	LCF	OAL	DCON MS
	(inch)	(mm)	(inch)	(inch)	(inch)	(mm)	(mm)	(mm)
A17013.0	-	13.00	0.5118	-	-	83.0	156.0	12.70
A17033/64	33/64	13.10	0.5156	3.1/8	6"	79.4	152.4	12.70
A17017/32	17/32	13.49	0.5313	3.1/8	6"	79.4	152.4	12.70
A17013.5	-	13.50	0.5315	-	-	83.0	156.0	12.70
A17035/64	35/64	13.89	0.5469	3.1/8	6"	79.4	152.4	12.70
A17014.0	-	14.00	0.5512	-	-	83.0	156.0	12.70
A1709/16	9/16	14.29	0.5625	3.1/8	6"	79.4	152.4	12.70
A17014.5	-	14.50	0.5709	-	-	83.0	156.0	12.70
A17037/64	37/64	14.68	0.5781	3.1/8	6"	79.4	152.4	12.70
A17015.0	-	15.00	0.5906	-	-	83.0	156.0	12.70
A17019/32	19/32	15.08	0.5938	3.1/8	6"	79.4	152.4	12.70
A17039/64	39/64	15.48	0.6094	3.1/8	6"	79.4	152.4	12.70
A17015.5	-	15.50	0.6102	-	-	83.0	156.0	12.70
A1705/8	5/8	15.88	0.6250	3.1/8	6"	79.4	152.4	12.70
A17016.0	-	16.00	0.6299	-	-	84.0	157.0	12.70
A17041/64	41/64	16.27	0.6406	3.1/8	6"	79.4	152.4	12.70
A17016.5	-	16.50	0.6496	-	-	84.0	157.0	12.70
A17021/32	21/32	16.67	0.6563	3.1/8	6"	79.4	152.4	12.70
A17017.0	-	17.00	0.6693	-	-	84.0	157.0	12.70
A17043/64	43/64	17.07	0.6719	3.1/8	6"	79.4	152.4	12.70
A17011/16	11/16	17.46	0.6875	3.1/8	6"	79.4	152.4	12.70
A17017.5	-	17.50	0.6890	-	-	84.0	157.0	12.70
A17045/64	45/64	17.86	0.7031	3.1/8	6"	79.4	152.4	12.70
A17018.0	-	18.00	0.7087	-	-	84.0	157.0	12.70



Product	DC	DC	DC	LCF	OAL	LCF	OAL	DCON MS
	(inch)	(mm)	(inch)	(inch)	(inch)	(mm)	(mm)	(mm)
A17023/32	23/32	18.26	0.7188	3.1/8	6"	79.4	152.4	12.70
A17018.5	–	18.50	0.7283	–	–	84.0	157.0	12.70
A17047/64	47/64	18.65	0.7344	3.1/8	6"	79.4	152.4	12.70
A17019.0	–	19.00	0.7480	–	–	84.0	157.0	12.70
A1703/4	3/4	19.05	0.7500	3.1/8	6"	79.4	152.4	12.70
A17049/64	49/64	19.45	0.7656	3"	6"	76.2	152.4	12.70
A17019.5	–	19.50	0.7677	–	–	81.0	158.0	12.70
A17025/32	25/32	19.84	0.7813	3"	6"	76.2	152.4	12.70
A17020.0	–	20.00	0.7874	–	–	81.0	158.0	12.70
A17051/64	51/64	20.24	0.7969	3"	6"	76.2	152.4	12.70
A17013/16	13/16	20.64	0.8125	3"	6"	76.2	152.4	12.70
A17021.0	–	21.00	0.8268	–	–	82.0	158.0	12.70
A17053/64	53/64	21.03	0.8281	3"	6"	76.2	152.4	12.70
A17027/32	27/32	21.43	0.8437	3"	6"	76.2	152.4	12.70
A17055/64	55/64	21.83	0.8594	3"	6"	76.2	152.4	12.70
A17022.0	–	22.00	0.8661	–	–	82.0	158.0	12.70
A1707/8	7/8	22.22	0.8750	3"	6"	76.2	152.4	12.70
A17023.0	–	23.00	0.9055	–	–	82.0	158.0	12.70
A17029/32	29/32	23.02	0.9063	3"	6"	76.2	152.4	12.70
A17059/64	59/64	23.42	0.9219	3"	6"	76.2	152.4	12.70
A17015/16	15/16	23.81	0.9375	3"	6"	76.2	152.4	12.70
A17024.0	–	24.00	0.9449	–	–	83.0	159.0	12.70
A17031/32	31/32	24.61	0.9688	3"	6"	76.2	152.4	12.70
A17025.0	–	25.00	0.9843	–	–	83.0	159.0	12.70
A1701	1"	25.40	1.0000	3"	6"	76.2	152.4	12.70
A1701.1/32	1.1/32	26.19	1.0313	3"	6"	76.2	152.4	12.70
A1701.1/16	1.1/16	26.99	1.0625	3"	6"	76.2	152.4	12.70
A1701.1/8	1.1/8	28.58	1.1250	3"	6"	76.2	152.4	12.70
A1701.3/16	1.3/16	30.16	1.1875	3"	6"	76.2	152.4	12.70
A1701.1/4	1.1/4	31.75	1.2500	3"	6"	76.2	152.4	12.70

A130



Broca HSS, Mango Cónico, Acabado Templado al Vapor

Broca versátil con diámetros más grandes: hasta 50,80 mm (2 pulgadas). El mango cónico proporciona un mejor agarre al sujetarlo en la máquina. La punta convencional a 118° proporciona resistencia y facilita el reafilado. El acabado templado al vapor retiene el fluido de corte y evita la soldadura de la viruta a la herramienta. Apta para taladrar muchos materiales.

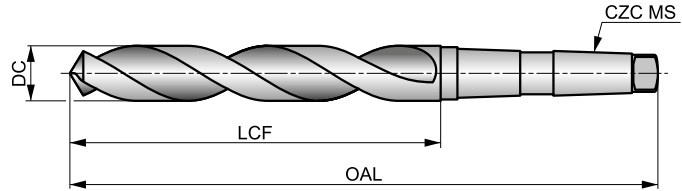

HSS	DIN 345	4xD
118°	ST	
λ 20-35°	R	DC h8

Grupo de Material de la pieza adecuado y condiciones de velocidad de corte iniciales (m/min) y código de avance alfabético. Tablas con avance por revolución a partir de la pag.274.

P1.1 ■ 33 I	P1.2 ■ 37 I	P1.3 ■ 38 I	P2.1 ■ 28 I	P2.2 ■ 25 F	P2.3 ■ 22 E	P3.1 ■ 18 F	P3.2 ■ 14 F	P3.3 ■ 12 E	P4.1 ■ 11 F	P4.2 ■ 9 E	P4.3 ■ 7 D	M1.1 ■ 21 E	M1.2 ■ 17 E
M2.1 ■ 18 E	M2.2 ■ 15 E	M3.1 ■ 10 G	M3.2 ■ 9 G	M3.3 ■ 8 G	M4.1 ■ 10 C	K1.1 ■ 30 I	K1.2 ■ 22 E	K1.3 ■ 17 E	K2.1 ■ 25 E	K2.2 ■ 20 E	K2.3 ■ 16 E	K3.1 ■ 22 E	K3.2 ■ 17 E
K3.3 ■ 13 E	K4.1 ■ 20 E	K4.2 ■ 15 E	K4.3 ■ 11 E	K4.4 ■ 10 E	K4.5 ■ 8 E	K5.1 ■ 23 E	K5.2 ■ 17 E	K5.3 ■ 13 E	N1.1 ■ 26 J	N1.2 ■ 20 J	N1.3 ■ 13 I	N2.1 ■ 43 H	N2.2 ■ 39 H
N2.3 ■ 28 H	N3.1 ■ 59 H	N3.2 ■ 35 I	N3.3 ■ 18 F	N4.1 ■ 30 K	N4.2 ■ 28 J	N4.3 ■ 14 H	S1.1 ■ 23 F	S1.2 ■ 13 D	S1.3 ■ 7 B	S2.1 ■ 9 E	S2.2 ■ 6 A	S3.1 ■ 7 E	S3.2 ■ 4 A
S4.1 ■ 5 E	S4.2 ■ 3 A												

DC > 14mm Punta Adelgazada

Product	DC (inch)	DC (mm)	DC (inch)	LCF (mm)	OAL (mm)	CZC MS
A1303.0	-	3.00	0.1181	33.0	114.0	MK 1
A1301/8	1/8	3.18	0.1250	36.0	117.0	MK 1
A1303.3	-	3.30	0.1299	36.0	117.0	MK 1
A1303.5	-	3.50	0.1378	39.0	120.0	MK 1
A1304.0	-	4.00	0.1575	43.0	124.0	MK 1
A1304.2	-	4.20	0.1654	43.0	124.0	MK 1
A1304.25	-	4.25	0.1673	43.0	124.0	MK 1
A1304.5	-	4.50	0.1772	47.0	128.0	MK 1
A1303/16	3/16	4.76	0.1875	52.0	133.0	MK 1
A1305.0	-	5.00	0.1969	52.0	133.0	MK 1
A1305.1	-	5.10	0.2008	52.0	133.0	MK 1
A13013/64	13/64	5.16	0.2031	52.0	133.0	MK 1
A1305.2	-	5.20	0.2047	52.0	133.0	MK 1
A1305.5	-	5.50	0.2165	57.0	138.0	MK 1
A1306.0	-	6.00	0.2362	57.0	138.0	MK 1
A1301/4	1/4	6.35	0.2500	63.0	144.0	MK 1
A1306.5	-	6.50	0.2559	63.0	144.0	MK 1
A1306.7	-	6.70	0.2638	63.0	144.0	MK 1
A13017/64	17/64	6.75	0.2656	69.0	150.0	MK 1
A1306.75	-	6.75	0.2657	69.0	150.0	MK 1
A1306.8	-	6.80	0.2677	69.0	150.0	MK 1
A1307.0	-	7.00	0.2756	69.0	150.0	MK 1
A1309/32	9/32	7.14	0.2813	69.0	150.0	MK 1



Product	DC	DC	DC	LCF	OAL	CZC MS
	(inch)	(mm)	(inch)	(mm)	(mm)	
A1307.5	–	7.50	0.2953	69.0	150.0	MK 1
A1305/16	5/16	7.94	0.3125	75.0	156.0	MK 1
A1308.0	–	8.00	0.3150	75.0	156.0	MK 1
A1308.2	–	8.20	0.3228	75.0	156.0	MK 1
A1308.5	–	8.50	0.3346	75.0	156.0	MK 1
A1308.6	–	8.60	0.3386	81.0	162.0	MK 1
A1308.7	–	8.70	0.3425	81.0	162.0	MK 1
A13011/32	11/32	8.73	0.3438	81.0	162.0	MK 1
A1308.75	–	8.75	0.3445	81.0	162.0	MK 1
A1309.0	–	9.00	0.3543	81.0	162.0	MK 1
A1309.5	–	9.50	0.3740	81.0	162.0	MK 1
A1303/8	3/8	9.52	0.3750	87.0	168.0	MK 1
A13010.0	–	10.00	0.3937	87.0	168.0	MK 1
A13010.2	–	10.20	0.4016	87.0	168.0	MK 1
A13010.25	–	10.25	0.4035	87.0	168.0	MK 1
A13010.3	–	10.30	0.4055	87.0	168.0	MK 1
A13013/32	13/32	10.32	0.4063	87.0	168.0	MK 1
A13010.5	–	10.50	0.4134	87.0	168.0	MK 1
A13027/64	27/64	10.72	0.4219	94.0	175.0	MK 1
A13010.75	–	10.75	0.4232	94.0	175.0	MK 1
A13010.8	–	10.80	0.4252	94.0	175.0	MK 1
A13011.0	–	11.00	0.4331	94.0	175.0	MK 1
A1307/16	7/16	11.11	0.4375	94.0	175.0	MK 1
A13011.2	–	11.20	0.4409	94.0	175.0	MK 1
A13011.5	–	11.50	0.4528	94.0	175.0	MK 1
A13011.75	–	11.75	0.4626	94.0	175.0	MK 1
A13011.8	–	11.80	0.4646	94.0	175.0	MK 1
A13012.0	–	12.00	0.4724	101.0	182.0	MK 1
A13012.2	–	12.20	0.4803	101.0	182.0	MK 1
A13012.25	–	12.25	0.4823	101.0	182.0	MK 1
A13031/64	31/64	12.30	0.4844	101.0	182.0	MK 1
A13012.5	–	12.50	0.4921	101.0	182.0	MK 1
A13012.7	–	12.70	0.5000	101.0	182.0	MK 1
A1301/2	1/2	12.70	0.5000	101.0	182.0	MK 1
A13012.75	–	12.75	0.5020	101.0	182.0	MK 1
A13012.8	–	12.80	0.5039	101.0	182.0	MK 1
A13013.0	–	13.00	0.5118	101.0	182.0	MK 1
A13033/64	33/64	13.10	0.5156	101.0	182.0	MK 1
A13013.2	–	13.20	0.5197	101.0	182.0	MK 1
A13013.25	–	13.25	0.5217	108.0	189.0	MK 1
A13017/32	17/32	13.49	0.5313	108.0	189.0	MK 1
A13013.5	–	13.50	0.5315	108.0	189.0	MK 1
A13013.75	–	13.75	0.5413	108.0	189.0	MK 1
A13013.8	–	13.80	0.5433	108.0	189.0	MK 1
A13013.9	–	13.90	0.5472	108.0	189.0	MK 1
A13014.0	–	14.00	0.5512	108.0	189.0	MK 1
A13014.1	–	14.10	0.5551	114.0	212.0	MK 2
A13014.2	–	14.20	0.5591	114.0	212.0	MK 2
A13014.25	–	14.25	0.5610	114.0	212.0	MK 2
A1309/16	9/16	14.29	0.5625	114.0	212.0	MK 2
A13014.3	–	14.30	0.5630	114.0	212.0	MK 2
A13014.5	–	14.50	0.5709	114.0	212.0	MK 2
A13037/64	37/64	14.68	0.5781	114.0	212.0	MK 2
A13014.75	–	14.75	0.5807	114.0	212.0	MK 2
A13014.8	–	14.80	0.5827	114.0	212.0	MK 2
A13014.9	–	14.90	0.5866	114.0	212.0	MK 2
A13015.0	–	15.00	0.5906	114.0	212.0	MK 2
A13015.1	–	15.10	0.5945	120.0	218.0	MK 2
A13015.2	–	15.20	0.5984	120.0	218.0	MK 2
A13015.25	–	15.25	0.6004	120.0	218.0	MK 2
A13039/64	39/64	15.48	0.6094	120.0	218.0	MK 2
A13015.5	–	15.50	0.6102	120.0	218.0	MK 2

Product	DC	DC	DC	LCF	OAL	CZC MS
	(inch)	(mm)	(inch)	(mm)	(mm)	
A13015.7	–	15.70	0.6181	120.0	218.0	MK 2
A13015.75	–	15.75	0.6201	120.0	218.0	MK 2
A13015.8	–	15.80	0.6220	120.0	218.0	MK 2
A1305/8	5/8	15.88	0.6250	120.0	218.0	MK 2
A13015.9	–	15.90	0.6260	120.0	218.0	MK 2
A13016.0	–	16.00	0.6299	120.0	218.0	MK 2
A13016.1	–	16.10	0.6339	125.0	223.0	MK 2
A13016.2	–	16.20	0.6378	125.0	223.0	MK 2
A13016.25	–	16.25	0.6398	125.0	223.0	MK 2
A13041/64	41/64	16.27	0.6406	125.0	223.0	MK 2
A13016.5	–	16.50	0.6496	125.0	223.0	MK 2
A13021/32	21/32	16.67	0.6563	125.0	223.0	MK 2
A13016.75	–	16.75	0.6594	125.0	223.0	MK 2
A13017.0	–	17.00	0.6693	125.0	223.0	MK 2
A13043/64	43/64	17.07	0.6719	130.0	228.0	MK 2
A13017.25	–	17.25	0.6791	130.0	228.0	MK 2
A13011/16	11/16	17.46	0.6875	130.0	228.0	MK 2
A13017.5	–	17.50	0.6890	130.0	228.0	MK 2
A13017.75	–	17.75	0.6988	130.0	228.0	MK 2
A13045/64	45/64	17.86	0.7031	130.0	228.0	MK 2
A13018.0	–	18.00	0.7087	130.0	228.0	MK 2
A13018.25	–	18.25	0.7185	135.0	233.0	MK 2
A13023/32	23/32	18.26	0.7188	135.0	233.0	MK 2
A13018.5	–	18.50	0.7283	135.0	233.0	MK 2
A13047/64	47/64	18.65	0.7344	135.0	233.0	MK 2
A13018.75	–	18.75	0.7382	135.0	233.0	MK 2
A13019.0	–	19.00	0.7480	135.0	233.0	MK 2
A1303/4	3/4	19.05	0.7500	140.0	238.0	MK 2
A13019.25	–	19.25	0.7579	140.0	238.0	MK 2
A13019.5	–	19.50	0.7677	140.0	238.0	MK 2
A13019.75	–	19.75	0.7776	140.0	238.0	MK 2
A13025/32	25/32	19.84	0.7813	140.0	238.0	MK 2
A13020.0	–	20.00	0.7874	140.0	238.0	MK 2
A13020.25	–	20.25	0.7972	145.0	243.0	MK 2
A13020.5	–	20.50	0.8071	145.0	243.0	MK 2
A13013/16	13/16	20.64	0.8125	145.0	243.0	MK 2
A13020.75	–	20.75	0.8169	145.0	243.0	MK 2
A13021.0	–	21.00	0.8268	145.0	243.0	MK 2
A13021.25	–	21.25	0.8366	150.0	248.0	MK 2
A13021.5	–	21.50	0.8465	150.0	248.0	MK 2
A13021.75	–	21.75	0.8563	150.0	248.0	MK 2
A13022.0	–	22.00	0.8661	150.0	248.0	MK 2
A1307/8	7/8	22.22	0.8750	150.0	248.0	MK 2
A13022.25	–	22.25	0.8760	150.0	248.0	MK 2
A13022.5	–	22.50	0.8858	155.0	253.0	MK 2
A13057/64	57/64	22.62	0.8906	155.0	253.0	MK 2
A13022.75	–	22.75	0.8957	155.0	253.0	MK 2
A13023.0	–	23.00	0.9055	155.0	253.0	MK 2
A13029/32	29/32	23.02	0.9063	155.0	253.0	MK 2
A13023.25	–	23.25	0.9154	155.0	276.0	MK 3
A13023.5	–	23.50	0.9252	155.0	276.0	MK 3
A13023.75	–	23.75	0.9350	160.0	281.0	MK 3
A13015/16	15/16	23.81	0.9375	160.0	281.0	MK 3
A13024.0	–	24.00	0.9449	160.0	281.0	MK 3
A13061/64	61/64	24.21	0.9531	160.0	281.0	MK 3
A13024.5	–	24.50	0.9646	160.0	281.0	MK 3
A13024.75	–	24.75	0.9744	160.0	281.0	MK 3
A13025.0	–	25.00	0.9843	160.0	281.0	MK 3
A13025.25	–	25.25	0.9941	165.0	286.0	MK 3
A1301	1"	25.40	1.0000	165.0	286.0	MK 3
A13025.5	–	25.50	1.0039	165.0	286.0	MK 3
A13025.75	–	25.75	1.0138	165.0	286.0	MK 3

Product	DC	DC	DC	LCF	OAL	CZC MS
	(inch)	(mm)	(inch)	(mm)	(mm)	
A13026.0	–	26.00	1.0236	165.0	286.0	MK 3
A13026.25	–	26.25	1.0335	165.0	286.0	MK 3
A13026.5	–	26.50	1.0433	165.0	286.0	MK 3
A1301.1/16	1.1/16	26.99	1.0625	170.0	291.0	MK 3
A13027.0	–	27.00	1.0630	170.0	291.0	MK 3
A13027.5	–	27.50	1.0827	170.0	291.0	MK 3
A13028.0	–	28.00	1.1024	170.0	291.0	MK 3
A13028.5	–	28.50	1.1220	175.0	296.0	MK 3
A1301.1/8	1.1/8	28.58	1.1250	175.0	296.0	MK 3
A13029.0	–	29.00	1.1417	175.0	296.0	MK 3
A13029.5	–	29.50	1.1614	175.0	296.0	MK 3
A13030.0	–	30.00	1.1811	175.0	296.0	MK 3
A1301.3/16	1.3/16	30.16	1.1875	180.0	301.0	MK 3
A13030.5	–	30.50	1.2008	180.0	301.0	MK 3
A13031.0	–	31.00	1.2205	180.0	301.0	MK 3
A13031.5	–	31.50	1.2402	180.0	301.0	MK 3
A1301.1/4	1.1/4	31.75	1.2500	185.0	306.0	MK 3
A13032.0	–	32.00	1.2598	185.0	334.0	MK 4
A13032.5	–	32.50	1.2795	185.0	334.0	MK 4
A13033.0	–	33.00	1.2992	185.0	334.0	MK 4
A13033.5	–	33.50	1.3189	185.0	334.0	MK 4
A13034.0	–	34.00	1.3386	190.0	339.0	MK 4
A13034.5	–	34.50	1.3583	190.0	339.0	MK 4
A1301.3/8	1.3/8	34.93	1.3750	190.0	339.0	MK 4
A13035.0	–	35.00	1.3780	190.0	339.0	MK 4
A13035.5	–	35.50	1.3976	190.0	339.0	MK 4
A13036.0	–	36.00	1.4173	195.0	344.0	MK 4
A13037.0	–	37.00	1.4567	195.0	344.0	MK 4
A13037.5	–	37.50	1.4764	195.0	344.0	MK 4
A13038.0	–	38.00	1.4961	200.0	349.0	MK 4
A1301.1/2	1.1/2	38.10	1.5000	200.0	349.0	MK 4
A13038.5	–	38.50	1.5157	200.0	349.0	MK 4
A13039.0	–	39.00	1.5354	200.0	349.0	MK 4
A13039.5	–	39.50	1.5551	200.0	349.0	MK 4
A13040.0	–	40.00	1.5748	200.0	349.0	MK 4
A13041.0	–	41.00	1.6142	205.0	354.0	MK 4
A13042.0	–	42.00	1.6535	205.0	354.0	MK 4
A13043.0	–	43.00	1.6929	210.0	359.0	MK 4
A13044.0	–	44.00	1.7323	210.0	359.0	MK 4
A1301.3/4	1.3/4	44.45	1.7500	210.0	359.0	MK 4
A13045.0	–	45.00	1.7717	210.0	359.0	MK 4
A13046.0	–	46.00	1.8110	215.0	364.0	MK 4
A13048.0	–	48.00	1.8898	220.0	369.0	MK 4
A13049.0	–	49.00	1.9291	220.0	369.0	MK 4
A13050.0	–	50.00	1.9685	220.0	369.0	MK 4
A1302	2"	50.80	2.0000	225.0	374.0	MK 4

A002



Broca HSS Serie Corta, con la Punta Recubierta TiN

Broca versátil para taladrado manual y en máquina. Punta dividida a 118° especialmente diseñada para ayudar a autocentrar la broca cuando se taladra a mano y proporciona un agujero de tamaño más preciso. Apta para muchos materiales. El recubrimiento TiN-Tip mejora el rendimiento y prolonga la vida útil de la herramienta.

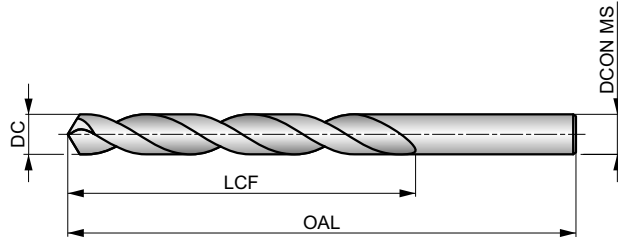

HSS	DIN 338	4×D
118°	TiN-Tip	
λ 20-35°	R	DC h8

Grupo de Material de la pieza adecuado y condiciones de velocidad de corte iniciales (m/min) y código de avance alfabético. Tablas con avance por revolución a partir de la pag.274.

P1.1 ■ 46 J	P1.2 ■ 52 J	P1.3 ■ 54 J	P2.1 ■ 40 J	P2.2 ■ 35 F	P2.3 ■ 31 F	P3.1 ■ 27 F	P3.2 ■ 21 F	P3.3 ■ 18 F	P4.1 ■ 16 F	P4.2 ■ 13 F	P4.3 ■ 11 E	M1.1 ■ 27 F	M1.2 ■ 23 F
M2.1 ■ 24 F	M2.2 ■ 20 F	M3.1 ■ 14 G	M3.2 ■ 12 G	M3.3 ■ 11 G	M4.1 ■ 16 C	K1.1 ■ 40 J	K1.2 ■ 30 E	K1.3 ■ 22 E	K2.1 ■ 34 E	K2.2 ■ 28 E	K2.3 ■ 22 E	K3.1 ■ 30 E	K3.2 ■ 23 E
K3.3 ■ 19 E	K4.1 ■ 28 E	K4.2 ■ 21 E	K4.3 ■ 16 E	K4.4 ■ 13 E	K4.5 ■ 11 E	K5.1 ■ 32 E	K5.2 ■ 24 E	K5.3 ■ 19 E	N1.1 ■ 41 K	N1.2 ■ 31 K	N1.3 ■ 21 J	N2.1 ■ 51 I	N2.2 ■ 46 I
N2.3 ■ 33 I	N3.1 ■ 56 H	N3.2 ■ 33 I	N3.3 ■ 17 G	N4.1 ■ 30 I	N4.2 ■ 50 H	N4.3 ■ 35 F	S1.1 ■ 23 F	S1.2 ■ 13 D	S1.3 ■ 7 B	S2.1 ■ 9 E	S2.2 ■ 4 A	S3.1 ■ 7 E	S3.2 ■ 3 A
S4.1 ■ 5 E	S4.2 ■ 2 A												

DC < 2mm Brillante; DC >= 2mm Punta rectificada en cruz y recubierta TiN
 Los productos de esta serie también están disponibles en forma de Set. Por favor, vea A087, A089 A094, A095 o A099.

Product	DC (inch)	DC (mm)	DC (inch)	LCF (mm)	OAL (mm)	DCON MS (mm)
A0021.0	—	1.00	0.0394	12.0	34.0	1.00
A0021.1	—	1.10	0.0433	14.0	36.0	1.10
A0023/64	3/64	1.19	0.0469	16.0	38.0	1.19
A0021.2	—	1.20	0.0472	16.0	38.0	1.20
A0021.3	—	1.30	0.0512	16.0	38.0	1.30
A0021.4	—	1.40	0.0551	18.0	40.0	1.40
A0021.5	—	1.50	0.0591	18.0	40.0	1.50
A0021/16	1/16	1.59	0.0625	20.0	43.0	1.59
A0021.6	—	1.60	0.0630	20.0	43.0	1.60
A0021.7	—	1.70	0.0669	20.0	43.0	1.70
A0021.8	—	1.80	0.0709	22.0	46.0	1.80
A0021.9	—	1.90	0.0748	22.0	46.0	1.90
A0025/64	5/64	1.98	0.0781	24.0	49.0	1.98
A0022.0	—	2.00	0.0787	24.0	49.0	2.00
A0022.1	—	2.10	0.0827	24.0	49.0	2.10
A0022.2	—	2.20	0.0866	27.0	53.0	2.20
A0022.3	—	2.30	0.0906	27.0	53.0	2.30
A0023/32	3/32	2.38	0.0938	30.0	57.0	2.38
A0022.4	—	2.40	0.0945	30.0	57.0	2.40
A0022.5	—	2.50	0.0984	30.0	57.0	2.50
A0022.6	—	2.60	0.1024	30.0	57.0	2.60
A0022.7	—	2.70	0.1063	33.0	61.0	2.70

Product	DC (inch)	DC (mm)	DC (inch)	LCF (mm)	OAL (mm)	DCON MS (mm)
A0027/64	7/64	2.78	0.1094	33.0	61.0	2.78
A0022.8	—	2.80	0.1102	33.0	61.0	2.80
A0022.9	—	2.90	0.1142	33.0	61.0	2.90
A0023.0	—	3.00	0.1181	33.0	61.0	3.00
A0023.1	—	3.10	0.1220	36.0	65.0	3.10
A0021/8	1/8	3.18	0.1250	36.0	65.0	3.18
A0023.2	—	3.20	0.1260	36.0	65.0	3.20
A0023.25	—	3.25	0.1280	36.0	65.0	3.25
A0023.3	—	3.30	0.1299	36.0	65.0	3.30
A0023.4	—	3.40	0.1339	39.0	70.0	3.40
A0023.5	—	3.50	0.1378	39.0	70.0	3.50
A0029/64	9/64	3.57	0.1406	39.0	70.0	3.57
A0023.6	—	3.60	0.1417	39.0	70.0	3.60
A0023.7	—	3.70	0.1457	39.0	70.0	3.70
A0023.8	—	3.80	0.1496	43.0	75.0	3.80
A0023.9	—	3.90	0.1535	43.0	75.0	3.90
A0025/32	5/32	3.97	0.1563	43.0	75.0	3.97
A0024.0	—	4.00	0.1575	43.0	75.0	4.00
A0024.1	—	4.10	0.1614	43.0	75.0	4.10
A0024.2	—	4.20	0.1654	43.0	75.0	4.20
A0024.3	—	4.30	0.1693	47.0	80.0	4.30
A00211/64	11/64	4.37	0.1719	47.0	80.0	4.37



Product	DC	DC	DC	LCF	OAL	D CON MS
	(inch)	(mm)	(inch)	(mm)	(mm)	(mm)
A0024.4	–	4.40	0.1732	47.0	80.0	4.40
A0024.5	–	4.50	0.1772	47.0	80.0	4.50
A0024.6	–	4.60	0.1811	47.0	80.0	4.60
A0024.7	–	4.70	0.1850	47.0	80.0	4.70
A0023/16	3/16	4.76	0.1875	52.0	86.0	4.76
A0024.8	–	4.80	0.1890	52.0	86.0	4.80
A0024.9	–	4.90	0.1929	52.0	86.0	4.90
A0025.0	–	5.00	0.1969	52.0	86.0	5.00
A0025.1	–	5.10	0.2008	52.0	86.0	5.10
A00213/64	13/64	5.16	0.2031	52.0	86.0	5.16
A0025.2	–	5.20	0.2047	52.0	86.0	5.20
A0025.3	–	5.30	0.2087	52.0	86.0	5.30
A0025.4	–	5.40	0.2126	57.0	93.0	5.40
A0025.5	–	5.50	0.2165	57.0	93.0	5.50
A0027/32	7/32	5.56	0.2188	57.0	93.0	5.56
A0025.6	–	5.60	0.2205	57.0	93.0	5.60
A0025.7	–	5.70	0.2244	57.0	93.0	5.70
A0025.8	–	5.80	0.2283	57.0	93.0	5.80
A0025.9	–	5.90	0.2323	57.0	93.0	5.90
A00215/64	15/64	5.95	0.2344	57.0	93.0	5.95
A0026.0	–	6.00	0.2362	57.0	93.0	6.00
A0026.1	–	6.10	0.2402	63.0	101.0	6.10
A0026.2	–	6.20	0.2441	63.0	101.0	6.20
A0026.3	–	6.30	0.2480	63.0	101.0	6.30
A0021/4	1/4	6.35	0.2500	63.0	101.0	6.35
A0026.4	–	6.40	0.2520	63.0	101.0	6.40
A0026.5	–	6.50	0.2559	63.0	101.0	6.50
A0026.6	–	6.60	0.2598	63.0	101.0	6.60
A0026.7	–	6.70	0.2638	63.0	101.0	6.70
A00217/64	17/64	6.75	0.2656	69.0	109.0	6.75
A0026.8	–	6.80	0.2677	69.0	109.0	6.80
A0026.9	–	6.90	0.2717	69.0	109.0	6.90
A0027.0	–	7.00	0.2756	69.0	109.0	7.00
A0027.1	–	7.10	0.2795	69.0	109.0	7.10
A0029/32	9/32	7.14	0.2813	69.0	109.0	7.14
A0027.2	–	7.20	0.2835	69.0	109.0	7.20
A0027.3	–	7.30	0.2874	69.0	109.0	7.30
A0027.4	–	7.40	0.2913	69.0	109.0	7.40
A0027.5	–	7.50	0.2953	69.0	109.0	7.50
A00219/64	19/64	7.54	0.2969	75.0	117.0	7.54
A0027.6	–	7.60	0.2992	75.0	117.0	7.60
A0027.7	–	7.70	0.3031	75.0	117.0	7.70
A0027.8	–	7.80	0.3071	75.0	117.0	7.80
A0027.9	–	7.90	0.3110	75.0	117.0	7.90
A0025/16	5/16	7.94	0.3125	75.0	117.0	7.94
A0028.0	–	8.00	0.3150	75.0	117.0	8.00
A0028.1	–	8.10	0.3189	75.0	117.0	8.10
A0028.2	–	8.20	0.3228	75.0	117.0	8.20
A0028.3	–	8.30	0.3268	75.0	117.0	8.30
A00221/64	21/64	8.33	0.3281	75.0	117.0	8.33
A0028.4	–	8.40	0.3307	75.0	117.0	8.40
A0028.5	–	8.50	0.3346	75.0	117.0	8.50
A0028.6	–	8.60	0.3386	81.0	125.0	8.60
A0028.7	–	8.70	0.3425	81.0	125.0	8.70
A00211/32	11/32	8.73	0.3438	81.0	125.0	8.73
A0028.8	–	8.80	0.3465	81.0	125.0	8.80
A0028.9	–	8.90	0.3504	81.0	125.0	8.90
A0029.0	–	9.00	0.3543	81.0	125.0	9.00
A0029.1	–	9.10	0.3583	81.0	125.0	9.10
A00223/64	23/64	9.13	0.3594	81.0	125.0	9.13
A0029.2	–	9.20	0.3622	81.0	125.0	9.20
A0029.3	–	9.30	0.3661	81.0	125.0	9.30
A0029.4	–	9.40	0.3701	81.0	125.0	9.40
A0029.5	–	9.50	0.3740	81.0	125.0	9.50
A0023/8	3/8	9.52	0.3750	87.0	133.0	9.52
A0029.6	–	9.60	0.3780	87.0	133.0	9.60
A0029.7	–	9.70	0.3819	87.0	133.0	9.70

Product	DC	DC	DC	LCF	OAL	D CON MS
	(inch)	(mm)	(inch)	(mm)	(mm)	(mm)
A0029.8	–	9.80	0.3858	87.0	133.0	9.80
A0029.9	–	9.90	0.3898	87.0	133.0	9.90
A00225/64	25/64	9.92	0.3906	87.0	133.0	9.92
A00210.0	–	10.00	0.3937	87.0	133.0	10.00
A00210.1	–	10.10	0.3976	87.0	133.0	10.10
A00210.2	–	10.20	0.4016	87.0	133.0	10.20
A00210.3	–	10.30	0.4055	87.0	133.0	10.30
A00213/32	13/32	10.32	0.4063	87.0	133.0	10.32
A00210.4	–	10.40	0.4094	87.0	133.0	10.40
A00210.5	–	10.50	0.4134	87.0	133.0	10.50
A00210.6	–	10.60	0.4173	87.0	133.0	10.60
A00210.7	–	10.70	0.4213	94.0	142.0	10.70
A00227/64	27/64	10.72	0.4219	94.0	142.0	10.72
A00210.8	–	10.80	0.4252	94.0	142.0	10.80
A00210.9	–	10.90	0.4291	94.0	142.0	10.90
A00211.0	–	11.00	0.4331	94.0	142.0	11.00
A00211.1	–	11.10	0.4370	94.0	142.0	11.10
A0027/16	7/16	11.11	0.4375	94.0	142.0	11.11
A00211.2	–	11.20	0.4409	94.0	142.0	11.20
A00211.3	–	11.30	0.4449	94.0	142.0	11.30
A00211.4	–	11.40	0.4488	94.0	142.0	11.40
A00211.5	–	11.50	0.4528	94.0	142.0	11.50
A00229/64	29/64	11.51	0.4531	94.0	142.0	11.51
A00211.6	–	11.60	0.4567	94.0	142.0	11.60
A00211.7	–	11.70	0.4606	94.0	142.0	11.70
A00211.8	–	11.80	0.4646	94.0	142.0	11.80
A00211.9	–	11.90	0.4685	101.0	151.0	11.90
A00215/32	15/32	11.91	0.4688	101.0	151.0	11.91
A00212.0	–	12.00	0.4724	101.0	151.0	12.00
A00212.1	–	12.10	0.4764	101.0	151.0	12.10
A00212.2	–	12.20	0.4803	101.0	151.0	12.20
A00212.3	–	12.30	0.4843	101.0	151.0	12.30
A00231/64	31/64	12.30	0.4844	101.0	151.0	12.30
A00212.4	–	12.40	0.4882	101.0	151.0	12.40
A00212.5	–	12.50	0.4921	101.0	151.0	12.50
A00212.6	–	12.60	0.4961	101.0	151.0	12.60
A00212.7	–	12.70	0.5000	101.0	151.0	12.70
A0021/2	1/2	12.70	0.5000	101.0	151.0	12.70
A00212.8	–	12.80	0.5039	101.0	151.0	12.80
A00212.9	–	12.90	0.5079	101.0	151.0	12.90
A00213.0	–	13.00	0.5118	101.0	151.0	13.00
A00233/64	33/64	13.10	0.5156	101.0	151.0	13.10
A00213.1	–	13.10	0.5157	101.0	151.0	13.10
A00213.2	–	13.20	0.5197	101.0	151.0	13.20
A00213.25	–	13.25	0.5217	108.0	160.0	13.25
A00213.3	–	13.30	0.5236	108.0	160.0	13.30
A00213.4	–	13.40	0.5276	108.0	160.0	13.40
A00217/32	17/32	13.49	0.5313	108.0	160.0	13.49
A00213.5	–	13.50	0.5315	108.0	160.0	13.50
A00213.6	–	13.60	0.5354	108.0	160.0	13.60
A00213.7	–	13.70	0.5394	108.0	160.0	13.70
A00213.75	–	13.75	0.5413	108.0	160.0	13.75
A00213.8	–	13.80	0.5433	108.0	160.0	13.80
A00213.9	–	13.90	0.5472	108.0	160.0	13.90
A00214.0	–	14.00	0.5512	108.0	160.0	14.00
A00214.25	–	14.25	0.5610	114.0	169.0	14.25
A0029/16	9/16	14.29	0.5625	114.0	169.0	14.29
A00214.5	–	14.50	0.5709	114.0	169.0	14.50
A00214.75	–	14.75	0.5807	114.0	169.0	14.75
A00215.0	–	15.00	0.5906	114.0	169.0	15.00
A00219/32	19/32	15.08	0.5938	120.0	178.0	15.08
A00215.25	–	15.25	0.6004	120.0	178.0	15.25
A00215.5	–	15.50	0.6102	120.0	178.0	15.50
A00215.75	–	15.75	0.6201	120.0	178.0	15.75
A0025/8	5/8	15.88	0.6250	120.0	178.0	15.88
A00216.0	–	16.00	0.6299	120.0	178.0	16.00

A002S



Broca HSS Serie Corta, con la Punta Recubierta TiN, en Blister

Broca versátil para taladrado manual y en máquina. Punta dividida a 118° especialmente diseñada para ayudar a autocentrar la broca cuando se taladra a mano y proporciona un agujero de tamaño más preciso. Apta para muchos materiales. El recubrimiento TiN-Tip mejora el rendimiento y prolonga la vida útil de la herramienta.

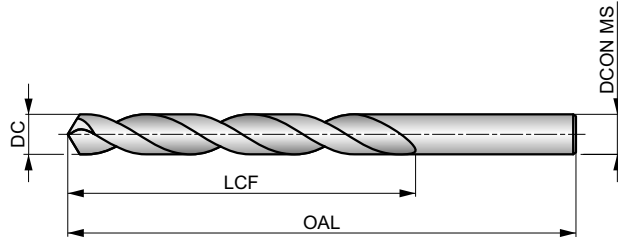

HSS	DIN 338	4×D
118°	TiN-Tip	
λ 20-35°	R	DC h8

Grupo de Material de la pieza adecuado y condiciones de velocidad de corte iniciales (m/min) y código de avance alfabético. Tablas con avance por revolución a partir de la pag.274.

P1.1 ■ 46 J	P1.2 ■ 52 J	P1.3 ■ 54 J	P2.1 ■ 40 J	P2.2 ■ 35 F	P2.3 ■ 31 F	P3.1 ■ 27 F	P3.2 ■ 21 F	P3.3 ■ 18 F	P4.1 ■ 16 F	P4.2 ■ 13 F	P4.3 ■ 11 E	M1.1 ■ 27 F	M1.2 ■ 23 F
M2.1 ■ 24 F	M2.2 ■ 20 F	M3.1 ■ 14 G	M3.2 ■ 12 G	M3.3 ■ 11 G	M4.1 ■ 16 C	K1.1 ■ 40 J	K1.2 ■ 30 E	K1.3 ■ 22 E	K2.1 ■ 34 E	K2.2 ■ 28 E	K2.3 ■ 22 E	K3.1 ■ 30 E	K3.2 ■ 23 E
K3.3 ■ 19 E	K4.1 ■ 28 E	K4.2 ■ 21 E	K4.3 ■ 16 E	K4.4 ■ 13 E	K4.5 ■ 11 E	K5.1 ■ 32 E	K5.2 ■ 24 E	K5.3 ■ 19 E	N1.1 ■ 41 K	N1.2 ■ 31 K	N1.3 ■ 21 J	N2.1 ■ 51 I	N2.2 ■ 46 I
N2.3 ■ 33 I	N3.1 ■ 56 H	N3.2 ■ 33 I	N3.3 ■ 17 G	N4.1 ■ 30 I	N4.2 ■ 50 H	N4.3 ■ 35 F	S1.1 ■ 23 F	S1.2 ■ 13 D	S1.3 ■ 7 B	S2.1 ■ 9 E	S2.2 ■ 4 A	S3.1 ■ 7 E	S3.2 ■ 3 A
S4.1 ■ 5 E	S4.2 ■ 2 A												

DC <= 5mm Se vende en paquetes de 2.

Product	DC (inch)	DC (mm)	DC (inch)	LCF (mm)	OAL (mm)	DCON MS (mm)
A00252.0	-	2.00	0.0787	24.0	49.0	2.00
A00252.5	-	2.50	0.0984	30.0	57.0	2.50
A00253.0	-	3.00	0.1181	33.0	61.0	3.00
A00251/8	1/8	3.18	0.1250	36.0	65.0	3.18
A00253.2	-	3.20	0.1260	36.0	65.0	3.20
A00253.3	-	3.30	0.1299	36.0	65.0	3.30
A00253.5	-	3.50	0.1378	39.0	70.0	3.50
A00255/32	5/32	3.97	0.1563	43.0	75.0	3.97
A00254.0	-	4.00	0.1575	43.0	75.0	4.00
A00254.1	-	4.10	0.1614	43.0	75.0	4.10
A00254.2	-	4.20	0.1654	43.0	75.0	4.20
A00254.5	-	4.50	0.1772	47.0	80.0	4.50
A00253/16	3/16	4.76	0.1875	52.0	86.0	4.76
A00255.0	-	5.00	0.1969	52.0	86.0	5.00
A002513/64	13/64	5.16	0.2031	52.0	86.0	5.16
A00255.5	-	5.50	0.2165	57.0	93.0	5.50
A00257/32	7/32	5.56	0.2188	57.0	93.0	5.56
A00256.0	-	6.00	0.2362	57.0	93.0	6.00
A00251/4	1/4	6.35	0.2500	63.0	101.0	6.35
A00256.5	-	6.50	0.2559	63.0	101.0	6.50

Product	DC (inch)	DC (mm)	DC (inch)	LCF (mm)	OAL (mm)	DCON MS (mm)
A00256.8	-	6.80	0.2677	69.0	109.0	6.80
A00257.0	-	7.00	0.2756	69.0	109.0	7.00
A00257.5	-	7.50	0.2953	69.0	109.0	7.50
A00255/16	5/16	7.94	0.3125	75.0	117.0	7.94
A00258.0	-	8.00	0.3150	75.0	117.0	8.00
A00258.2	-	8.20	0.3228	75.0	117.0	8.20
A00258.5	-	8.50	0.3346	75.0	117.0	8.50
A00259.0	-	9.00	0.3543	81.0	125.0	9.00
A00259.5	-	9.50	0.3740	81.0	125.0	9.50
A00253/8	3/8	9.52	0.3750	87.0	133.0	9.52
A002510.0	-	10.00	0.3937	87.0	133.0	10.00
A002510.2	-	10.20	0.4016	87.0	133.0	10.20
A002510.5	-	10.50	0.4134	87.0	133.0	10.50
A002511.0	-	11.00	0.4331	94.0	142.0	11.00
A002511.5	-	11.50	0.4528	94.0	142.0	11.50
A002512.0	-	12.00	0.4724	101.0	151.0	12.00
A002512.5	-	12.50	0.4921	101.0	151.0	12.50
A00251/2	1/2	12.70	0.5000	101.0	151.0	12.70
A002513.0	-	13.00	0.5118	101.0	151.0	13.00

A108



Broca HSS, Serie Corta, Acabado Templado al Vapor (Diseñada para Acero Inoxidable)

Primera elección para taladrar acero inoxidable en aplicaciones manuales, aunque también se puede utilizar eficazmente en máquinas. La punta dividida a 135° mejora el autocentrado y reduce las fuerzas de corte. El acabado templado al vapor ayuda a evitar que el material de la pieza se adhiera al filo.

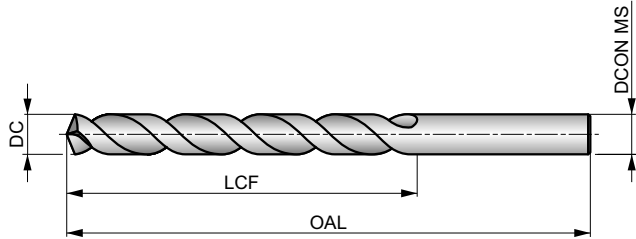

HSS	DIN 338	4×D
135°	ST	
λ>35°	R	DC h8

Grupo de Material de la pieza adecuado y condiciones de velocidad de corte iniciales (m/min) y código de avance alfabético. Tablas con avance por revolución a partir de la pag.274.

P1.1 33 I	P1.2 37 I	P1.3 38 I	P2.1 28 I	P2.2 25 G	P2.3 22 E	P3.1 19 F	P3.2 15 F	P3.3 13 E	P4.1 11 F	P4.2 10 E	P4.3 8 D	M1.1 21 E	M1.2 17 E
M2.1 18 E	M2.2 15 E	M3.1 10 G	M3.2 9 G	M3.3 8 G	M4.1 10 D	K1.1 30 H	K1.2 22 F	K1.3 17 F	K2.1 25 E	K2.2 20 E	K2.3 16 E	K3.1 22 E	K3.2 17 E
K3.3 13 E	K4.1 20 E	K4.2 15 E	K4.3 11 E	K4.4 10 E	K4.5 8 E	K5.1 23 E	K5.2 17 E	K5.3 13 E	N1.1 33 J	N1.2 25 J	N1.3 17 I	N2.1 42 H	N2.2 37 H
N2.3 27 H	N3.1 59 H	N3.2 35 I	N3.3 18 G	N4.1 30 J	N4.2 28 H	N4.3 14 F	S1.1 25 G	S1.2 16 E	S1.3 7 B	S2.1 9 G	S2.2 8 E	S3.1 7 G	S3.2 6 E
S4.1 5 G	S4.2 5 E												











DC > 1.5mm (1/16") Afilado en Cruz
Los productos de esta serie también están disponibles en forma de Set. Por favor, vea A188.

Product	DC (inch)	DC (mm)	DC (inch)	LCF (mm)	OAL (mm)	DCON MS (mm)
A1081.0	-	1.00	0.0394	12.0	34.0	1.00
A1081.1	-	1.10	0.0433	14.0	36.0	1.10
A1081.2	-	1.20	0.0472	16.0	38.0	1.20
A1081.3	-	1.30	0.0512	16.0	38.0	1.30
A1081.4	-	1.40	0.0551	18.0	40.0	1.40
A1081.5	-	1.50	0.0591	18.0	40.0	1.50
A1081/16	1/16	1.59	0.0625	20.0	43.0	1.59
A1081.6	-	1.60	0.0630	20.0	43.0	1.60
A1081.7	-	1.70	0.0669	20.0	43.0	1.70
A1081.8	-	1.80	0.0709	22.0	46.0	1.80
A1081.9	-	1.90	0.0748	22.0	46.0	1.90
A1085/64	5/64	1.98	0.0781	24.0	49.0	1.98
A1082.0	-	2.00	0.0787	24.0	49.0	2.00
A1082.1	-	2.10	0.0827	24.0	49.0	2.10
A1082.2	-	2.20	0.0866	27.0	53.0	2.20
A1082.3	-	2.30	0.0906	27.0	53.0	2.30
A1083/32	3/32	2.38	0.0938	30.0	57.0	2.38
A1082.4	-	2.40	0.0945	30.0	57.0	2.40
A1082.5	-	2.50	0.0984	30.0	57.0	2.50
A1082.6	-	2.60	0.1024	30.0	57.0	2.60
A1082.7	-	2.70	0.1063	33.0	61.0	2.70
A1087/64	7/64	2.78	0.1094	33.0	61.0	2.78



Product	DC (inch)	DC (mm)	DC (inch)	LCF (mm)	OAL (mm)	DCON MS (mm)
A1082.8	-	2.80	0.1102	33.0	61.0	2.80
A1082.9	-	2.90	0.1142	33.0	61.0	2.90
A1083.0	-	3.00	0.1181	33.0	61.0	3.00
A1083.1	-	3.10	0.1220	36.0	65.0	3.10
A1081/8	1/8	3.18	0.1250	36.0	65.0	3.18
A1083.2	-	3.20	0.1260	36.0	65.0	3.20
A1083.3	-	3.30	0.1299	36.0	65.0	3.30
A1083.4	-	3.40	0.1339	39.0	70.0	3.40
A1083.5	-	3.50	0.1378	39.0	70.0	3.50
A1089/64	9/64	3.57	0.1406	39.0	70.0	3.57
A1083.6	-	3.60	0.1417	39.0	70.0	3.60
A1083.7	-	3.70	0.1457	39.0	70.0	3.70
A1083.8	-	3.80	0.1496	43.0	75.0	3.80
A1083.9	-	3.90	0.1535	43.0	75.0	3.90
A1085/32	5/32	3.97	0.1563	43.0	75.0	3.97
A1084.0	-	4.00	0.1575	43.0	75.0	4.00
A1084.1	-	4.10	0.1614	43.0	75.0	4.10
A1084.2	-	4.20	0.1654	43.0	75.0	4.20
A1084.3	-	4.30	0.1693	47.0	80.0	4.30
A10811/64	11/64	4.37	0.1719	47.0	80.0	4.37
A1084.4	-	4.40	0.1732	47.0	80.0	4.40
A1084.5	-	4.50	0.1772	47.0	80.0	4.50

Product	DC	DC	DC	LCF	OAL	D CON MS
	(inch)	(mm)	(inch)	(mm)	(mm)	(mm)
A1084.6	–	4.60	0.1811	47.0	80.0	4.60
A1084.7	–	4.70	0.1850	47.0	80.0	4.70
A1083/16	3/16	4.76	0.1875	52.0	86.0	4.76
A1084.8	–	4.80	0.1890	52.0	86.0	4.80
A1084.9	–	4.90	0.1929	52.0	86.0	4.90
A108N10	N10	4.92	0.1935	52.0	86.0	4.92
A1085.0	–	5.00	0.1969	52.0	86.0	5.00
A1085.1	–	5.10	0.2008	52.0	86.0	5.10
A10813/64	13/64	5.16	0.2031	52.0	86.0	5.16
A1085.2	–	5.20	0.2047	52.0	86.0	5.20
A1085.3	–	5.30	0.2087	52.0	86.0	5.30
A1085.4	–	5.40	0.2126	57.0	93.0	5.40
A1085.5	–	5.50	0.2165	57.0	93.0	5.50
A1087/32	7/32	5.56	0.2188	57.0	93.0	5.56
A1085.6	–	5.60	0.2205	57.0	93.0	5.60
A1085.7	–	5.70	0.2244	57.0	93.0	5.70
A1085.8	–	5.80	0.2283	57.0	93.0	5.80
A1085.9	–	5.90	0.2323	57.0	93.0	5.90
A10815/64	15/64	5.95	0.2344	57.0	93.0	5.95
A1086.0	–	6.00	0.2362	57.0	93.0	6.00
A1086.1	–	6.10	0.2402	63.0	101.0	6.10
A1086.2	–	6.20	0.2441	63.0	101.0	6.20
A1086.3	–	6.30	0.2480	63.0	101.0	6.30
A1081/4	1/4	6.35	0.2500	63.0	101.0	6.35
A1086.4	–	6.40	0.2520	63.0	101.0	6.40
A1086.5	–	6.50	0.2559	63.0	101.0	6.50
A1086.6	–	6.60	0.2598	63.0	101.0	6.60
A1086.7	–	6.70	0.2638	63.0	101.0	6.70
A10817/64	17/64	6.75	0.2656	69.0	109.0	6.75
A1086.8	–	6.80	0.2677	69.0	109.0	6.80
A1086.9	–	6.90	0.2717	69.0	109.0	6.90
A1087.0	–	7.00	0.2756	69.0	109.0	7.00
A1087.1	–	7.10	0.2795	69.0	109.0	7.10
A1089/32	9/32	7.14	0.2813	69.0	109.0	7.14
A1087.2	–	7.20	0.2835	69.0	109.0	7.20
A1087.3	–	7.30	0.2874	69.0	109.0	7.30
A1087.4	–	7.40	0.2913	69.0	109.0	7.40
A1087.5	–	7.50	0.2953	69.0	109.0	7.50
A10819/64	19/64	7.54	0.2969	75.0	117.0	7.54
A1087.6	–	7.60	0.2992	75.0	117.0	7.60
A1087.7	–	7.70	0.3031	75.0	117.0	7.70
A1087.8	–	7.80	0.3071	75.0	117.0	7.80
A1087.9	–	7.90	0.3110	75.0	117.0	7.90
A1085/16	5/16	7.94	0.3125	75.0	117.0	7.94
A1088.0	–	8.00	0.3150	75.0	117.0	8.00
A1088.1	–	8.10	0.3189	75.0	117.0	8.10
A1088.2	–	8.20	0.3228	75.0	117.0	8.20

Product	DC	DC	DC	LCF	OAL	D CON MS
	(inch)	(mm)	(inch)	(mm)	(mm)	(mm)
A1088.3	–	8.30	0.3268	75.0	117.0	8.30
A10821/64	21/64	8.33	0.3281	75.0	117.0	8.33
A1088.4	–	8.40	0.3307	75.0	117.0	8.40
A1088.5	–	8.50	0.3346	75.0	117.0	8.50
A1088.6	–	8.60	0.3386	81.0	125.0	8.60
A1088.7	–	8.70	0.3425	81.0	125.0	8.70
A10811/32	11/32	8.73	0.3438	81.0	125.0	8.73
A1088.8	–	8.80	0.3465	81.0	125.0	8.80
A1088.9	–	8.90	0.3504	81.0	125.0	8.90
A1089.0	–	9.00	0.3543	81.0	125.0	9.00
A1089.1	–	9.10	0.3583	81.0	125.0	9.10
A10823/64	23/64	9.13	0.3594	81.0	125.0	9.13
A1089.2	–	9.20	0.3622	81.0	125.0	9.20
A1089.3	–	9.30	0.3661	81.0	125.0	9.30
A1089.4	–	9.40	0.3701	81.0	125.0	9.40
A1089.5	–	9.50	0.3740	81.0	125.0	9.50
A1083/8	3/8	9.52	0.3750	87.0	133.0	9.52
A1089.6	–	9.60	0.3780	87.0	133.0	9.60
A1089.7	–	9.70	0.3819	87.0	133.0	9.70
A1089.8	–	9.80	0.3858	87.0	133.0	9.80
A1089.9	–	9.90	0.3898	87.0	133.0	9.90
A10825/64	25/64	9.92	0.3906	87.0	133.0	9.92
A10810.0	–	10.00	0.3937	87.0	133.0	10.00
A10810.2	–	10.20	0.4016	87.0	133.0	10.20
A10813/32	13/32	10.32	0.4063	87.0	133.0	10.32
A10810.5	–	10.50	0.4134	87.0	133.0	10.50
A10827/64	27/64	10.72	0.4219	94.0	142.0	10.72
A10810.8	–	10.80	0.4252	94.0	142.0	10.80
A10811.0	–	11.00	0.4331	94.0	142.0	11.00
A1087/16	7/16	11.11	0.4375	94.0	142.0	11.11
A10811.5	–	11.50	0.4528	94.0	142.0	11.50
A10829/64	29/64	11.51	0.4531	94.0	142.0	11.51
A10811.8	–	11.80	0.4646	94.0	142.0	11.80
A10815/32	15/32	11.91	0.4688	101.0	151.0	11.91
A10812.0	–	12.00	0.4724	101.0	151.0	12.00
A10812.2	–	12.20	0.4803	101.0	151.0	12.20
A10831/64	31/64	12.30	0.4844	101.0	151.0	12.30
A10812.5	–	12.50	0.4921	101.0	151.0	12.50
A1081/2	1/2	12.70	0.5000	101.0	151.0	12.70
A10812.8	–	12.80	0.5039	101.0	151.0	12.80
A10813.0	–	13.00	0.5118	101.0	151.0	13.00
A10813.5	–	13.50	0.5315	108.0	160.0	13.50
A10814.0	–	14.00	0.5512	108.0	160.0	14.00
A10814.5	–	14.50	0.5709	114.0	169.0	14.50
A10815.0	–	15.00	0.5906	114.0	169.0	15.00
A10815.25	–	15.25	0.6004	120.0	178.0	15.25
A10816.0	–	16.00	0.6299	120.0	178.0	16.00

Código de Material (BMC)	HSS	HSS																	
Grupo básico estándar (BSG)	DIN 340	BS 328																	
Longitud Útil (ULDR)	6×D	10×D																	
Ángulo de aplicación																			
Recubrimiento																			
Mango																			
Forma de la Hélice																			
Mano (dirección de corte)																			



Código de Familia de Producto		A110	A125																
Gama de diámetros de corte PSF		0.50 - 1"	1.40 - 3/4																
		 36	 38																
P	P1	■	■																
	P2	■	■																
	P3	■	■																
	P4	■	■																
M	M1	■	■																
	M2	■	■																
	M3	■	■																
	M4	■	■																
K	K1	■	■																
	K2	■	■																
	K3	■	■																
	K4	■	■																
	K5	■	■																
N	N1	■	■																
	N2	■	■																
	N3	■	■																
	N4	■	■																
	N5	■	■																
S	S1	■	■																
	S2	■	■																
	S3	■	■																
	S4	■	■																
H	H1																		
	H2																		
	H3																		
	H4																		

A110



Broca HSS Serie Corta, con Acabado Templado al Vapor

Para taladrar agujeros más profundos. La punta convencional a 118° proporciona resistencia y es fácil de reafilarse, lo que la hace muy rentable. Adecuado para taladrar muchos materiales. El acabado templado al vapor retiene el fluido de corte y evita la soldadura de la viruta a la herramienta. Para taladrados manuales y máquinas.

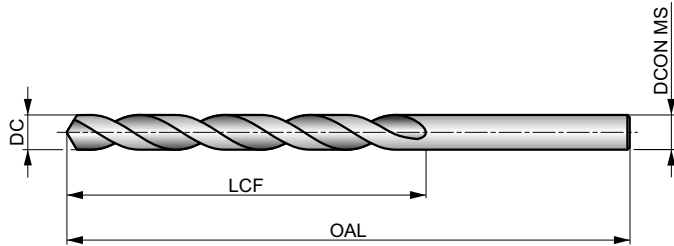

HSS	DIN 340	6×D
118°	ST	
λ 20-35°	R	DC h8

DC ≤ 1mm; 1/16° Brillante

Product	DC (inch)	DC (mm)	DC (inch)	LCF (mm)	OAL (mm)	DCON MS (mm)
A110.5	—	0.50	0.0197	12.0	32.0	0.50
A110.6	—	0.60	0.0236	15.0	35.0	0.60
A110.7	—	0.70	0.0276	21.0	42.0	0.70
A1101/32	1/32	0.79	0.0313	25.0	46.0	0.79
A110.8	—	0.80	0.0315	25.0	46.0	0.80
A110.9	—	0.90	0.0354	29.0	51.0	0.90
A1101.0	—	1.00	0.0394	33.0	56.0	1.00
A1101.1	—	1.10	0.0433	37.0	60.0	1.10
A1101.2	—	1.20	0.0472	41.0	65.0	1.20
A1101.3	—	1.30	0.0512	41.0	65.0	1.30
A1101.4	—	1.40	0.0551	45.0	70.0	1.40
A1101.5	—	1.50	0.0591	45.0	70.0	1.50
A1101/16	1/16	1.59	0.0625	50.0	76.0	1.59
A1101.6	—	1.60	0.0630	50.0	76.0	1.60
A1101.7	—	1.70	0.0669	50.0	76.0	1.70
A1101.75	—	1.75	0.0689	53.0	80.0	1.75
A1101.8	—	1.80	0.0709	53.0	80.0	1.80
A1101.9	—	1.90	0.0748	53.0	80.0	1.90
A1105/64	5/64	1.98	0.0781	56.0	85.0	1.98
A1102.0	—	2.00	0.0787	56.0	85.0	2.00
A1102.05	—	2.05	0.0807	56.0	85.0	2.05
A1102.1	—	2.10	0.0827	56.0	85.0	2.10
A1102.2	—	2.20	0.0866	59.0	90.0	2.20
A1102.25	—	2.25	0.0886	59.0	90.0	2.25
A1102.3	—	2.30	0.0906	59.0	90.0	2.30
A1103/32	3/32	2.38	0.0938	62.0	95.0	2.38
A1102.4	—	2.40	0.0945	62.0	95.0	2.40
A1102.5	—	2.50	0.0984	62.0	95.0	2.50
A1102.6	—	2.60	0.1024	62.0	95.0	2.60
A1102.7	—	2.70	0.1063	66.0	100.0	2.70
A1107/64	7/64	2.78	0.1094	66.0	100.0	2.78
A1102.8	—	2.80	0.1102	66.0	100.0	2.80
A1102.9	—	2.90	0.1142	66.0	100.0	2.90

Product	DC (inch)	DC (mm)	DC (inch)	LCF (mm)	OAL (mm)	DCON MS (mm)
A1103.0	—	3.00	0.1181	66.0	100.0	3.00
A1103.1	—	3.10	0.1220	69.0	106.0	3.10
A1101/8	1/8	3.18	0.1250	69.0	106.0	3.18
A1103.2	—	3.20	0.1260	69.0	106.0	3.20
A1103.25	—	3.25	0.1280	69.0	106.0	3.25
A1103.3	—	3.30	0.1299	69.0	106.0	3.30
A1103.4	—	3.40	0.1339	73.0	112.0	3.40
A1103.5	—	3.50	0.1378	73.0	112.0	3.50
A1109/64	9/64	3.57	0.1406	73.0	112.0	3.57
A1103.6	—	3.60	0.1417	73.0	112.0	3.60
A1103.7	—	3.70	0.1457	73.0	112.0	3.70
A1103.75	—	3.75	0.1476	73.0	112.0	3.75
A1103.8	—	3.80	0.1496	78.0	119.0	3.80
A1103.9	—	3.90	0.1535	78.0	119.0	3.90
A1105/32	5/32	3.97	0.1563	78.0	119.0	3.97
A1104.0	—	4.00	0.1575	78.0	119.0	4.00
A1104.1	—	4.10	0.1614	78.0	119.0	4.10
A1104.2	—	4.20	0.1654	78.0	119.0	4.20
A1104.25	—	4.25	0.1673	78.0	119.0	4.25
A1104.3	—	4.30	0.1693	82.0	126.0	4.30
A11011/64	11/64	4.37	0.1719	82.0	126.0	4.37
A1104.4	—	4.40	0.1732	82.0	126.0	4.40
A1104.5	—	4.50	0.1772	82.0	126.0	4.50
A1104.6	—	4.60	0.1811	82.0	126.0	4.60
A1104.7	—	4.70	0.1850	82.0	126.0	4.70
A1104.75	—	4.75	0.1870	82.0	126.0	4.75
A1103/16	3/16	4.76	0.1875	87.0	132.0	4.76
A1104.8	—	4.80	0.1890	87.0	132.0	4.80
A1104.9	—	4.90	0.1929	87.0	132.0	4.90
A1105.0	—	5.00	0.1969	87.0	132.0	5.00
A1105.1	—	5.10	0.2008	87.0	132.0	5.10
A11013/64	13/64	5.16	0.2031	87.0	132.0	5.16
A1105.2	—	5.20	0.2047	87.0	132.0	5.20

Product	DC	DC	DC	LCF	OAL	D CON MS
	(inch)	(mm)	(inch)	(mm)	(mm)	(mm)
A1105.25	–	5.25	0.2067	87.0	132.0	5.25
A1105.3	–	5.30	0.2087	87.0	132.0	5.30
A1105.4	–	5.40	0.2126	91.0	139.0	5.40
A1105.5	–	5.50	0.2165	91.0	139.0	5.50
A1107/32	7/32	5.56	0.2188	91.0	139.0	5.56
A1105.6	–	5.60	0.2205	91.0	139.0	5.60
A1105.7	–	5.70	0.2244	91.0	139.0	5.70
A1105.75	–	5.75	0.2264	91.0	139.0	5.75
A1105.8	–	5.80	0.2283	91.0	139.0	5.80
A1105.9	–	5.90	0.2323	91.0	139.0	5.90
A11015/64	15/64	5.95	0.2344	91.0	139.0	5.95
A1106.0	–	6.00	0.2362	91.0	139.0	6.00
A1106.1	–	6.10	0.2402	97.0	148.0	6.10
A1106.2	–	6.20	0.2441	97.0	148.0	6.20
A1106.25	–	6.25	0.2461	97.0	148.0	6.25
A1106.3	–	6.30	0.2480	97.0	148.0	6.30
A1101/4	1/4	6.35	0.2500	97.0	148.0	6.35
A1106.4	–	6.40	0.2520	97.0	148.0	6.40
A1106.5	–	6.50	0.2559	97.0	148.0	6.50
A1106.6	–	6.60	0.2598	97.0	148.0	6.60
A1106.7	–	6.70	0.2638	97.0	148.0	6.70
A11017/64	17/64	6.75	0.2656	102.0	156.0	6.75
A1106.75	–	6.75	0.2657	102.0	156.0	6.75
A1106.8	–	6.80	0.2677	102.0	156.0	6.80
A1106.9	–	6.90	0.2717	102.0	156.0	6.90
A1107.0	–	7.00	0.2756	102.0	156.0	7.00
A1107.1	–	7.10	0.2795	102.0	156.0	7.10
A1109/32	9/32	7.14	0.2813	102.0	156.0	7.14
A1107.2	–	7.20	0.2835	102.0	156.0	7.20
A1107.25	–	7.25	0.2854	102.0	156.0	7.25
A1107.3	–	7.30	0.2874	102.0	156.0	7.30
A1107.4	–	7.40	0.2913	102.0	156.0	7.40
A1107.5	–	7.50	0.2953	102.0	156.0	7.50
A1107.6	–	7.60	0.2992	109.0	165.0	7.60
A1107.7	–	7.70	0.3031	109.0	165.0	7.70
A1107.75	–	7.75	0.3051	109.0	165.0	7.75
A1107.8	–	7.80	0.3071	109.0	165.0	7.80
A1107.9	–	7.90	0.3110	109.0	165.0	7.90
A1105/16	5/16	7.94	0.3125	109.0	165.0	7.94
A1108.0	–	8.00	0.3150	109.0	165.0	8.00
A1108.1	–	8.10	0.3189	109.0	165.0	8.10
A1108.2	–	8.20	0.3228	109.0	165.0	8.20
A1108.25	–	8.25	0.3248	109.0	165.0	8.25
A1108.3	–	8.30	0.3268	109.0	165.0	8.30
A1108.4	–	8.40	0.3307	109.0	165.0	8.40
A1108.5	–	8.50	0.3346	109.0	165.0	8.50
A1108.6	–	8.60	0.3386	115.0	175.0	8.60
A1108.7	–	8.70	0.3425	115.0	175.0	8.70
A11011/32	11/32	8.73	0.3438	115.0	175.0	8.73
A1108.75	–	8.75	0.3445	115.0	175.0	8.75
A1108.8	–	8.80	0.3465	115.0	175.0	8.80

Product	DC	DC	DC	LCF	OAL	D CON MS
	(inch)	(mm)	(inch)	(mm)	(mm)	(mm)
A1109.0	–	9.00	0.3543	115.0	175.0	9.00
A1109.1	–	9.10	0.3583	115.0	175.0	9.10
A1109.2	–	9.20	0.3622	115.0	175.0	9.20
A1109.3	–	9.30	0.3661	115.0	175.0	9.30
A1109.5	–	9.50	0.3740	115.0	175.0	9.50
A1103/8	3/8	9.52	0.3750	121.0	184.0	9.52
A1109.6	–	9.60	0.3780	121.0	184.0	9.60
A1109.7	–	9.70	0.3819	121.0	184.0	9.70
A1109.8	–	9.80	0.3858	121.0	184.0	9.80
A1109.9	–	9.90	0.3898	121.0	184.0	9.90
A11010.0	–	10.00	0.3937	121.0	184.0	10.00
A11010.1	–	10.10	0.3976	121.0	184.0	10.10
A11010.2	–	10.20	0.4016	121.0	184.0	10.20
A11010.25	–	10.25	0.4035	121.0	184.0	10.25
A11010.3	–	10.30	0.4055	121.0	184.0	10.30
A11013/32	13/32	10.32	0.4063	121.0	184.0	10.32
A11010.5	–	10.50	0.4134	121.0	184.0	10.50
A11010.75	–	10.75	0.4232	128.0	195.0	10.75
A11010.8	–	10.80	0.4252	128.0	195.0	10.80
A11011.0	–	11.00	0.4331	128.0	195.0	11.00
A1107/16	7/16	11.11	0.4375	128.0	195.0	11.11
A11011.5	–	11.50	0.4528	128.0	195.0	11.50
A11011.75	–	11.75	0.4626	128.0	195.0	11.75
A11012.0	–	12.00	0.4724	134.0	205.0	12.00
A11012.1	–	12.10	0.4764	134.0	205.0	12.10
A11012.25	–	12.25	0.4823	134.0	205.0	12.25
A11012.5	–	12.50	0.4921	134.0	205.0	12.50
A1101/2	1/2	12.70	0.5000	134.0	205.0	12.70
A11013.0	–	13.00	0.5118	134.0	205.0	13.00
A11017/32	17/32	13.49	0.5313	140.0	214.0	13.49
A11013.5	–	13.50	0.5315	140.0	214.0	13.50
A11014.0	–	14.00	0.5512	140.0	214.0	14.00
A1109/16	9/16	14.29	0.5625	144.0	220.0	14.29
A11014.5	–	14.50	0.5709	144.0	220.0	14.50
A11015.0	–	15.00	0.5906	144.0	220.0	15.00
A11015.5	–	15.50	0.6102	149.0	227.0	15.50
A1105/8	5/8	15.88	0.6250	149.0	227.0	15.88
A11016.0	–	16.00	0.6299	149.0	227.0	16.00
A11016.5	–	16.50	0.6496	154.0	235.0	16.50
A11017.0	–	17.00	0.6693	154.0	235.0	17.00
A11017.5	–	17.50	0.6890	158.0	241.0	17.50
A11018.0	–	18.00	0.7087	158.0	241.0	18.00
A11018.5	–	18.50	0.7283	162.0	247.0	18.50
A11019.0	–	19.00	0.7480	162.0	247.0	19.00
A1103/4	3/4	19.05	0.7500	166.0	254.0	19.05
A11019.5	–	19.50	0.7677	166.0	254.0	19.50
A11020.0	–	20.00	0.7874	166.0	254.0	20.00
A11021.0	–	21.00	0.8268	171.0	261.0	21.00
A11022.0	–	22.00	0.8661	176.0	268.0	22.00
A1107/8	7/8	22.22	0.8750	176.0	268.0	22.22
A1101	1"	25.40	1.0000	190.0	290.0	25.40

A125



Broca HSS Serie Extra Larga, Acabado Templado al Vapor

Con acabado templado al vapor y recomendada para agujeros muy profundos o de difícil acceso. Punta convencional a 118°, que proporciona resistencia y ahorra costes en reafilados fáciles. El acabado templado al vapor retiene el fluido de corte y evita la soldadura de la viruta a la herramienta. Menos adecuado para el taladrado manual.

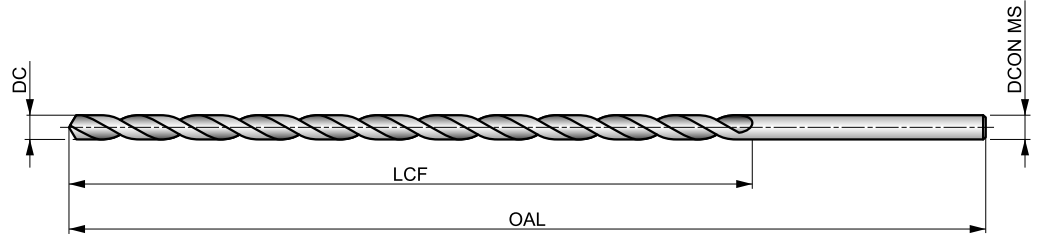

HSS	BS 328	10xD
118°	ST	
λ 20-35°	R	DC h8

DC <= 2.2mm; 5/64" Brillante

Product	DC (inch)	DC (mm)	DC (inch)	LCF (mm)	OAL (mm)	DCON MS (mm)
A1251.4X160	—	1.40	0.0551	100.0	160.0	1.40
A1251.5X125	—	1.50	0.0591	80.0	125.0	1.50
A1251.5X160	—	1.50	0.0591	100.0	160.0	1.50
A1251/16X125	1/16	1.59	0.0625	80.0	125.0	1.59
A1251/16X160	1/16	1.59	0.0625	100.0	160.0	1.59
A1251.8X160	—	1.80	0.0709	100.0	160.0	1.80
A1255/64X125	5/64	1.98	0.0781	80.0	125.0	1.98
A1255/64X160	5/64	1.98	0.0781	100.0	160.0	1.98
A1252.0X125	—	2.00	0.0787	80.0	125.0	2.00
A1252.0X160	—	2.00	0.0787	100.0	160.0	2.00
A1252.2X160	—	2.20	0.0866	100.0	160.0	2.20
A1253/32X125	3/32	2.38	0.0938	80.0	125.0	2.38
A1253/32X160	3/32	2.38	0.0938	100.0	160.0	2.38
A1252.5X125	—	2.50	0.0984	80.0	125.0	2.50
A1252.5X160	—	2.50	0.0984	100.0	160.0	2.50
A1257/64X125	7/64	2.78	0.1094	80.0	125.0	2.78
A1257/64X160	7/64	2.78	0.1094	100.0	160.0	2.78
A1253.0X160	—	3.00	0.1181	100.0	160.0	3.00
A1253.0X200	—	3.00	0.1181	150.0	200.0	3.00
A1253.0X250	—	3.00	0.1181	200.0	250.0	3.00
A1251/8X160	1/8	3.18	0.1250	100.0	160.0	3.18
A1251/8X200	1/8	3.18	0.1250	150.0	200.0	3.18
A1251/8X250	1/8	3.18	0.1250	200.0	250.0	3.18
A1251/8X315	1/8	3.18	0.1250	250.0	310.0	3.18
A1253.3X160	—	3.30	0.1299	100.0	160.0	3.30
A1253.5X160	—	3.50	0.1378	100.0	160.0	3.50
A1253.5X200	—	3.50	0.1378	150.0	200.0	3.50
A1253.5X250	—	3.50	0.1378	200.0	250.0	3.50
A1259/64X160	9/64	3.57	0.1406	100.0	160.0	3.57
A1259/64X200	9/64	3.57	0.1406	150.0	200.0	3.57
A1259/64X315	9/64	3.57	0.1406	250.0	310.0	3.57
A1255/32X160	5/32	3.97	0.1563	100.0	160.0	3.97
A1255/32X200	5/32	3.97	0.1563	150.0	200.0	3.97

Product	DC (inch)	DC (mm)	DC (inch)	LCF (mm)	OAL (mm)	DCON MS (mm)
A1255/32X250	5/32	3.97	0.1563	200.0	250.0	3.97
A1255/32X315	5/32	3.97	0.1563	250.0	310.0	3.97
A1254.0X160	—	4.00	0.1575	100.0	160.0	4.00
A1254.0X200	—	4.00	0.1575	150.0	200.0	4.00
A1254.0X250	—	4.00	0.1575	200.0	250.0	4.00
A1254.0X315	—	4.00	0.1575	250.0	310.0	4.00
A12511/64X160	11/64	4.37	0.1719	100.0	160.0	4.37
A12511/64X200	11/64	4.37	0.1719	150.0	200.0	4.37
A12511/64X315	11/64	4.37	0.1719	250.0	310.0	4.37
A1254.5X160	—	4.50	0.1772	100.0	160.0	4.50
A1254.5X200	—	4.50	0.1772	150.0	200.0	4.50
A1254.5X250	—	4.50	0.1772	200.0	250.0	4.50
A1254.5X315	—	4.50	0.1772	250.0	310.0	4.50
A1253/16X160	3/16	4.76	0.1875	100.0	160.0	4.76
A1253/16X200	3/16	4.76	0.1875	150.0	200.0	4.76
A1253/16X250	3/16	4.76	0.1875	200.0	250.0	4.76
A1253/16X315	3/16	4.76	0.1875	250.0	310.0	4.76
A1253/16X400	3/16	4.76	0.1875	300.0	400.0	4.76
A1255.0X160	—	5.00	0.1969	100.0	160.0	5.00
A1255.0X200	—	5.00	0.1969	150.0	200.0	5.00
A1255.0X250	—	5.00	0.1969	200.0	250.0	5.00
A1255.0X315	—	5.00	0.1969	250.0	310.0	5.00
A1255.0X400	—	5.00	0.1969	300.0	400.0	5.00
A12513/64X200	13/64	5.16	0.2031	150.0	200.0	5.16
A12513/64X250	13/64	5.16	0.2031	200.0	250.0	5.16
A12513/64X315	13/64	5.16	0.2031	250.0	310.0	5.16
A1255.5X200	—	5.50	0.2165	150.0	200.0	5.50
A1255.5X250	—	5.50	0.2165	200.0	250.0	5.50
A1255.5X315	—	5.50	0.2165	250.0	310.0	5.50
A1257/32X200	7/32	5.56	0.2188	150.0	200.0	5.56
A1257/32X250	7/32	5.56	0.2188	200.0	250.0	5.56
A12515/64X200	15/64	5.95	0.2344	150.0	200.0	5.95
A12515/64X315	15/64	5.95	0.2344	250.0	310.0	5.95

Product	DC	DC	DC	LCF	OAL	DCON MS
	(inch)	(mm)	(inch)	(mm)	(mm)	(mm)
A1256.0X200	–	6.00	0.2362	150.0	200.0	6.00
A1256.0X250	–	6.00	0.2362	200.0	250.0	6.00
A1256.0X315	–	6.00	0.2362	250.0	310.0	6.00
A1256.0X400	–	6.00	0.2362	300.0	400.0	6.00
A1251/4X200	1/4	6.35	0.2500	150.0	200.0	6.35
A1251/4X250	1/4	6.35	0.2500	200.0	250.0	6.35
A1251/4X315	1/4	6.35	0.2500	250.0	310.0	6.35
A1251/4X400	1/4	6.35	0.2500	300.0	400.0	6.35
A1251/4X500	1/4	6.35	0.2500	400.0	460.0	6.35
A1256.5X200	–	6.50	0.2559	150.0	200.0	6.50
A1256.5X250	–	6.50	0.2559	200.0	250.0	6.50
A1256.5X315	–	6.50	0.2559	250.0	310.0	6.50
A12517/64X200	17/64	6.75	0.2656	150.0	200.0	6.75
A12517/64X250	17/64	6.75	0.2656	200.0	250.0	6.75
A12517/64X500	17/64	6.75	0.2656	400.0	460.0	6.75
A1257.0X200	–	7.00	0.2756	150.0	200.0	7.00
A1257.0X250	–	7.00	0.2756	200.0	250.0	7.00
A1257.0X315	–	7.00	0.2756	250.0	310.0	7.00
A1257.5X200	–	7.50	0.2953	150.0	200.0	7.50
A1257.5X250	–	7.50	0.2953	200.0	250.0	7.50
A1257.5X315	–	7.50	0.2953	250.0	310.0	7.50
A1255/16X200	5/16	7.94	0.3125	150.0	200.0	7.94
A1255/16X250	5/16	7.94	0.3125	200.0	250.0	7.94
A1255/16X315	5/16	7.94	0.3125	250.0	310.0	7.94
A1255/16X500	5/16	7.94	0.3125	400.0	460.0	7.94
A1258.0X250	–	8.00	0.3150	200.0	250.0	8.00
A1258.0X315	–	8.00	0.3150	250.0	310.0	8.00
A1258.0X400	–	8.00	0.3150	300.0	400.0	8.00
A12521/64X315	21/64	8.33	0.3281	250.0	310.0	8.33
A1258.5X250	–	8.50	0.3346	200.0	250.0	8.50
A1258.5X315	–	8.50	0.3346	250.0	310.0	8.50
A12511/32X250	11/32	8.73	0.3438	200.0	250.0	8.73
A12511/32X315	11/32	8.73	0.3438	250.0	310.0	8.73
A12511/32X400	11/32	8.73	0.3438	300.0	400.0	8.73
A12511/32X500	11/32	8.73	0.3438	400.0	460.0	8.73
A1259.0X250	–	9.00	0.3543	200.0	250.0	9.00
A1259.0X315	–	9.00	0.3543	250.0	310.0	9.00
A1259.0X400	–	9.00	0.3543	300.0	400.0	9.00
A1259.5X250	–	9.50	0.3740	200.0	250.0	9.50
A1259.5X315	–	9.50	0.3740	250.0	310.0	9.50

Product	DC	DC	DC	LCF	OAL	DCON MS
	(inch)	(mm)	(inch)	(mm)	(mm)	(mm)
A1253/8X250	3/8	9.52	0.3750	200.0	250.0	9.52
A1253/8X315	3/8	9.52	0.3750	250.0	310.0	9.52
A1253/8X400	3/8	9.52	0.3750	300.0	400.0	9.52
A1253/8X500	3/8	9.52	0.3750	400.0	460.0	9.52
A12510.0X250	–	10.00	0.3937	200.0	250.0	10.00
A12510.0X315	–	10.00	0.3937	250.0	310.0	10.00
A12510.0X400	–	10.00	0.3937	300.0	400.0	10.00
A12513/32X250	13/32	10.32	0.4063	200.0	250.0	10.32
A12513/32X315	13/32	10.32	0.4063	250.0	310.0	10.32
A12510.5X250	–	10.50	0.4134	200.0	250.0	10.50
A12510.5X315	–	10.50	0.4134	250.0	310.0	10.50
A12510.5X400	–	10.50	0.4134	300.0	400.0	10.50
A12511.0X250	–	11.00	0.4331	200.0	250.0	11.00
A12511.0X315	–	11.00	0.4331	250.0	310.0	11.00
A12511.0X400	–	11.00	0.4331	300.0	400.0	11.00
A1257/16X250	7/16	11.11	0.4375	200.0	250.0	11.11
A1257/16X315	7/16	11.11	0.4375	250.0	310.0	11.11
A1257/16X400	7/16	11.11	0.4375	300.0	400.0	11.11
A12529/64X315	29/64	11.51	0.4531	250.0	310.0	11.51
A12512.0X250	–	12.00	0.4724	200.0	250.0	12.00
A12512.0X315	–	12.00	0.4724	250.0	310.0	12.00
A12512.0X400	–	12.00	0.4724	300.0	400.0	12.00
A12531/64X315	31/64	12.30	0.4844	250.0	310.0	12.30
A1251/2X250	1/2	12.70	0.5000	200.0	250.0	12.70
A1251/2X315	1/2	12.70	0.5000	250.0	310.0	12.70
A1251/2X400	1/2	12.70	0.5000	300.0	400.0	12.70
A12513.0X315	–	13.00	0.5118	250.0	310.0	13.00
A12513.0X400	–	13.00	0.5118	300.0	400.0	13.00
A12517/32X315	17/32	13.49	0.5313	250.0	310.0	13.49
A12514.0X315	–	14.00	0.5512	250.0	310.0	14.00
A12514.0X400	–	14.00	0.5512	300.0	400.0	14.00
A1259/16X315	9/16	14.29	0.5625	250.0	310.0	14.29
A12537/64X315	37/64	14.68	0.5781	250.0	310.0	14.68
A12519/32X315	19/32	15.08	0.5938	250.0	310.0	15.08
A12519/32X500	19/32	15.08	0.5938	400.0	460.0	15.08
A1255/8X315	5/8	15.88	0.6250	250.0	310.0	15.88
A1255/8X500	5/8	15.88	0.6250	400.0	460.0	15.88
A12511/16X315	11/16	17.46	0.6875	250.0	310.0	17.46
A1253/4X315	3/4	19.05	0.7500	250.0	310.0	19.05
A1253/4X500	3/4	19.05	0.7500	400.0	460.0	19.05

Código de Material (BMC)	HSS	HSS	HSS	HSS	HSS	HSS-E	HSS-E	HSS-E	HSS-E	HSS-E		
Grupo básico estándar (BSG)	NAS 907	NAS 907	NAS 907	NAS 907	NAS 907	NAS 907	NAS 907	NAS 907	NAS 907	DIN 338		
Longitud Útil (ULDR)	2.5xD	4xD	4xD	4xD	4xD	3xD	4xD	4xD	4xD	4xD		
Ángulo de aplicación	135°	118°	135°	135°	135°	135°	135°	135°	135°	135°		
Recubrimiento	ST	ST	ST	ST	ST	Bronze	Bronze	Bronze	Bronze	Bronze		
Mango												
Forma de la Hélice	λ20-35°	λ20-35°	λ20-35°	λ20-35°	λ20-35°	λ20-35°	λ20-35°	λ20-35°	λ20-35°	λ20-35°		
Mano (dirección de corte)	R	R	R	R	R	R	R	R	R	R		

R40C R41C R42C	R10A R15A R18A	R10B R15B R18B	500-6 501-6 502-6	500-12 501-12 502-12	R88CO R89CO	R10CO R15CO R18CO	CO500-6 CO501-6	CO500-12 CO501-12	2ACO			
N60 - 1/2	1/16 - 1/2	1/16 - 1/2	N60 - 1/2	3/64 - 1/2	1/16 - 1/2	N80 - 11/16	1/16 - 1/4	1/16 - 1/4	1.00 - 13.00			
42	44	46	48	50	52	53	55	56	57			

P	P1	■	■	■	■	■	■	■	■	■		
	P2	■	■	■	■	■	■	■	■	■		
	P3	■	■	■	■	■	■	■	■	■		
	P4	■	■	■	■	■	■	■	■	■		
M	M1	■	■	■	■	■	■	■	■	■		
	M2	■	■	■	■	■	■	■	■	■		
	M3	■	■	■	■	■	■	■	■	■		
	M4	■	■	■	■	■	■	■	■	■		
K	K1	■	■	■	■	■	■	■	■	■		
	K2	■	■	■	■	■	■	■	■	■		
	K3	■	■	■	■	■	■	■	■	■		
	K4	■	■	■	■	■	■	■	■	■		
	K5	■	■	■	■	■	■	■	■	■		
N	N1	■	■	■	■	■	■	■	■	■		
	N2	■	■	■	■	■	■	■	■	■		
	N3	■	■	■	■	■	■	■	■	■		
	N4	■	■	■	■	■	■	■	■	■		
	N5	■	■	■	■	■	■	■	■	■		
S	S1	■	■	■	■	■	■	■	■	■		
	S2	■	■	■	■	■	■	■	■	■		
	S3	■	■	■	■	■	■	■	■	■		
	S4	■	■	■	■	■	■	■	■	■		
H	H1											
	H2											
	H3											
	H4											

R40C/R41C/R42C

PRECISION



NAS 907 Tipo C Broca HSS de serie extra corta, templada al vapor

Broca versátil para trabajos pesados con acabado templado al vapor. La punta hendida autocentrante de 135° reduce las fuerzas de corte y evita que la broca camine al entrar en contacto con la pieza de trabajo. El alma más gruesa y la longitud corta hacen que esta broca sea muy rígida y adecuada para taladrar a mano y a máquina muchos materiales.

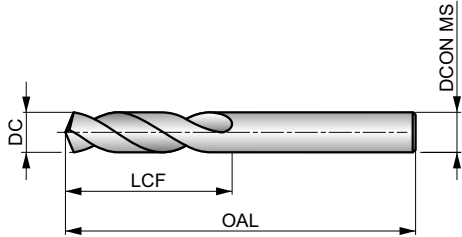

HSS	NAS 907	2.5xD
135°		
λ 20-35°		

Grupo de Material de la pieza adecuado y condiciones de velocidad de corte iniciales (m/min) y código de avance alfabético. Tablas con avance por revolución a partir de la pag.274.

P1.1 ■ 36 J	P1.2 ■ 40 J	P1.3 ■ 41 J	P2.1 ■ 31 J	P2.2 ■ 27 G	P2.3 ■ 24 F	P3.1 ■ 21 G	P3.2 ■ 17 G	P3.3 ■ 14 F	P4.1 ■ 12 G	P4.2 ■ 10 F	P4.3 ■ 9 E	M1.1 ■ 22 F	M1.2 ■ 19 F
M2.1 ■ 20 F	M2.2 ■ 16 F	M3.1 ■ 10 H	M3.2 ■ 9 H	M3.3 ■ 8 D	M4.1 ■ 10 D	K1.1 ■ 32 J	K1.2 ■ 24 G	K1.3 ■ 18 G	K2.1 ■ 25 F	K2.2 ■ 20 F	K2.3 ■ 16 F	K3.1 ■ 22 F	K3.2 ■ 17 F
K3.3 ■ 13 F	K4.1 ■ 20 F	K4.2 ■ 15 F	K4.3 ■ 11 F	K4.4 ■ 10 F	K4.5 ■ 8 F	K5.1 ■ 23 F	K5.2 ■ 17 F	K5.3 ■ 13 F	N1.1 ■ 33 K	N1.2 ■ 25 K	N1.3 ■ 17 J	N2.1 ■ 46 I	N2.2 ■ 42 I
N2.3 ■ 30 I	N3.1 ■ 64 I	N3.2 ■ 38 J	N3.3 ■ 19 H	N4.1 ■ 30 K	N4.2 ■ 35 I	N4.3 ■ 17 G	S1.1 ■ 27 G	S1.2 ■ 16 E	S1.3 ■ 8 C	S2.1 ■ 11 F	S2.2 ■ 6 B	S3.1 ■ 8 F	S3.2 ■ 4 B
S4.1 ■ 6 F	S4.2 ■ 3 B												

Product	DC (inch)	DC (Wire gauge size)	DC (Letter size)	DC (inch)	LCF (inch)	OAL (inch)	DCON MS (inch)
R41CN60 ¹⁾	-	N60	-	0.0400	0.500	1.375	0.040
R41CN59 ¹⁾	-	N59	-	0.0410	0.500	1.375	0.041
R41CN58 ¹⁾	-	N58	-	0.0420	0.500	1.375	0.042
R41CN57 ¹⁾	-	N57	-	0.0430	0.500	1.375	0.043
R41CN56 ¹⁾	-	N56	-	0.0465	0.500	1.375	0.046
R41CN55 ¹⁾	-	N55	-	0.0520	0.625	1.625	0.052
R41CN54 ¹⁾	-	N54	-	0.0550	0.625	1.625	0.055
R41CN53 ¹⁾	-	N53	-	0.0595	0.625	1.625	0.059
R40C1/16	1/16	-	-	0.0625	0.625	1.625	0.063
R41CN52	-	N52	-	0.0635	0.688	1.688	0.064
R41CN51	-	N51	-	0.0670	0.688	1.688	0.067
R41CN50	-	N50	-	0.0700	0.688	1.688	0.070
R41CN49	-	N49	-	0.0730	0.688	1.688	0.073
R41CN48	-	N48	-	0.0760	0.688	1.688	0.076
R40C5/64	5/64	-	-	0.0781	0.688	1.688	0.078
R41CN47	-	N47	-	0.0785	0.688	1.688	0.079
R41CN46	-	N46	-	0.0810	0.750	1.750	0.081
R41CN45	-	N45	-	0.0820	0.750	1.750	0.082
R41CN44	-	N44	-	0.0860	0.750	1.750	0.086
R41CN43	-	N43	-	0.0890	0.750	1.750	0.089
R41CN42	-	N42	-	0.0935	0.750	1.750	0.093
R40C3/32	3/32	-	-	0.0938	0.750	1.750	0.094
R41CN41	-	N41	-	0.0960	0.813	1.813	0.096
R41CN40	-	N40	-	0.0980	0.813	1.813	0.098

Product	DC (inch)	DC (Wire gauge size)	DC (Letter size)	DC (inch)	LCF (inch)	OAL (inch)	DCON MS (inch)
R41CN39	-	N39	-	0.0995	0.813	1.813	0.100
R41CN38	-	N38	-	0.1015	0.813	1.813	0.102
R41CN37	-	N37	-	0.1040	0.813	1.813	0.104
R41CN36	-	N36	-	0.1065	0.813	1.813	0.106
R40C7/64	7/64	-	-	0.1094	0.813	1.813	0.109
R41CN35	-	N35	-	0.1100	0.875	1.875	0.110
R41CN34	-	N34	-	0.1110	0.875	1.875	0.111
R41CN33	-	N33	-	0.1130	0.875	1.875	0.113
R41CN32	-	N32	-	0.1160	0.875	1.875	0.116
R41CN31	-	N31	-	0.1200	0.875	1.875	0.120
R40C1/8	1/8	-	-	0.1250	0.875	1.875	0.125
R41CN30	-	N30	-	0.1285	0.938	1.938	0.129
R41CN29	-	N29	-	0.1360	0.938	1.938	0.136
R41CN28	-	N28	-	0.1405	0.938	1.938	0.141
R40C9/64	9/64	-	-	0.1406	0.938	1.938	0.141
R41CN27	-	N27	-	0.1440	1.000	2.063	0.144
R41CN26	-	N26	-	0.1470	1.000	2.063	0.147
R41CN25	-	N25	-	0.1495	1.000	2.063	0.149
R41CN24	-	N24	-	0.1520	1.000	2.063	0.152
R41CN23	-	N23	-	0.1540	1.000	2.063	0.154
R40C5/32	5/32	-	-	0.1563	1.000	2.063	0.156
R41CN22	-	N22	-	0.1570	1.063	2.125	0.157
R41CN21	-	N21	-	0.1590	1.063	2.125	0.159
R41CN20	-	N20	-	0.1610	1.063	2.125	0.161



Product	DC	DC	DC	DC	LCF	OAL	DCON MS
	(inch)	(Wire gauge size)	(Letter size)	(inch)	(inch)	(inch)	(inch)
R41CN19	–	N19	–	0.1660	1.063	2.125	0.166
R41CN18	–	N18	–	0.1695	1.063	2.125	0.170
R40C11/64	11/64	–	–	0.1719	1.063	2.125	0.172
R41CN17	–	N17	–	0.1730	1.125	2.188	0.173
R41CN16	–	N16	–	0.1770	1.125	2.188	0.177
R41CN15	–	N15	–	0.1800	1.125	2.188	0.180
R41CN14	–	N14	–	0.1820	1.125	2.188	0.182
R41CN13	–	N13	–	0.1850	1.125	2.188	0.185
R40C3/16	3/16	–	–	0.1875	1.125	2.188	0.188
R41CN12	–	N12	–	0.1890	1.188	2.250	0.189
R41CN11	–	N11	–	0.1910	1.188	2.250	0.191
R41CN10	–	N10	–	0.1935	1.188	2.250	0.194
R41CN9	–	N9	–	0.1960	1.188	2.250	0.196
R41CN8	–	N8	–	0.1990	1.188	2.250	0.199
R41CN7	–	N7	–	0.2010	1.188	2.250	0.201
R40C13/64	13/64	–	–	0.2031	1.188	2.250	0.203
R41CN6	–	N6	–	0.2040	1.250	2.375	0.204
R41CN5	–	N5	–	0.2055	1.250	2.375	0.205
R41CN4	–	N4	–	0.2090	1.250	2.375	0.209
R41CN3	–	N3	–	0.2130	1.250	2.375	0.213
R40C7/32	7/32	–	–	0.2188	1.250	2.375	0.219
R41CN2	–	N2	–	0.2210	1.313	2.438	0.221
R41CN1	–	N1	–	0.2280	1.313	2.438	0.228
R42CA	–	–	A	0.2340	1.313	2.438	0.234
R40C15/64	15/64	–	–	0.2344	1.313	2.438	0.234
R42CB	–	–	B	0.2380	1.375	2.500	0.238
R42CC	–	–	C	0.2420	1.375	2.500	0.242
R42CD	–	–	D	0.2460	1.375	2.500	0.246
R40C1/4	1/4	–	–	0.2500	1.375	2.500	0.250
R42CF	–	–	F	0.2570	1.438	2.625	0.257
R42CG	–	–	G	0.2610	1.438	2.625	0.261
R40C17/64	17/64	–	–	0.2656	1.438	2.625	0.266
R42CH	–	–	H	0.2660	1.500	2.688	0.266

¹⁾ Sin punta dividida.

Product	DC	DC	DC	DC	LCF	OAL	DCON MS
	(inch)	(Wire gauge size)	(Letter size)	(inch)	(inch)	(inch)	(inch)
R42CI	–	–	I	0.2720	1.500	2.688	0.272
R42CJ	–	–	J	0.2770	1.500	2.688	0.277
R42CK	–	–	K	0.2810	1.500	2.688	0.281
R40C9/32	9/32	–	–	0.2813	1.500	2.688	0.281
R42CM	–	–	M	0.2950	1.563	2.750	0.295
R40C19/64	19/64	–	–	0.2969	1.563	2.750	0.297
R42CL	–	–	L	0.2990	1.563	2.750	0.299
R42CN	–	–	N	0.3020	1.625	2.813	0.302
R40C5/16	5/16	–	–	0.3125	1.625	2.813	0.313
R42CO	–	–	O	0.3160	1.688	2.938	0.316
R42CP	–	–	P	0.3230	1.688	2.938	0.323
R40C21/64	21/64	–	–	0.3281	1.688	2.938	0.328
R42CQ	–	–	Q	0.3320	1.688	3.000	0.332
R42CR	–	–	R	0.3390	1.688	3.000	0.339
R40C11/32	11/32	–	–	0.3438	1.688	3.000	0.344
R42CS	–	–	S	0.3480	1.750	3.063	0.348
R42CT	–	–	T	0.3580	1.750	3.063	0.358
R40C23/64	23/64	–	–	0.3594	1.750	3.063	0.359
R42CU	–	–	U	0.3680	1.813	3.125	0.368
R40C3/8	3/8	–	–	0.3750	1.813	3.125	0.375
R42CV	–	–	V	0.3770	1.875	3.250	0.377
R42CW	–	–	W	0.3860	1.875	3.250	0.386
R40C25/64	25/64	–	–	0.3906	1.875	3.250	0.391
R42CX	–	–	X	0.3970	1.938	3.313	0.397
R42CY	–	–	Y	0.4040	1.938	3.313	0.404
R40C13/32	13/32	–	–	0.4063	1.938	3.313	0.406
R42CZ	–	–	Z	0.4130	2.000	3.375	0.413
R40C27/64	27/64	–	–	0.4219	2.000	3.375	0.422
R40C7/16	7/16	–	–	0.4375	2.063	3.438	0.438
R40C29/64	29/64	–	–	0.4531	2.125	3.563	0.453
R40C15/32	15/32	–	–	0.4688	2.125	3.625	0.469
R40C31/64	31/64	–	–	0.4844	2.188	3.688	0.484
R40C1/2	1/2	–	–	0.5000	2.250	3.750	0.500

R10A/R15A/R18A

PRECISION

NAS 907 Tipo A Broca HSS de serie corta, acabado templado al vapor

Broca de muy buen rendimiento con punta dividida autocentrante de 118° para facilitar la penetración y reducir la fuerza de empuje. Acabado templado al vapor para aumentar la resistencia al desgaste y la lubricidad. Fabricada conforme a las Normas Aeroespaciales NAS 907 Tipo A.

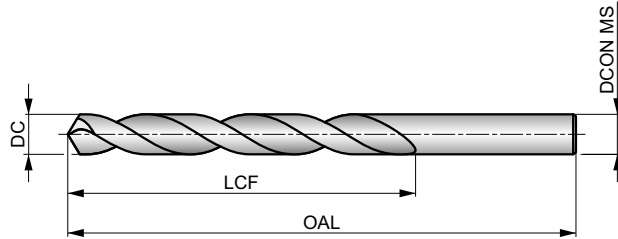

HSS	NAS 907	4xD
118°	ST	
λ 20-35°	R	

Grupo de Material de la pieza adecuado y condiciones de velocidad de corte iniciales (m/min) y código de avance alfabético. Tablas con avance por revolución a partir de la pag.274.

P1.1 ■ 36 H	P1.2 ■ 40 H	P1.3 ■ 41 H	P2.1 ■ 31 H	P2.2 ■ 27 G	P2.3 ■ 24 E	P3.1 ■ 25 F	P3.2 ■ 20 F	P3.3 ■ 17 E	P4.1 ■ 15 F	P4.2 ■ 13 E	P4.3 ■ 10 D	M1.1 ■ 30 E	M1.2 ■ 26 E
M2.1 ■ 27 E	M2.2 ■ 22 E	M2.3 ■ 18 C	M3.1 ■ 13 G	M3.2 ■ 11 G	M3.3 ■ 10 C	M4.1 ■ 15 C	M4.2 ■ 13 C	K1.1 ■ 35 H	K1.2 ■ 26 D	K1.3 ■ 19 D	K2.1 ■ 27 E	K2.2 ■ 22 E	K2.3 ■ 18 E
K3.1 ■ 24 E	K3.2 ■ 18 E	K3.3 ■ 15 E	K4.1 ■ 22 E	K4.2 ■ 17 E	K4.3 ■ 12 E	K4.4 ■ 11 E	K4.5 ■ 9 E	K5.1 ■ 25 E	K5.2 ■ 19 E	K5.3 ■ 15 E	N1.1 ■ 33 J	N1.2 ■ 25 J	N1.3 ■ 17 I
N2.1 ■ 46 H	N2.2 ■ 42 H	N2.3 ■ 30 H	N3.1 ■ 68 H	N3.2 ■ 40 F	N3.3 ■ 20 H	S1.1 ■ 28 F	S1.2 ■ 20 D	S1.3 ■ 11 C	S2.1 ■ 9 E	S2.2 ■ 8 B	S3.1 ■ 7 E	S3.2 ■ 6 B	S4.1 ■ 5 E
S4.2 ■ 5 B													

Product	DC (inch)	DC (Wire gauge size)	DC (Letter size)	DC (inch)	LCF (inch)	OAL (inch)	DCON MS (inch)
R10A1/16	1/16	-	-	0.0625	7/8	1.7/8	0.063
R18AN52	-	N52	-	0.0635	7/8	1.7/8	0.064
R18AN51	-	N51	-	0.0670	1"	2"	0.067
R18AN50	-	N50	-	0.0700	1"	2"	0.070
R18AN49	-	N49	-	0.0730	1"	2"	0.073
R18AN48	-	N48	-	0.0760	1"	2"	0.076
R10A5/64	5/64	-	-	0.0781	1"	2"	0.078
R18AN47	-	N47	-	0.0785	1"	2"	0.079
R18AN46	-	N46	-	0.0810	1.1/8	2.1/8	0.081
R18AN45	-	N45	-	0.0820	1.1/8	2.1/8	0.082
R18AN44	-	N44	-	0.0860	1.1/8	2.1/8	0.086
R18AN43	-	N43	-	0.0890	1.1/4	2.1/4	0.089
R18AN42	-	N42	-	0.0935	1.1/4	2.1/4	0.093
R10A3/32	3/32	-	-	0.0938	1.1/4	2.1/4	0.094
R18AN41	-	N41	-	0.0960	1.3/8	2.3/8	0.096
R18AN40	-	N40	-	0.0980	1.3/8	2.3/8	0.098
R18AN39	-	N39	-	0.0995	1.3/8	2.3/8	0.100
R18AN38	-	N38	-	0.1015	1.7/16	2.1/2	0.102
R18AN37	-	N37	-	0.1040	1.7/16	2.1/2	0.104
R18AN36	-	N36	-	0.1065	1.7/16	2.1/2	0.106
R10A7/64	7/64	-	-	0.1094	1.1/2	2.5/8	0.109
R18AN35	-	N35	-	0.1100	1.1/2	2.5/8	0.110
R18AN34	-	N34	-	0.1110	1.1/2	2.5/8	0.111
R18AN33	-	N33	-	0.1130	1.1/2	2.5/8	0.113

Product	DC (inch)	DC (Wire gauge size)	DC (Letter size)	DC (inch)	LCF (inch)	OAL (inch)	DCON MS (inch)
R18AN32	-	N32	-	0.1160	1.5/8	2.3/4	0.116
R18AN31	-	N31	-	0.1200	1.5/8	2.3/4	0.120
R10A1/8	1/8	-	-	0.1250	1.5/8	2.3/4	0.125
R18AN30	-	N30	-	0.1285	1.5/8	2.3/4	0.129
R18AN29	-	N29	-	0.1360	1.3/4	2.7/8	0.136
R18AN28	-	N28	-	0.1405	1.3/4	2.7/8	0.141
R10A9/64	9/64	-	-	0.1406	1.3/4	2.7/8	0.141
R18AN27	-	N27	-	0.1440	1.7/8	3"	0.144
R18AN26	-	N26	-	0.1470	1.7/8	3"	0.147
R18AN25	-	N25	-	0.1495	1.7/8	3"	0.149
R18AN24	-	N24	-	0.1520	2"	3.1/8	0.152
R18AN23	-	N23	-	0.1540	2"	3.1/8	0.154
R10A5/32	5/32	-	-	0.1563	2"	3.1/8	0.156
R18AN22	-	N22	-	0.1570	2"	3.1/8	0.157
R18AN21	-	N21	-	0.1590	2.1/8	3.1/4	0.159
R18AN20	-	N20	-	0.1610	2.1/8	3.1/4	0.161
R18AN19	-	N19	-	0.1660	2.1/8	3.1/4	0.166
R18AN18	-	N18	-	0.1695	2.1/8	3.1/4	0.170
R10A11/64	11/64	-	-	0.1719	2.1/8	3.1/4	0.172
R18AN17	-	N17	-	0.1730	2.3/16	3.3/8	0.173
R18AN16	-	N16	-	0.1770	2.3/16	3.3/8	0.177
R18AN15	-	N15	-	0.1800	2.3/16	3.3/8	0.180
R18AN14	-	N14	-	0.1820	2.3/16	3.3/8	0.182
R18AN13	-	N13	-	0.1850	2.5/16	3.1/2	0.185



Product	DC	DC	DC	DC	LCF	OAL	DCON MS
	(inch)	(Wire gauge size)	(Letter size)	(inch)	(inch)	(inch)	(inch)
R10A3/16	3/16	–	–	0.1875	2.5/16	3.1/2	0.188
R18AN12	–	N12	–	0.1890	2.5/16	3.1/2	0.189
R18AN11	–	N11	–	0.1910	2.5/16	3.1/2	0.191
R18AN10	–	N10	–	0.1935	2.7/16	3.5/8	0.194
R18AN9	–	N9	–	0.1960	2.7/16	3.5/8	0.196
R18AN8	–	N8	–	0.1990	2.7/16	3.5/8	0.199
R18AN7	–	N7	–	0.2010	2.7/16	3.5/8	0.201
R10A13/64	13/64	–	–	0.2031	2.7/16	3.5/8	0.203
R18AN6	–	N6	–	0.2040	2.1/2	3.3/4	0.204
R18AN5	–	N5	–	0.2055	2.1/2	3.3/4	0.205
R18AN4	–	N4	–	0.2090	2.1/2	3.3/4	0.209
R18AN3	–	N3	–	0.2130	2.1/2	3.3/4	0.213
R10A7/32	7/32	–	–	0.2188	2.1/2	3.3/4	0.219
R18AN2	–	N2	–	0.2210	2.5/8	3.7/8	0.221
R18AN1	–	N1	–	0.2280	2.5/8	3.7/8	0.228
R15AA	–	–	A	0.2340	2.5/8	3.7/8	0.234
R10A15/64	15/64	–	–	0.2344	2.5/8	3.7/8	0.234
R15AB	–	–	B	0.2380	2.3/4	4"	0.238
R15AC	–	–	C	0.2420	2.3/4	4"	0.242
R15AD	–	–	D	0.2460	2.3/4	4"	0.246
R10A1/4	1/4	–	–	0.2500	2.3/4	4"	0.250
R15AF	–	–	F	0.2570	2.7/8	4.1/8	0.257
R15AG	–	–	G	0.2610	2.7/8	4.1/8	0.261
R10A17/64	17/64	–	–	0.2656	2.7/8	4.1/8	0.266
R15AH	–	–	H	0.2660	2.7/8	4.1/8	0.266
R15AI	–	–	I	0.2720	2.7/8	4.1/8	0.272
R15AJ	–	–	J	0.2770	2.7/8	4.1/8	0.277
R15AK	–	–	K	0.2810	2.15/16	4.1/4	0.281
R10A9/32	9/32	–	–	0.2813	2.15/16	4.1/4	0.281

Product	DC	DC	DC	DC	LCF	OAL	DCON MS
	(inch)	(Wire gauge size)	(Letter size)	(inch)	(inch)	(inch)	(inch)
R15AL	–	–	L	0.2900	2.15/16	4.1/4	0.290
R15AM	–	–	M	0.2950	3.1/16	4.3/8	0.295
R10A19/64	19/64	–	–	0.2969	3.1/16	4.3/8	0.297
R15AN	–	–	N	0.3020	3.1/16	4.3/8	0.302
R10A5/16	5/16	–	–	0.3125	3.3/16	4.1/2	0.313
R15AO	–	–	O	0.3160	3.3/16	4.1/2	0.316
R15AP	–	–	P	0.3230	3.5/16	4.5/8	0.323
R10A21/64	21/64	–	–	0.3281	3.5/16	4.5/8	0.328
R15AQ	–	–	Q	0.3320	3.7/16	4.3/4	0.332
R15AR	–	–	R	0.3390	3.7/16	4.3/4	0.339
R10A11/32	11/32	–	–	0.3438	3.7/16	4.3/4	0.344
R15AS	–	–	S	0.3480	3.1/2	4.7/8	0.348
R15AT	–	–	T	0.3580	3.1/2	4.7/8	0.358
R10A23/64	23/64	–	–	0.3594	3.1/2	4.7/8	0.359
R15AU	–	–	U	0.3680	3.5/8	5"	0.368
R10A3/8	3/8	–	–	0.3750	3.5/8	5"	0.375
R15AV	–	–	V	0.3770	3.5/8	5"	0.377
R15AW	–	–	W	0.3860	3.3/4	5.1/8	0.386
R10A25/64	25/64	–	–	0.3906	3.3/4	5.1/8	0.391
R15AX	–	–	X	0.3970	3.3/4	5.1/8	0.397
R15AY	–	–	Y	0.4040	3.7/8	5.1/4	0.404
R10A13/32	13/32	–	–	0.4063	3.7/8	5.1/4	0.406
R15AZ	–	–	Z	0.4130	3.7/8	5.1/4	0.413
R10A27/64	27/64	–	–	0.4219	3.15/16	5.3/8	0.422
R10A7/16	7/16	–	–	0.4375	4.1/16	5.1/2	0.438
R10A29/64	29/64	–	–	0.4531	4.3/16	5.5/8	0.453
R10A15/32	15/32	–	–	0.4688	4.5/16	5.3/4	0.469
R10A31/64	31/64	–	–	0.4844	4.3/8	5.7/8	0.484
R10A1/2	1/2	–	–	0.5000	4.1/2	6"	0.500

R10B/R15B/R18B

PRECISION



NAS 907 Tipo B Broca HSS de serie corta, templada al vapor

Broca para trabajos pesados con punta dividida autocentrante de 135° de baja fuerza de empuje para facilitar la penetración. Acabado templado al vapor para aumentar la resistencia al desgaste y la lubricidad. Fabricada según las Normas Aeroespaciales NAS 907 Tipo B.

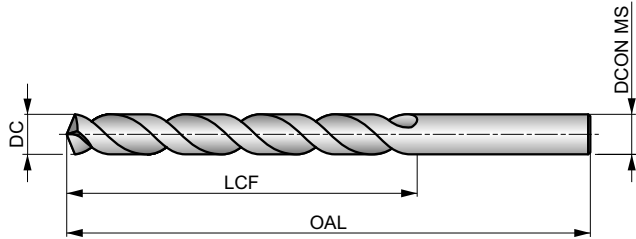

HSS	NAS 907	4xD
135°	ST	
λ 20-35°	R	

Grupo de Material de la pieza adecuado y condiciones de velocidad de corte iniciales (m/min) y código de avance alfabético. Tablas con avance por revolución a partir de la pag.274.

P1.1 36 H	P1.2 40 H	P1.3 41 H	P2.1 31 H	P2.2 27 G	P2.3 24 E	P3.1 25 F	P3.2 20 F	P3.3 17 E	P4.1 15 F	P4.2 13 E	P4.3 10 D	M1.1 30 E	M1.2 26 E
M2.1 27 E	M2.2 22 E	M2.3 18 C	M3.1 13 G	M3.2 11 G	M3.3 10 C	M4.1 15 C	M4.2 13 C	K1.1 35 H	K1.2 26 D	K1.3 19 D	K2.1 27 E	K2.2 22 E	K2.3 18 E
K3.1 24 E	K3.2 18 E	K3.3 15 E	K4.1 22 E	K4.2 17 E	K4.3 12 E	K4.4 11 E	K4.5 9 E	K5.1 25 E	K5.2 19 E	K5.3 15 E	N1.1 33 J	N1.2 25 J	N1.3 17 I
N2.1 46 H	N2.2 42 H	N2.3 30 H	N3.1 68 H	N3.2 40 F	N3.3 20 H	S1.1 28 F	S1.2 20 D	S1.3 11 C	S2.1 9 E	S2.2 8 B	S3.1 7 E	S3.2 6 B	S4.1 5 E
S4.2 5 B													

Product	DC (inch)	DC (Wire gauge size)	DC (Letter size)	DC (inch)	LCF (inch)	OAL (inch)	DCON MS (inch)
R10B1/16	1/16	-	-	0.0625	7/8	1.7/8	0.063
R18BN52	-	N52	-	0.0635	7/8	1.7/8	0.064
R18BN51	-	N51	-	0.0670	1"	2"	0.067
R18BN50	-	N50	-	0.0700	1"	2"	0.070
R18BN49	-	N49	-	0.0730	1"	2"	0.073
R18BN48	-	N48	-	0.0760	1"	2"	0.076
R10B5/64	5/64	-	-	0.0781	1"	2"	0.078
R18BN47	-	N47	-	0.0785	1"	2"	0.079
R18BN46	-	N46	-	0.0810	1.1/8	2.1/8	0.081
R18BN45	-	N45	-	0.0820	1.1/8	2.1/8	0.082
R18BN44	-	N44	-	0.0860	1.1/8	2.1/8	0.086
R18BN43	-	N43	-	0.0890	1.1/4	2.1/4	0.089
R18BN42	-	N42	-	0.0935	1.1/4	2.1/4	0.093
R10B3/32	3/32	-	-	0.0938	1.1/4	2.1/4	0.094
R18BN41	-	N41	-	0.0960	1.3/8	2.3/8	0.096
R18BN40	-	N40	-	0.0980	1.3/8	2.3/8	0.098
R18BN39	-	N39	-	0.0995	1.3/8	2.3/8	0.100
R18BN38	-	N38	-	0.1015	1.7/16	2.1/2	0.102
R18BN37	-	N37	-	0.1040	1.7/16	2.1/2	0.104
R18BN36	-	N36	-	0.1065	1.7/16	2.1/2	0.106
R10B7/64	7/64	-	-	0.1094	1.1/2	2.5/8	0.109
R18BN35	-	N35	-	0.1100	1.1/2	2.5/8	0.110
R18BN34	-	N34	-	0.1110	1.1/2	2.5/8	0.111
R18BN33	-	N33	-	0.1130	1.1/2	2.5/8	0.113

Product	DC (inch)	DC (Wire gauge size)	DC (Letter size)	DC (inch)	LCF (inch)	OAL (inch)	DCON MS (inch)
R18BN32	-	N32	-	0.1160	1.5/8	2.3/4	0.116
R18BN31	-	N31	-	0.1200	1.5/8	2.3/4	0.120
R10B1/8	1/8	-	-	0.1250	1.5/8	2.3/4	0.125
R18BN30	-	N30	-	0.1285	1.5/8	2.3/4	0.129
R18BN29	-	N29	-	0.1360	1.3/4	2.7/8	0.136
R18BN28	-	N28	-	0.1405	1.3/4	2.7/8	0.141
R10B9/64	9/64	-	-	0.1406	1.3/4	2.7/8	0.141
R18BN27	-	N27	-	0.1440	1.7/8	3"	0.144
R18BN26	-	N26	-	0.1470	1.7/8	3"	0.147
R18BN25	-	N25	-	0.1495	1.7/8	3"	0.149
R18BN24	-	N24	-	0.1520	2"	3.1/8	0.152
R18BN23	-	N23	-	0.1540	2"	3.1/8	0.154
R10B5/32	5/32	-	-	0.1563	2"	3.1/8	0.156
R18BN22	-	N22	-	0.1570	2"	3.1/8	0.157
R18BN21	-	N21	-	0.1590	2.1/8	3.1/4	0.159
R18BN20	-	N20	-	0.1610	2.1/8	3.1/4	0.161
R18BN19	-	N19	-	0.1660	2.1/8	3.1/4	0.166
R18BN18	-	N18	-	0.1695	2.1/8	3.1/4	0.170
R10B11/64	11/64	-	-	0.1719	2.1/8	3.1/4	0.172
R18BN17	-	N17	-	0.1730	2.3/16	3.3/8	0.173
R18BN16	-	N16	-	0.1770	2.3/16	3.3/8	0.177
R18BN15	-	N15	-	0.1800	2.3/16	3.3/8	0.180
R18BN14	-	N14	-	0.1820	2.3/16	3.3/8	0.182
R18BN13	-	N13	-	0.1850	2.5/16	3.1/2	0.185



Product	DC	DC	DC	DC	LCF	OAL	DCON
	(inch)	(Wire gauge size)	(Letter size)	(inch)	(inch)	(inch)	(inch)
R10B3/16	3/16	–	–	0.1875	2.5/16	3.1/2	0.188
R18BN12	–	N12	–	0.1890	2.5/16	3.1/2	0.189
R18BN11	–	N11	–	0.1910	2.5/16	3.1/2	0.191
R18BN10	–	N10	–	0.1935	2.7/16	3.5/8	0.194
R18BN9	–	N9	–	0.1960	2.7/16	3.5/8	0.196
R18BN8	–	N8	–	0.1990	2.7/16	3.5/8	0.199
R18BN7	–	N7	–	0.2010	2.7/16	3.5/8	0.201
R10B13/64	13/64	–	–	0.2031	2.7/16	3.5/8	0.203
R18BN6	–	N6	–	0.2040	2.1/2	3.3/4	0.204
R18BN5	–	N5	–	0.2055	2.1/2	3.3/4	0.205
R18BN4	–	N4	–	0.2090	2.1/2	3.3/4	0.209
R18BN3	–	N3	–	0.2130	2.1/2	3.3/4	0.213
R10B7/32	7/32	–	–	0.2188	2.1/2	3.3/4	0.219
R18BN2	–	N2	–	0.2210	2.5/8	3.7/8	0.221
R18BN1	–	N1	–	0.2280	2.5/8	3.7/8	0.228
R15BA	–	–	A	0.2340	2.5/8	3.7/8	0.234
R10B15/64	15/64	–	–	0.2344	2.5/8	3.7/8	0.234
R15BB	–	–	B	0.2380	2.3/4	4"	0.238
R15BC	–	–	C	0.2420	2.3/4	4"	0.242
R15BD	–	–	D	0.2460	2.3/4	4"	0.246
R10B1/4	1/4	–	–	0.2500	2.3/4	4"	0.250
R15BF	–	–	F	0.2570	2.7/8	4.1/8	0.257
R15BG	–	–	G	0.2610	2.7/8	4.1/8	0.261
R10B17/64	17/64	–	–	0.2656	2.7/8	4.1/8	0.266
R15BH	–	–	H	0.2660	2.7/8	4.1/8	0.266
R15BI	–	–	I	0.2720	2.7/8	4.1/8	0.272
R15BJ	–	–	J	0.2770	2.7/8	4.1/8	0.277
R15BK	–	–	K	0.2810	2.15/16	4.1/4	0.281
R10B9/32	9/32	–	–	0.2813	2.15/16	4.1/4	0.281

Product	DC	DC	DC	DC	LCF	OAL	DCON
	(inch)	(Wire gauge size)	(Letter size)	(inch)	(inch)	(inch)	(inch)
R15BL	–	–	L	0.2900	2.15/16	4.1/4	0.290
R15BM	–	–	M	0.2950	3.1/16	4.3/8	0.295
R10B19/64	19/64	–	–	0.2969	3.1/16	4.3/8	0.297
R15BN	–	–	N	0.3020	3.1/16	4.3/8	0.302
R10B5/16	5/16	–	–	0.3125	3.3/16	4.1/2	0.313
R15B0	–	–	O	0.3160	3.3/16	4.1/2	0.316
R15BP	–	–	P	0.3230	3.5/16	4.5/8	0.323
R10B21/64	21/64	–	–	0.3281	3.5/16	4.5/8	0.328
R15BQ	–	–	Q	0.3320	3.7/16	4.3/4	0.332
R15BR	–	–	R	0.3390	3.7/16	4.3/4	0.339
R10B11/32	11/32	–	–	0.3438	3.7/16	4.3/4	0.344
R15BS	–	–	S	0.3480	3.1/2	4.7/8	0.348
R15BT	–	–	T	0.3580	3.1/2	4.7/8	0.358
R10B23/64	23/64	–	–	0.3594	3.1/2	4.7/8	0.359
R15BU	–	–	U	0.3680	3.5/8	5"	0.368
R10B3/8	3/8	–	–	0.3750	3.5/8	5"	0.375
R15BV	–	–	V	0.3770	3.5/8	5"	0.377
R15BW	–	–	W	0.3860	3.3/4	5.1/8	0.386
R10B25/64	25/64	–	–	0.3906	3.3/4	5.1/8	0.391
R15BX	–	–	X	0.3970	3.3/4	5.1/8	0.397
R15BY	–	–	Y	0.4040	3.7/8	5.1/4	0.404
R10B13/32	13/32	–	–	0.4063	3.7/8	5.1/4	0.406
R15BZ	–	–	Z	0.4130	3.7/8	5.1/4	0.413
R10B27/64	27/64	–	–	0.4219	3.15/16	5.3/8	0.422
R10B7/16	7/16	–	–	0.4375	4.1/16	5.1/2	0.438
R10B29/64	29/64	–	–	0.4531	4.3/16	5.5/8	0.453
R10B15/32	15/32	–	–	0.4688	4.5/16	5.3/4	0.469
R10B31/64	31/64	–	–	0.4844	4.3/8	5.7/8	0.484
R10B1/2	1/2	–	–	0.5000	4.1/2	6"	0.500

500-6/501-6/502-6

PRECISION



NAS 907 Tipo B Broca HSS extralarga para aeronaves, 6" OAL

Las brocas de serie larga, fabricadas según las Normas Aeroespaciales Nacionales, con una longitud total larga en combinación con una longitud de estría corta, son ideales para taladrar en zonas de difícil acceso. La punta dividida autocentrante de 135° y el acabado superficial templado al vapor las hacen adecuadas para taladrar la mayoría de los materiales.

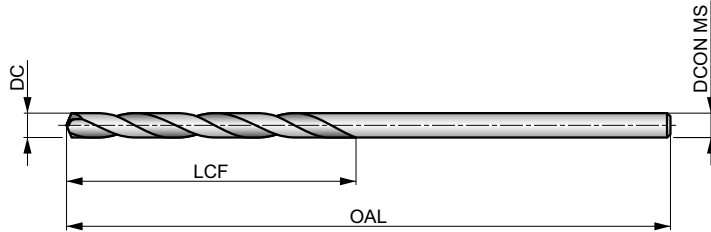

HSS	NAS 907	4xD
135°	ST	
λ 20-35°	R	

Grupo de Material de la pieza adecuado y condiciones de velocidad de corte iniciales (m/min) y código de avance alfabético. Tablas con avance por revolución a partir de la pag.274.

P2.2 ■ 25 F	P2.3 ■ 22 E	P3.1 ■ 19 F	P3.2 ■ 15 F	P3.3 ■ 13 E	P4.1 ■ 11 F	P4.2 ■ 10 E	P4.3 ■ 8 D	M1.1 ■ 21 E	M1.2 ■ 17 E	M2.1 ■ 18 E	M2.2 ■ 15 E	M3.1 ■ 9 G	M3.2 ■ 8 G
M3.3 ■ 7 C	M4.1 ■ 9 C	K1.1 ■ 30 I	K1.2 ■ 22 F	K1.3 ■ 17 F	K2.1 ■ 25 E	K2.2 ■ 20 E	K2.3 ■ 16 E	K3.1 ■ 22 E	K3.2 ■ 17 E	K3.3 ■ 13 E	K4.1 ■ 20 E	K4.2 ■ 15 E	K4.3 ■ 11 E
K4.4 ■ 10 E	K4.5 ■ 8 E	K5.1 ■ 23 E	K5.2 ■ 17 E	K5.3 ■ 13 E	N2.2 ■ 27 G	N2.3 ■ 24 F	N3.1 ■ 27 H	N3.2 ■ 21 H	N3.3 ■ 16 G	S1.1 ■ 23 F	S1.2 ■ 12 D	S1.3 ■ 6 B	S2.1 ■ 8 E
S2.2 ■ 4 A	S3.1 ■ 16 E	S3.2 ■ 3 A	S4.1 ■ 5 E	S4.2 ■ 2 A									

Product	DC (inch)	DC (Wire gauge size)	DC (Letter size)	DC (inch)	LCF (inch)	OAL (inch)	DCON MS (inch)
501-6N60 ¹⁾	-	N60	-	0.0400	11/16	6"	0.040
501-6N59 ¹⁾	-	N59	-	0.0410	11/16	6"	0.041
501-6N58 ¹⁾	-	N58	-	0.0420	11/16	6"	0.042
501-6N57 ¹⁾	-	N57	-	0.0430	3/4	6"	0.043
501-6N56 ¹⁾	-	N56	-	0.0465	3/4	6"	0.046
500-63/64 ¹⁾	3/64	-	-	0.0469	3/4	6"	0.047
501-6N55 ¹⁾	-	N55	-	0.0520	7/8	6"	0.052
501-6N54 ¹⁾	-	N54	-	0.0550	7/8	6"	0.055
501-6N53 ¹⁾	-	N53	-	0.0595	7/8	6"	0.059
500-61/16	1/16	-	-	0.0625	7/8	6"	0.063
501-6N52	-	N52	-	0.0635	7/8	6"	0.064
501-6N51	-	N51	-	0.0670	1"	6"	0.067
501-6N50	-	N50	-	0.0700	1"	6"	0.070
501-6N49	-	N49	-	0.0730	1"	6"	0.073
501-6N48	-	N48	-	0.0760	1"	6"	0.076
500-65/64	5/64	-	-	0.0781	1"	6"	0.078
501-6N47	-	N47	-	0.0785	1"	6"	0.079
501-6N46	-	N46	-	0.0810	1.1/8	6"	0.081
501-6N45	-	N45	-	0.0820	1.1/8	6"	0.082
501-6N44	-	N44	-	0.0860	1.1/8	6"	0.086
501-6N43	-	N43	-	0.0890	1.1/4	6"	0.089
501-6N42	-	N42	-	0.0935	1.1/4	6"	0.093
500-63/32	3/32	-	-	0.0938	1.1/4	6"	0.094
501-6N41	-	N41	-	0.0960	1.3/8	6"	0.096
501-6N40	-	N40	-	0.0980	1.3/8	6"	0.098
501-6N39	-	N39	-	0.0995	1.3/8	6"	0.100

Product	DC (inch)	DC (Wire gauge size)	DC (Letter size)	DC (inch)	LCF (inch)	OAL (inch)	DCON MS (inch)
501-6N38	-	N38	-	0.1015	1.7/16	6"	0.102
501-6N37	-	N37	-	0.1040	1.7/16	6"	0.104
501-6N36	-	N36	-	0.1065	1.7/16	6"	0.106
500-67/64	7/64	-	-	0.1094	1.1/2	6"	0.109
501-6N35	-	N35	-	0.1100	1.1/2	6"	0.110
501-6N34	-	N34	-	0.1110	1.1/2	6"	0.111
501-6N33	-	N33	-	0.1130	1.1/2	6"	0.113
501-6N32	-	N32	-	0.1160	1.5/8	6"	0.116
501-6N31	-	N31	-	0.1200	1.5/8	6"	0.120
500-61/8	1/8	-	-	0.1250	1.5/8	6"	0.125
501-6N30	-	N30	-	0.1285	1.5/8	6"	0.129
501-6N29	-	N29	-	0.1360	1.3/4	6"	0.136
501-6N28	-	N28	-	0.1405	1.3/4	6"	0.141
500-69/64	9/64	-	-	0.1406	1.3/4	6"	0.141
501-6N27	-	N27	-	0.1440	1.7/8	6"	0.144
501-6N26	-	N26	-	0.1470	1.7/8	6"	0.147
501-6N25	-	N25	-	0.1495	1.7/8	6"	0.149
501-6N24	-	N24	-	0.1520	2"	6"	0.152
501-6N23	-	N23	-	0.1540	2"	6"	0.154
500-65/32	5/32	-	-	0.1563	2"	6"	0.156
501-6N22	-	N22	-	0.1570	2"	6"	0.157
501-6N21	-	N21	-	0.1590	2.1/8	6"	0.159
501-6N20	-	N20	-	0.1610	2.1/8	6"	0.161
501-6N19	-	N19	-	0.1660	2.1/8	6"	0.166
501-6N18	-	N18	-	0.1695	2.1/8	6"	0.170
500-611/64	11/64	-	-	0.1719	2.1/8	6"	0.172



Product	DC	DC	DC	DC	LCF	OAL	DCON
	(inch)	(Wire gauge size)	(Letter size)	(inch)	(inch)	(inch)	(inch)
501-6N17	–	N17	–	0.1730	2.3/16	6"	0.173
501-6N16	–	N16	–	0.1770	2.3/16	6"	0.177
501-6N15	–	N15	–	0.1800	2.3/16	6"	0.180
501-6N14	–	N14	–	0.1820	2.3/16	6"	0.182
501-6N13	–	N13	–	0.1850	2.5/16	6"	0.185
500-63/16	3/16	–	–	0.1875	2.5/16	6"	0.188
501-6N12	–	N12	–	0.1890	2.5/16	6"	0.189
501-6N11	–	N11	–	0.1910	2.5/16	6"	0.191
501-6N10	–	N10	–	0.1935	2.7/16	6"	0.194
501-6N9	–	N9	–	0.1960	2.7/16	6"	0.196
501-6N8	–	N8	–	0.1990	2.7/16	6"	0.199
501-6N7	–	N7	–	0.2010	2.7/16	6"	0.201
500-613/64	13/64	–	–	0.2031	2.7/16	6"	0.203
501-6N6	–	N6	–	0.2040	2.1/2	6"	0.204
501-6N5	–	N5	–	0.2055	2.1/2	6"	0.205
501-6N4	–	N4	–	0.2090	2.1/2	6"	0.209
501-6N3	–	N3	–	0.2130	2.1/2	6"	0.213
500-67/32	7/32	–	–	0.2188	2.1/2	6"	0.219
501-6N2	–	N2	–	0.2210	2.5/8	6"	0.221
501-6N1	–	N1	–	0.2280	2.5/8	6"	0.228
502-6A	–	–	A	0.2340	2.5/8	6"	0.234
500-615/64	15/64	–	–	0.2344	2.5/8	6"	0.234
502-6B	–	–	B	0.2380	2.3/4	6"	0.238
502-6C	–	–	C	0.2420	2.3/4	6"	0.242
502-6D	–	–	D	0.2460	2.3/4	6"	0.246
500-61/4	1/4	–	–	0.2500	2.3/4	6"	0.250
502-6F	–	–	F	0.2570	2.7/8	6"	0.257
502-6G	–	–	G	0.2610	2.7/8	6"	0.261
500-617/64	17/64	–	–	0.2656	2.7/8	6"	0.266
502-6H	–	–	H	0.2660	2.7/8	6"	0.266
502-6I	–	–	I	0.2720	2.7/8	6"	0.272
502-6J	–	–	J	0.2770	2.7/8	6"	0.277

¹⁾ Sin punta dividida.

Product	DC	DC	DC	DC	LCF	OAL	DCON
	(inch)	(Wire gauge size)	(Letter size)	(inch)	(inch)	(inch)	(inch)
502-6K	–	–	K	0.2810	2.15/16	6"	0.281
500-69/32	9/32	–	–	0.2813	2.15/16	6"	0.281
502-6L	–	–	L	0.2900	2.15/16	6"	0.290
502-6M	–	–	M	0.2950	3.1/16	6"	0.295
500-619/64	19/64	–	–	0.2969	3.1/16	6"	0.297
502-6N	–	–	N	0.3020	3.1/16	6"	0.302
500-65/16	5/16	–	–	0.3125	3.3/16	6"	0.313
502-6O	–	–	O	0.3160	3.3/16	6"	0.316
502-6P	–	–	P	0.3230	3.5/16	6"	0.323
500-621/64	21/64	–	–	0.3281	3.5/16	6"	0.328
502-6Q	–	–	Q	0.3320	3.7/16	6"	0.332
502-6R	–	–	R	0.3390	3.7/16	6"	0.339
500-611/32	11/32	–	–	0.3438	3.7/16	6"	0.344
502-6S	–	–	S	0.3480	3.1/2	6"	0.348
502-6T	–	–	T	0.3580	3.1/2	6"	0.358
500-623/64	23/64	–	–	0.3594	3.1/2	6"	0.359
502-6U	–	–	U	0.3680	3.5/8	6"	0.368
500-63/8	3/8	–	–	0.3750	3.5/8	6"	0.375
502-6V	–	–	V	0.3772	3.5/8	6"	0.377
502-6W	–	–	W	0.3860	3.3/4	6"	0.386
500-625/64	25/64	–	–	0.3906	3.3/4	6"	0.391
502-6X	–	–	X	0.3970	3.3/4	6"	0.397
502-6Y	–	–	Y	0.4040	3.7/8	6"	0.404
500-613/32	13/32	–	–	0.4063	3.7/8	6"	0.406
502-6Z	–	–	Z	0.4130	3.7/8	6"	0.413
500-627/64	27/64	–	–	0.4219	3.15/16	6"	0.422
500-67/16	7/16	–	–	0.4375	4.1/16	6"	0.438
500-629/64	29/64	–	–	0.4531	4.3/16	6"	0.453
500-615/32	15/32	–	–	0.4688	4.5/16	6"	0.469
500-631/64	31/64	–	–	0.4844	4.3/8	6"	0.484
500-61/2	1/2	–	–	0.5000	4.1/2	6"	0.500

500-12/501-12/502-12

PRECISION

NAS 907 Tipo B Broca HSS extralarga para aeronaves, 12" OAL

Las brocas de la serie extralarga, fabricadas según las Normas Aeroespaciales Nacionales, con una longitud total extralarga combinada con una longitud de estria corta, son ideales para taladrar en zonas de difícil acceso. La punta dividida autocentrante de 135° y el acabado superficial templado al vapor la hacen adecuada para taladrar la mayoría de los materiales.

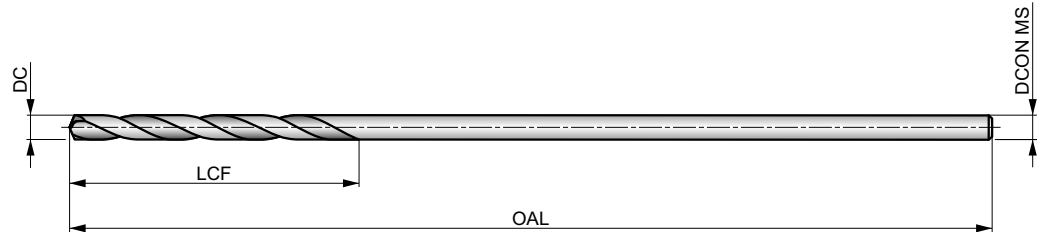

HSS	NAS 907	4xD
135°	ST	
λ 20-35°	R	

Grupo de Material de la pieza adecuado y condiciones de velocidad de corte iniciales (m/min) y código de avance alfabético. Tablas con avance por revolución a partir de la pag.274.

P2.2 ■ 25 F	P2.3 ■ 22 E	P3.1 ■ 19 F	P3.2 ■ 15 F	P3.3 ■ 13 E	P4.1 ■ 11 F	P4.2 ■ 10 E	P4.3 ■ 8 D	M1.1 ■ 21 E	M1.2 ■ 17 E	M2.1 ■ 18 E	M2.2 ■ 15 E	M3.1 ■ 9 G	M3.2 ■ 8 G
M3.3 ■ 7 C	M4.1 ■ 9 C	K1.1 ■ 30 I	K1.2 ■ 22 F	K1.3 ■ 17 F	K2.1 ■ 25 E	K2.2 ■ 20 E	K2.3 ■ 16 E	K3.1 ■ 22 E	K3.2 ■ 17 E	K3.3 ■ 13 E	K4.1 ■ 20 E	K4.2 ■ 15 E	K4.3 ■ 11 E
K4.4 ■ 10 E	K4.5 ■ 8 E	K5.1 ■ 23 E	K5.2 ■ 17 E	K5.3 ■ 13 E	N2.2 ■ 27 G	N2.3 ■ 24 F	N3.1 ■ 27 H	N3.2 ■ 21 H	N3.3 ■ 16 G	S1.1 ■ 23 F	S1.2 ■ 12 D	S1.3 ■ 6 B	S2.1 ■ 8 E
S2.2 ■ 4 A	S3.1 ■ 16 E	S3.2 ■ 3 A	S4.1 ■ 5 E	S4.2 ■ 2 A									

Product	DC	DC	DC	DC	LCF	OAL	DCON MS
	(inch)	(Wire gauge size)	(Letter size)	(inch)	(inch)	(inch)	(inch)
500-123/64	3/64	-	-	0.0469	3/4	12"	0.047
500-121/16	1/16	-	-	0.0625	7/8	12"	0.063
501-12N50	-	N50	-	0.0700	1"	12"	0.070
501-12N49	-	N49	-	0.0730	1"	12"	0.073
500-125/64	5/64	-	-	0.0781	1"	12"	0.078
501-12N47	-	N47	-	0.0785	1"	12"	0.079
501-12N46	-	N46	-	0.0810	1.1/8	12"	0.081
501-12N45	-	N45	-	0.0820	1.1/8	12"	0.082
501-12N44	-	N44	-	0.0860	1.1/8	12"	0.086
501-12N43	-	N43	-	0.0890	1.1/4	12"	0.089
501-12N42	-	N42	-	0.0935	1.1/4	12"	0.093
500-123/32	3/32	-	-	0.0938	1.1/4	12"	0.094
501-12N41	-	N41	-	0.0960	1.3/8	12"	0.096
501-12N40	-	N40	-	0.0980	1.3/8	12"	0.098
501-12N37	-	N37	-	0.1040	1.7/16	12"	0.104
501-12N36	-	N36	-	0.1065	1.7/16	12"	0.106
500-127/64	7/64	-	-	0.1094	1.1/2	12"	0.109
501-12N31	-	N31	-	0.1200	1.5/8	12"	0.120
500-121/8	1/8	-	-	0.1250	1.5/8	12"	0.125
501-12N30	-	N30	-	0.1285	1.5/8	12"	0.129
501-12N29	-	N29	-	0.1360	1.3/4	12"	0.136
500-129/64	9/64	-	-	0.1406	1.3/4	12"	0.141
501-12N27	-	N27	-	0.1440	1.7/8	12"	0.144
501-12N26	-	N26	-	0.1470	1.7/8	12"	0.147
501-12N25	-	N25	-	0.1495	1.7/8	12"	0.149
501-12N23	-	N23	-	0.1540	2"	12"	0.154

Product	DC	DC	DC	DC	LCF	OAL	DCON MS
	(inch)	(Wire gauge size)	(Letter size)	(inch)	(inch)	(inch)	(inch)
500-125/32	5/32	-	-	0.1563	2"	12"	0.156
501-12N22	-	N22	-	0.1570	2"	12"	0.157
501-12N21	-	N21	-	0.1590	2.1/8	12"	0.159
501-12N20	-	N20	-	0.1610	2.1/8	12"	0.161
501-12N19	-	N19	-	0.1660	2.1/8	12"	0.166
501-12N18	-	N18	-	0.1695	2.1/8	12"	0.170
500-1211/64	11/64	-	-	0.1719	2.1/8	12"	0.172
501-12N17	-	N17	-	0.1730	2.3/16	12"	0.173
501-12N16	-	N16	-	0.1770	2.3/16	12"	0.177
501-12N13	-	N13	-	0.1850	2.5/16	12"	0.185
500-123/16	3/16	-	-	0.1875	2.5/16	12"	0.188
501-12N12	-	N12	-	0.1890	2.5/16	12"	0.189
501-12N11	-	N11	-	0.1910	2.5/16	12"	0.191
501-12N10	-	N10	-	0.1935	2.7/16	12"	0.194
501-12N9	-	N9	-	0.1960	2.7/16	12"	0.196
501-12N7	-	N7	-	0.2010	2.7/16	12"	0.201
500-1213/64	13/64	-	-	0.2031	2.7/16	12"	0.203
501-12N5	-	N5	-	0.2055	2.1/2	12"	0.205
501-12N4	-	N4	-	0.2090	2.1/2	12"	0.209
501-12N3	-	N3	-	0.2130	2.1/2	12"	0.213
500-127/32	7/32	-	-	0.2188	2.1/2	12"	0.219
501-12N1	-	N1	-	0.2280	2.5/8	12"	0.228
502-12A	-	-	A	0.2340	2.5/8	12"	0.234
500-1215/64	15/64	-	-	0.2344	2.5/8	12"	0.234
502-12B	-	-	B	0.2380	2.3/4	12"	0.238
502-12C	-	-	C	0.2420	2.3/4	12"	0.242



Product	DC	DC	DC	DC	LCF	OAL	DCON MS
	(inch)	(Wire gauge size)	(Letter size)	(inch)	(inch)	(inch)	(inch)
502-12D	–	–	D	0.2460	2.3/4	12"	0.246
500-121/4	1/4	–	–	0.2500	2.3/4	12"	0.250
502-12F	–	–	F	0.2570	2.7/8	12"	0.257
502-12G	–	–	G	0.2610	2.7/8	12"	0.261
500-1217/64	17/64	–	–	0.2656	2.7/8	12"	0.266
502-12H	–	–	H	0.2660	2.7/8	12"	0.266
502-12I	–	–	I	0.2720	2.7/8	12"	0.272
502-12J	–	–	J	0.2770	2.7/8	12"	0.277
502-12K	–	–	K	0.2810	2.15/16	12"	0.281
500-129/32	9/32	–	–	0.2813	2.15/16	12"	0.281
502-12L	–	–	L	0.2900	2.15/16	12"	0.290
502-12M	–	–	M	0.2950	3.1/16	12"	0.295
500-1219/64	19/64	–	–	0.2969	3.1/16	12"	0.297
502-12N	–	–	N	0.3020	3.1/16	12"	0.302
500-125/16	5/16	–	–	0.3125	3.3/16	12"	0.313
502-12O	–	–	O	0.3160	3.3/16	12"	0.316
502-12P	–	–	P	0.3230	3.5/16	12"	0.323
500-1221/64	21/64	–	–	0.3281	3.5/16	12"	0.328
502-12Q	–	–	Q	0.3320	3.7/16	12"	0.332
502-12R	–	–	R	0.3390	3.7/16	12"	0.339

Product	DC	DC	DC	DC	LCF	OAL	DCON MS
	(inch)	(Wire gauge size)	(Letter size)	(inch)	(inch)	(inch)	(inch)
500-1211/32	11/32	–	–	0.3438	3.7/16	12"	0.344
502-12S	–	–	S	0.3480	3.1/2	12"	0.348
502-12T	–	–	T	0.3580	3.1/2	12"	0.358
500-1223/64	23/64	–	–	0.3594	3.1/2	12"	0.359
502-12U	–	–	U	0.3680	3.5/8	12"	0.368
500-123/8	3/8	–	–	0.3750	3.5/8	12"	0.375
502-12V	–	–	V	0.3770	3.5/8	12"	0.377
502-12W	–	–	W	0.3860	3.3/4	12"	0.386
500-1225/64	25/64	–	–	0.3906	3.3/4	12"	0.391
502-12X	–	–	X	0.3970	3.3/4	12"	0.397
502-12Y	–	–	Y	0.4040	3.7/8	12"	0.404
500-1213/32	13/32	–	–	0.4063	3.7/8	12"	0.406
502-12Z	–	–	Z	0.4130	3.7/8	12"	0.413
500-1227/64	27/64	–	–	0.4219	3.15/16	12"	0.422
500-127/16	7/16	–	–	0.4375	4.1/16	12"	0.438
500-1229/64	29/64	–	–	0.4531	4.3/16	12"	0.453
500-1215/32	15/32	–	–	0.4688	4.5/16	12"	0.469
500-1231/64	31/64	–	–	0.4844	4.3/8	12"	0.484
500-121/2	1/2	–	–	0.5000	4.1/2	12"	0.500

R88CO/R89CO

PRECISION

NAS 907 Tipo D Broca HSS-E (8%) Cobalto de serie corta para trabajos pesados

Una broca de serie corta con una longitud de filos más corta y un mango más largo para una mayor rigidez. Excelente broca cuando se necesita más alcance para taladrar agujeros poco profundos o materiales más finos. Acabado superficial de bronce templado con punta dividida autocentrante de 135° de baja fuerza de empuje para facilitar la penetración. Fabricada según las Normas Aeroespaciales NAS 907 Tipo D.

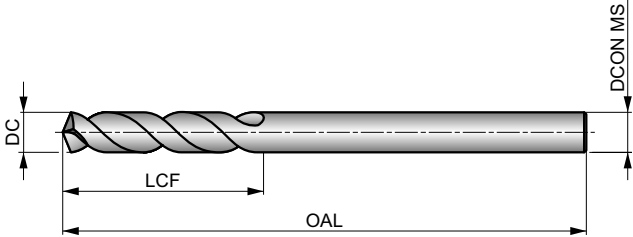

HSS-E	NAS 907	3xD
135°	Bronze	
λ20-35°		

Grupo de Material de la pieza adecuado y condiciones de velocidad de corte iniciales (m/min) y código de avance alfabético. Tablas con avance por revolución a partir de la pag.274.

P1.1 ■ 36 H	P1.2 ■ 40 H	P1.3 ■ 41 H	P2.1 ■ 31 H	P2.2 ■ 27 G	P2.3 ■ 24 E	P3.1 ■ 25 F	P3.2 ■ 20 F	P3.3 ■ 17 E	P4.1 ■ 15 F	P4.2 ■ 13 E	P4.3 ■ 10 D	M1.1 ■ 30 E	M1.2 ■ 26 E
M2.1 ■ 27 E	M2.2 ■ 22 E	M2.3 ■ 18 C	M3.1 ■ 13 G	M3.2 ■ 11 G	M3.3 ■ 10 C	M4.1 ■ 15 C	K1.1 ■ 35 H	K1.2 ■ 26 D	K1.3 ■ 19 D	K2.1 ■ 27 E	K2.2 ■ 22 E	K2.3 ■ 18 E	K3.1 ■ 24 E
K3.2 ■ 18 E	K3.3 ■ 15 E	K4.1 ■ 22 E	K4.2 ■ 17 E	K4.3 ■ 12 E	K4.4 ■ 11 E	K4.5 ■ 9 E	K5.1 ■ 25 E	K5.2 ■ 19 E	K5.3 ■ 15 E	N1.1 ■ 33 J	N1.2 ■ 25 J	N1.3 ■ 17 I	N2.1 ■ 46 H
N2.2 ■ 42 H	N2.3 ■ 30 H	N3.1 ■ 68 H	N3.2 ■ 40 F	N3.3 ■ 20 H	S1.1 ■ 28 F	S1.2 ■ 20 D	S1.3 ■ 11 C	S2.1 ■ 9 E	S2.2 ■ 8 B	S3.1 ■ 7 E	S3.2 ■ 6 B	S4.1 ■ 5 E	S4.2 ■ 5 B

Product	DC	DC	DC	LCF	OAL	DCON MS
	(inch)	(Wire gauge size)	(inch)	(inch)	(inch)	(inch)
R88C01/16	1/16	—	0.0625	7/16	1.7/8	0.063
R89CON52	—	N52	0.0635	7/16	1.7/8	0.064
R89CON51	—	N51	0.0670	1/2	2"	0.067
R89CON50	—	N50	0.0700	1/2	2"	0.070
R89CON49	—	N49	0.0730	1/2	2"	0.073
R88C05/64	5/64	—	0.0781	1/2	2"	0.078
R89CON46	—	N46	0.0810	9/16	2.1/8	0.081
R89CON45	—	N45	0.0820	9/16	2.1/8	0.082
R89CON44	—	N44	0.0860	9/16	2.1/8	0.086
R89CON43	—	N43	0.0890	5/8	2.1/4	0.089
R89CON42	—	N42	0.0935	5/8	2.1/4	0.093
R88C03/32	3/32	—	0.0938	5/8	2.1/4	0.094
R89CON41	—	N41	0.0960	5/8	2.3/8	0.096
R89CON40	—	N40	0.0980	13/16	2.3/8	0.098
R89CON39	—	N39	0.0995	13/16	2.3/8	0.100
R89CON36	—	N36	0.1065	13/16	2.1/2	0.106
R88C07/64	7/64	—	0.1094	13/16	2.5/8	0.109
R89CON31	—	N31	0.1200	7/8	2.3/4	0.120
R88C01/8	1/8	—	0.1250	7/8	2.3/4	0.125
R89CON30	—	N30	0.1285	15/16	2.3/4	0.129
R89CON29	—	N29	0.1360	15/16	2.7/8	0.136
R88C09/64	9/64	—	0.1406	15/16	2.7/8	0.141
R89CON27	—	N27	0.1440	1"	3"	0.144
R89CON26	—	N26	0.1470	1"	3"	0.147
R89CON25	—	N25	0.1495	1"	3"	0.149
R89CON24	—	N24	0.1520	1"	3.1/8	0.152
R88C05/32	5/32	—	0.1563	1"	3.1/8	0.156
R89CON22	—	N22	0.1570	1.1/16	3.1/8	0.157
R89CON21	—	N21	0.1590	1.1/16	3.1/4	0.159
R89CON20	—	N20	0.1610	1.1/16	3.1/4	0.161
R88C011/64	11/64	—	0.1719	1.1/16	3.1/4	0.172
R89CON16	—	N16	0.1770	1.1/8	3.3/8	0.177

Product	DC	DC	DC	LCF	OAL	DCON MS
	(inch)	(Wire gauge size)	(inch)	(inch)	(inch)	(inch)
R89CON13	—	N13	0.1850	1.1/8	3.1/2	0.188
R88C03/16	3/16	—	0.1875	1.1/8	3.1/2	0.185
R89CON12	—	N12	0.1890	1.1/8	3.1/2	0.189
R89CON11	—	N11	0.1910	1.3/16	3.1/2	0.191
R89CON10	—	N10	0.1935	1.3/16	3.5/8	0.194
R89CON9	—	N9	0.1960	1.3/16	3.5/8	0.196
R89CON8	—	N8	0.1990	1.3/16	3.5/8	0.199
R89CON7	—	N7	0.2010	1.3/16	3.5/8	0.201
R88C013/64	13/64	—	0.2031	1.3/16	3.5/8	0.203
R89CON6	—	N6	0.2040	1.1/4	3.3/4	0.204
R89CON5	—	N5	0.2055	1.1/4	3.3/4	0.205
R89CON3	—	N3	0.2130	1.1/4	3.3/4	0.213
R88C07/32	7/32	—	0.2188	1.1/4	3.3/4	0.219
R88C015/64	15/64	—	0.2344	1.5/16	3.7/8	0.234
R88C01/4	1/4	—	0.2500	1.3/8	4"	0.250
R88C017/64	17/64	—	0.2656	1.7/16	4.1/8	0.266
R88C09/32	9/32	—	0.2813	1.1/2	4.1/4	0.281
R88C019/64	19/64	—	0.2969	1.9/16	4.3/8	0.297
R88C05/16	5/16	—	0.3125	1.5/8	4.1/2	0.313
R88C021/64	21/64	—	0.3281	1.11/16	4.5/8	0.328
R88C011/32	11/32	—	0.3438	1.11/16	4.3/4	0.344
R88C023/64	23/64	—	0.3594	1.3/4	4.7/8	0.359
R88C03/8	3/8	—	0.3750	1.13/16	5"	0.375
R88C025/64	25/64	—	0.3906	1.7/8	5.1/8	0.391
R88C013/32	13/32	—	0.4063	1.15/16	5.1/4	0.406
R88C027/64	27/64	—	0.4219	2"	5.3/8	0.422
R88C07/16	7/16	—	0.4375	2.1/16	5.1/2	0.438
R88C029/64	29/64	—	0.4531	2.1/8	5.5/8	0.453
R88C015/32	15/32	—	0.4688	2.1/8	5.3/4	0.469
R88C031/64	31/64	—	0.4844	2.3/16	5.7/8	0.484
R88C01/2	1/2	—	0.5000	2.1/4	6"	0.500

R10CO/R15CO/R18CO

PRECISION

NAS 907 Tipo J Broca HSS-E (8%) Cobalto de serie corta para trabajos pesados

Broca de alta calidad que produce orificios de tamaño preciso con un mejor acabado. Punta hendida autocentrante de 135° y bajo empuje para facilitar la penetración. El acabado superficial de bronce templado ayuda a evitar que el material de la pieza de trabajo se adhiera a los filos de corte de la broca. Fabricada según las normas aeroespaciales NAS 907 Tipo J.

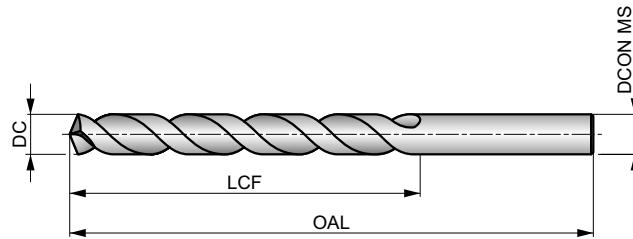

HSS-E	NAS 907	4xD
135°	Bronze	
20-35°		

Grupo de Material de la pieza adecuado y condiciones de velocidad de corte iniciales (m/min) y código de avance alfabético. Tablas con avance por revolución a partir de la pag.274.

P1.1 36 H	P1.2 40 H	P1.3 41 H	P2.1 31 H	P2.2 27 G	P2.3 24 E	P3.1 25 F	P3.2 20 F	P3.3 17 E	P4.1 15 F	P4.2 13 E	P4.3 10 D	M1.1 30 E	M1.2 26 E
M2.1 27 E	M2.2 22 E	M2.3 18 C	M3.1 13 G	M3.2 11 G	M3.3 10 C	M4.1 15 C	K1.1 35 H	K1.2 26 D	K1.3 19 D	K2.1 27 E	K2.2 22 E	K2.3 18 E	K3.1 24 E
K3.2 18 E	K3.3 15 E	K4.1 22 E	K4.2 17 E	K4.3 12 E	K4.4 11 E	K4.5 9 E	K5.1 25 E	K5.2 19 E	K5.3 15 E	N1.1 33 J	N1.2 25 J	N1.3 17 I	N2.1 46 H
N2.2 42 H	N2.3 30 H	N3.1 68 H	N3.2 40 F	N3.3 20 H	S1.1 28 F	S1.2 20 D	S1.3 11 C	S2.1 9 E	S2.2 8 B	S3.1 7 E	S3.2 6 B	S4.1 5 E	S4.2 5 B

Product	DC (inch)	DC (Wire gauge size)	DC (Letter size)	DC (inch)	LCF (inch)	OAL (inch)	DCON MS (inch)
R18CON80 ¹⁾	-	N80	-	0.0135	1/8	3/4	0.013
R18CON79 ¹⁾	-	N79	-	0.0145	1/8	3/4	0.015
R10C01/64 ¹⁾	1/64	-	-	0.0156	3/16	3/4	0.016
R18CON78 ¹⁾	-	N78	-	0.0160	3/16	7/8	0.016
R18CON77 ¹⁾	-	N77	-	0.0180	3/16	7/8	0.018
R18CON76 ¹⁾	-	N76	-	0.0200	3/16	7/8	0.020
R18CON75 ¹⁾	-	N75	-	0.0210	1/4	1"	0.021
R18CON74 ¹⁾	-	N74	-	0.0225	1/4	1"	0.022
R18CON73 ¹⁾	-	N73	-	0.0240	5/16	1.1/8	0.024
R18CON72 ¹⁾	-	N72	-	0.0250	5/16	1.1/8	0.025
R18CON71 ¹⁾	-	N71	-	0.0260	3/8	1.1/4	0.026
R18CON70 ¹⁾	-	N70	-	0.0280	3/8	1.1/4	0.028
R18CON69 ¹⁾	-	N69	-	0.0292	1/2	1.3/8	0.029
R18CON68 ¹⁾	-	N68	-	0.0310	1/2	1.3/8	0.031
R10C01/32 ¹⁾	1/32	-	-	0.0313	1/2	1.3/8	0.031
R18CON67 ¹⁾	-	N67	-	0.0320	1/2	1.3/8	0.032
R18CON66 ¹⁾	-	N66	-	0.0330	1/2	1.3/8	0.033
R18CON65 ¹⁾	-	N65	-	0.0350	5/8	1.1/2	0.035
R18CON64 ¹⁾	-	N64	-	0.0360	5/8	1.1/2	0.036
R18CON63 ¹⁾	-	N63	-	0.0370	5/8	1.1/2	0.037
R18CON62 ¹⁾	-	N62	-	0.0380	5/8	1.1/2	0.038
R18CON61 ¹⁾	-	N61	-	0.0390	11/16	1.5/8	0.039
R18CON60	-	N60	-	0.0400	11/16	1.5/8	0.040
R18CON59	-	N59	-	0.0410	11/16	1.5/8	0.041
R18CON58	-	N58	-	0.0420	11/16	1.5/8	0.042
R18CON57	-	N57	-	0.0430	3/4	1.3/4	0.043

Product	DC (inch)	DC (Wire gauge size)	DC (Letter size)	DC (inch)	LCF (inch)	OAL (inch)	DCON MS (inch)
R18CON56	-	N56	-	0.0465	3/4	1.3/4	0.046
R10C03/64	3/64	-	-	0.0469	3/4	1.3/4	0.047
R18CON55	-	N55	-	0.0520	7/8	1.7/8	0.052
R18CON54	-	N54	-	0.0550	7/8	1.7/8	0.055
R18CON53	-	N53	-	0.0595	7/8	1.7/8	0.059
R10C01/16	1/16	-	-	0.0625	7/8	1.7/8	0.063
R18CON52	-	N52	-	0.0635	7/8	1.7/8	0.064
R18CON51	-	N51	-	0.0670	1"	2"	0.067
R18CON50	-	N50	-	0.0700	1"	2"	0.070
R18CON49	-	N49	-	0.0730	1"	2"	0.073
R18CON48	-	N48	-	0.0760	1"	2"	0.076
R10C05/64	5/64	-	-	0.0781	1"	2"	0.078
R18CON47	-	N47	-	0.0785	1"	2"	0.079
R18CON46	-	N46	-	0.0810	1.1/8	2.1/8	0.081
R18CON45	-	N45	-	0.0820	1.1/8	2.1/8	0.082
R18CON44	-	N44	-	0.0860	1.1/8	2.1/8	0.086
R18CON43	-	N43	-	0.0890	1.1/4	2.1/4	0.089
R18CON42	-	N42	-	0.0935	1.1/4	2.1/4	0.093
R10C03/32	3/32	-	-	0.0938	1.1/4	2.1/4	0.094
R18CON41	-	N41	-	0.0960	1.3/8	2.3/8	0.096
R18CON40	-	N40	-	0.0980	1.3/8	2.3/8	0.098
R18CON39	-	N39	-	0.0995	1.3/8	2.3/8	0.100
R18CON38	-	N38	-	0.1015	1.7/16	2.1/2	0.102
R18CON37	-	N37	-	0.1040	1.7/16	2.1/2	0.104
R18CON36	-	N36	-	0.1065	1.7/16	2.1/2	0.106
R10C07/64	7/64	-	-	0.1094	1.1/2	2.5/8	0.109



Product	DC	DC	DC	DC	LCF	OAL	DCON MS
	(inch)	(Wire gauge size)	(Letter size)	(inch)	(inch)	(inch)	(inch)
R18CON35	–	N35	–	0.1100	1.1/2	2.5/8	0.110
R18CON34	–	N34	–	0.1110	1.1/2	2.5/8	0.111
R18CON33	–	N33	–	0.1130	1.1/2	2.5/8	0.113
R18CON32	–	N32	–	0.1160	1.5/8	2.3/4	0.116
R18CON31	–	N31	–	0.1200	1.5/8	2.3/4	0.120
R10C01/8	1/8	–	–	0.1250	1.5/8	2.3/4	0.125
R18CON30	–	N30	–	0.1285	1.5/8	2.3/4	0.129
R18CON29	–	N29	–	0.1360	1.3/4	2.7/8	0.136
R18CON28	–	N28	–	0.1405	1.3/4	2.7/8	0.141
R10C09/64	9/64	–	–	0.1406	1.3/4	2.7/8	0.141
R18CON27	–	N27	–	0.1440	1.7/8	3"	0.144
R18CON26	–	N26	–	0.1470	1.7/8	3"	0.147
R18CON25	–	N25	–	0.1495	1.7/8	3"	0.149
R18CON24	–	N24	–	0.1520	2"	3.1/8	0.152
R18CON23	–	N23	–	0.1540	2"	3.1/8	0.154
R10C05/32	5/32	–	–	0.1563	2"	3.1/8	0.156
R18CON22	–	N22	–	0.1570	2"	3.1/8	0.157
R18CON21	–	N21	–	0.1590	2.1/8	3.1/4	0.159
R18CON20	–	N20	–	0.1610	2.1/8	3.1/4	0.161
R18CON19	–	N19	–	0.1660	2.1/8	3.1/4	0.166
R18CON18	–	N18	–	0.1695	2.1/8	3.1/4	0.170
R10C011/64	11/64	–	–	0.1719	2.1/8	3.1/4	0.172
R18CON17	–	N17	–	0.1730	2.3/16	3.3/8	0.173
R18CON16	–	N16	–	0.1770	2.3/16	3.3/8	0.177
R18CON15	–	N15	–	0.1800	2.3/16	3.3/8	0.180
R18CON14	–	N14	–	0.1820	2.3/16	3.3/8	0.182
R18CON13	–	N13	–	0.1850	2.5/16	3.1/2	0.185
R10C03/16	3/16	–	–	0.1875	2.5/16	3.1/2	0.188
R18CON12	–	N12	–	0.1890	2.5/16	3.1/2	0.189
R18CON11	–	N11	–	0.1910	2.5/16	3.1/2	0.191
R18CON10	–	N10	–	0.1935	2.7/16	3.5/8	0.194
R18CON9	–	N9	–	0.1960	2.7/16	3.5/8	0.196
R18CON8	–	N8	–	0.1990	2.7/16	3.5/8	0.199
R18CON7	–	N7	–	0.2010	2.7/16	3.5/8	0.201
R10C013/64	13/64	–	–	0.2031	2.7/16	3.5/8	0.203
R18CON6	–	N6	–	0.2040	2.1/2	3.3/4	0.204
R18CON5	–	N5	–	0.2055	2.1/2	3.3/4	0.205
R18CON4	–	N4	–	0.2090	2.1/2	3.3/4	0.209
R18CON3	–	N3	–	0.2130	2.1/2	3.3/4	0.213
R10C07/32	7/32	–	–	0.2188	2.1/2	3.3/4	0.219
R18CON2	–	N2	–	0.2210	2.5/8	3.7/8	0.221
R18CON1	–	N1	–	0.2280	2.5/8	3.7/8	0.228
R15COA	–	–	A	0.2340	2.5/8	3.7/8	0.234
R10C015/64	15/64	–	–	0.2344	2.5/8	3.7/8	0.234
R15COB	–	–	B	0.2380	2.3/4	4"	0.238
R15COC	–	–	C	0.2420	2.3/4	4"	0.242
R15COD	–	–	D	0.2460	2.3/4	4"	0.246
R10C01/4	1/4	–	–	0.2500	2.3/4	4"	0.250
R15COF	–	–	F	0.2570	2.7/8	4.1/8	0.257

¹⁾ Sin punta dividida.

Product	DC	DC	DC	DC	LCF	OAL	DCON MS
	(inch)	(Wire gauge size)	(Letter size)	(inch)	(inch)	(inch)	(inch)
R15COG	–	–	G	0.2610	2.7/8	4.1/8	0.261
R10C017/64	17/64	–	–	0.2656	2.7/8	4.1/8	0.266
R15COH	–	–	H	0.2660	2.7/8	4.1/8	0.266
R15COI	–	–	I	0.2720	2.7/8	4.1/8	0.272
R15COJ	–	–	J	0.2770	2.7/8	4.1/8	0.277
R15COK	–	–	K	0.2810	2.15/16	4.1/4	0.281
R10C09/32	9/32	–	–	0.2813	2.15/16	4.1/4	0.281
R15COL	–	–	L	0.2900	2.15/16	4.1/4	0.290
R15COM	–	–	M	0.2950	3.1/16	4.3/8	0.295
R10C019/64	19/64	–	–	0.2969	3.1/16	4.3/8	0.297
R15CON	–	–	N	0.3020	3.1/16	4.3/8	0.302
R10C05/16	5/16	–	–	0.3125	3.3/16	4.1/2	0.313
R15COO	–	–	O	0.3160	3.3/16	4.1/2	0.316
R15COP	–	–	P	0.3230	3.5/16	4.5/8	0.323
R10C021/64	21/64	–	–	0.3281	3.5/16	4.5/8	0.328
R15COQ	–	–	Q	0.3320	3.7/16	4.3/4	0.332
R15COR	–	–	R	0.3390	3.7/16	4.3/4	0.339
R10C011/32	11/32	–	–	0.3438	3.7/16	4.3/4	0.344
R15COS	–	–	S	0.3480	3.1/2	4.7/8	0.348
R15COT	–	–	T	0.3580	3.1/2	4.7/8	0.358
R10C023/64	23/64	–	–	0.3594	3.1/2	4.7/8	0.359
R15COU	–	–	U	0.3680	3.5/8	5"	0.368
R10C03/8	3/8	–	–	0.3750	3.5/8	5"	0.375
R15COV	–	–	V	0.3770	3.5/8	5"	0.377
R15COW	–	–	W	0.3860	3.3/4	5.1/8	0.386
R10C025/64	25/64	–	–	0.3906	3.3/4	5.1/8	0.391
R15COX	–	–	X	0.3970	3.3/4	5.1/8	0.397
R15COY	–	–	Y	0.4040	3.7/8	5.1/4	0.404
R10C013/32	13/32	–	–	0.4063	3.7/8	5.1/4	0.406
R15COZ	–	–	Z	0.4130	3.7/8	5.1/4	0.413
R10C027/64	27/64	–	–	0.4219	3.15/16	5.3/8	0.422
R10C07/16	7/16	–	–	0.4375	4.1/16	5.1/2	0.438
R10C029/64	29/64	–	–	0.4531	4.3/16	5.5/8	0.453
R10C015/32	15/32	–	–	0.4688	4.5/16	5.3/4	0.469
R10C031/64	31/64	–	–	0.4844	4.3/8	5.7/8	0.484
R10C01/2	1/2	–	–	0.5000	4.1/2	6"	0.500
R10C033/64	33/64	–	–	0.5156	4.13/16	6.5/8	0.516
R10C017/32	17/32	–	–	0.5313	4.13/16	6.5/8	0.531
R10C035/64	35/64	–	–	0.5469	4.13/16	6.5/8	0.547
R10C09/16	9/16	–	–	0.5625	4.13/16	6.5/8	0.563
R10C037/64	37/64	–	–	0.5781	4.13/16	6.5/8	0.578
R10C019/32	19/32	–	–	0.5938	5.3/16	7.1/8	0.594
R10C039/64	39/64	–	–	0.6094	5.3/16	7.1/8	0.609
R10C05/8	5/8	–	–	0.6250	5.3/16	7.1/8	0.625
R10C041/64	41/64	–	–	0.6406	5.3/16	7.1/8	0.641
R10C021/32	21/32	–	–	0.6563	5.3/16	7.1/8	0.656
R10C043/64	43/64	–	–	0.6719	5.5/8	7.5/8	0.672
R10C011/16	11/16	–	–	0.6875	5.5/8	7.5/8	0.688

CO500-6/CO501-6

PRECISION



NAS 907 Tipo B Broca HSS-E extralarga para aeronaves, 6" OAL

Las brocas de serie larga, fabricadas según las Normas Aeroespaciales Nacionales, con una longitud total larga en combinación con una longitud de estria corta, son ideales para taladrar en zonas de difícil acceso. El material al cobalto, la punta dividida de 135° y el acabado superficial de bronce templado mejoran la vida útil de la herramienta al taladrar la mayoría de los materiales.

HSS-E	NAS 907	4xD

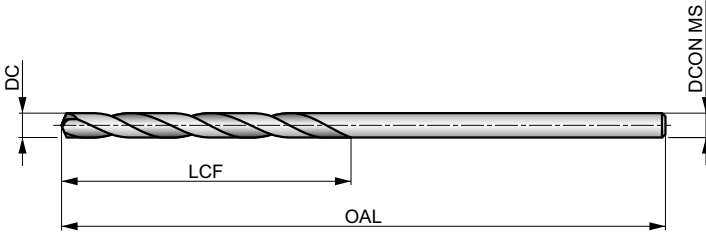

Grupo de Material de la pieza adecuado y condiciones de velocidad de corte iniciales (m/min) y código de avance alfabético. Tablas con avance por revolución a partir de la pag.274.

P1.1 ■ 36 G	P1.2 ■ 40 G	P1.3 ■ 41 G	P2.1 ■ 31 G	P2.2 ■ 27 E	P2.3 ■ 24 D	P3.1 ■ 25 E	P3.2 ■ 20 E	P3.3 ■ 17 D	P4.1 ■ 15 E	P4.2 ■ 13 D	P4.3 ■ 10 B	M1.1 ■ 30 H	M1.2 ■ 26 H
M2.1 ■ 27 H	M2.2 ■ 22 H	M2.3 ■ 18 D	M3.1 ■ 13 F	M3.2 ■ 11 F	M3.3 ■ 10 D	M4.1 ■ 15 D	M4.2 ■ 13 D	K1.1 ■ 35 H	K1.2 ■ 26 H	K1.3 ■ 19 H	K2.1 ■ 27 F	K2.2 ■ 22 F	K2.3 ■ 18 D
K3.1 ■ 24 F	K3.2 ■ 18 F	K3.3 ■ 15 D	K4.1 ■ 22 F	K4.2 ■ 17 F	K4.3 ■ 12 D	K4.4 ■ 11 D	K4.5 ■ 9 D	K5.1 ■ 25 F	K5.2 ■ 19 F	K5.3 ■ 15 D	N1.1 ■ 32 I	N1.2 ■ 24 I	N1.3 ■ 16 H
N2.1 ■ 42 G	N2.2 ■ 37 G	N2.3 ■ 27 G	N3.1 ■ 54 G	N3.2 ■ 32 H	N3.3 ■ 16 E	N4.1 ■ 35 I	N4.2 ■ 26 G	N4.3 ■ 12 E	S1.3 ■ 6 D	S2.1 ■ 8 B	S2.2 ■ 7 B	S3.1 ■ 6 B	S3.2 ■ 5 B
S4.1 ■ 5 B	S4.2 ■ 4 B												

Product	DC (inch)	DC (Wire gauge size)	DC (inch)	LCF (inch)	OAL (inch)	D CON MS (inch)
CO500-61/16	1/16	-	0.0625	7/8	6"	0.063
CO501-6N52	-	N52	0.0635	7/8	6"	0.064
CO501-6N51	-	N51	0.0670	1"	6"	0.067
CO501-6N50	-	N50	0.0700	1"	6"	0.070
CO501-6N49	-	N49	0.0730	1"	6"	0.073
CO501-6N48	-	N48	0.0760	1"	6"	0.076
CO500-65/64	5/64	-	0.0781	1"	6"	0.078
CO501-6N47	-	N47	0.0785	1"	6"	0.079
CO501-6N46	-	N46	0.0810	1.1/8	6"	0.081
CO501-6N45	-	N45	0.0820	1.1/8	6"	0.082
CO501-6N44	-	N44	0.0860	1.1/8	6"	0.086
CO501-6N43	-	N43	0.0890	1.1/4	6"	0.089
CO501-6N42	-	N42	0.0935	1.1/4	6"	0.093
CO500-63/32	3/32	-	0.0938	1.1/4	6"	0.094
CO501-6N41	-	N41	0.0960	1.3/8	6"	0.096
CO501-6N40	-	N40	0.0980	1.3/8	6"	0.098
CO501-6N39	-	N39	0.0995	1.3/8	6"	0.100
CO501-6N38	-	N38	0.1015	1.7/16	6"	0.102
CO501-6N37	-	N37	0.1040	1.7/16	6"	0.104
CO501-6N36	-	N36	0.1065	1.7/16	6"	0.106
CO500-67/64	7/64	-	0.1094	1.1/2	6"	0.109
CO501-6N35	-	N35	0.1100	1.1/2	6"	0.110
CO501-6N34	-	N34	0.1110	1.1/2	6"	0.111
CO501-6N33	-	N33	0.1130	1.1/2	6"	0.113
CO501-6N32	-	N32	0.1160	1.5/8	6"	0.116
CO501-6N31	-	N31	0.1200	1.5/8	6"	0.120
CO500-61/8	1/8	-	0.1250	1.5/8	6"	0.125
CO501-6N30	-	N30	0.1285	1.5/8	6"	0.129
CO501-6N29	-	N29	0.1360	1.3/4	6"	0.136
CO501-6N28	-	N28	0.1405	1.3/4	6"	0.141
CO500-69/64	9/64	-	0.1406	1.3/4	6"	0.141
CO501-6N27	-	N27	0.1440	1.7/8	6"	0.144
CO501-6N26	-	N26	0.1470	1.7/8	6"	0.147

Product	DC (inch)	DC (Wire gauge size)	DC (inch)	LCF (inch)	OAL (inch)	D CON MS (inch)
CO501-6N25	-	N25	0.1495	1.7/8	6"	0.149
CO501-6N24	-	N24	0.1520	2"	6"	0.152
CO501-6N23	-	N23	0.1540	2"	6"	0.154
CO500-65/32	5/32	-	0.1563	2"	6"	0.156
CO501-6N22	-	N22	0.1570	2"	6"	0.157
CO501-6N21	-	N21	0.1590	2.1/8	6"	0.159
CO501-6N20	-	N20	0.1610	2.1/8	6"	0.161
CO501-6N19	-	N19	0.1660	2.1/8	6"	0.166
CO501-6N18	-	N18	0.1695	2.1/8	6"	0.170
CO500-611/64	11/64	-	0.1719	2.1/8	6"	0.172
CO501-6N17	-	N17	0.1730	2.3/16	6"	0.173
CO501-6N16	-	N16	0.1770	2.3/16	6"	0.177
CO501-6N15	-	N15	0.1800	2.3/16	6"	0.180
CO501-6N14	-	N14	0.1820	2.3/16	6"	0.182
CO501-6N13	-	N13	0.1850	2.5/16	6"	0.185
CO500-63/16	3/16	-	0.1875	2.5/16	6"	0.188
CO501-6N12	-	N12	0.1890	2.5/16	6"	0.189
CO501-6N11	-	N11	0.1910	2.5/16	6"	0.191
CO501-6N10	-	N10	0.1935	2.7/16	6"	0.194
CO501-6N9	-	N9	0.1960	2.7/16	6"	0.196
CO501-6N8	-	N8	0.1990	2.7/16	6"	0.199
CO501-6N7	-	N7	0.2010	2.7/16	6"	0.201
CO500-613/64	13/64	-	0.2031	2.7/16	6"	0.203
CO501-6N6	-	N6	0.2040	2.1/2	6"	0.204
CO501-6N5	-	N5	0.2055	2.1/2	6"	0.205
CO501-6N4	-	N4	0.2090	2.1/2	6"	0.209
CO501-6N3	-	N3	0.2130	2.1/2	6"	0.213
CO500-67/32	7/32	-	0.2188	2.1/2	6"	0.219
CO501-6N2	-	N2	0.2210	2.5/8	6"	0.221
CO501-6N1	-	N1	0.2280	2.5/8	6"	0.228
CO500-615/64	15/64	-	0.2344	2.5/8	6"	0.234
CO500-61/4	1/4	-	0.2500	2.3/4	6"	0.250

CO500-12/CO501-12

PRECISION

NAS 907 Tipo B Broca HSS-E extralarga para aeronaves, 12" OAL

Las brocas de la serie extralarga, fabricadas según las Normas Aeroespaciales Nacionales, con una longitud total extralarga combinada con una longitud de estria corta, son ideales para taladrar en zonas de difícil acceso. El material de cobalto, la punta dividida de 135° y el acabado superficial de bronce templado mejoran la vida útil de la herramienta al taladrar la mayoría de los materiales.

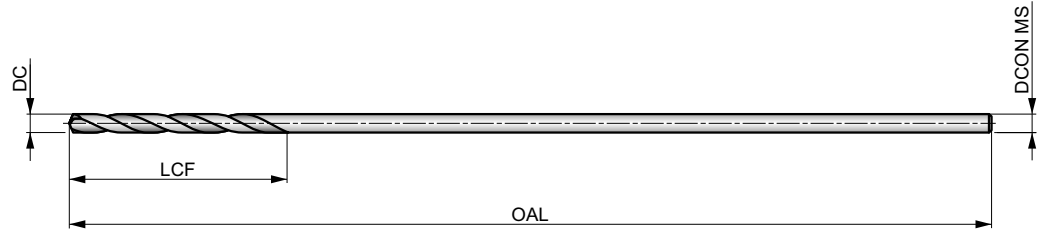

HSS-E	NAS 907	4xD
135°	Bronze	
λ 20-35°	R	

Grupo de Material de la pieza adecuado y condiciones de velocidad de corte iniciales (m/min) y código de avance alfabético. Tablas con avance por revolución a partir de la pag.274.

P1.1 ■ 36 G	P1.2 ■ 40 G	P1.3 ■ 41 G	P2.1 ■ 31 G	P2.2 ■ 27 E	P2.3 ■ 24 D	P3.1 ■ 25 E	P3.2 ■ 20 E	P3.3 ■ 17 D	P4.1 ■ 15 E	P4.2 ■ 13 D	P4.3 ■ 10 B	M1.1 ■ 30 H	M1.2 ■ 26 H
M2.1 ■ 27 H	M2.2 ■ 22 H	M2.3 ■ 18 D	M3.1 ■ 13 F	M3.2 ■ 11 F	M3.3 ■ 10 D	M4.1 ■ 15 D	M4.2 ■ 13 D	K1.1 ■ 35 H	K1.2 ■ 26 H	K1.3 ■ 19 H	K2.1 ■ 27 F	K2.2 ■ 22 F	K2.3 ■ 18 D
K3.1 ■ 24 F	K3.2 ■ 18 F	K3.3 ■ 15 D	K4.1 ■ 22 F	K4.2 ■ 17 F	K4.3 ■ 12 D	K4.4 ■ 11 D	K4.5 ■ 9 D	K5.1 ■ 25 F	K5.2 ■ 19 F	K5.3 ■ 15 D	N1.1 ■ 32 I	N1.2 ■ 24 I	N1.3 ■ 16 H
N2.1 ■ 42 G	N2.2 ■ 37 G	N2.3 ■ 27 G	N3.1 ■ 54 G	N3.2 ■ 32 H	N3.3 ■ 16 E	N4.1 ■ 35 I	N4.2 ■ 26 G	N4.3 ■ 12 E	S1.3 ■ 6 D	S2.1 ■ 8 B	S2.2 ■ 7 B	S3.1 ■ 6 B	S3.2 ■ 5 B
S4.1 ■ 5 B	S4.2 ■ 4 B												

Product	DC (inch)	DC (Wire gauge size)	DC (inch)	LCF (inch)	OAL (inch)	DCON MS (inch)
CO500-121/16	1/16	—	0.0625	7/8	12"	0.063
CO500-125/64	5/64	—	0.0781	1"	12"	0.078
CO500-123/32	3/32	—	0.0938	1.1/4	12"	0.094
CO501-12N40	—	N40	0.0980	1.3/8	12"	0.098
CO500-127/64	7/64	—	0.1094	1.1/2	12"	0.109
CO500-121/8	1/8	—	0.1250	1.5/8	12"	0.125
CO501-12N30	—	N30	0.1285	1.5/8	12"	0.129
CO501-12N29	—	N29	0.1360	1.3/4	12"	0.136
CO500-129/64	9/64	—	0.1406	1.3/4	12"	0.141
CO500-125/32	5/32	—	0.1563	2"	12"	0.156
CO501-12N21	—	N21	0.1590	2.1/8	12"	0.159

Product	DC (inch)	DC (Wire gauge size)	DC (inch)	LCF (inch)	OAL (inch)	DCON MS (inch)
CO501-12N20	—	N20	0.1610	2.1/8	12"	0.161
CO500-1211/64	11/64	—	0.1719	2.1/8	12"	0.172
CO501-12N16	—	N16	0.1770	2.3/16	12"	0.177
CO500-123/16	3/16	—	0.1875	2.5/16	12"	0.188
CO501-12N11	—	N11	0.1910	2.5/16	12"	0.191
CO501-12N10	—	N10	0.1935	2.7/16	12"	0.194
CO500-1213/64	13/64	—	0.2031	2.7/16	12"	0.203
CO500-127/32	7/32	—	0.2188	2.1/2	12"	0.219
CO501-12N2	—	N2	0.2210	2.5/8	12"	0.221
CO500-1215/64	15/64	—	0.2344	2.5/8	12"	0.234
CO500-121/4	1/4	—	0.2500	2.3/4	12"	0.250

2ACO

PRECISION



NAS 907 Tipo J Broca HSS-E para trabajos pesados, acabado superficial bronce templado, medidas métricas

Broca de alta calidad que produce orificios de tamaño preciso con un mejor acabado. Punta hendida autocentrante de 135° y bajo empuje para facilitar la penetración. El acabado superficial de bronce templado ayuda a evitar que el material de la pieza de trabajo se adhiera a los filos de corte de la broca. Fabricada según las normas aeroespaciales NAS 907 Tipo J.

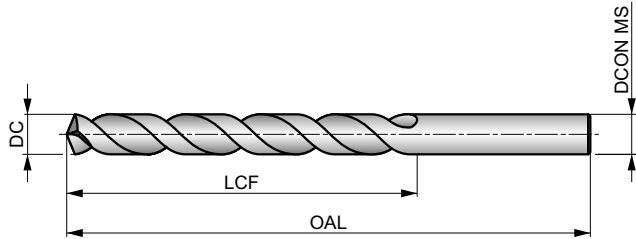

HSS-E	DIN 338	4×D
135°	Bronze	
λ 20-35°	R	

Grupo de Material de la pieza adecuado y condiciones de velocidad de corte iniciales (m/min) y código de avance alfabético. Tablas con avance por revolución a partir de la pag.274.

P1.1 ■36 H	P1.2 ■40 H	P1.3 ■41 H	P2.1 ■31 H	P2.2 ■27 G	P2.3 ■24 E	P3.1 ■25 F	P3.2 ■20 F	P3.3 ■17 E	P4.1 ■15 F	P4.2 ■13 E	P4.3 ■10 D	M1.1 ■30 E	M1.2 ■26 E
M2.1 ■27 E	M2.2 ■22 E	M2.3 ■18 C	M3.1 ■13 G	M3.2 ■11 G	M3.3 ■10 C	M4.1 ■15 C	K1.1 ■35 H	K1.2 ■26 D	K1.3 ■19 D	K2.1 ■27 E	K2.2 ■22 E	K2.3 ■18 E	K3.1 ■24 E
K3.2 ■18 E	K3.3 ■15 E	K4.1 ■22 E	K4.2 ■17 E	K4.3 ■12 E	K4.4 ■11 E	K4.5 ■9 E	K5.1 ■25 E	K5.2 ■19 E	K5.3 ■15 E	N1.1 ■33 J	N1.2 ■25 J	N1.3 ■17 I	N2.1 ■46 H
N2.2 ■42 H	N2.3 ■30 H	N3.1 ■68 H	N3.2 ■40 F	N3.3 ■20 H	S1.1 ■28 F	S1.2 ■20 D	S1.3 ■11 C	S2.1 ■9 E	S2.2 ■8 B	S3.1 ■7 E	S3.2 ■6 B	S4.1 ■5 E	S4.2 ■5 B

Product	DC (mm)	DC (inch)	LCF (mm)	OAL (mm)	DCON MS (mm)
2AC01.0	1.00	0.0394	12.0	34.0	1.00
2AC01.05	1.05	0.0413	12.0	34.0	1.05
2AC01.1	1.10	0.0433	14.0	36.0	1.10
2AC01.15	1.15	0.0453	14.0	36.0	1.15
2AC01.2	1.20	0.0472	16.0	38.0	1.20
2AC01.25	1.25	0.0492	16.0	38.0	1.25
2AC01.3	1.30	0.0512	16.0	38.0	1.30
2AC01.35	1.35	0.0531	18.0	40.0	1.35
2AC01.4	1.40	0.0551	18.0	40.0	1.40
2AC01.45	1.45	0.0571	18.0	40.0	1.45
2AC01.5	1.50	0.0591	18.0	40.0	1.50
2AC01.55	1.55	0.0610	20.0	43.0	1.55
2AC01.6	1.60	0.0630	20.0	43.0	1.60
2AC01.65	1.65	0.0650	20.0	43.0	1.65
2AC01.7	1.70	0.0669	20.0	43.0	1.70
2AC01.75	1.75	0.0689	22.0	46.0	1.75
2AC01.8	1.80	0.0709	22.0	46.0	1.80
2AC01.85	1.85	0.0728	22.0	46.0	1.85
2AC01.9	1.90	0.0748	22.0	46.0	1.90
2AC01.95	1.95	0.0768	24.0	49.0	1.95
2AC02.0	2.00	0.0787	24.0	49.0	2.00
2AC02.05	2.05	0.0807	24.0	49.0	2.05
2AC02.1	2.10	0.0827	24.0	49.0	2.10
2AC02.2	2.20	0.0866	27.0	53.0	2.20
2AC02.3	2.30	0.0906	27.0	53.0	2.30
2AC02.35	2.35	0.0925	27.0	53.0	2.35

Product	DC (mm)	DC (inch)	LCF (mm)	OAL (mm)	DCON MS (mm)
2AC02.4	2.40	0.0945	30.0	57.0	2.40
2AC02.5	2.50	0.0984	30.0	57.0	2.50
2AC02.6	2.60	0.1024	30.0	57.0	2.60
2AC02.7	2.70	0.1063	33.0	61.0	2.70
2AC02.8	2.80	0.1102	33.0	61.0	2.80
2AC02.9	2.90	0.1142	33.0	61.0	2.90
2AC03.0	3.00	0.1181	33.0	61.0	3.00
2AC03.1	3.10	0.1220	36.0	65.0	3.10
2AC03.2	3.20	0.1260	36.0	65.0	3.20
2AC03.25	3.25	0.1280	36.0	65.0	3.25
2AC03.3	3.30	0.1299	36.0	65.0	3.30
2AC03.4	3.40	0.1339	39.0	70.0	3.40
2AC03.5	3.50	0.1378	39.0	70.0	3.50
2AC03.6	3.60	0.1417	39.0	70.0	3.60
2AC03.7	3.70	0.1457	39.0	70.0	3.70
2AC03.75	3.75	0.1476	39.0	70.0	3.75
2AC03.8	3.80	0.1496	43.0	75.0	3.80
2AC04.0	4.00	0.1575	43.0	75.0	4.00
2AC04.1	4.10	0.1614	43.0	75.0	4.10
2AC04.2	4.20	0.1654	43.0	75.0	4.20
2AC04.25	4.25	0.1673	43.0	75.0	4.25
2AC04.3	4.30	0.1693	47.0	80.0	4.30
2AC04.4	4.40	0.1732	47.0	80.0	4.40
2AC04.5	4.50	0.1772	47.0	80.0	4.50
2AC04.7	4.70	0.1850	47.0	80.0	4.70
2AC04.8	4.80	0.1890	52.0	86.0	4.80



Product	DC	DC	LCF	OAL	DCON MS
	(mm)	(inch)	(mm)	(mm)	(mm)
2AC05.0	5.00	0.1969	52.0	86.0	5.00
2AC05.1	5.10	0.2008	52.0	86.0	5.10
2AC05.2	5.20	0.2047	52.0	86.0	5.20
2AC05.25	5.25	0.2067	52.0	86.0	5.25
2AC05.3	5.30	0.2087	52.0	86.0	5.30
2AC05.5	5.50	0.2165	57.0	93.0	5.50
2AC05.6	5.60	0.2205	57.0	93.0	5.60
2AC05.7	5.70	0.2244	57.0	93.0	5.70
2AC05.9	5.90	0.2323	57.0	93.0	5.90
2AC06.0	6.00	0.2362	57.0	93.0	6.00
2AC06.1	6.10	0.2402	63.0	101.0	6.10
2AC06.2	6.20	0.2441	63.0	101.0	6.20
2AC06.3	6.30	0.2480	63.0	101.0	6.30
2AC06.4	6.40	0.2520	63.0	101.0	6.40
2AC06.5	6.50	0.2559	63.0	101.0	6.50
2AC06.6	6.60	0.2598	63.0	101.0	6.60
2AC06.7	6.70	0.2638	63.0	101.0	6.70
2AC06.8	6.80	0.2677	69.0	109.0	6.80
2AC06.9	6.90	0.2717	69.0	109.0	6.90
2AC07.0	7.00	0.2756	69.0	109.0	7.00
2AC07.1	7.10	0.2795	69.0	109.0	7.10
2AC07.2	7.20	0.2835	69.0	109.0	7.20
2AC07.25	7.25	0.2854	69.0	109.0	7.25
2AC07.3	7.30	0.2874	69.0	109.0	7.30
2AC07.5	7.50	0.2953	69.0	109.0	7.50
2AC07.8	7.80	0.3071	75.0	117.0	7.80
2AC07.9	7.90	0.3110	75.0	117.0	7.90

Product	DC	DC	LCF	OAL	DCON MS
	(mm)	(inch)	(mm)	(mm)	(mm)
2AC08.0	8.00	0.3150	75.0	117.0	8.00
2AC08.2	8.20	0.3228	75.0	117.0	8.20
2AC08.4	8.40	0.3307	75.0	117.0	8.40
2AC08.5	8.50	0.3346	75.0	117.0	8.50
2AC08.8	8.80	0.3465	81.0	125.0	8.80
2AC08.9	8.90	0.3504	81.0	125.0	8.90
2AC09.0	9.00	0.3543	81.0	125.0	9.00
2AC09.1	9.10	0.3583	81.0	125.0	9.10
2AC09.2	9.20	0.3622	81.0	125.0	9.20
2AC09.3	9.30	0.3661	81.0	125.0	9.30
2AC09.4	9.40	0.3701	81.0	125.0	9.40
2AC09.5	9.50	0.3740	81.0	125.0	9.50
2AC09.6	9.60	0.3780	87.0	133.0	9.60
2AC09.7	9.70	0.3819	87.0	133.0	9.70
2AC09.8	9.80	0.3858	87.0	133.0	9.80
2AC010.0	10.00	0.3937	87.0	133.0	10.00
2AC010.2	10.20	0.4016	87.0	133.0	10.20
2AC010.5	10.50	0.4134	87.0	133.0	10.50
2AC010.8	10.80	0.4252	94.0	142.0	10.80
2AC011.0	11.00	0.4331	94.0	142.0	11.00
2AC011.2	11.20	0.4409	94.0	142.0	11.20
2AC011.5	11.50	0.4528	94.0	142.0	11.50
2AC011.8	11.80	0.4646	94.0	142.0	11.80
2AC012.0	12.00	0.4724	101.0	151.0	12.00
2AC012.2	12.20	0.4803	101.0	151.0	12.20
2AC012.5	12.50	0.4921	101.0	151.0	12.50
2AC013.0	13.00	0.5118	101.0	151.0	13.00

Código de Material (BMC)	HSS	HSS	HSS	HSS	HSS	HSS	HSS	HSS	HSS	HSS-E	HSS
Recubrimiento	Bright	Bright	Bright	Bright	Bright	Bright	Bright	Bright	TiAlN	Bright	Bright
Grupo básico estándar (BSG)	DIN 334C	DIN 335C	DORMER	DIN 335A	ANSI	DIN 335C	DIN 335C	DIN 335C	DIN 335C	DORMER	DORMER
Mano (dirección de corte)	R	R	R	R	R	R	R	R	R	R	R
Mango											
Ángulo de aplicación	60°	82°	90°	90°		90°	90°	90°	90°	90°	90°



Código de Familia de Producto	G135	G154	G129	G132	B690	G142	G136	G106	G506	G107	G600	G236
Gama de diámetros de corte PSF	6.30 - 25.00	6.30 - 25.00	6.00 - 31.50	8.00 - 20.00	1/4 - 1"	5.00 - 31.00	4.30 - 31.00	6.30 - 50.00	6.30 - 50.00	6.30 - 20.50	6.30 - 25.00	Set
	60	61	62	63	64	65	66	67	68	69	70	71

P	P1	■	■	■	■	■	■	■	■	■	■	■
	P2	■	■	■	■	■	■	■	■	■	■	■
	P3	■	■	■	■	■	■	■	■	■	■	■
	P4	■	■	■	■	■	■	■	■	■	■	■
M	M1	■	■	■	■	■	■	■	■	■	■	■
	M2	■	■	■	■	■	■	■	■	■	■	■
	M3				■	■	■					
	M4				■	■	■					
K	K1	■	■	■	■	■	■	■	■	■	■	■
	K2	■	■	■	■	■	■	■	■	■	■	■
	K3	■	■	■	■	■	■	■	■	■	■	■
	K4				■	■			■	■		
	K5	■	■		■	■	■	■	■	■	■	■
N	N1	■	■	■	■	■	■	■	■	■	■	■
	N2	■	■	■	■	■	■	■	■	■	■	■
	N3	■	■	■	■	■	■	■	■	■	■	■
	N4	■	■	■	■	■	■	■	■	■	■	■
	N5											
S	S1											
	S2											
	S3											
	S4											
H	H1											
	H2											
	H3											
	H4											

G135

DORMER



Avellanador a 60°, Mango Cilíndrico, Acabado Brillante

Con ángulo de 60° para achaflanar agujeros para tornillos especiales y eliminar rebabas de agujeros taladrados en diámetros de hasta 25,0 mm. Para uso en operaciones manuales y en máquinas. Adecuado para achaflanar agujeros en muchos materiales.

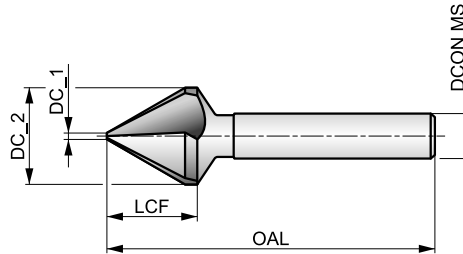

HSS	Bright	DIN 334C
R		60°

Grupo de Material de la pieza adecuado y condiciones de velocidad de corte iniciales (m/min) y código de avance alfabético. Tablas con avance por revolución a partir de la pag.280.

P1.1 ■ 23 E	P1.2 ■ 26 E	P1.3 ■ 27 E	P2.1 ■ 20 E	P2.2 ■ 18 D	P2.3 ■ 16 B	P3.1 ■ 16 D	P3.2 ■ 13 D	P3.3 ■ 11 B	P4.1 ■ 10 D	P4.2 ■ 8 B	M1.1 ■ 8 C	M1.2 ■ 16 C	M2.1 ■ 17 C
M2.2 ■ 16 C	K1.1 ■ 20 F	K1.2 ■ 15 D	K2.1 ■ 21 C	K2.2 ■ 17 C	K3.1 ■ 18 C	K3.2 ■ 14 C	K5.1 ■ 19 C	K5.2 ■ 15 C	N1.1 ■ 40 G	N1.2 ■ 30 G	N1.3 ■ 20 F	N2.1 ■ 20 F	N2.2 ■ 18 F
N3.1 ■ 21 F	N3.2 ■ 12 F	N3.3 ■ 16 D	N4.1 ■ 40 G	N4.2 ■ 35 G									

DCON MS tolerancia h9.

Product	DC_2 (mm)	DC_1 (mm)	LCF (mm)	OAL (mm)	DCON MS (mm)	NOF
G1356.3	6.30	1.60	6.8	45.0	5.00	3
G1358.0	8.00	2.00	8.5	50.0	6.00	3
G13510.0	10.00	2.50	7.6	50.0	6.00	3
G13512.5	12.50	3.20	11.7	56.0	8.00	3
G13516.0	16.00	4.00	14.5	63.0	10.00	3
G13520.0	20.00	5.00	17.5	67.0	10.00	3
G13525.0	25.00	6.30	20.5	71.0	10.00	3

G154

DORMER



Avellanador HSS a 82°, Mango Cilíndrico, Acabado Brillante

Avellanador de 82 ° para tornillos de cabeza plana y para achaflanar agujeros. Herramienta versátil para uso tanto en máquinas como en taladros manuales. Adecuado para achaflanar agujeros en la mayoría de materiales.

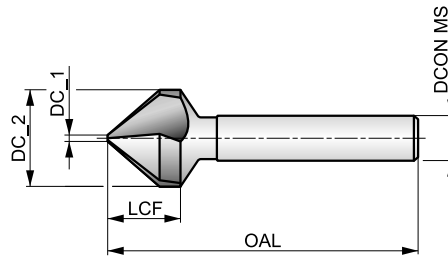

HSS	Bright	DIN 335C
R		82°

Grupo de Material de la pieza adecuado y condiciones de velocidad de corte iniciales (m/min) y código de avance alfabético. Tablas con avance por revolución a partir de la pag.280.

P1.1 ■ 23 E	P1.2 ■ 26 E	P1.3 ■ 27 E	P2.1 ■ 20 E	P2.2 ■ 18 D	P2.3 ▧ 16 B	P3.1 ■ 16 D	P3.2 ■ 13 D	P3.3 ▧ 11 B	P4.1 ■ 10 D	P4.2 ▧ 8 B	M1.1 ▧ 8 C	M1.2 ▧ 16 C	M2.1 ▧ 17 C
M2.2 ▧ 6 C	K1.1 ▧ 20 F	K1.2 ▧ 15 D	K2.1 ▧ 21 C	K2.2 ▧ 17 C	K3.1 ▧ 18 C	K3.2 ▧ 14 C	K5.1 ▧ 14 C	K5.2 ▧ 10 C	N1.1 ▧ 40 G	N1.2 ■ 30 G	N1.3 ▧ 20 F	N2.1 ■ 20 F	N2.2 ▧ 18 F
N3.1 ■ 21 F	N3.2 ■ 12 F	N3.3 ▧ 16 D	N4.1 ▧ 40 G	N4.2 ▧ 35 G									

DCON MS tolerancia h9.

Product	DC_2 (mm)	DC_1 (mm)	LCF (mm)	OAL (mm)	DCON MS (mm)	NOF
G1546.3	6.30	1.50	5.5	45.0	5.00	3
G1548.3	8.30	2.00	6.5	50.0	6.00	3
G15410.4	10.40	2.50	7.6	50.0	6.00	3
G15412.4	12.40	2.80	8.5	56.0	8.00	3
G15416.5	16.50	3.20	10.5	60.0	10.00	3
G15420.5	20.50	3.50	13.0	63.0	10.00	3
G15425.0	25.00	3.80	15.5	67.0	10.00	3

G129



Avellanador HSS a 90°, con un Solo Canal, Mango Cilíndrico, con Acabado Brillante

Avellanador de 90° diseñado para achaflanar y para eliminar rebabas en agujeros taladrados. El diseño de un solo filo reduce vibraciones para proporcionar una operación de achaflanado suave. Adecuado para achaflanar agujeros en aceros de bajo contenido en carbono y materiales no férreos de resistencia media, como el aluminio.

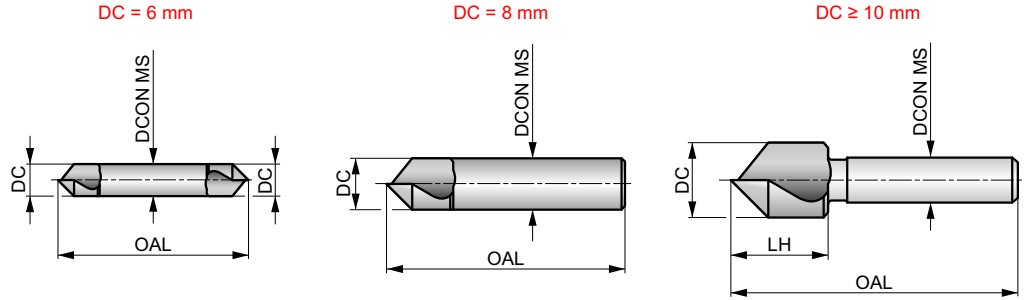

HSS	Bright	DORMER
R		90°

Grupo de Material de la pieza adecuado y condiciones de velocidad de corte iniciales (m/min) y código de avance alfabético. Tablas con avance por revolución a partir de la pag.280.

P1.1 ■ 21 D	P1.2 ■ 24 D	P1.3 ■ 25 D	P2.1 ■ 18 D	P2.2 ■ 16 C	P2.3 ■ 14 A	P3.1 ■ 13 B	P3.2 ■ 11 B	M1.1 ■ 8 B	M1.2 ■ 6 B	M2.1 ■ 7 B	K1.1 ■ 18 D	K1.2 ■ 13 C	K2.1 ■ 19 A
K2.2 ■ 15 A	K3.1 ■ 16 A	K3.2 ■ 12 A	N1.1 ■ 34 D	N1.2 ■ 25 D	N1.3 ■ 16 C	N2.1 ■ 16 C	N2.2 ■ 14 C	N3.1 ■ 17 C	N3.2 ■ 9 C	N3.3 ■ 5 B	N4.1 ■ 35 D	N4.2 ■ 30 D	

DCON MS tolerancia h9.

Product	DC (mm)	LH (mm)	OAL (mm)	DCON MS (mm)	NOF
G1296.0	6.00	–	45.0	6.00	1
G1298.0	8.00	–	50.0	8.00	1
G12910.0	10.00	17.0	49.0	8.00	1
G12912.5	12.50	17.0	49.0	8.00	1
G12916.0	16.00	20.0	56.0	10.00	1
G12920.0	20.00	24.0	60.0	10.00	1
G12925.0	25.00	25.0	75.0	12.00	1
G12931.5	31.50	29.0	80.0	12.00	1

G132

DORMER



Avellanador HSS a 90°, Multi Canales, Acabado Brillante

Avellanador de 90° diseñado para achaflanar agujeros para tornillos estándar y para eliminar rebabas en agujeros taladrados. Múltiples dientes para reducir vibraciones, lo que proporciona una operación de achaflanado suave. Herramienta versátil para su uso en aplicaciones manuales y en máquinas. Adecuado para achaflanar agujeros en la mayoría de materiales.

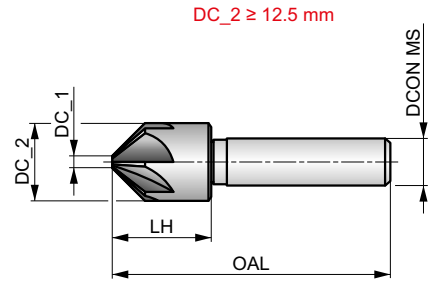
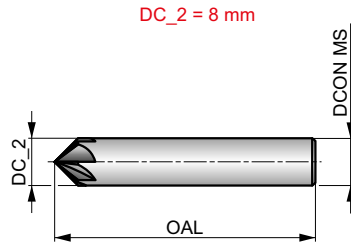

HSS	Bright	DIN 335A
R		90°

Grupo de Material de la pieza adecuado y condiciones de velocidad de corte iniciales (m/min) y código de avance alfabético. Tablas con avance por revolución a partir de la pag.280.

P2.2 ■ 18 E	P2.3 ■ 16 D	P3.2 ■ 13 D	P3.3 ■ 11 B	P4.1 ■ 10 D	P4.2 ■ 8 C	P4.3 ■ 7 B	M3.3 ■ 3 A	M4.1 ■ 4 A	K1.1 ■ 20 F	K1.2 ■ 15 D	K1.3 ■ 11 D	K2.2 ■ 17 C	K2.3 ■ 14 D
K3.1 ■ 18 E	K3.2 ■ 14 E	K3.3 ■ 11 D	K4.1 ■ 17 C	K4.2 ■ 13 C	K5.1 ■ 19	K5.2 ■ 15	K5.3 ■ 11 D	N1.3 ■ 20 F	N2.3 ■ 13 F	N3.2 ■ 12 F	N4.3 ■ 5 G		

DCON MS tolerancia h9.

Product	DC_2 (mm)	DC_1 (mm)	LH (mm)	OAL (mm)	DCON MS (mm)	NOF
G1328.0	8.00	—	—	48.0	8.00	5
G13212.5	12.50	2.00	15.5	48.0	8.00	5
G13216.0	16.00	3.20	19.5	56.0	10.00	7
G13220.0	20.00	5.00	23.0	60.0	10.00	7

B690



Escariador central HSS de mango recto, ángulos de avellanado de 60°, 82°, 90° ó 100

Se utiliza principalmente para escariar agujeros taladrados en el centro, agujeros en el centro de ejes en tornos y ángulos de avellanado para cabezas de tornillos y remaches. Disponible en ángulos de avellanado de 60°, 82°, 90° ó 100°. El número desigal de estrías favorece acabados lisos eliminando las vibraciones y mejorando la precisión.

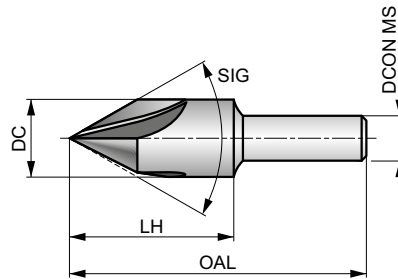

HSS	Bright	ANSI
R		60-100°

Grupo de Material de la pieza adecuado y condiciones de velocidad de corte iniciales (m/min) y código de avance alfabético. Tablas con avance por revolución a partir de la pag.280.

P1.1 ■ 21 D	P1.2 ■ 24 D	P1.3 ■ 25 D	P2.1 ■ 18 D	P2.2 ■ 16 C	P2.3 ▣ 14 A	P3.1 ■ 13 B	P3.2 ▣ 11 B	M1.1 ▣ 8 B	M1.2 ▣ 6 B	M2.1 ▣ 7 B	K1.1 ▣ 18 D	K1.2 ▣ 13 C	K2.1 ▣ 19 A
K2.2 ▣ 15 A	K3.1 ▣ 16 A	K3.2 ▣ 12 A	N1.1 ■ 34 D	N1.2 ■ 25 D	N1.3 ■ 16 C	N2.1 ▣ 16 C	N2.2 ▣ 14 C	N3.1 ■ 17 C	N3.2 ■ 9 C	N3.3 ▣ 5 B	N4.1 ▣ 35 D	N4.2 ▣ 30 D	

Product	DC (inch)	DC (inch)	SIG (°)	DCON MS (inch)	OAL (inch)	NOF
B6901/4X60	1/4	0.2500	60	3/16	1.1/2	3
B6901/4X82	1/4	0.2500	82	3/16	1.1/2	3
B6901/4X90	1/4	0.2500	90	3/16	1.1/2	3
B6901/4X100	1/4	0.2500	100	3/16	1.1/2	3
B6903/8X60	3/8	0.3750	60	1/4	1.3/4	3
B6903/8X82	3/8	0.3750	82	1/4	1.3/4	3
B6903/8X90	3/8	0.3750	90	1/4	1.3/4	3
B6903/8X100	3/8	0.3750	100	1/4	1.3/4	3
B6901/2X60	1/2	0.5000	60	3/8	2"	3
B6901/2X82	1/2	0.5000	82	3/8	2"	3
B6901/2X90	1/2	0.5000	90	3/8	2"	3
B6901/2X100	1/2	0.5000	100	3/8	2"	3

Product	DC (inch)	DC (inch)	SIG (°)	DCON MS (inch)	OAL (inch)	NOF
B6905/8X60	5/8	0.6250	60	3/8	2.1/4	3
B6905/8X82	5/8	0.6250	82	3/8	2.1/4	3
B6905/8X90	5/8	0.6250	90	3/8	2.1/4	3
B6905/8X100	5/8	0.6250	100	3/8	2.1/4	3
B6903/4X60	3/4	0.7500	60	1/2	2.5/8	3
B6903/4X82	3/4	0.7500	82	1/2	2.5/8	3
B6903/4X90	3/4	0.7500	90	1/2	2.5/8	3
B6903/4X100	3/4	0.7500	100	1/2	2.5/8	3
B6901X60	1"	1.0000	60	1/2	3"	3
B6901X82	1"	1.0000	82	1/2	3"	3
B6901X90	1"	1.0000	90	1/2	3"	3
B6901X100	1"	1.0000	100	1/2	3"	3

G142



Avellanador HSS a 90°, Mango Cilíndrico, con Acabado Brillante, para Acero Inoxidable.

Avellanador de 90° diseñado para achaflanar agujeros para tornillos estándar y para eliminar rebabas en agujeros taladrados. Mayor relieve para proporcionar un filo de corte más afilado, lo que mejora el rendimiento al mecanizar materiales pegajosos, como aceros inoxidables y materiales no féreos. Se puede utilizar en aplicaciones manuales y en máquinas.

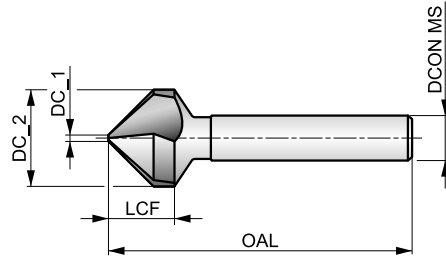

HSS	Bright	DIN 335C
R		90°

Grupo de Material de la pieza adecuado y condiciones de velocidad de corte iniciales (m/min) y código de avance alfabético. Tablas con avance por revolución a partir de la pag.280.

P1.1 ■ 23 E	P1.2 ■ 26 E	P1.3 ■ 27 E	P2.1 ■ 20 E	P2.2 ■ 18 D	P2.3 ■ 16 B	P3.1 ■ 16 D	P3.2 ■ 13 D	P3.3 ■ 11 B	P4.1 ■ 10 D	P4.2 ■ 8 B	M1.1 ■ 11 C	M1.2 ■ 9 C	M2.1 ■ 10 C
M2.2 ■ 8 C	M3.1 ■ 7 B	M3.2 ■ 6 B	M4.1 ■ 4 A	N1.1 ■ 40 G	N1.2 ■ 30 G	N1.3 ■ 20 F	N2.1 ■ 20 F	N2.2 ■ 18 F	N2.3 ■ 20 F	N3.1 ■ 34 F	N3.2 ■ 20 F	N3.3 ■ 10 D	N4.1 ■ 40 G
N4.2 ■ 35 G													

DCON MS tolerancia h9.

Product	DC_2 (mm)	DC_1 (mm)	LCF (mm)	OAL (mm)	DCON MS (mm)	NOF
G1425.0	5.00	1.50	4.5	40.0	4.00	3
G1426.3	6.30	1.50	5.5	45.0	5.00	3
G1428.0	8.00	2.00	6.1	50.0	6.00	3
G1428.3	8.30	2.00	6.5	50.0	6.00	3
G14210.0	10.00	2.50	7.6	50.0	6.00	3
G14210.4	10.40	2.50	7.6	50.0	6.00	3
G14212.4	12.40	2.80	8.5	56.0	8.00	3
G14215.0	15.00	3.20	9.5	60.0	10.00	3
G14216.5	16.50	3.20	10.5	60.0	10.00	3
G14220.5	20.50	3.50	13.0	63.0	10.00	3
G14223.0	23.00	3.80	13.7	67.0	10.00	3
G14225.0	25.00	3.80	15.5	67.0	10.00	3
G14231.0	31.00	4.20	18.5	71.0	12.00	3

G136



Avellanador HSS a 90°, Mango Cilíndrico, con Acabado Brillante

Avellanador de 90° diseñado para achaflanar agujeros y para eliminar rebabas en agujeros taladrados. El mango reducido permite avellanados de mayor diámetro en portaherramientas y portabrocas estándar. Herramienta versátil, que se puede utilizar en aplicaciones manuales y en máquinas. Adecuado para achaflanar agujeros en la mayoría de materiales.

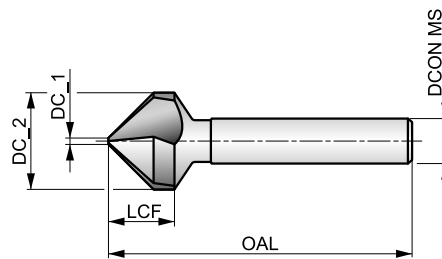

HSS	Bright	DIN 335C
R		90°

Grupo de Material de la pieza adecuado y condiciones de velocidad de corte iniciales (m/min) y código de avance alfabético. Tablas con avance por revolución a partir de la pag.280.

P1.1 ■ 23 E	P1.2 ■ 26 E	P1.3 ■ 27 E	P2.1 ■ 20 E	P2.2 ■ 18 D	P2.3 ■ 16 B	P3.1 ■ 16 D	P3.2 ■ 13 D	P3.3 ■ 11 B	P4.1 ■ 10 D	P4.2 ■ 8 B	M1.1 ■ 8 C	M1.2 ■ 16 C	M2.1 ■ 7 C
M2.2 ■ 6 C	K1.1 ■ 20 F	K1.2 ■ 15 D	K2.1 ■ 21 C	K2.2 ■ 17 C	K3.1 ■ 18 C	K3.2 ■ 14 C	K5.1 ■ 19 C	K5.2 ■ 15 C	N1.1 ■ 40 G	N1.2 ■ 30 G	N1.3 ■ 20 F	N2.1 ■ 20 F	N2.2 ■ 18 F
N3.1 ■ 21 F	N3.2 ■ 12 F	N3.3 ■ 16 D	N4.1 ■ 40 G	N4.2 ■ 35 G									

DCON MS tolerancia h9.
Los productos de esta serie también están disponibles en forma de Set. Por favor, vea G236.

Product	DC_2	DC_1	LCF	OAL	DCON MS	NOF
	(mm)	(mm)	(mm)	(mm)	(mm)	
G1364.3	4.30	1.30	4.0	40.0	4.00	3
G1365.0	5.00	1.50	4.5	40.0	4.00	3
G1365.3	5.30	1.50	4.5	40.0	4.00	3
G1365.8	5.80	1.50	5.0	45.0	5.00	3
G1366.0	6.00	1.50	5.0	45.0	5.00	3
G1366.3	6.30	1.50	5.5	45.0	5.00	3
G1367.0	7.00	1.80	5.5	50.0	6.00	3
G1367.3	7.30	1.80	6.1	50.0	6.00	3
G1368.0	8.00	2.00	6.1	50.0	6.00	3
G1368.3	8.30	2.00	6.5	50.0	6.00	3
G1369.4	9.40	2.20	7.2	50.0	6.00	3
G13610.0	10.00	2.50	7.6	50.0	6.00	3
G13610.4	10.40	2.50	7.6	50.0	6.00	3

Product	DC_2	DC_1	LCF	OAL	DCON MS	NOF
	(mm)	(mm)	(mm)	(mm)	(mm)	
G13611.5	11.50	2.80	8.0	56.0	8.00	3
G13612.4	12.40	2.80	8.5	56.0	8.00	3
G13613.4	13.40	2.90	9.0	56.0	8.00	3
G13615.0	15.00	3.20	9.5	60.0	10.00	3
G13616.5	16.50	3.20	10.5	60.0	10.00	3
G13619.0	19.00	3.50	11.7	63.0	10.00	3
G13620.5	20.50	3.50	13.0	63.0	10.00	3
G13623.0	23.00	3.80	13.7	67.0	10.00	3
G13625.0	25.00	3.80	15.5	67.0	10.00	3
G13626.0	26.00	3.80	15.5	67.0	10.00	3
G13628.0	28.00	4.00	16.5	71.0	12.00	3
G13630.0	30.00	4.20	18.5	71.0	12.00	3
G13631.0	31.00	4.20	18.5	71.0	12.00	3

G106



Avellanador HSS a 90°, Mango a Tres Planos, con Acabado Brillante

Avellanador de 90° diseñado para achaflanar agujeros para tornillos estándar y para eliminar rebabas en agujeros taladrados. El mango con tres planos de apriete mejora el amarre en portabrocas de tres garras. Adecuado para achaflanar agujeros en la mayoría de materiales.

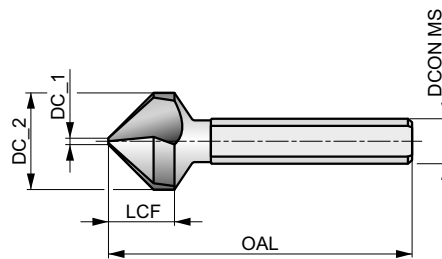

HSS	Bright	DIN 335C
R		90°

Grupo de Material de la pieza adecuado y condiciones de velocidad de corte iniciales (m/min) y código de avance alfabético. Tablas con avance por revolución a partir de la pag.280.

P1.1 ■ 23 E	P1.2 ■ 26 E	P1.3 ■ 27 E	P2.1 ■ 20 E	P2.2 ■ 18 D	P2.3 ▣ 16 B	P3.1 ■ 16 D	P3.2 ■ 13 D	P3.3 ▣ 11 B	P4.1 ■ 10 D	P4.2 ▣ 8 B	M1.1 ▣ 8 C	M1.2 ▣ 16 C	M2.1 ▣ 17 C
M2.2 ▣ 6 C	K1.1 ■ 20 F	K1.2 ■ 15 D	K2.1 ▣ 21 C	K2.2 ▣ 17 C	K3.1 ▣ 18 C	K3.2 ▣ 14 C	K5.1 ▣ 19 C	K5.2 ▣ 15 C	N1.1 ▣ 40 G	N1.2 ■ 30 G	N1.3 ▣ 20 F	N2.1 ▣ 20 F	N2.2 ▣ 18 F
N3.1 ■ 21 F	N3.2 ▣ 12 F	N3.3 ▣ 16 D	N4.1 ▣ 40 G	N4.2 ▣ 35 G									

DCON MS tolerancia h9.
Los productos de esta serie también están disponibles en forma de Set. Por favor, vea G236.

Product	DC_2 (mm)	DC_1 (mm)	LCF (mm)	OAL (mm)	DCON MS (mm)	NOF
G1066.3	6.30	1.50	5.6	45.0	5.00	3
G1068.3	8.30	2.00	6.9	50.0	6.00	3
G10610.4	10.40	2.50	7.8	50.0	6.00	3
G10612.4	12.40	2.80	8.6	56.0	8.00	3
G10616.5	16.50	3.20	11.1	60.0	10.00	3
G10620.5	20.50	3.50	12.9	63.0	10.00	3
G10625.0	25.00	3.80	15.7	67.0	10.00	3
G10631.0	31.00	4.20	18.5	71.0	12.00	3
G10634.0	34.00	4.50	19.0	103.0	16.00	3
G10637.0	37.00	4.50	21.2	118.0	16.00	3
G10640.0	40.00	4.50	20.0	118.0	16.00	3
G10650.0	50.00	5.00	23.6	126.0	16.00	3

G506



Avellanador HSS a 90°, Mango a Tres Planos, con Recubrimiento TiAlN

Avellanador de 90° diseñado para achaflanar agujeros para tornillos estándar y para eliminar rebabas en agujeros taladrados. El mango con tres planos de apriete mejora el amarre en portabrocas de tres garras, especialmente en máquinas de mano. El recubrimiento TiAlN prolonga la vida útil de la herramienta. Adecuado para achaflanar agujeros en la mayoría de materiales.

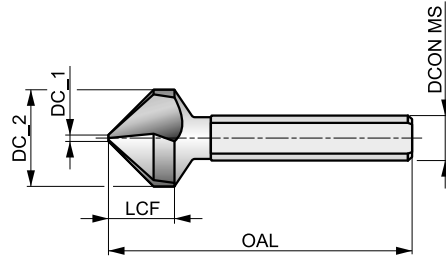

HSS	TiAlN	DIN 335C
R		90°

Grupo de Material de la pieza adecuado y condiciones de velocidad de corte iniciales (m/min) y código de avance alfabético. Tablas con avance por revolución a partir de la pag.280.

P1.1 ■ 40 E	P1.2 ■ 45 E	P1.3 ■ 46 E	P2.1 ■ 34 E	P2.2 ■ 30 D	P2.3 ■ 27 B	P3.1 ■ 28 D	P3.2 ■ 22 D	P3.3 ■ 19 B	P4.1 ■ 16 D	P4.2 ■ 14 B	P4.3 ▣ 11 B	M1.1 ▣ 11 C	M1.2 ▣ 9 C
M2.1 ▣ 10 C	M2.2 ▣ 9 C	M2.3 ▣ 8 B	K1.1 ■ 41 F	K1.2 ■ 30 D	K1.3 ▣ 23 D	K2.1 ■ 42 C	K2.2 ■ 34 C	K2.3 ▣ 27 C	K3.1 ■ 37 C	K3.2 ■ 28 C	K3.3 ▣ 23 C	K4.1 ▣ 34 C	K4.2 ▣ 26 C
K4.3 ▣ 19 C	K5.1 ■ 39 C	K5.2 ■ 29 C	K5.3 ▣ 23 C	N1.1 ▣ 60 G	N1.2 ▣ 45 G	N1.3 ■ 30 F	N2.1 ■ 30 F	N2.2 ■ 27 F	N2.3 ■ 19 F	N3.1 ■ 32 F	N3.2 ■ 18 F	N3.3 ▣ 19 D	N4.1 ▣ 62 G
N4.2 ▣ 55 G													

DCON MS tolerancia h9.
Los productos de esta serie también están disponibles en forma de Set. Por favor, vea G236.

Product	DC_2 (mm)	DC_1 (mm)	LCF (mm)	OAL (mm)	DCON MS (mm)	NOF
G5066.3	6.30	1.50	5.6	45.0	5.00	3
G5068.3	8.30	2.00	6.9	50.0	6.00	3
G50610.4	10.40	2.50	7.8	50.0	6.00	3
G50612.4	12.40	2.80	8.6	56.0	8.00	3
G50616.5	16.50	3.20	11.1	60.0	10.00	3
G50620.5	20.50	3.50	12.9	63.0	10.00	3
G50625.0	25.00	3.80	15.7	67.0	10.00	3
G50631.0	31.00	4.20	18.5	71.0	12.00	3
G50637.0	37.00	4.50	21.2	118.0	16.00	3
G50640.0	40.00	4.50	20.0	118.0	16.00	3
G50650.0	50.00	5.00	23.6	126.0	16.00	3

G107



Avellanador HSS-E 90°, con Mango Hexagonal, Acabado Brillante

Avellanador versátil con mango hexagonal que facilita su fijación en adaptadores para destornilladores eléctricos. El avellanador a 90° produce chaflanes en agujeros para tornillos estándar y elimina rebabas en agujeros taladrados. Adecuado para achaflanar agujeros en la mayoría de materiales.

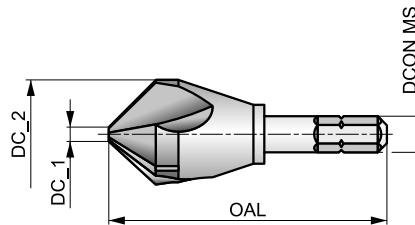

HSS-E	Bright	DORMER
R		90°

Grupo de Material de la pieza adecuado y condiciones de velocidad de corte iniciales (m/min) y código de avance alfabético. Tablas con avance por revolución a partir de la pag.280.

P1.1 ■ 23 E	P1.2 ■ 26 E	P1.3 ■ 27 E	P2.1 ■ 20 E	P2.2 ■ 18 D	P2.3 ▣ 16 B	P3.1 ■ 16 D	P3.2 ■ 13 D	P3.3 ▣ 11 B	P4.1 ■ 10 D	P4.2 ▣ 8 B	M1.1 ▣ 11 C	M1.2 ▣ 9 C	M2.1 ▣ 10 C
M2.2 ▣ 9 C	M2.3 ▣ 8 B	K1.1 ■ 20 F	K1.2 ▣ 15 D	K2.1 ■ 21 C	K2.2 ▣ 17 C	K3.1 ■ 18 C	K3.2 ▣ 14 C	K4.1 ▣ 15 C	K5.1 ■ 19 C	K5.2 ▣ 15 C	N1.1 ▣ 40 G	N1.2 ■ 30 G	N1.3 ▣ 20 F
N2.1 ▣ 20 F	N2.2 ▣ 18 F	N2.3 ▣ 20 F	N3.1 ■ 21 F	N3.2 ▣ 12 F	N3.3 ▣ 6 D	N4.1 ▣ 40 G	N4.2 ▣ 35 G						

6.35; 1/4" mango hexagonal; DIN 74.

Product	DC_2	DC_1	OAL	DCON MS	CZC MS	NOF
	(mm)	(mm)	(mm)	(inch)		
G1076.3	6.30	1.50	50.0	1/4"	M2-M3	3
G10710.4	10.40	2.50	50.0	1/4"	M5	3
G10712.4	12.40	2.80	50.0	1/4"	M6	3
G10716.5	16.50	3.20	50.0	1/4"	M8	3
G10720.5	20.50	3.50	50.0	1/4"	M10	3

G600



Avellanador HSS a 90°, Mango Cilíndrico Extra Largo, Acabado Brillante

El mango extra largo permite achaflanar agujeros en áreas de difícil acceso. El avellanado a 90° produce chaflanes para tornillos estándar y limpia las rebabas de los agujeros taladrados. Adecuado para achaflanar agujeros en muchos materiales.

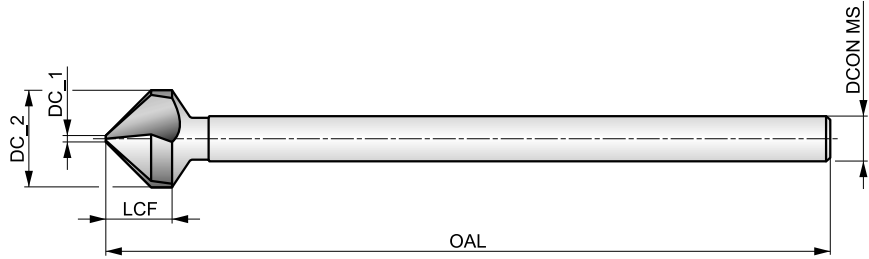

HSS	Bright	DORMER
R		90°

Grupo de Material de la pieza adecuado y condiciones de velocidad de corte iniciales (m/min) y código de avance alfabético. Tablas con avance por revolución a partir de la pag.280.

P1.1 ■ 20 E	P1.2 ■ 22 E	P1.3 ■ 23 E	P2.1 ■ 17 E	P2.2 ■ 15 D	P2.3 ▣ 13 B	P3.1 ■ 12 D	P3.2 ■ 9 D	P3.3 ▣ 8 B	P4.1 ■ 7 D	P4.2 ▣ 6 B	M1.1 ▣ 8 C	M1.2 ▣ 6 C	M2.1 ▣ 7 C
M2.2 ▣ 6 C	K1.1 ■ 17 E	K1.2 ▣ 12 C	K2.1 ▣ 18 B	K2.2 ▣ 14 B	K3.1 ▣ 15 B	K3.2 ▣ 11 B	K5.1 ▣ 16 B	K5.2 ▣ 12 B	N1.1 ▣ 35 G	N1.2 ▣ 25 G	N1.3 ▣ 15 F	N2.1 ▣ 15 F	N2.2 ▣ 13 F
N3.1 ■ 16 E	N3.2 ▣ 10 E	N3.3 ▣ 5 C											

DCON MS tolerancia h9.

Product	DC_2 (mm)	DC_1 (mm)	LCF (mm)	OAL (mm)	DCON MS (mm)	NOF
G6006.3	6.30	1.30	5.6	154.0	5.00	3
G6008.3	8.30	1.80	6.9	155.0	6.00	3
G60010.4	10.40	2.20	7.8	157.0	6.00	3
G60012.4	12.40	2.50	8.6	158.0	8.00	3
G60015.0	15.00	2.80	10.3	159.0	10.00	3
G60016.5	16.50	2.80	11.1	161.0	10.00	3
G60020.5	20.50	3.00	12.9	164.0	10.00	3
G60025.0	25.00	3.20	15.7	168.0	10.00	3

G236



Juego de Avellanadores en Caja de Plástico Cilíndrica

Juegos que contienen varios tamaños de avellanadores a 90°. Hay 5 juegos diferentes con G106, G136 o G560 disponibles. Adecuados para muchos materiales.

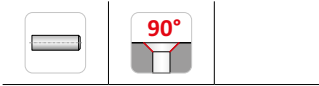

A=Tipos en el Juego, B=No en el Juego, C=Diámetros en el Juego.

Product	Nr.	A	B	C
G2361	1	G136	6	6.30 mm, 8.30 mm, 10.40 mm, 12.40 mm, 16.50 mm, 20.50 mm
G2362	2	G136	4	6.30 mm, 10.40 mm, 16.50 mm, 20.50 mm
G2363	3	G560	6	6.30 mm, 8.30 mm, 10.40 mm, 12.40 mm, 16.50 mm, 20.50 mm
G2364	4	G106	6	6.30 mm, 8.30 mm, 10.40 mm, 12.40 mm, 16.50 mm, 20.50 mm
G2365	5	G506	6	6.30 mm, 8.30 mm, 10.40 mm, 12.40 mm, 16.50 mm, 20.50 mm

Código de Material (BMC)	HSS	HSS	HSS	HSS	HSS	HSS-E	HSS	HSS	HSS	HSS	HSS	HSS	HSS
Recubrimiento	Bright ST	Bright	Bright	Bright	Bright ST	Bright	Bright ST	Bright	Bright	Bright	Bright	Bright	ST Bronze
Grupo básico estándar (BSG)	DIN 206	ANSI	ANSI	ANSI	BS 328	DIN 2179	DIN 9	DIN 9	ANSI	ANSI	ANSI	ANSI	ANSI
Mano (dirección de corte)	R	R	R	R	R	R	R	R	R	R	R	R	R
Mango													
Forma del Escariador	B				A		A	B					
Tolerancia del agujero alcanzable (TCHA)	H7												
Gradiente cónico (tasa de cónico) - milímetros (TG)					1:48	1:50	1:50	1:50	1:48	1:48	1:48		



Código de Familia de Producto	B100	B610	B620	B650	B301	B953	B903	B952	B630	B660	B670	B680	B122
Gama de diámetros de corte PSF	1.50 - 40.00	N60 - 1.1/2	1/16 - 1"	1/8 - 1"	3/32 - 1/2	2.00 - 12.00	1.50 - 20.00	1.20 - 40.00	7/0 - N10	N0 - N10	N0 - N10	1/8 - 1"	3/8 - 1"

P	P1	■	■	■	■	■	■	■	■	■	■	■	■
	P2	■	■	■	■	■	■	■	■	■	■	■	■
	P3	▣	■	■	■	■	▣	■	■	■	■	■	▣
	P4	▣	■	■	▣	▣	▣	▣	▣	▣	▣	▣	▣
M	M1	▣	▣	▣	▣	▣	▣	▣	▣	▣	▣	▣	▣
	M2	▣	▣	▣	▣	▣	▣	▣	▣	▣	▣	▣	▣
	M3												
	M4												
K	K1	■	■	■	■	■	▣	▣	■	■	■	■	
	K2	▣	■	■	■	■	■	■	■	■	■	■	
	K3	■	▣	▣	■	▣	▣	▣	■	■	■	■	
	K4												
	K5												
N	N1	■	▣	■	■	■	▣	■	■	■	■	■	▣
	N2	■	▣	■	■	■	■	■	■	■	■	■	▣
	N3	■	■	■	■	■	▣	■	■	■	■	■	■
	N4	▣	▣		▣	▣	▣	▣	▣	▣	▣	▣	▣
	N5												
S	S1												
	S2												
	S3												
	S4												
H	H1												
	H2												
	H3												
	H4												

B100



Escariador HSS, Mango Cilíndrico, Tolerancia H7, Acabado Brillante/Templado al Vapor

Diseñado principalmente para escariar a mano. Tiene una hélice a izquierda rectificada con precisión y corte a derecha (en el sentido de las agujas del reloj) para un escariado suave, creando un agujero más preciso y un buen acabado superficial. Adecuado para escariar muchos materiales, incluidos aceros.

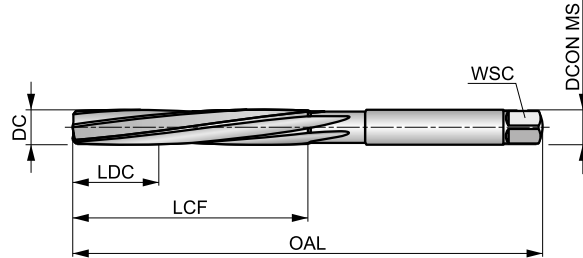

HSS	Bright ST	DIN 206
R		B
H7		

Grupo de Material de la pieza.

P1.1	P1.2	P1.3	P2.1	P2.2	P2.3	P3.1	P3.2	P3.3	P4.1	P4.2	P4.3	M1.1	M1.2
■	■	■	■	■	■	■	■	■	■	■	■	■	■
M2.1	K1.1	K1.2	K1.3	K2.1	K2.2	K2.3	K3.1	K3.2	N1.1	N1.2	N1.3	N2.1	N2.2
■	■	■	■	■	■	■	■	■	■	■	■	■	■
N2.3	N3.1	N3.2	N3.3	N4.1	N4.2								
■	■	■	■	■	■								

DCON MS tolerancia e9.

Product	DC (inch)	DC (mm)	OAL (mm)	LCF (mm)	LDC (mm)	NOF	WSC (mm)	DCON MS (mm)
B1001.5	—	1.50	41.0	20.0	5.00	3	1.12	1.50
B1002.0	—	2.00	50.0	25.0	6.00	4	1.60	2.00
B1003/32	3/32	2.38	54.0	27.0	7.00	4	1.80	2.38
B1002.5	—	2.50	58.0	29.0	7.00	4	2.10	2.50
B1003.0	—	3.00	62.0	31.0	8.00	6	2.40	3.00
B1001/8	1/8	3.18	66.0	33.0	8.00	6	2.40	3.18
B1003.2	—	3.20	66.0	33.0	8.00	6	2.40	3.20
B1003.5	—	3.50	71.0	35.0	9.00	6	2.70	3.50
B1005/32	5/32	3.97	76.0	38.0	10.00	6	3.00	3.97
B1004.0	—	4.00	76.0	38.0	10.00	6	3.00	4.00
B1004.5	—	4.50	81.0	41.0	10.00	6	3.40	4.50
B1003/16	3/16	4.76	87.0	44.0	11.00	6	3.80	4.76
B1005.0	—	5.00	87.0	44.0	11.00	6	3.80	5.00
B1005.5	—	5.50	93.0	47.0	12.00	6	4.30	5.50
B1007/32	7/32	5.56	93.0	47.0	12.00	6	4.30	5.56
B1006.0	—	6.00	93.0	47.0	12.00	6	4.90	6.00
B1001/4	1/4	6.35	100.0	50.0	13.00	6	4.90	6.35
B1006.5	—	6.50	100.0	50.0	13.00	6	4.90	6.50
B10017/64	17/64	6.75	107.0	54.0	14.00	6	5.50	6.75
B1007.0	—	7.00	107.0	54.0	14.00	6	5.50	7.00
B1009/32	9/32	7.14	107.0	54.0	14.00	6	6.20	7.14
B1007.5	—	7.50	107.0	54.0	14.00	6	6.20	7.50
B1005/16	5/16	7.94	115.0	58.0	15.00	6	6.20	7.94
B1008.0	—	8.00	115.0	58.0	15.00	6	6.20	8.00
B10021/64	21/64	8.33	115.0	58.0	15.00	6	7.00	8.33
B1008.5	—	8.50	115.0	58.0	15.00	6	7.00	8.50
B10011/32	11/32	8.73	124.0	62.0	16.00	6	7.00	8.73

Product	DC	DC	OAL	LCF	LDC	NOF	WSC	DCON MS
	(inch)	(mm)	(mm)	(mm)	(mm)		(mm)	(mm)
B1009.0	–	9.00	124.0	62.0	16.00	6	7.00	9.00
B1009.5	–	9.50	124.0	62.0	16.00	6	8.00	9.50
B1003/8	3/8	9.52	124.0	62.0	17.00	6	8.00	9.52
B10010.0	–	10.00	133.0	66.0	17.00	6	8.00	10.00
B10013/32	13/32	10.32	133.0	66.0	17.00	6	8.00	10.32
B10010.5	–	10.50	133.0	66.0	17.00	6	8.00	10.50
B10011.0	–	11.00	142.0	71.0	18.00	6	9.00	11.00
B1007/16	7/16	11.11	142.0	71.0	18.00	6	9.00	11.11
B10011.5	–	11.50	142.0	71.0	18.00	6	9.00	11.50
B10012.0	–	12.00	152.0	76.0	19.00	6	9.00	12.00
B10012.5	–	12.50	152.0	76.0	19.00	6	10.00	12.50
B1001/2	1/2	12.70	152.0	76.0	19.00	6	10.00	12.70
B10013.0	–	13.00	152.0	76.0	19.00	6	10.00	13.00
B10013.5	–	13.50	163.0	81.0	20.00	8	11.00	13.50
B10014.0	–	14.00	163.0	81.0	20.00	8	11.00	14.00
B1009/16	9/16	14.29	163.0	81.0	20.00	8	11.00	14.29
B10014.5	–	14.50	163.0	81.0	20.00	8	11.00	14.50
B10015.0	–	15.00	163.0	81.0	20.00	8	12.00	15.00
B1005/8	5/8	15.88	175.0	87.0	22.00	8	12.00	15.88
B10016.0	–	16.00	175.0	87.0	22.00	8	12.00	16.00
B10017.0	–	17.00	175.0	87.0	22.00	8	13.00	17.00
B10018.0	–	18.00	188.0	93.0	23.00	8	14.50	18.00
B10019.0	–	19.00	188.0	93.0	23.00	8	14.50	19.00
B1003/4	3/4	19.05	188.0	93.0	25.00	8	14.50	19.05
B10020.0	–	20.00	201.0	100.0	25.00	8	16.00	20.00
B10021.0	–	21.00	201.0	100.0	25.00	8	16.00	21.00
B10022.0	–	22.00	215.0	107.0	27.00	8	18.00	22.00
B1007/8	7/8	22.22	215.0	107.0	27.00	8	18.00	22.22
B10023.0	–	23.00	215.0	107.0	27.00	8	18.00	23.00
B10024.0	–	24.00	231.0	115.0	29.00	8	18.00	24.00
B10025.0	–	25.00	231.0	115.0	29.00	8	20.00	25.00
B1001	1"	25.40	231.0	115.0	29.00	8	20.00	25.40
B10026.0	–	26.00	231.0	115.0	29.00	8	20.00	26.00
B10028.0	–	28.00	247.0	124.0	31.00	10	22.00	28.00
B10030.0	–	30.00	247.0	124.0	31.00	10	24.00	30.00
B10032.0	–	32.00	265.0	133.0	33.00	10	24.00	32.00
B10035.0	–	35.00	284.0	142.0	36.00	10	29.00	35.00
B10040.0	–	40.00	305.0	152.0	38.00	10	32.00	40.00

B610



Escariador de máquina HSS de mango cilíndrico y filos rectos, acabado brillante

Los versátiles escariadores de máquina de uso general tienen canales rectos más cortos y profundos que los escariadores manuales y están diseñados para un escariado en máquina eficaz en la mayoría de los materiales. Disponibles en una amplia gama de tamaños, incluyendo fraccionales, calibre de alambre, letras y tamaños decimales incrementales. Fabricados según ANSI B94.2-1983 (R1988).

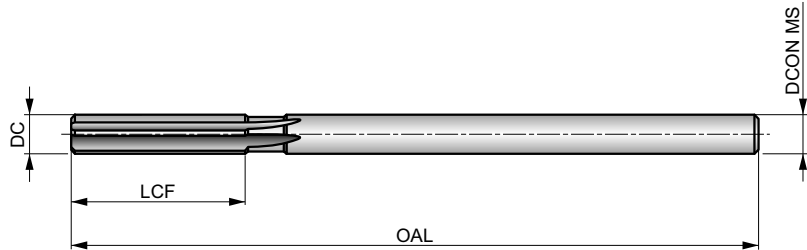

HSS	Bright	ANSI
R		

Grupo de Material de la pieza adecuado y condiciones de velocidad de corte iniciales (m/min) y código de avance alfabético. Tablas con avance por revolución a partir de la pag.279.

P1.1 19 C	P1.2 22 C	P1.3 23 C	P2.1 16 C	P2.2 14 C	P2.3 12 B	P3.1 11 B	P3.2 9 B	P3.3 7 A	P4.1 5 B	P4.2 4 A	P4.3 3	M1.1 9 C	M1.2 8 B
M2.1 7 B	K1.1 14 E	K1.2 10 D	K1.3 7 D	K2.1 14 C	K2.2 11 C	K2.3 9 C	K3.1 12 C	K3.2 9 C	N1.1 22 F	N1.2 16 F	N1.3 9 F	N2.1 25 E	N2.2 22 E
N2.3 14 E	N3.1 45 D	N3.2 26 E	N3.3 12 D	N4.1 28 B									

Product	DC (inch)	DC (Wire gauge size)	DC (inch)	DCON MS (inch)	LCF (inch)	OAL (inch)	NOF
B610N60	—	N60	0.0400	0.039	1/2	2.1/2	4
B610N59	—	N59	0.0410	0.039	1/2	2.1/2	4
B610N58	—	N58	0.0420	0.039	1/2	2.1/2	4
B610N57	—	N57	0.0430	0.039	1/2	2.1/2	4
B610N56	—	N56	0.0465	0.045	1/2	2.1/2	4
B6103/64	3/64	—	0.0469	0.045	1/2	2.1/2	4
B610N55	—	N55	0.0520	0.051	1/2	2.1/2	4
B610N54	—	N54	0.0550	0.051	1/2	2.1/2	4
B610N53	—	N53	0.0595	0.059	1/2	2.1/2	4
B6101/16	1/16	—	0.0625	0.059	1/2	2.1/2	4
B610N52	—	N52	0.0635	0.059	1/2	2.1/2	4
B610N51	—	N51	0.0670	0.066	3/4	3"	4
B610N50	—	N50	0.0700	0.066	3/4	3"	4
B610N49	—	N49	0.0730	0.066	3/4	3"	4
B610N48	—	N48	0.0760	0.072	3/4	3"	4
B6105/64	5/64	—	0.0781	0.072	3/4	3"	4
B610N47	—	N47	0.0785	0.072	3/4	3"	4
B610N46	—	N46	0.0810	0.077	3/4	3"	4
B610N45	—	N45	0.0820	0.077	3/4	3"	4
B610N44	—	N44	0.0860	0.081	3/4	3"	4
B610N43	—	N43	0.0890	0.081	3/4	3"	4
B610N42	—	N42	0.0935	0.088	3/4	3"	4
B6103/32	3/32	—	0.0938	0.088	3/4	3"	4
B610N41	—	N41	0.0960	0.093	7/8	3.1/2	4
B610N40	—	N40	0.0980	0.093	7/8	3.1/2	4
B610N39	—	N39	0.0995	0.093	7/8	3.1/2	4
B610N38	—	N38	0.1015	0.095	7/8	3.1/2	4
B610N37	—	N37	0.1040	0.095	7/8	3.1/2	4

Product	DC (inch)	DC (Wire gauge size)	DC (inch)	DCON MS (inch)	LCF (inch)	OAL (inch)	NOF
B610N36	—	N36	0.1065	0.103	7/8	3.1/2	4
B6107/64	7/64	—	0.1094	0.103	7/8	3.1/2	4
B610N35	—	N35	0.1100	0.103	7/8	3.1/2	4
B610N34	—	N34	0.1110	0.105	7/8	3.1/2	4
B610N33	—	N33	0.1130	0.105	7/8	3.1/2	4
B610N32	—	N32	0.1160	0.112	7/8	3.1/2	4
B610N31	—	N31	0.1200	0.112	7/8	3.1/2	4
B610.1230	—	—	0.1230	0.112	7/8	3.1/2	4
B610.1240	—	—	0.1240	0.119	7/8	3.1/2	4
B610.1247	—	—	0.1247	0.119	7/8	3.1/2	4
B6101/8	1/8	—	0.1250	0.119	7/8	3.1/2	4
B610.1260	—	—	0.1260	0.119	7/8	3.1/2	4
B610N30	—	N30	0.1285	0.119	7/8	3.1/2	4
B610N29	—	N29	0.1360	0.128	1"	4"	4
B610N28	—	N28	0.1400	0.135	1"	4"	4
B6109/64	9/64	—	0.1410	0.135	1"	4"	4
B610N27	—	N27	0.1440	0.135	1"	4"	4
B610N26	—	N26	0.1470	0.143	1"	4"	4
B610N25	—	N25	0.1495	0.143	1"	4"	4
B610N24	—	N24	0.1520	0.146	1"	4"	4
B610N23	—	N23	0.1540	0.146	1"	4"	4
B6105/32	5/32	—	0.1562	0.151	1"	4"	6
B610N22	—	N22	0.1570	0.151	1"	4"	6
B610N21	—	N21	0.1590	0.153	1.1/8	4.1/2	6
B610N20	—	N20	0.1610	0.153	1.1/8	4.1/2	6
B610N19	—	N19	0.1660	0.160	1.1/8	4.1/2	6
B610N18	—	N18	0.1695	0.160	1.1/8	4.1/2	6
B61011/64	11/64	—	0.1719	0.165	1.1/8	4.1/2	6

Product	DC	DC	DC	DCON	LCF	OAL	NOF
	(inch)	(Wire gauge size)	(inch)	MS (inch)			
B610N17	—	N17	0.1730	0.165	1.1/8	4.1/2	6
B610N16	—	N16	0.1770	0.170	1.1/8	4.1/2	6
B610N15	—	N15	0.1800	0.175	1.1/8	4.1/2	6
B610N14	—	N14	0.1820	0.175	1.1/8	4.1/2	6
B610N13	—	N13	0.1850	0.180	1.1/8	4.1/2	6
B610.1855	—	—	0.1855	0.180	1.1/8	4.1/2	6
B610.1865	—	—	0.1865	0.180	1.1/8	4.1/2	6
B610.1870	—	—	0.1870	0.180	1.1/8	4.1/2	6
B6103/16	3/16	—	0.1875	0.180	1.1/8	4.1/2	6
B610.1885	—	—	0.1885	0.180	1.1/8	4.1/2	6
B610N12	—	N12	0.1890	0.180	1.1/8	4.1/2	6
B610N11	—	N11	0.1910	0.186	1.1/4	5"	6
B610N10	—	N10	0.1935	0.186	1.1/4	5"	6
B610N9	—	N9	0.1960	0.190	1.1/4	5"	6
B610N8	—	N8	0.1990	0.190	1.1/4	5"	6
B610N7	—	N7	0.2010	0.195	1.1/4	5"	6
B61013/64	13/64	—	0.2031	0.195	1.1/4	5"	6
B610N6	—	N6	0.2040	0.195	1.1/4	5"	6
B610N5	—	N5	0.2055	0.202	1.1/4	5"	6
B610N4	—	N4	0.2090	0.202	1.1/4	5"	6
B610N3	—	N3	0.2130	0.207	1.1/4	5"	6
B6107/32	7/32	—	0.2188	0.207	1.1/4	5"	6
B610N2	—	N2	0.2210	0.217	1.1/2	6"	6
B610N1	—	N1	0.2280	0.217	1.1/2	6"	6
B610A	—	—	0.2340	0.227	1.1/2	6"	6
B61015/64	15/64	—	0.2344	0.227	1.1/2	6"	6
B610B	—	—	0.2380	0.233	1.1/2	6"	6
B610C	—	—	0.2420	0.233	1.1/2	6"	6
B610D	—	—	0.2460	0.233	1.1/2	6"	6
B610.2480	—	—	0.2480	0.233	1.1/2	6"	6
B610.2490	—	—	0.2490	0.240	1.1/2	6"	6
B610.2495	—	—	0.2495	0.240	1.1/2	6"	6
B6101/4	1/4	—	0.2500	0.240	1.1/2	6"	6
B610.2510	—	—	0.2510	0.240	1.1/2	6"	6
B610F	—	—	0.2570	0.248	1.1/2	6"	6
B610G	—	—	0.2610	0.248	1.1/2	6"	6
B61017/64	17/64	—	0.2656	0.248	1.1/2	6"	6
B610H	—	—	0.2660	0.248	1.1/2	6"	6
B610LETTERI	—	—	0.2720	0.248	1.1/2	6"	6
B610J	—	—	0.2770	0.248	1.1/2	6"	6
B610K	—	—	0.2810	0.248	1.1/2	6"	6
B6109/32	9/32	—	0.2812	0.248	1.1/2	6"	6
B610L	—	—	0.2900	0.279	1.1/2	6"	6
B610M	—	—	0.2950	0.279	1.1/2	6"	6
B61019/64	19/64	—	0.2969	0.279	1.1/2	6"	6
B610N	—	—	0.3020	0.279	1.1/2	6"	6
B610.3105	—	—	0.3105	0.279	1.1/2	6"	6
B610.3115	—	—	0.3115	0.279	1.1/2	6"	6
B610.3120	—	—	0.3120	0.279	1.1/2	6"	6
B6105/16	5/16	—	0.3125	0.279	1.1/2	6"	6
B610.3135	—	—	0.3135	0.279	1.1/2	6"	6
B610O	—	—	0.3160	0.279	1.1/2	6"	6
B610P	—	—	0.3230	0.279	1.1/2	6"	6
B61021/64	21/64	—	0.3281	0.279	1.1/2	6"	6
B610Q	—	—	0.3320	0.279	1.1/2	6"	6
B610R	—	—	0.3390	0.279	1.1/2	6"	6
B61011/32	11/32	—	0.3438	0.279	1.1/2	6"	6
B610S	—	—	0.3480	0.310	1.3/4	7"	6
B610T	—	—	0.3580	0.310	1.3/4	7"	6
B61023/64	23/64	—	0.3594	0.310	1.3/4	7"	6
B610U	—	—	0.3680	0.310	1.3/4	7"	6
B610.3730	—	—	0.3730	0.310	1.3/4	7"	6

Product	DC	DC	DC	DCON	LCF	OAL	NOF
	(inch)	(Wire gauge size)	(inch)	MS (inch)			
B610.3740	—	—	0.3740	0.310	1.3/4	7"	6
B610.3745	—	—	0.3745	0.310	1.3/4	7"	6
B6103/8	3/8	—	0.3750	0.310	1.3/4	7"	6
B610.3760	—	—	0.3760	0.310	1.3/4	7"	6
B610V	—	—	0.3770	0.310	1.3/4	7"	6
B610W	—	—	0.3860	0.310	1.3/4	7"	6
B61025/64	25/64	—	0.3910	0.310	1.3/4	7"	6
B610X	—	—	0.3970	0.310	1.3/4	7"	6
B610Y	—	—	0.4040	0.310	1.3/4	7"	6
B61013/32	13/32	—	0.4062	0.310	1.3/4	7"	6
B610Z	—	—	0.4130	0.373	1.3/4	7"	6
B61027/64	27/64	—	0.4219	0.373	1.3/4	7"	6
B610.4355	—	—	0.4355	0.373	1.3/4	7"	6
B610.4365	—	—	0.4365	0.373	1.3/4	7"	6
B610.4370	—	—	0.4370	0.373	1.3/4	7"	6
B6107/16	7/16	—	0.4375	0.373	1.3/4	7"	6
B610.4385	—	—	0.4385	0.373	1.3/4	7"	6
B61029/64	29/64	—	0.4531	0.373	1.3/4	7"	6
B61015/32	15/32	—	0.4688	0.373	1.3/4	7"	6
B61031/64	31/64	—	0.4844	0.435	2"	8"	6
B610.4980	—	—	0.4980	0.435	2"	8"	6
B610.4990	—	—	0.4990	0.435	2"	8"	6
B610.4995	—	—	0.4995	0.435	2"	8"	6
B6101/2	1/2	—	0.5000	0.435	2"	8"	6
B610.5010	—	—	0.5010	0.435	2"	8"	6
B61033/64	33/64	—	0.5156	0.435	2"	8"	6
B61017/32	17/32	—	0.5312	0.435	2"	8"	6
B61035/64	35/64	—	0.5469	0.435	2"	8"	8
B6109/16	9/16	—	0.5625	0.435	2"	8"	8
B61037/64	37/64	—	0.5781	0.435	2"	8"	8
B61019/32	19/32	—	0.5938	0.435	2"	8"	8
B61039/64	39/64	—	0.6094	0.562	2.1/4	9"	8
B6105/8	5/8	—	0.6250	0.562	2.1/4	9"	8
B61041/64	41/64	—	0.6410	0.562	2.1/4	9"	8
B61021/32	21/32	—	0.6562	0.562	2.1/4	9"	8
B61043/64	43/64	—	0.6719	0.562	2.1/4	9"	8
B61011/16	11/16	—	0.6875	0.562	2.1/4	9"	8
B61045/64	45/64	—	0.7031	0.562	2.1/4	9"	8
B61023/32	23/32	—	0.7188	0.562	2.1/4	9"	8
B61047/64	47/64	—	0.7344	0.625	2.1/2	9.1/2	8
B6103/4	3/4	—	0.7500	0.625	2.1/2	9.1/2	8
B61049/64	49/64	—	0.7656	0.625	2.1/2	9.1/2	8
B61025/32	25/32	—	0.7812	0.625	2.1/2	9.1/2	8
B61051/64	51/64	—	0.7969	0.625	2.1/2	9.1/2	8
B61013/16	13/16	—	0.8125	0.625	2.1/2	9.1/2	8
B61053/64	53/64	—	0.8281	0.625	2.1/2	9.1/2	8
B61027/32	27/32	—	0.8438	0.625	2.1/2	9.1/2	8
B61055/64	55/64	—	0.8594	0.750	2.5/8	10"	8
B6107/8	7/8	—	0.8750	0.750	2.5/8	10"	8
B61057/64	57/64	—	0.8910	0.750	2.5/8	10"	8
B61029/32	29/32	—	0.9062	0.750	2.5/8	10"	8
B61059/64	59/64	—	0.9219	0.750	2.5/8	10"	8
B61015/16	15/16	—	0.9375	0.750	2.5/8	10"	8
B61061/64	61/64	—	0.9531	0.750	2.5/8	10"	8
B61031/32	31/32	—	0.9688	0.750	2.5/8	10"	8
B61063/64	63/64	—	0.9844	0.875	2.3/4	10.1/2	8
B6101	1"	—	1.0000	0.875	2.3/4	10.1/2	8
B6101.1/16	1.1/16	—	1.0625	0.875	2.3/4	10.1/2	8
B6101.1/8	1.1/8	—	1.1250	0.875	2.7/8	11"	8
B6101.3/16	1.3/16	—	1.1875	1.000	2.7/8	11"	8
B6101.1/4	1.1/4	—	1.2500	1.000	3"	11.1/2	8
B6101.3/8	1.3/8	—	1.3750	1.000	3.1/4	12"	8
B6101.1/2	1.1/2	—	1.5000	1.250	3.1/2	12.1/2	8

B620



Escariador de máquina HSS de mango cilíndrico y hélice lenta, acabado brillante

Los versátiles escariadores de máquina de uso general tienen canales rectos más cortos y profundos que los escariadores manuales y están diseñados para un escariado en máquina eficaz en la mayoría de los materiales. Disponibles en una amplia gama de tamaños, incluyendo fraccionales, calibre de alambre, letras y tamaños decimales incrementales. Fabricados según ANSI B94.2-1983 (R1988).

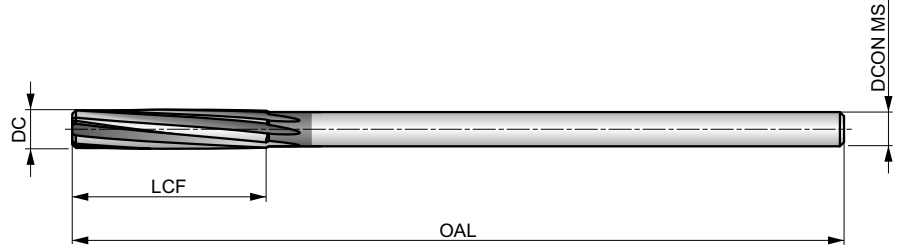

HSS	Bright	ANSI
R		

Grupo de Material de la pieza adecuado y condiciones de velocidad de corte iniciales (m/min) y código de avance alfabético. Tablas con avance por revolución a partir de la pag.279.

P1.1 ■ 21 C	P1.2 ■ 24 C	P1.3 ■ 25 C	P2.1 ■ 18 C	P2.2 ■ 16 C	P2.3 ■ 14 B	P3.1 ■ 13 B	P3.2 ■ 11 B	P3.3 ■ 9 B	P4.1 ■ 8 B	P4.2 ■ 7 B	P4.3 ■ 5 A	M1.1 ■ 11 C	M1.2 ■ 10 B
M2.1 ■ 9 B	M2.2 ■ 8 B	K1.1 ■ 16 E	K1.2 ■ 12 D	K1.3 ■ 9 D	K2.1 ■ 16 C	K2.2 ■ 13 C	K2.3 ■ 10 C	K3.1 ■ 14 C	K3.2 ■ 11 C	N1.1 ■ 24 F	N1.2 ■ 18 F	N1.3 ■ 11 F	N2.1 ■ 27 E
N2.2 ■ 24 E	N2.3 ■ 16 E	N3.1 ■ 47 D	N3.2 ■ 28 E	N3.3 ■ 14 D									

Product	DC	DC	DC	DCON MS	LCF	OAL	NOF
	(inch)	(Wire gauge size)	(inch)	(inch)	(inch)	(inch)	
B6201/16	1/16	—	0.0625	0.059	1/2	2.1/2	4
B6205/64	5/64	—	0.0781	0.072	3/4	3"	4
B6203/32	3/32	—	0.0938	0.088	3/4	3"	4
B6207/64	7/64	—	0.1094	0.103	7/8	3.1/2	4
B6201/8	1/8	—	0.1250	0.119	7/8	3.1/2	4
B6205/32	5/32	—	0.1562	0.151	1"	4"	6
B62011/64	11/64	—	0.1719	0.165	1.1/8	4.1/2	6
B6203/16	3/16	—	0.1875	0.180	1.1/8	4.1/2	6
B62013/64	13/64	—	0.2031	0.195	1.1/4	5"	6
B6207/32	7/32	—	0.2188	0.207	1.1/4	5"	6
B6201/4	1/4	—	0.2500	0.240	1.1/2	6"	6
B62017/64	17/64	—	0.2656	0.248	1.1/2	6"	6
B6209/32	9/32	—	0.2812	0.248	1.1/2	6"	6
B6205/16	5/16	—	0.3125	0.279	1.1/2	6"	6

Product	DC	DC	DC	DCON MS	LCF	OAL	NOF
	(inch)	(Wire gauge size)	(inch)	(inch)	(inch)	(inch)	
B62011/32	11/32	—	0.3438	0.279	1.1/2	6"	6
B6203/8	3/8	—	0.3750	0.310	1.3/4	7"	6
B62025/64	25/64	—	0.3910	0.310	1.3/4	7"	6
B62013/32	13/32	—	0.4062	0.310	1.3/4	7"	6
B6207/16	7/16	—	0.4375	0.373	1.3/4	7"	6
B62031/64	31/64	—	0.4844	0.435	2"	8"	6
B6201/2	1/2	—	0.5000	0.435	2"	8"	6
B62017/32	17/32	—	0.5312	0.435	2"	8"	6
B6209/16	9/16	—	0.5625	0.435	2"	8"	8
B6205/8	5/8	—	0.6250	0.562	2.1/4	9"	8
B62011/16	11/16	—	0.6875	0.562	2.1/4	9"	8
B6203/4	3/4	—	0.7500	0.625	2.1/2	9.1/2	8
B6207/8	7/8	—	0.8750	0.750	2.5/8	10"	8
B6201	1"	—	1.0000	0.875	2.3/4	10.1/2	8

B650



Escariador manual HSS de filos rectos, acabado brillante

Escariador manual de alta resistencia con filos rectos utilizado para el acabado manual de agujeros taladrados. El cuadrado de arrastre permite girar la herramienta con una llave o montarla fija para piezas rotativas. Adecuada para escariar la mayoría de los materiales, incluidos los aceros. Fabricado según ANSI B94.2-1983 (R1988).

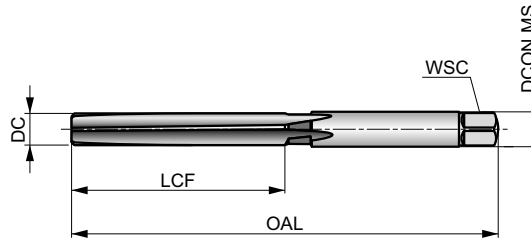

HSS	Bright	ANSI
R		

Grupo de Material de la pieza.

P1.1	P1.2	P1.3	P2.1	P2.2	P2.3	P3.1	P3.2	P3.3	P4.1	P4.2	P4.3	M1.1	M1.2
■	■	■	■	■	■	■	■	■	■	■	■	■	■
M2.1	K1.1	K1.2	K1.3	K2.1	K2.2	K2.3	K3.1	K3.2	N1.1	N1.2	N1.3	N2.1	N2.2
■	■	■	■	■	■	■	■	■	■	■	■	■	■
N2.3	N3.1	N3.2	N3.3	N4.1	N4.2								
■	■	■	■	■	■								

Product	DC	DC	LCF	OAL	NOF
	(inch)	(inch)	(inch)	(inch)	
B6501/8	1/8	0.1250	1.1/2	3"	6
B6503/16	3/16	0.1875	1.3/4	3.1/2	6
B6501/4	1/4	0.2500	2"	4"	6
B6505/16	5/16	0.3125	2.1/4	4.1/2	6
B6503/8	3/8	0.3750	2.1/2	5"	6
B6507/16	7/16	0.4375	2.3/4	5.1/2	6
B6501/2	1/2	0.5000	3"	6"	6
B6509/16	9/16	0.5625	3.1/4	6.1/2	8
B6505/8	5/8	0.6250	3.1/2	7"	8
B6503/4	3/4	0.7500	4.3/16	8.3/8	8
B6507/8	7/8	0.8750	4.7/8	9.3/4	8
B6501	1"	1.0000	5.7/16	10.7/8	8

B301



Escariador de Mano HSS para Pasadores Cónicos, Conicidad 1:48, Templado al Vapor y Acabado Brillante
 Diseñado para acabado de agujeros cónicos para pasadores cónicos imperiales de proporción estándar 1 a 48. Con un diámetro pequeño reducido, la herramienta se ubica y centra fácilmente en el agujero pretaladrado para mejorar la precisión y el rendimiento. Adecuado para escariado en muchos materiales.

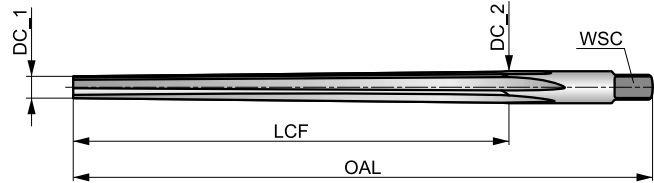

HSS	Bright ST	BS 328
R		A
1:48		

Grupo de Material de la pieza.

P1.1	P1.2	P1.3	P2.1	P2.2	P2.3	P3.1	P3.2	P3.3	P4.1	P4.2	P4.3	M1.1	M1.2
■	■	■	■	■	■	■	■	■	■	■	■	■	■
M2.1	K1.1	K1.2	K1.3	K2.1	K2.2	K2.3	K3.1	K3.2	N1.1	N1.2	N1.3	N2.1	N2.2
■	■	■	■	■	■	■	■	■	■	■	■	■	■
N2.3	N3.1	N3.2	N3.3	N4.1	N4.2								
■	■	■	■	■	■								

DC <= 1/4 límite de tolerancia +0.0030; DC >= 9/32 límite de tolerancia +0.0050.

Product	nom d	DC_1	DC_2	OAL	LCF	NOF	WSC	DCON MS
		(mm)	(mm)	(mm)	(mm)		(mm)	(mm)
B3013/32	3/32	1.75	2.41	57.0	32.0	4	2.00	2.41
B3011/8	1/8	2.30	3.23	70.0	44.0	4	2.50	3.23
B3015/32	5/32	2.95	4.01	76.0	51.0	4	3.10	4.01
B3013/16	3/16	3.50	4.95	102.0	70.0	4	4.00	4.95
B3011/4	1/4	4.64	6.43	117.0	86.0	6	5.00	6.43
B3015/16	5/16	5.84	8.03	143.0	105.0	6	6.30	8.03
B3013/8	3/8	7.03	9.68	165.0	127.0	6	8.00	9.68
B3011/2	1/2	9.41	12.85	210.0	165.0	6	10.00	12.85

B953



Escariador de Máquina HSS-E para Pasadores Cónicos, Conicidad 1:50, Mango Cilíndrico

Con gran ángulo de hélice y corte a derecha y a izquierda. El cono del escariador está diseñado para terminar los agujeros cónicos para alojar pasadores cónicos métricos de proporción estándar de 1 a 50, mientras que la punta cónica tiene un diámetro reducido para mejorar el rendimiento. Adecuado para escariar en muchos materiales.

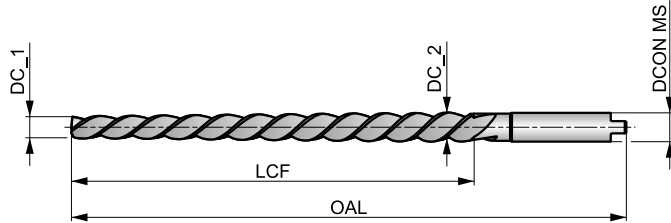

HSS-E	Bright	DIN 2179
R		1:50

Grupo de Material de la pieza adecuado y condiciones de velocidad de corte iniciales (m/min) y código de avance alfabético. Tablas con avance por revolución a partir de la pag.279.

P1.1 ■ 10 B	P1.2 ■ 12 B	P1.3 ■ 13 B	P2.1 ■ 9 B	P2.2 ■ 8 B	P2.3 ▣ 6 A	P3.1 ■ 7 A	P3.2 ▣ 6 A	P3.3 ▣ 3 A	P4.1 ■ 4 A	P4.2 ▣ 3 A	P4.3 ▣ 2 A	M1.1 ▣ 11 C	M1.2 ▣ 10 B
M2.1 ▣ 9 B	M2.2 ▣ 8 B	K1.1 ■ 10 C	K1.2 ■ 6 B	K1.3 ▣ 4 B	K2.1 ■ 8 A	K2.2 ■ 6 A	K2.3 ▣ 4 A	K3.1 ■ 7 A	K3.2 ▣ 4 A	N1.1 ▣ 14 D	N1.2 ■ 12 D	N1.3 ■ 9 D	N2.1 ■ 16 C
N2.2 ■ 14 C	N2.3 ▣ 10 C	N3.1 ■ 22 B	N3.2 ■ 14 C	N3.3 ▣ 6 B	N4.1 ▣ 22 B								

DCON MS tolerancia h9.

Product	nom d	DC_1	DC_2	OAL	LCF	NOF	DCON MS
		(mm)	(mm)	(mm)	(mm)		(mm)
B9532.0	2.0	1.90	2.86	86.0	48.0	3	3.15
B9532.5	2.5	2.40	3.36	86.0	48.0	3	3.15
B9533.0	3.0	2.90	4.06	100.0	58.0	3	4.00
B9534.0	4.0	3.90	5.26	112.0	68.0	3	5.00
B9535.0	5.0	4.90	6.36	122.0	73.0	3	6.30
B9536.0	6.0	5.90	8.00	160.0	105.0	3	8.00
B9536.5	6.5	6.40	8.78	188.0	119.0	3	8.50
B9538.0	8.0	7.90	10.80	207.0	145.0	3	10.00
B95310.0	10.0	9.90	13.40	245.0	175.0	3	12.50
B95312.0	12.0	11.80	16.00	290.0	210.0	3	16.00

B903



Escariador de Mano HSS para Pasadores Cónicos, Conicidad 1:50, Templado al Vapor y Acabado Brillante
 Diseñado para acabado de agujeros cónicos para pasadores cónicos métricos de proporción estándar 1 a 50. El diámetro del extremo es reducido para que sea más fácil ubicar y centrar el escariador en el agujero. Adecuado para escariado en muchos materiales.

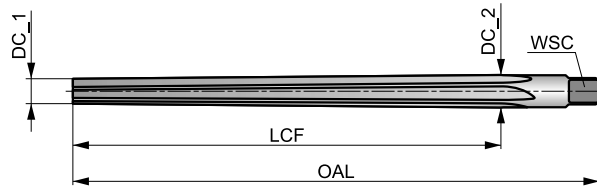

HSS	Bright ST	DIN 9
R		A
1:50		

Grupo de Material de la pieza.

P1.1	P1.2	P1.3	P2.1	P2.2	P2.3	P3.1	P3.2	P3.3	P4.1	P4.2	P4.3	M1.1	M1.2
■	■	■	■	■	■	■	■	■	■	■	■	■	■
M2.1	K1.1	K1.2	K1.3	K2.1	K2.2	K2.3	K3.1	K3.2	N1.1	N1.2	N1.3	N2.1	N2.2
■	■	■	■	■	■	■	■	■	■	■	■	■	■
N2.3	N3.1	N3.2	N3.3	N4.1	N4.2								
■	■	■	■	■	■								

DCON MS tolerancia h11; DC ≤ 5mm límite de tolerancia +0.0750; DC < 5mm límite de tolerancia +0.1250.

Product	nom d	DC_1	DC_2	OAL	LCF	NOF	WSC	DCON MS
		(mm)	(mm)	(mm)	(mm)		(mm)	
B9031.5	1.5	1.40	2.14	57.0	37.0	4	1.80	2.14
B9032.0	2.0	1.90	2.86	68.0	48.0	4	2.24	2.86
B9032.5	2.5	2.40	3.36	68.0	48.0	4	2.80	3.36
B9033.0	3.0	2.90	4.06	80.0	58.0	4	3.15	4.00
B9034.0	4.0	3.90	5.26	93.0	68.0	4	4.00	5.00
B9035.0	5.0	4.90	6.36	100.0	73.0	4	5.00	6.30
B9036.0	6.0	5.90	8.00	135.0	105.0	6	6.30	7.90
B9038.0	8.0	7.90	10.80	180.0	145.0	6	8.00	10.50
B90310.0	10.0	9.90	13.40	215.0	175.0	6	10.00	13.30
B90312.0	12.0	11.80	16.00	255.0	210.0	8	11.20	16.00
B90313.0	13.0	12.86	16.74	255.0	210.0	8	12.50	16.74
B90314.0	14.0	13.86	17.74	255.0	210.0	8	12.50	17.74
B90316.0	16.0	15.80	20.40	280.0	230.0	8	14.00	20.40
B90320.0	20.0	19.80	24.80	310.0	250.0	8	18.00	24.80

B952



Escariador de Máquina HSS-E para Pasadores Cónicos, Conicidad 1:50, Mango Cilíndrico

Con corte a derecha y a izquierda, proporciona un escariado suave para un tamaño de agujero más preciso y un mejor acabado. Se ha reducido el diámetro de la punta, lo que facilita la ubicación y el centrado del escariador en el agujero. Adecuado para escariar en muchos materiales.

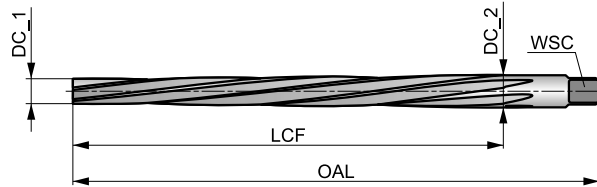

HSS	Bright	DIN 9
R		B
1:50		

Grupo de Material de la pieza.

P1.1	P1.2	P1.3	P2.1	P2.2	P2.3	P3.1	P3.2	P3.3	P4.1	P4.2	P4.3	M1.1	M1.2
■	■	■	■	■	■	■	■	■	■	■	■	■	■
M2.1	K1.1	K1.2	K1.3	K2.1	K2.2	K2.3	K3.1	K3.2	N1.1	N1.2	N1.3	N2.1	N2.2
■	■	■	■	■	■	■	■	■	■	■	■	■	■
N2.3	N3.1	N3.2	N3.3	N4.1	N4.2								
■	■	■	■	■	■								

DCON MS tolerancia h11; DC ≤ 2.5mm Estrías rectas, forma A.

Product	nom d	DC_1	DC_2	OAL	LCF	NOF	WSC	DCON MS
		(mm)	(mm)	(mm)	(mm)		(mm)	(mm)
B9521.2	1.2	1.10	1.74	50.0	32.0	3	2.40	3.15
B9521.5	1.5	1.40	2.14	57.0	37.0	3	2.40	3.15
B9522.0	2.0	1.90	2.86	68.0	48.0	3	2.40	3.15
B9522.5	2.5	2.40	3.36	68.0	48.0	4	2.40	3.15
B9523.0	3.0	2.90	4.06	80.0	58.0	5	3.00	4.00
B9523.5	3.5	3.40	4.66	87.0	63.0	5	3.40	4.50
B9524.0	4.0	3.90	5.26	93.0	68.0	5	3.80	5.00
B9525.0	5.0	4.90	6.36	100.0	73.0	5	4.90	6.30
B9526.0	6.0	5.90	8.00	135.0	105.0	6	6.20	8.00
B9527.0	7.0	6.90	9.40	160.0	125.0	6	7.00	9.00
B9528.0	8.0	7.90	10.80	180.0	145.0	6	8.00	10.00
B9529.0	9.0	8.90	12.10	195.0	160.0	6	9.00	11.20
B95210.0	10.0	9.90	13.40	215.0	175.0	6	10.00	12.50
B95212.0	12.0	11.80	16.00	255.0	210.0	8	11.00	14.00
B95213.0	13.0	12.80	17.00	255.0	210.0	8	12.00	16.00
B95214.0	14.0	13.80	18.00	255.0	210.0	8	12.00	16.00
B95216.0	16.0	15.80	20.40	280.0	230.0	8	14.50	18.00
B95220.0	20.0	19.80	24.80	310.0	250.0	8	18.00	22.40
B95225.0	25.0	24.70	30.70	370.0	300.0	10	22.00	28.00
B95230.0	30.0	29.70	36.10	400.0	320.0	10	24.00	31.50
B95240.0	40.0	39.70	46.50	430.0	340.0	12	32.00	40.00

B630



Escariador de máquina HSS de mango cilíndrico para pasadores cónicos, acabado brillante

La espiral lenta a derechas permite a estos escariadores un funcionamiento más suave y sin vibraciones que los escariadores de filo recto. Recomendado para materiales más difíciles de escariar, produce mejores acabados superficiales, es ideal para interrupciones y puede ayudar en la evacuación de virutas de agujeros ciegos. Fabricados según ANSI B94.2-1983 (R1988).

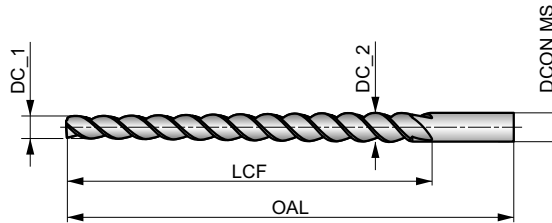

HSS	Bright	ANSI
R		1:48

Grupo de Material de la pieza adecuado y condiciones de velocidad de corte iniciales (m/min) y código de avance alfabético. Tablas con avance por revolución a partir de la pag.279.

P1.1 ■ 10 B	P1.2 ■ 12 B	P1.3 ■ 13 B	P2.1 ■ 9 B	P2.2 ■ 8 B	P2.3 ▣ 6 A	P3.1 ■ 7 A	P3.2 ▣ 6 A	P3.3 ▣ 3 A	P4.1 ■ 4 A	P4.2 ▣ 3 A	P4.3 ▣ 2 A	M1.1 ▣ 11 C	M1.2 ▣ 10 B
M2.1 ▣ 9 B	M2.2 ▣ 8 B	K1.1 ■ 10 C	K1.2 ■ 6 B	K1.3 ▣ 4 B	K2.1 ■ 8 A	K2.2 ■ 6 A	K2.3 ▣ 4 A	K3.1 ■ 7 A	K3.2 ▣ 4 A	N1.1 ▣ 14 D	N1.2 ■ 12 D	N1.3 ■ 9 D	N2.1 ■ 16 C
N2.2 ■ 14 C	N2.3 ▣ 10 C	N3.1 ■ 22 B	N3.2 ■ 14 C	N3.3 ▣ 6 B	N4.1 ▣ 22 B								

Product	nom d	DC_1	DC_2	DCON MS	LCF	OAL	NOF
		(inch)	(inch)	(inch)	(inch)	(inch)	
B6307/0	7/0	0.0497	0.0666	5/64	13/16	1.13/16	2
B6306/0	6/0	0.0611	0.0810	3/32	15/16	1.15/16	2
B6305/0	5/0	0.0719	0.0966	7/64	1.3/16	2.3/16	2
B6304/0	4/0	0.0869	0.1142	1/8	1.5/16	2.5/16	2
B6303/0	3/0	0.1029	0.1300	9/64	1.5/16	5.5/16	2
B6302/0	2/0	0.1137	0.1462	5/32	1.9/16	2.9/16	3
B630N1	1	0.1447	0.1798	3/16	1.11/16	2.15/16	3
B630N2	2	0.1600	0.2010	13/64	1.15/16	3.3/16	3

Product	nom d	DC_1	DC_2	DCON MS	LCF	OAL	NOF
		(inch)	(inch)	(inch)	(inch)	(inch)	
B630N3	3	0.1813	0.2294	15/64	2.5/16	3.11/16	3
B630N4	4	0.2071	0.2600	17/64	2.9/16	4.1/16	3
B630N5	5	0.2410	0.2994	5/16	2.13/16	4.5/16	3
B630N6	6	0.2773	0.3540	23/64	3.11/16	5.7/16	3
B630N7	7	0.3297	0.4220	13/32	4.7/16	6.5/16	3
B630N8	8	0.3971	0.5050	7/16	5.3/16	7.3/16	3
B630N9	9	0.4800	0.6066	9/16	6.1/16	8.5/16	4
B630N10	10	0.5799	0.7216	5/8	6.13/16	9.5/16	4

B660



Escariador manual HSS de fillos rectos para pasadores cónicos, acabado brillante

Diseñada para convertir un agujero taladrado recto en un agujero cónico (1/4" por pie) para pasadores cónicos estándar (ASA B5.20-1958). El cuadrado de arrastre permite girar la herramienta con una llave o montarla fija para piezas rotativas. Adecuada para escariar la mayoría de los materiales, incluidos los aceros. Fabricada según ANSI B94.2-1983 (R1988).

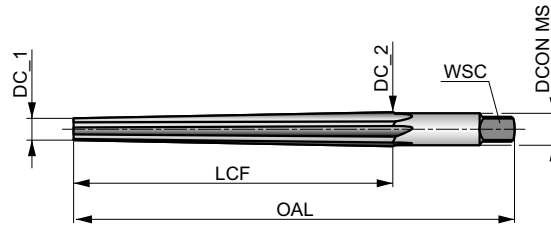

HSS	Bright	ANSI
R		1:48

Grupo de Material de la pieza.

P1.1	P1.2	P1.3	P2.1	P2.2	P2.3	P3.1	P3.2	P3.3	P4.1	P4.2	P4.3	M1.1	M1.2
■	■	■	■	■	■	■	■	■	■	■	■	■	■
M2.1	K1.1	K1.2	K1.3	K2.1	K2.2	K2.3	K3.1	K3.2	N1.1	N1.2	N1.3	N2.1	N2.2
■	■	■	■	■	■	■	■	■	■	■	■	■	■
N2.3	N3.1	N3.2	N3.3	N4.1	N4.2								
■	■	■	■	■	■								

Product	nom d	DC_1 (inch)	DC_2 (inch)	DCON MS (inch)	LCF (inch)	OAL (inch)	WSC (inch)	NOF
B660N0	0	0.1287	0.1638	11/64	1.11/16	2.15/16	0.130	6
B660N1	1	0.1447	0.1798	3/16	1.11/16	2.15/16	0.140	6
B660N2	2	0.1600	0.2010	13/64	1.15/16	3.3/16	0.150	6
B660N3	3	0.1813	0.2294	15/64	2.5/16	3.11/16	0.175	6
B660N4	4	0.2071	0.2600	17/64	2.9/16	4.1/16	0.200	6
B660N5	5	0.2410	0.2994	5/16	2.13/16	4.5/16	0.235	6
B660N6	6	0.2773	0.3540	23/64	3.11/16	5.7/16	0.270	6
B660N7	7	0.3297	0.4220	13/32	4.7/16	6.5/16	0.305	6
B660N8	8	0.3971	0.5050	7/16	5.3/16	7.3/16	0.330	6
B660N9	9	0.4800	0.6066	9/16	6.1/16	8.5/16	0.420	8
B660N10	10	0.5799	0.7216	5/8	6.13/16	9.5/16	0.470	8

B670



Escariador manual HSS de filos helicoidales para pasadores cónicos, acabado brillante

Corte a derechas con espiral lenta a izquierdas para escariar un agujero cónico (1/4" por pie) para pasadores cónicos estándar (ASA B5.20-1958). El cuadrado de arrastre permite girar la herramienta o montar la herramienta estática para piezas rotativas. El canal en espiral mejora el acabado superficial ayudando a la evacuación de la viruta. Fabricado según ANSI B94.2-1983 (R1988).

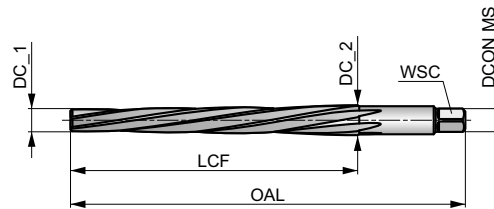

HSS	Bright	ANSI
R		1:48

Grupo de Material de la pieza.

P1.1	P1.2	P1.3	P2.1	P2.2	P2.3	P3.1	P3.2	P3.3	P4.1	P4.2	P4.3	M1.1	M1.2
■	■	■	■	■	■	■	■	■	■	■	■	■	■
M2.1	K1.1	K1.2	K1.3	K2.1	K2.2	K2.3	K3.1	K3.2	N1.1	N1.2	N1.3	N2.1	N2.2
■	■	■	■	■	■	■	■	■	■	■	■	■	■
N2.3	N3.1	N3.2	N3.3	N4.1	N4.2								
■	■	■	■	■	■								

Nom d es el número del pasador cónico según la Norma Americana de Especificación de Pasadores Cónicos (ASA B5.20-1958)

Product	nom d	DC_1 (inch)	DC_2 (inch)	DCON MS (inch)	LCF (inch)	OAL (inch)	WSC (inch)	NOF
B670N0	0	0.1287	0.1638	11/64	1.11/16	2.15/16	0.130	6
B670N1	1	0.1447	0.1798	3/16	1.11/16	2.15/16	0.140	6
B670N2	2	0.1600	0.2010	13/64	1.15/16	3.3/16	0.150	6
B670N3	3	0.1813	0.2294	15/64	2.5/16	3.11/16	0.175	6
B670N4	4	0.2071	0.2600	17/64	2.9/16	4.1/16	0.200	6
B670N5	5	0.2410	0.2994	5/16	2.13/16	4.5/16	0.235	6
B670N6	6	0.2773	0.3540	23/64	3.11/16	5.7/16	0.270	6
B670N7	7	0.3297	0.4220	13/32	4.7/16	6.5/16	0.305	6
B670N8	8	0.3971	0.5050	7/16	5.3/16	7.3/16	0.330	6
B670N9	9	0.4800	0.6066	9/16	6.1/16	8.5/16	0.420	8
B670N10	10	0.5799	0.7216	5/8	6.13/16	9.5/16	0.470	8

B680



Escariador manual HSS de filos helicoidales para tubo cónico NPT, acabado brillante

Corte a derechas con espiral a izquierdas para escariar un agujero cónico (3/4" por pie) antes del roscado NPT. El cuadrado de arrastre permite girar la herramienta o montarla estática para piezas rotativas. El filo en espiral mejora el acabado superficial al facilitar la evacuación de la viruta. Fabricado según ANSI B94.2-1983 (R1988).

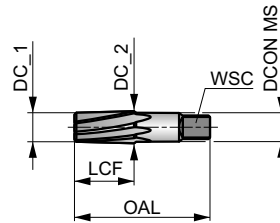

HSS	Bright	ANSI
R		

Grupo de Material de la pieza.

P1.1	P1.2	P1.3	P2.1	P2.2	P2.3	P3.1	P3.2	P3.3	P4.1	P4.2	P4.3	M1.1	M1.2
■	■	■	■	■	■	■	■	■	■	■	■	■	■
M2.1	K1.1	K1.2	K1.3	K2.1	K2.2	K2.3	K3.1	K3.2	N1.1	N1.2	N1.3	N2.1	N2.2
■	■	■	■	■	■	■	■	■	■	■	■	■	■
N2.3	N3.1	N3.2	N3.3	N4.1	N4.2								
■	■	■	■	■	■								

Nom d es el tamaño de rosca para tubería NPT.

Product	nom d	DC_1 (inch)	DC_2 (inch)	DCON MS (inch)	LCF (inch)	OAL (inch)	WSC (inch)	NOF
B6801/8	1/8	0.3160	0.3620	0.438	3/4	2.1/8	0.328	6
B6801/4	1/4	0.4060	0.4720	0.563	1.1/16	2.7/16	0.421	6
B6803/8	3/8	0.5400	0.6060	0.700	1.1/16	2.9/16	0.531	8
B6801/2	1/2	0.6650	0.7510	0.688	1.3/8	3.1/8	0.575	8
B6803/4	3/4	0.8760	0.9620	0.906	1.3/8	3.1/4	0.679	10
B6801	1"	1.1030	1.2120	1.125	1.3/4	3.3/4	0.843	10

B122



Escariador de Mano HSS, Mango Reducido, Hélice a Izquierda, Templado al Vapor y Acabado Bronce

Diseñado para realinear agujeros en chapas de acero delgadas, antes de atornillarlas o remacharlas. Diseñado para utilizar a mano. El pequeño diámetro del piloto simplifica la ubicación y alineación de la herramienta en agujeros pretaladrados. Adecuado para escariado en muchos materiales.

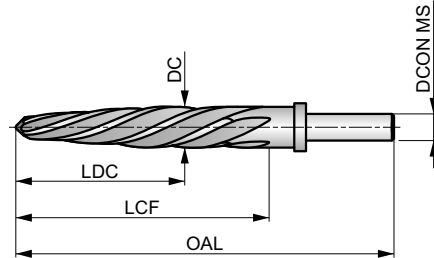

HSS	ST Bronze	ANSI
R		

Grupo de Material de la pieza adecuado y condiciones de velocidad de corte iniciales (m/min) y código de avance alfabético. Tablas con avance por revolución a partir de la pag.279.

P1.1 ■ 15 C	P1.2 ■ 16 C	P1.3 ■ 17 C	P2.1 ■ 13 C	P2.2 ■ 11 C	P3.1 ■ 7 B	M1.1 ■ 11 C	M1.2 ■ 10 B	M2.1 ■ 9 B	N1.1 ■ 23 F	N1.2 ■ 17 F	N2.1 ■ 23 E	N2.2 ■ 21 E	N3.1 ■ 34 D
N3.2 ■ 20 E	N4.1 ■ 22 B	N4.2 ■ 21 B											

Product	DC (inch)	DC (inch)	OAL (inch)	LCF (inch)	NOF	DCON MS (inch)
B1223/8	3/8	0.3750	4.5/8	2.1/2	4	3/8
B1221/2	1/2	0.5000	5.7/8	3.3/4	5	1/2
B1229/16	9/16	0.5625	5.7/8	3.3/4	5	1/2
B1225/8	5/8	0.6250	6.3/8	4.1/4	5	1/2
B12211/16	11/16	0.6875	6.3/8	4.1/4	5	1/2
B1223/4	3/4	0.7500	6.7/8	4.1/2	5	1/2
B12213/16	13/16	0.8125	6.7/8	4.1/2	5	1/2
B1227/8	7/8	0.8750	6.7/8	4.1/2	5	1/2
B12215/16	15/16	0.9375	6.7/8	4.1/2	5	1/2
B1221	1"	1.0000	6.7/8	4.1/2	5	1/2

Código de Material (BMC)	HSS	HSS	HSS	HSS	HSS	HSS	HSS
Grupo básico estándar (BSG)	DIN ANSI	DIN 338	DIN 338	DIN 338	DIN 338	DIN 338	DIN 338
Longitud Útil (ULDR)	2.5xD	4xD	4xD	4xD	4xD	4xD	4xD
Ángulo de aplicación							
Recubrimiento							
Mango							
Forma de la Hélice							
Mano (dirección de corte)							
Código de Familia de Producto	A088	A089	A087	A094	A095	A099 Drillboy	A188
Gama de diámetros de corte PSF	Set	Set	Set	Set	Set	Set	Set
	92	92	93	93	94	94	95
P	P1						
	P2						
	P3						
	P4						
M	M1						
	M2						
	M3						
	M4						
K	K1						
	K2						
	K3						
	K4						
	K5						
N	N1						
	N2						
	N3						
	N4						
	N5						
S	S1						
	S2						
	S3						
	S4						
H	H1						
	H2						
	H3						
	H4						

	A295	A190	A191	A191_2	NEW M900	NEW M901	NEW M902	A080
	Set	Set	Set	Set	Size 1 - 9	Set	Set	Set
	95	96	97	97	98	99	99	99
P1					■			
P2					■			
P3					■			
P4					■			
M1					■			
M2					■			
M3					▣			
M4								
K1					■			
K2					■			
K3					■			
K4					■			
K5					■			
N1					■			
N2					■			
N3					■			
N4					■			
N5					■			
S1								
S2								
S3								
S4								
H1								
H2								
H3								
H4								





A088

DORMER



Juego de Brocas A022 HSS, Serie Extra Corta, con la Punta Recubierta TiN

Un juego que contiene 24 diámetros diferentes de la broca A022 en un resistente estuche, con una amplia gama de tamaños cubiertos en una sola compra. Las brocas son adecuadas para su uso tanto en máquinas como en taladrados manuales en muchas aplicaciones. El recubrimiento TiN-Tip mejora el rendimiento y prolonga la vida útil de la herramienta.

HSS	DIN ANSI	2.5xD
	TiN-Tip	
		DC h8

A=Tipos en el Juego, B=No en el Juego, C=Diámetros en el Juego.

Product	Nr.	A	B	C
A0882005	2005	A022	24	1.0 mm - 10.5 mm x 0.5 mm + 3.3 mm, 4.2 mm, 6.8 mm, 10.2 mm





A089

DORMER



Juego de Brocas A002 HSS, Serie Corta, con la Punta Recubierta TiN

Un juego que contiene 5 diámetros diferentes de la popular broca A002 en un práctico estuche, cubriendo varios diámetros con una sola compra. Las brocas son adecuadas para su uso tanto en máquinas como en taladrados manuales en muchas aplicaciones. El recubrimiento TiN-Tip mejora el rendimiento y prolonga la vida útil de la herramienta.

HSS	DIN 338	4xD
	TiN-Tip	
		DC h8

A=Tipos en el Juego, B=No en el Juego, C=Diámetros en el Juego.

Product	Nr.	A	B	C
A08910	10	A002	5	A0024.0, A0025.0, A0026.0, A0028.0, A00210.0

A087



Juego de Brocas A002 HSS Serie Corta, con la Punta Recubierta TiN

Un juego que contiene 19 diámetros diferentes de la popular broca A002 en un estuche compacto fácil de transportar, con tamaños que se muestran claramente para una fácil selección. Las brocas son adecuadas para su uso tanto en máquinas como en taladrados manuales, y en muchas aplicaciones. El recubrimiento TiN-Tip mejora el rendimiento y prolonga la vida útil de la herramienta.

HSS	DIN 338	4xD
118°	TiN-Tip	
λ.20-35°	R	DC h8

A=Tipos del Juego, B=No del Juego, C=Diámetros en el Juego 1.0mm =< DC >= 2.9mm Punta de 4 caras a 118°

Product	Nr.	A	B	C
A087201	201	A002	19	1.0 mm - 10.0 mm x 0.5 mm

A094



Juego de Brocas A002 HSS, Serie Corta, con la Punta Recubierta TiN

Un juego que contiene brocas A002 de diferentes diámetros métricos en un dispensador giratorio inteligentemente diseñado que hace que la selección del tamaño requerido sea muy simple. Gire la tapa de plástico transparente hasta que el agujero de la carcasa resalte el tamaño requerido y dé la vuelta al juego para sacar la broca.

HSS	DIN 338	4xD
118°	TiN-Tip	
λ.20-35°	R	DC h8

A=Tipos del Juego, B=No del Juego, C=Diámetros en el Juego 1.0mm =< DC >= 2.9mm Punta de 4 caras a 118°

Product	Nr.	A	B	C
A094413	413	A002	13	1.5 mm - 6.5 mm x 0.5 mm + 3.3 mm, 4.2 mm
A094419	419	A002	19	1.0 mm - 10.0 mm x 0.5 mm

A095



Juego de Brocas HSS Serie Corta, con Brocas A002, Recubrimiento TiN en la Punta

Diferentes juegos de nuestras brocas A002 en tamaños métricos o fraccionales, en un útil estuche de plástico. El juego mantiene todas las brocas juntas, con tamaños que se muestran claramente para una fácil selección. Las brocas son adecuadas para su uso tanto en máquinas como en aplicaciones manuales. El recubrimiento TiN-Tip mejora el rendimiento y prolonga la vida útil de la herramienta.

HSS	DIN 338	4xD
118°		
λ 20-35°		DC h8

1.0mm =< DC >= 2.9mm Punta de 4 caras a 118°. A=Tipos en el Juego, B=No en el Juego, C=Diámetros en el Juego.

Product	Nr.	A	B	C
A09518	18	A002	29	1/16 inch - 1/2 inch x 1/64 inch
A095200	200	A002	24	1.0 mm - 10.5 mm x 0.5 mm + 3.3 mm, 4.2 mm, 6.8 mm, 10.2 mm
A095201	201	A002	19	1.0 mm - 10.0 mm x 0.5 mm
A095202	202	A002	51	1.0 mm - 6.0 mm x 0.1 mm
A095203	203	A002	41	6.0 mm - 10.0 mm x 0.1 mm
A095204	204	A002	25	1.0 mm - 13.0 mm x 0.5 mm
A095206	206	A002	29	1.0 mm - 13.0 mm x 0.5 mm + 3.3 mm, 4.2 mm, 6.8 mm, 10.2 mm
A095209	209	A002	91	1.0 mm - 10.0 mm x 0.1 mm

A099 Drillboy



Expositor de Mostrador con Brocas A002 HSS Serie Corta, con la Punta Recubierta TiN

Dispensador de mostrador que contiene una amplia gama de tamaños de brocas A002. Diseñado para colocarse sobre un mostrador u otra superficie plana adecuada para una exhibición prominente y donde las brocas se pueden extraer fácilmente cuando sea necesario. Fácil de rellenar con más brocas A002, ofrecerá años de servicio.

HSS	DIN 338	4xD
118°		
λ 20-35°		DC h8

1.0mm =< DC >= 2.9mm Punta de 4 caras a 118°. A=Tipos en el Juego, B=No en el Juego, C=Diámetros en el Juego.





Product	Nr.	A	B	C
A099DRILLBOYXL	DRILLBOY	A002	55	3 x (1.0, 1.5, 2.0, 2.5, 3.0, 3.3, 3.5, 4.0) + 2 x (4.2, 4.5, 5.0, 5.5, 6.0, 6.5, 6.8, 7.0, 7.5, 8.0) + 8.5, 9.0, 9.5, 10.0, 10.2, 10.5, 11.0, 11.5, 12.0, 12.5, 13.0 mm

A188



Juego de Brocas A108 HSS, Serie Corta, Acabado Templado al Vapor

Un juego con diferentes tamaños métricos de nuestras brocas A108 en un útil estuche de plástico. Se pueden utilizar en diferentes aplicaciones con máquinas y taladros manuales.

HSS	DIN 338	4xD
 135°	 ST	
 λ > 35°	 R	DC h8

A=Tipos del Juego, B=No del Juego, C=Diámetros en el Juego DC > 1.5mm; 1/16" Punta afilada en cruz





Product	Nr.	A	B	C
A188201	201	A108	19	1.0 mm - 10.0 mm x 0.5 mm
A188204	204	A108	25	1.0 mm - 13.0 mm x 0.5 mm

A295



Juego de Brocas A777 HSS-E (8% Cobalto), Serie Corta, con Acabado Bronce

Un juego con diferentes tamaños fraccionales de nuestras brocas A777 en un útil estuche de plástico. El juego mantiene todas las brocas juntas y ordenadas, con tamaños que se muestran claramente para una fácil selección. Las brocas A777 están diseñadas con punta dividida a 135° para facilitar el autocentrado y reducir las fuerzas de corte.

HSS-E	DIN 338	4xD
 135°	 Bronze	
 λ 20-35°	 R	DC h8

A=Tipos en el Juego, B=No en el Juego, C=Diámetros en el Juego. DC ≤ 1.4mm Punta de 4 caras

Product	Nr.	A	B	C
A295219	219	A777	19	1.0 mm - 10.0 mm x 0.5 mm
A295225	225	A777	25	1.0 mm - 13.0 mm x 0.5 mm





A190

DORMER



Juego de Brocas HSS Serie Corta, con Brocas A100, Acabado Templado al Vapor

Juego de brocas A100 con punta convencional a 118°. Se suministra en juegos de tamaño métrico o fraccional en una práctica caja de plástico que hace que la selección del tamaño de broca requerido sea muy simple.

HSS	DIN 338	4xD
 118°	 ST	
 λ 20-35°		DC h8

A=Tipos del Juego, B=No del Juego, C=Diámetros en el Juego DC ≤ 1mm; 3/64"; N60 Brillante

Product	Nr.	A	B	C
A1903	3	A100	21	1/16 inch - 3/8 inch x 1/64 inch
A19012	12	A100	60	No.1 - No.60
A19018	18	A100	29	1/16 inch - 1/2 inch x 1/64 inch
A19020	20	A100	15	1/16 inch - 1/2 inch x 1/32 inch
A190201	201	A100	19	1.0 mm - 10.0 mm x 0.5 mm
A190202	202	A100	51	1.0 mm - 6.0 mm x 0.1 mm
A190203	203	A100	41	6.0 mm - 10.0 mm x 0.1 mm
A190204	204	A100	25	1.0 mm - 13.0 mm x 0.5 mm
A190206	206	A100	29	1.0 mm - 13.0 mm x 0.5 mm + 3.3 mm, 4.2 mm, 6.8 mm, 10.2 mm
A190209¹⁾	209	A100	91	1.0 mm - 10.0 mm x 0.1 mm





¹⁾ Se vende en cajas de 2. Caja 1 contiene las medidas (1.0-5.9 x 0.1mm); Caja 2 contiene las medidas (6.0-10.0 x 0.1mm).

A191



Juego de Brocas A100 HSS, Serie Corta, Acabado Templado al Vapor

Un juego que contiene brocas A100 de diferentes diámetros métricos en un estuche compacto fácil de transportar, con tamaños que se muestran claramente para una fácil selección. Brocas A100 con punta convencional a 118°. Se suministra en juegos de tamaños métricos o de cable, en una práctica caja de plástico que facilita la selección del tamaño de broca requerido.

HSS	DIN 338	4xD
 118°	Bright	
 λ 20-35°		DC h8

A=Tipos del Juego, B=No del Juego, C=Diámetros en el Juego DC <= 1mm; 3/64"; N60 Brillante





Product	Nr.	A	B	C
A19131M	31M	A100	20	0.3 mm - 1.0 mm x 0.05 mm + 0.38 mm, 0.52 mm, 0.58 mm, 0.78 mm, 0.82 mm

A191_2



Juego de Brocas A100 HSS, Serie Corta, Acabado Templado al Vapor

Un juego que contiene brocas A100 de diferentes diámetros métricos en un dispensador giratorio inteligentemente diseñado que hace que la selección del tamaño requerido sea muy simple. Gire la tapa de plástico transparente hasta que el agujero de la carcasa resalte el tamaño requerido y dé la vuelta al juego para sacar la broca.

HSS	DIN 338	4xD
 118°	ST	
 λ 20-35°		DC h8

A=Tipos del Juego, B=No del Juego, C=Diámetros en el Juego DC <= 1mm; 3/64"; N60 Brillante

Product	Nr.	A	B	C
A191413	413	A100	13	1.5 mm - 6.5 mm x 0.5 mm + 3.3 mm, 4.2 mm
A191419	419	A100	19	1.0 mm - 10.0 mm x 0.5 mm

M900







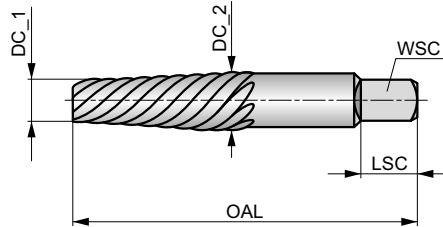

Extractor de tornillos

El extractor de tornillos se utiliza en sentido antihorario para extraer de agujeros roscados tornillos rotos de giro a derecha sin dañar las roscas. Es necesario taladrar un agujero guía de tamaño apropiado antes de utilizar el extractor.



Broca tamaño A: para utilizar con tornillos de resistencia a la tracción baja y media. Broca tamaño B: para utilizar con tornillos de resistencia a la tracción alta.

Product							DC_1	DC_2	WSC	LSC	OAL
		(mm)	(mm)	(inch)	(inch)	(inch)					
M9001	M5 - M6	2	2	3/16" - 1/4"	5/64	5/64	1.37	3.20	2.60	5.1	51.1
M9002	M6 - M8	2.8	3	1/4" - 5/16"	7/64	1/8	2.18	4.80	3.90	6.7	61.1
M9003	M8 - M12	4	4.2	5/16" - 7/16"	5/32	11/64	3.18	6.40	4.80	7.5	68.7
M9004	M12 - M14	5.5	6	7/16" - 9/16"	7/32	15/64	4.37	8.00	6.00	8	76.7
M9005	M14 - M20	7.2	8	9/16" - 3/4"	9/32	5/16	6.35	11.10	8.30	11.5	86.1
M9006	M20 - M30	10.5	11	3/4" - 1"	13/32	7/16	9.53	15.90	11.90	13.1	94.4
M9007	M30 - M42	13.5	14.5	1" - 1.3/8"	17/32	9/16	12.30	19.10	14.30	17.9	107.4
M9008	M42 - M45	20.5	21.5	1.3/8" - 1.3/4"	13/16	27/32	18.65	25.10	19.80	19.4	114.3
M9009	M45 - M50	27	28	1.3/4" - 2.1/8"	1.1/16	1.3/32	24.61	32.30	24.60	22.6	121.3

M901

DORMER



Juego de extractores de tornillos

Juegos de extractores de tornillos tamaños M9001 - M9005 o M9001 - M9006.

A=Tipos en el Juego, B=No en el Juego, C=Diámetros en el Juego

Product	Nr.	A	B	C
M901A	A	M900	5	M9001-M9005
M901B	B	M900	6	M9001-M9006

M902



Kit de extracción de tornillos

Las herramientas para extraer tornillos rotos a derecha vienen en juegos de cuatro. En primer lugar, se utiliza la lima rotativa P100 para aplanar el perno. En segundo lugar, se utiliza la lima rotativa P101 para crear un cono de inicio. En tercer lugar, se utiliza la broca extracorta HSS-E A117 para taladrar un agujero para el extractor. Finalmente, se utiliza el extractor de tornillos con un giro en sentido antihorario para extraer el perno roto sin dañar las roscas.

A=Tipos en el Juego, B=No en el Juego, C=Diámetros en el Juego

Product	Nr.	A	B	C
M902M6-M8	M6-M8	M900, P100, P101, A117	4	P1004.9, P1014.9, A1173.0, M9002
M902M8-M10	M8-M10	M900, P100, P101, A117	4	P1006.4, P1016.4, A1174.0, M9003
M902M10-M12	M10-M12	M900, P100, P101, A117	4	P1007.8, P1017.8, A1174.2, M9003
M902M12-M14	M12-M14	M900, P100, P101, A117	4	P1009.3, P1019.3, A1176.0, M9004
M902M14-M16	M14-M16	M900, P100, P101, A117	4	P10010.7, P10110.7, A1178.0, M9005

A080

DORMER



Expositor de Mostrador Vacío para Brocas

El dispensador se suministra vacío por lo que las brocas se pueden comprar por separado, eligiendo cantidades que se adapten a las ventas en mostrador. Viene en plástico rojo, marcado con el logo de Dormer y una imagen de varias brocas Dormer. Los diámetros de broca métricos o fraccionales están marcados en los tres estantes.

Dispensador de brocas vacío. Diámetros de broca marcados en la caja.

Product	Nr.	C
A080M1EMPTY	M1EMPTY	(1.00, 1.50, 2.00, 2.50, 3.00, 3.50, 4.00, 4.50, 5.00, 5.50, 6.00, 6.50, 7.00, 7.50, 8.00, 8.50, 9.00, 9.50, 10.00, 10.50, 11.00, 11.50, 12.00) mm
A080F1EMPTY	F1EMPTY	(1/16, 5/64, 3/32, 7/64, 1/8, 9/64, 5/32, 11/64, 3/16, 13/64, 7/32, 15/64, 1/4, 17/64, 9/32, 19/64, 5/16, 21/64, 11/32, 3/8, 13/32, 7/16, 1/2) inch



**HERRAMIENTAS PARA FABRICACIÓN MIXTA.
UTILIZADAS NORMALMENTE CON MÁQUINAS
CONVENCIONALES CON AVANCES DE MÁQUINA Y CNC.**

Código de Material (BMC)	HSS-E	HSS	HSS-E	HSS-E	HSS-E	HM							
Grupo básico estándar (BSG)	DIN 1899	DIN 1897	DIN 1897	DIN 1897	DIN ANSI	DIN 6539							
Longitud Útil (ULDR)	2.5xD	2.5xD	2.5xD	2.5xD	3xD	2.5xD							
Ángulo de aplicación	118°	130°	130°	135°	130°	120°							
Recubrimiento	Bright	TiN	Bronze	Bronze	Bright	TiN-Tip							
Mango													
Forma de la Hélice	λ20-35°	λ32-40°	λ20-35°	λ20-35°	λ>35°	λ20-35°							
Mano (dirección de corte)													
		ADX			PFX	NEW							

Código de Familia de Producto		A720	A520	A620	A117	A920	R023						
Gama de diámetros de corte PSF		0.15 - 1.40	3.00 - 13.00	2.50 - 13.00	1.00 - 13.00	1.00 - 20.00	1.00 - 12.00						
		104	105	107	108	110	112						
P	P1	■	■	■	■	■	■						
	P2	■	■	■	■	■	■						
	P3	■	■	■	■	■	■						
	P4	■	■	■	■	■	■						
M	M1	■	■	■	■	■	■						
	M2	■	■	■	■	■	■						
	M3	■	■	■	■	■	■						
	M4	■	■	■	■	■	■						
K	K1	■	■	■	■	■	■						
	K2	■	■	■	■	■	■						
	K3	■	■	■	■	■	■						
	K4	■	■	■	■	■	■						
	K5	■	■	■	■	■	■						
N	N1	■	■	■	■	■	■						
	N2	■	■	■	■	■	■						
	N3	■	■	■	■	■	■						
	N4	■	■	■	■	■	■						
	N5	■	■	■	■	■	■						
S	S1	■	■	■	■	■	■						
	S2	■	■	■	■	■	■						
	S3	■	■	■	■	■	■						
	S4	■	■	■	■	■	■						
H	H1						■						
	H2						■						
	H3						■						
	H4												

A720



Micro Broca HSS-E (5% Cobalto), Acabado Brillante

Micro broca en diámetros muy pequeños que van desde 0,15 mm hasta 1,40 mm. Para facilitar la sujeción de la herramienta, todas las brocas tienen un diámetro de mango de 1,00 mm o 1,50 mm. Todas las brocas tienen punta a 118° y 4 facetas, que favorece el autocentrado y reduce las fuerzas de corte.

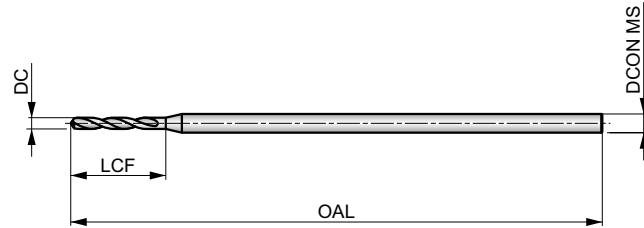

HSS-E	DIN 1899	2.5xD
118°	Bright	
λ 20-35°		

Grupo de Material de la pieza adecuado y condiciones de velocidad de corte iniciales (m/min) y código de avance alfabético. Tablas con avance por revolución a partir de la pag.274.

P1.1 ■ 36 A	P1.2 ■ 40 A	P1.3 ■ 41 A	P2.1 ■ 31 A	P2.2 ■ 27 A	P2.3 ■ 24 A	P3.1 ■ 25 A	P3.2 ■ 20 A	P3.3 ■ 17 A	P4.1 ■ 15 A	P4.2 ■ 13 A	P4.3 ■ 10 A	M1.1 ■ 30 A	M1.2 ■ 26 A
M2.1 ■ 27 A	M2.2 ■ 22 A	M3.1 ■ 12 A	M3.2 ■ 10 A	M3.3 ■ 9 A	M4.1 ■ 15 A	K1.1 ■ 30 A	K1.2 ■ 22 A	K1.3 ■ 17 A	K2.1 ■ 25 A	K2.2 ■ 20 A	K2.3 ■ 16 A	K3.1 ■ 22 A	K3.2 ■ 17 A
K3.3 ■ 13 A	K4.1 ■ 20 A	K4.2 ■ 15 A	K4.3 ■ 11 A	K4.4 ■ 10 A	K4.5 ■ 8 A	K5.1 ■ 23 A	K5.2 ■ 17 A	K5.3 ■ 13 A	N1.1 ■ 35 A	N1.2 ■ 26 A	N1.3 ■ 18 A	N2.1 ■ 42 A	N2.2 ■ 37 A
N2.3 ■ 27 A	N3.1 ■ 68 A	N3.2 ■ 40 A	N3.3 ■ 20 A	N4.1 ■ 48 A	N4.2 ■ 25 A	S1.1 ■ 23 A	S1.2 ■ 17 A	S1.3 ■ 8 A	S2.1 ■ 9 A	S2.2 ■ 6 A	S3.1 ■ 7 A	S3.2 ■ 4 A	S4.1 ■ 5 A
S4.2 ■ 3 A													

Product	DC (mm)	DC (inch)	LCF (mm)	OAL (mm)	DCON MS (mm)
A720.15	0.15	0.0059	1.0	25.0	1.00
A720.18	0.18	0.0070	1.4	25.0	1.00
A720.2	0.20	0.0079	1.8	25.0	1.00
A720.22	0.22	0.0087	1.8	25.0	1.00
A720.25	0.25	0.0098	2.2	25.0	1.00
A720.27	0.27	0.0106	2.2	25.0	1.00
A720.28	0.28	0.0110	2.2	25.0	1.00
A720.3	0.30	0.0118	2.2	25.0	1.00
A720.35	0.35	0.0138	2.8	25.0	1.00
A720.4	0.40	0.0157	3.6	25.0	1.00
A720.45	0.45	0.0177	3.6	25.0	1.00
A720.5	0.50	0.0197	4.0	25.0	1.00
A720.55	0.55	0.0217	4.5	25.0	1.00

Product	DC (mm)	DC (inch)	LCF (mm)	OAL (mm)	DCON MS (mm)
A720.6	0.60	0.0236	4.5	25.0	1.00
A720.62	0.62	0.0244	5.0	25.0	1.00
A720.65	0.65	0.0256	5.0	25.0	1.00
A720.7	0.70	0.0276	5.6	25.0	1.00
A720.75	0.75	0.0295	5.6	25.0	1.00
A720.8	0.80	0.0315	6.3	25.0	1.50
A720.85	0.85	0.0335	6.3	25.0	1.50
A720.9	0.90	0.0354	7.1	25.0	1.50
A720.95	0.95	0.0374	7.1	25.0	1.50
A7201.0	1.00	0.0394	8.0	25.0	1.50
A7201.05	1.05	0.0413	8.0	25.0	1.50
A7201.3	1.30	0.0512	10.0	25.0	1.50
A7201.4	1.40	0.0551	11.2	25.0	1.50

A520



Broca ADX HSS, Serie Extra Corta, con Recubrimiento TiN

Broca de alto rendimiento, capaz de producir agujeros precisos y de alta calidad a altas velocidades y avances (tolerancia de agujero H9). La punta adelgazada a 130° mejora el auto-centrado y reduce las fuerzas de corte. Esta broca se debe utilizar únicamente en máquinas con avance constante. El recubrimiento TiN mejora el rendimiento y prolonga la vida de la herramienta.

ADX

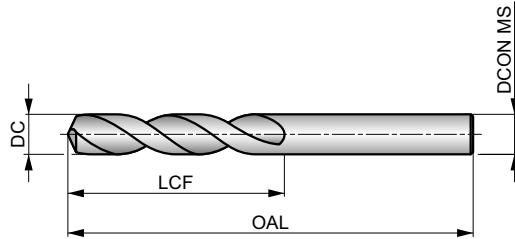

HSS	DIN 1897	2.5xD
130°	TiN	
λ 32-40°	R	DC h8

Grupo de Material de la pieza adecuado y condiciones de velocidad de corte iniciales (m/min) y código de avance alfabético. Tablas con avance por revolución a partir de la pag.274.

P1.1 ■ 53 M	P1.2 ■ 59 M	P1.3 ■ 61 M	P2.1 ■ 45 M	P2.2 ■ 40 K	P2.3 ■ 35 G	P3.1 ■ 31 I	P3.2 ■ 25 I	P3.3 ■ 21 G	P4.1 ■ 19 I	P4.2 ■ 16 G	P4.3 ■ 13 E	M1.1 ■ 41 I	M1.2 ■ 35 I
M2.1 ■ 37 I	M2.2 ■ 30 I	M3.1 ■ 19 I	M3.2 ■ 16 I	M3.3 ■ 14 I	M4.1 ■ 20 G	K1.1 ■ 48 M	K1.2 ■ 36 K	K1.3 ■ 27 K	K2.1 ■ 37 J	K2.2 ■ 30 J	K2.3 ■ 24 F	K3.1 ■ 33 J	K3.2 ■ 25 J
K3.3 ■ 20 F	K4.1 ■ 30 J	K4.2 ■ 23 J	K4.3 ■ 17 F	K4.4 ■ 14 F	K4.5 ■ 12 F	K5.1 ■ 34 J	K5.2 ■ 26 J	K5.3 ■ 20 F	N1.1 ■ 55 I	N1.2 ■ 41 I	N1.3 ■ 28 M	N2.1 ■ 57 K	N2.2 ■ 51 K
N2.3 ■ 37 K	N3.1 ■ 85 K	N3.2 ■ 50 I	N3.3 ■ 25 E	N4.1 ■ 65 G	N4.2 ■ 50 G	N4.3 ■ 35 F	S1.1 ■ 34 I	S1.2 ■ 20 G	S1.3 ■ 4 B	S2.1 ■ 15 G	S2.2 ■ 10 E	S3.1 ■ 11 G	S3.2 ■ 7 E
S4.1 ■ 9 G	S4.2 ■ 16 E												

Product	DC (inch)	DC (mm)	DC (inch)	LCF (mm)	OAL (mm)	DCON MS (mm)
A5203.0	-	3.00	0.1181	16.0	46.0	3.00
A5203.1	-	3.10	0.1220	18.0	49.0	3.10
A5201/8	1/8	3.18	0.1250	18.0	49.0	3.18
A5203.2	-	3.20	0.1260	18.0	49.0	3.20
A5203.3	-	3.30	0.1299	18.0	49.0	3.30
A5203.4	-	3.40	0.1339	20.0	52.0	3.40
A5203.5	-	3.50	0.1378	20.0	52.0	3.50
A5203.6	-	3.60	0.1417	20.0	52.0	3.60
A5203.7	-	3.70	0.1457	20.0	52.0	3.70
A5203.8	-	3.80	0.1496	22.0	55.0	3.80
A5203.9	-	3.90	0.1535	22.0	55.0	3.90
A5204.0	-	4.00	0.1575	22.0	55.0	4.00
A5204.1	-	4.10	0.1614	22.0	55.0	4.10
A5204.2	-	4.20	0.1654	22.0	55.0	4.20
A5204.3	-	4.30	0.1693	24.0	58.0	4.30
A52011/64	11/64	4.37	0.1719	24.0	58.0	4.37
A5204.4	-	4.40	0.1732	24.0	58.0	4.40
A5204.5	-	4.50	0.1772	24.0	58.0	4.50
A5204.6	-	4.60	0.1811	24.0	58.0	4.60
A5204.7	-	4.70	0.1850	24.0	58.0	4.70
A5203/16	3/16	4.76	0.1875	26.0	62.0	4.76
A5204.8	-	4.80	0.1890	26.0	62.0	4.80
A5204.9	-	4.90	0.1929	26.0	62.0	4.90
A5205.0	-	5.00	0.1969	26.0	62.0	5.00

Product	DC (inch)	DC (mm)	DC (inch)	LCF (mm)	OAL (mm)	DCON MS (mm)
A5205.1	-	5.10	0.2008	26.0	62.0	5.10
A5205.2	-	5.20	0.2047	26.0	62.0	5.20
A5205.3	-	5.30	0.2087	26.0	62.0	5.30
A5205.4	-	5.40	0.2126	28.0	66.0	5.40
A5205.5	-	5.50	0.2165	28.0	66.0	5.50
A5207/32	7/32	5.56	0.2188	28.0	66.0	5.56
A5205.6	-	5.60	0.2205	28.0	66.0	5.60
A5205.7	-	5.70	0.2244	28.0	66.0	5.70
A5205.8	-	5.80	0.2283	28.0	66.0	5.80
A5205.9	-	5.90	0.2323	28.0	66.0	5.90
A5206.0	-	6.00	0.2362	28.0	66.0	6.00
A5206.1	-	6.10	0.2402	31.0	70.0	6.10
A5206.2	-	6.20	0.2441	31.0	70.0	6.20
A5206.3	-	6.30	0.2480	31.0	70.0	6.30
A5201/4	1/4	6.35	0.2500	31.0	70.0	6.35
A5206.4	-	6.40	0.2520	31.0	70.0	6.40
A5206.5	-	6.50	0.2559	31.0	70.0	6.50
A5206.6	-	6.60	0.2598	31.0	70.0	6.60
A5206.7	-	6.70	0.2638	31.0	70.0	6.70
A52017/64	17/64	6.75	0.2656	34.0	74.0	6.75
A5206.8	-	6.80	0.2677	34.0	74.0	6.80
A5206.9	-	6.90	0.2717	34.0	74.0	6.90
A5207.0	-	7.00	0.2756	34.0	74.0	7.00
A5207.1	-	7.10	0.2795	34.0	74.0	7.10



Product	DC	DC	DC	LCF	OAL	DCON MS
	(inch)	(mm)	(inch)	(mm)	(mm)	(mm)
A5209/32	9/32	7.14	0.2813	34.0	74.0	7.14
A5207.2	–	7.20	0.2835	34.0	74.0	7.20
A5207.4	–	7.40	0.2913	34.0	74.0	7.40
A5207.5	–	7.50	0.2953	34.0	74.0	7.50
A5207.8	–	7.80	0.3071	37.0	79.0	7.80
A5207.9	–	7.90	0.3110	37.0	79.0	7.90
A5205/16	5/16	7.94	0.3125	37.0	79.0	7.94
A5208.0	–	8.00	0.3150	37.0	79.0	8.00
A5208.1	–	8.10	0.3189	37.0	79.0	8.10
A5208.2	–	8.20	0.3228	37.0	79.0	8.20
A5208.3	–	8.30	0.3268	37.0	79.0	8.30
A5208.4	–	8.40	0.3307	37.0	79.0	8.40
A5208.5	–	8.50	0.3346	37.0	79.0	8.50
A5208.6	–	8.60	0.3386	40.0	84.0	8.60
A5208.7	–	8.70	0.3425	40.0	84.0	8.70
A52011/32	11/32	8.73	0.3438	40.0	84.0	8.73
A5208.8	–	8.80	0.3465	40.0	84.0	8.80
A5209.0	–	9.00	0.3543	40.0	84.0	9.00
A5209.1	–	9.10	0.3583	40.0	84.0	9.10
A5209.5	–	9.50	0.3740	40.0	84.0	9.50
A5203/8	3/8	9.52	0.3750	43.0	89.0	9.52
A5209.6	–	9.60	0.3780	43.0	89.0	9.60
A5209.7	–	9.70	0.3819	43.0	89.0	9.70
A52025/64	25/64	9.92	0.3906	43.0	89.0	9.92

Product	DC	DC	DC	LCF	OAL	DCON MS
	(inch)	(mm)	(inch)	(mm)	(mm)	(mm)
A52010.0	–	10.00	0.3937	43.0	89.0	10.00
A52010.1	–	10.10	0.3976	43.0	89.0	10.10
A52010.2	–	10.20	0.4016	43.0	89.0	10.20
A52010.3	–	10.30	0.4055	43.0	89.0	10.30
A52013/32	13/32	10.32	0.4063	43.0	89.0	10.32
A52010.5	–	10.50	0.4134	43.0	89.0	10.50
A52027/64	27/64	10.72	0.4219	47.0	95.0	10.72
A52010.8	–	10.80	0.4252	47.0	95.0	10.80
A52011.0	–	11.00	0.4331	47.0	95.0	11.00
A52011.1	–	11.10	0.4370	47.0	95.0	11.10
A5207/16	7/16	11.11	0.4375	47.0	95.0	11.11
A52011.3	–	11.30	0.4449	47.0	95.0	11.30
A52011.5	–	11.50	0.4528	47.0	95.0	11.50
A52011.7	–	11.70	0.4606	47.0	95.0	11.70
A52011.8	–	11.80	0.4646	47.0	95.0	11.80
A52012.0	–	12.00	0.4724	51.0	102.0	12.00
A52012.1	–	12.10	0.4764	51.0	102.0	12.10
A52012.2	–	12.20	0.4803	51.0	102.0	12.20
A52031/64	31/64	12.30	0.4844	51.0	102.0	12.30
A52012.5	–	12.50	0.4921	51.0	102.0	12.50
A5201/2	1/2	12.70	0.5000	51.0	102.0	12.70
A52012.8	–	12.80	0.5039	51.0	102.0	12.80
A52013.0	–	13.00	0.5118	51.0	102.0	13.00

A620



Broca HSS-E (5% Cobalto), Serie Extra Corta, Acabado Bronce Templado

Broca con un ángulo de 130 ° que mejora el autocentrado y reduce las fuerzas de corte. El acabado bronce consiste en una fina capa de óxido y es un indicativo de cobalto. Adecuada para taladrar en muchos materiales. No debe usarse en máquinas portátiles.

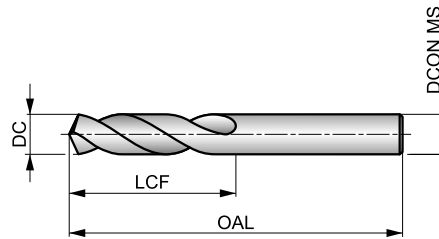

HSS-E	DIN 1897	2.5xD
130°	Bronze	
λ 20-35°	R	DC h8

Grupo de Material de la pieza adecuado y condiciones de velocidad de corte iniciales (m/min) y código de avance alfabético. Tablas con avance por revolución a partir de la pag.274.

P1.1 ■40 H	P1.2 ■45 H	P1.3 ■46 H	P2.1 ■34 H	P2.2 ■30 G	P2.3 ■27 F	P3.1 ■27 G	P3.2 ■21 G	P3.3 ■18 F	P4.1 ■16 G	P4.2 ■13 F	P4.3 ■11 E	M1.1 ■30 F	M1.2 ■26 F
M2.1 ■27 F	M2.2 ■22 F	M3.1 ■13 H	M3.2 ■11 H	M3.3 ■10 H	M4.1 ■15 D	K1.1 ■34 K	K1.2 ■25 F	K1.3 ■19 F	K2.1 ■27 F	K2.2 ■22 F	K2.3 ■18 F	K3.1 ■24 F	K3.2 ■18 F
K3.3 ■15 F	K4.1 ■22 F	K4.2 ■17 F	K4.3 ■12 F	K4.4 ■11 F	K4.5 ■9 F	K5.1 ■25 F	K5.2 ■19 F	K5.3 ■15 F	N1.1 ■40 K	N1.2 ■30 K	N1.3 ■20 J	N2.1 ■49 I	N2.2 ■44 I
N2.3 ■32 I	N3.1 ■68 J	N3.2 ■40 K	N3.3 ■20 I	N4.1 ■40 L	N4.2 ■32 K	N4.3 ■18 I	S1.1 ■30 G	S1.2 ■18 F	S1.3 ■10 C	S2.1 ■12 F	S2.2 ■8 C	S3.1 ■9 F	S3.2 ■6 C
S4.1 ■7 F	S4.2 ■5 C												

Product	DC (mm)	DC (inch)	LCF (mm)	OAL (mm)	DCON MS (mm)
A6202.5	2.50	0.0984	14.0	43.0	2.50
A6202.6	2.60	0.1024	14.0	43.0	2.60
A6202.7	2.70	0.1063	16.0	46.0	2.70
A6202.8	2.80	0.1102	16.0	46.0	2.80
A6202.9	2.90	0.1142	16.0	46.0	2.90
A6203.0	3.00	0.1181	16.0	46.0	3.00
A6203.1	3.10	0.1220	18.0	49.0	3.10
A6203.2	3.20	0.1260	18.0	49.0	3.20
A6203.3	3.30	0.1299	18.0	49.0	3.30
A6203.4	3.40	0.1339	20.0	52.0	3.40
A6203.5	3.50	0.1378	20.0	52.0	3.50
A6204.0	4.00	0.1575	22.0	55.0	4.00
A6204.1	4.10	0.1614	22.0	55.0	4.10
A6204.2	4.20	0.1654	22.0	55.0	4.20
A6204.3	4.30	0.1693	24.0	58.0	4.30
A6204.5	4.50	0.1772	24.0	58.0	4.50
A6204.7	4.70	0.1850	24.0	58.0	4.70
A6204.9	4.90	0.1929	26.0	62.0	4.90
A6205.0	5.00	0.1969	26.0	62.0	5.00
A6205.1	5.10	0.2008	26.0	62.0	5.10
A6205.2	5.20	0.2047	26.0	62.0	5.20
A6205.3	5.30	0.2087	26.0	62.0	5.30
A6205.5	5.50	0.2165	28.0	66.0	5.50
A6205.6	5.60	0.2205	28.0	66.0	5.60
A6206.0	6.00	0.2362	28.0	66.0	6.00

Product	DC (mm)	DC (inch)	LCF (mm)	OAL (mm)	DCON MS (mm)
A6206.2	6.20	0.2441	31.0	70.0	6.20
A6206.3	6.30	0.2480	31.0	70.0	6.30
A6206.5	6.50	0.2559	31.0	70.0	6.50
A6206.8	6.80	0.2677	34.0	74.0	6.80
A6206.9	6.90	0.2717	34.0	74.0	6.90
A6207.0	7.00	0.2756	34.0	74.0	7.00
A6207.5	7.50	0.2953	34.0	74.0	7.50
A6207.8	7.80	0.3071	37.0	79.0	7.80
A6208.0	8.00	0.3150	37.0	79.0	8.00
A6208.2	8.20	0.3228	37.0	79.0	8.20
A6208.5	8.50	0.3346	37.0	79.0	8.50
A6208.7	8.70	0.3425	40.0	84.0	8.70
A6209.0	9.00	0.3543	40.0	84.0	9.00
A6209.5	9.50	0.3740	40.0	84.0	9.50
A62010.0	10.00	0.3937	43.0	89.0	10.00
A62010.2	10.20	0.4016	43.0	89.0	10.20
A62010.3	10.30	0.4055	43.0	89.0	10.30
A62010.5	10.50	0.4134	43.0	89.0	10.50
A62010.8	10.80	0.4252	47.0	95.0	10.80
A62011.0	11.00	0.4331	47.0	95.0	11.00
A62011.5	11.50	0.4528	47.0	95.0	11.50
A62012.0	12.00	0.4724	51.0	102.0	12.00
A62012.5	12.50	0.4921	51.0	102.0	12.50
A62013.0	13.00	0.5118	51.0	102.0	13.00

A117



Broca HSS-E (8% Co), Serie Extra Corta, Acabado Bronce Templado

Broca recomendada para uso en materiales y aplicaciones difíciles. La punta dividida y a 135° facilita el auto-centrado y reduce las fuerzas de corte. Fiable para producir un agujero preciso y un acabado de calidad. El acabado bronce consiste en una fina capa de óxido y es indicativo de cobalto.

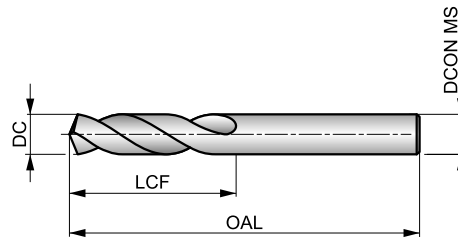

HSS-E	DIN 1897	2.5xD
135°	Bronze	
λ 20-35°	R	DC h8

Grupo de Material de la pieza adecuado y condiciones de velocidad de corte iniciales (m/min) y código de avance alfabético. Tablas con avance por revolución a partir de la pag.274.

P1.1 ■ 40 H	P1.2 ■ 45 H	P1.3 ■ 46 H	P2.1 ■ 34 H	P2.2 ■ 30 G	P2.3 ■ 27 F	P3.1 ■ 27 G	P3.2 ■ 21 G	P3.3 ■ 18 F	P4.1 ■ 16 G	P4.2 ■ 13 F	P4.3 ■ 11 E	M1.1 ■ 30 F	M1.2 ■ 26 F
M2.1 ■ 27 F	M2.2 ■ 22 F	M3.1 ■ 13 H	M3.2 ■ 11 H	M3.3 ■ 10 H	M4.1 ■ 15 D	K1.1 ■ 34 K	K1.2 ■ 25 F	K1.3 ■ 19 F	K2.1 ■ 27 F	K2.2 ■ 22 F	K2.3 ■ 18 F	K3.1 ■ 24 F	K3.2 ■ 18 F
K3.3 ■ 15 F	K4.1 ■ 22 F	K4.2 ■ 17 F	K4.3 ■ 12 F	K4.4 ■ 11 F	K4.5 ■ 9 F	K5.1 ■ 25 F	K5.2 ■ 19 F	K5.3 ■ 15 F	N1.1 ■ 35 K	N1.2 ■ 26 K	N1.3 ■ 18 J	N2.1 ■ 48 I	N2.2 ■ 43 I
N2.3 ■ 31 I	N3.1 ■ 68 J	N3.2 ■ 40 K	N3.3 ■ 20 I	N4.1 ■ 35 M	N4.2 ■ 28 K	N4.3 ■ 17 I	S1.1 ■ 30 G	S1.2 ■ 18 F	S1.3 ■ 10 C	S2.1 ■ 12 F	S2.2 ■ 8 C	S3.1 ■ 9 F	S3.2 ■ 6 C
S4.1 ■ 7 F	S4.2 ■ 5 C												

DC <= 1.5mm punta de 118°; DC < 3.00 mm 5% cobalto.

Product	DC (inch)	DC (mm)	DC (inch)	LCF (mm)	OAL (mm)	DCON MS (mm)
A1171.0	-	1.00	0.0394	6.0	26.0	1.00
A1171.1	-	1.10	0.0433	7.0	28.0	1.10
A1171.2	-	1.20	0.0472	8.0	30.0	1.20
A1171.3	-	1.30	0.0512	8.0	30.0	1.30
A1171.4	-	1.40	0.0551	9.0	32.0	1.40
A1171.5	-	1.50	0.0591	9.0	32.0	1.50
A1171.6	-	1.60	0.0630	10.0	34.0	1.60
A1171.7	-	1.70	0.0669	10.0	34.0	1.70
A1171.8	-	1.80	0.0709	11.0	36.0	1.80
A1171.9	-	1.90	0.0748	11.0	36.0	1.90
A1172.0	-	2.00	0.0787	12.0	38.0	2.00
A1172.1	-	2.10	0.0827	12.0	38.0	2.10
A1172.2	-	2.20	0.0866	13.0	40.0	2.20
A1172.3	-	2.30	0.0906	13.0	40.0	2.30
A1172.4	-	2.40	0.0945	14.0	43.0	2.40
A1172.5	-	2.50	0.0984	14.0	43.0	2.50
A1172.6	-	2.60	0.1024	14.0	43.0	2.60
A1172.7	-	2.70	0.1063	16.0	46.0	2.70
A1172.8	-	2.80	0.1102	16.0	46.0	2.80
A1172.9	-	2.90	0.1142	16.0	46.0	2.90
A1173.0	-	3.00	0.1181	16.0	46.0	3.00
A1173.1	-	3.10	0.1220	18.0	49.0	3.10
A1171/8	1/8	3.18	0.1250	18.0	49.0	3.18

Product	DC (inch)	DC (mm)	DC (inch)	LCF (mm)	OAL (mm)	DCON MS (mm)
A1173.2	-	3.20	0.1260	18.0	49.0	3.20
A1173.3	-	3.30	0.1299	18.0	49.0	3.30
A1173.4	-	3.40	0.1339	20.0	52.0	3.40
A1173.5	-	3.50	0.1378	20.0	52.0	3.50
A1173.6	-	3.60	0.1417	20.0	52.0	3.60
A1173.7	-	3.70	0.1457	20.0	52.0	3.70
A1173.8	-	3.80	0.1496	22.0	55.0	3.80
A1173.9	-	3.90	0.1535	22.0	55.0	3.90
A1175/32	5/32	3.97	0.1563	22.0	55.0	3.97
A1174.0	-	4.00	0.1575	22.0	55.0	4.00
A1174.1	-	4.10	0.1614	22.0	55.0	4.10
A1174.2	-	4.20	0.1654	22.0	55.0	4.20
A1174.3	-	4.30	0.1693	24.0	58.0	4.30
A1174.4	-	4.40	0.1732	24.0	58.0	4.40
A1174.5	-	4.50	0.1772	24.0	58.0	4.50
A1174.6	-	4.60	0.1811	24.0	58.0	4.60
A1174.7	-	4.70	0.1850	24.0	58.0	4.70
A1173/16	3/16	4.76	0.1875	26.0	62.0	4.76
A1174.8	-	4.80	0.1890	26.0	62.0	4.80
A1174.9	-	4.90	0.1929	26.0	62.0	4.90
A1175.0	-	5.00	0.1969	26.0	62.0	5.00
A1175.1	-	5.10	0.2008	26.0	62.0	5.10
A1175.2	-	5.20	0.2047	26.0	62.0	5.20



Product	DC	DC	DC	LCF	OAL	DCON MS
	(inch)	(mm)	(inch)	(mm)	(mm)	(mm)
A1175.3	–	5.30	0.2087	26.0	62.0	5.30
A1175.4	–	5.40	0.2126	28.0	66.0	5.40
A1175.5	–	5.50	0.2165	28.0	66.0	5.50
A1175.6	–	5.60	0.2205	28.0	66.0	5.60
A1175.7	–	5.70	0.2244	28.0	66.0	5.70
A1175.8	–	5.80	0.2283	28.0	66.0	5.80
A1175.9	–	5.90	0.2323	28.0	66.0	5.90
A1176.0	–	6.00	0.2362	28.0	66.0	6.00
A1176.1	–	6.10	0.2402	31.0	70.0	6.10
A1176.2	–	6.20	0.2441	31.0	70.0	6.20
A1176.3	–	6.30	0.2480	31.0	70.0	6.30
A1171/4	1/4	6.35	0.2500	31.0	70.0	6.35
A1176.4	–	6.40	0.2520	31.0	70.0	6.40
A1176.5	–	6.50	0.2559	31.0	70.0	6.50
A1176.6	–	6.60	0.2598	31.0	70.0	6.60
A1176.7	–	6.70	0.2638	31.0	70.0	6.70
A1176.8	–	6.80	0.2677	34.0	74.0	6.80
A1176.9	–	6.90	0.2717	34.0	74.0	6.90
A1177.0	–	7.00	0.2756	34.0	74.0	7.00
A1177.1	–	7.10	0.2795	34.0	74.0	7.10
A1177.2	–	7.20	0.2835	34.0	74.0	7.20
A1177.3	–	7.30	0.2874	34.0	74.0	7.30
A1177.4	–	7.40	0.2913	34.0	74.0	7.40
A1177.5	–	7.50	0.2953	34.0	74.0	7.50
A1177.6	–	7.60	0.2992	37.0	79.0	7.60
A1177.7	–	7.70	0.3031	37.0	79.0	7.70
A1177.8	–	7.80	0.3071	37.0	79.0	7.80

Product	DC	DC	DC	LCF	OAL	DCON MS
	(inch)	(mm)	(inch)	(mm)	(mm)	(mm)
A1177.9	–	7.90	0.3110	37.0	79.0	7.90
A1175/16	5/16	7.94	0.3125	37.0	79.0	7.94
A1178.0	–	8.00	0.3150	37.0	79.0	8.00
A1178.1	–	8.10	0.3189	37.0	79.0	8.10
A1178.2	–	8.20	0.3228	37.0	79.0	8.20
A1178.3	–	8.30	0.3268	37.0	79.0	8.30
A1178.4	–	8.40	0.3307	37.0	79.0	8.40
A1178.5	–	8.50	0.3346	37.0	79.0	8.50
A1178.6	–	8.60	0.3386	40.0	84.0	8.60
A1178.7	–	8.70	0.3425	40.0	84.0	8.70
A1178.8	–	8.80	0.3465	40.0	84.0	8.80
A1178.9	–	8.90	0.3504	40.0	84.0	8.90
A1179.0	–	9.00	0.3543	40.0	84.0	9.00
A1179.1	–	9.10	0.3583	40.0	84.0	9.10
A1179.2	–	9.20	0.3622	40.0	84.0	9.20
A1179.3	–	9.30	0.3661	40.0	84.0	9.30
A1179.5	–	9.50	0.3740	40.0	84.0	9.50
A1179.9	–	9.90	0.3898	43.0	89.0	9.90
A11710.0	–	10.00	0.3937	43.0	89.0	10.00
A11710.2	–	10.20	0.4016	43.0	89.0	10.20
A11710.5	–	10.50	0.4134	43.0	89.0	10.50
A11711.0	–	11.00	0.4331	47.0	95.0	11.00
A11711.5	–	11.50	0.4528	47.0	95.0	11.50
A11712.0	–	12.00	0.4724	51.0	102.0	12.00
A1171/2	1/2	12.70	0.5000	51.0	102.0	12.70
A11713.0	–	13.00	0.5118	51.0	102.0	13.00

A920



Broca PFX HSS-E (5% Cobalto), Serie Extra Corta, Acabado Brillante

Broca de alto rendimiento, capaz de producir agujeros precisos y de alta calidad a altas velocidades y avances (tolerancia de agujero H10). La punta autocentrante a 130° y el diseño especial parabólico de los canales ayudan a taladrar agujeros profundos en una sola pasada. Apta para la mayoría de materiales.



PFX

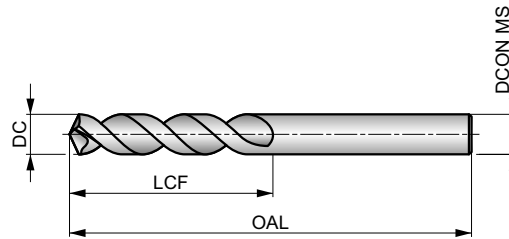

HSS-E	DIN ANSI	3×D
	Bright	
		DC h8

Grupo de Material de la pieza adecuado y condiciones de velocidad de corte iniciales (m/min) y código de avance alfabético. Tablas con avance por revolución a partir de la pag.274.

P1.1 ■ 42 J	P1.2 ■ 47 J	P1.3 ■ 49 J	P2.1 ■ 36 J	P2.2 ■ 32 I	P2.3 ■ 28 E	P3.1 ■ 34 I	P3.2 ■ 27 I	P3.3 ■ 23 E	P4.1 ■ 20 I	P4.2 ■ 17 E	P4.3 ■ 14 E	M1.1 ■ 21 F	M1.2 ■ 17 F
M2.1 ■ 18 F	M2.2 ■ 15 F	M3.1 ■ 8 F	M3.2 ■ 7 F	M3.3 ■ 6 F	M4.1 ■ 9 D	K1.1 □ 34 L	K1.2 □ 25 L	K1.3 □ 19 L	K2.1 □ 32 L	K2.2 □ 26 L	K2.3 □ 21 J	K3.1 □ 28 L	K3.2 □ 22 L
K3.3 □ 17 J	K4.1 □ 26 L	K4.2 □ 20 L	K4.3 □ 14 J	K4.4 □ 12 J	K4.5 □ 10 J	K5.1 □ 30 L	K5.2 □ 22 L	K5.3 □ 17 J	N1.1 □ 75 L	N1.2 □ 56 L	N1.3 □ 38 N	N2.1 □ 62 N	N2.2 □ 55 N
N2.3 □ 40 N	N3.1 □ 112 J	N3.2 □ 66 J	N3.3 □ 33 H	N4.1 □ 55 J	N4.2 □ 40 H	S1.1 ■ 30 G	S1.2 ■ 18 G	S1.3 ■ 10 C	S2.1 ■ 12 G	S2.2 ■ 8 E	S3.1 ■ 9 G	S3.2 ■ 6 E	S4.1 ■ 7 G
S4.2 ■ 5 E													

Product	DC (inch)	DC (mm)	DC (inch)	LCF (mm)	OAL (mm)	DCON MS (mm)
A9201.0	–	1.00	0.0394	6.0	26.0	1.00
A9203/64	3/64	1.19	0.0469	13.0	35.0	1.19
A9201.2	–	1.20	0.0472	8.0	30.0	1.20
A9201.25	–	1.25	0.0492	8.0	30.0	1.25
A9201.3	–	1.30	0.0512	8.0	30.0	1.30
A9201.35	–	1.35	0.0531	9.0	32.0	1.35
A9201.4	–	1.40	0.0551	9.0	32.0	1.40
A9201.5	–	1.50	0.0591	9.0	32.0	1.50
A9201.55	–	1.55	0.0610	10.0	34.0	1.55
A9201/16	1/16	1.59	0.0625	16.0	41.0	1.59
A9201.6	–	1.60	0.0630	10.0	34.0	1.60
A9201.7	–	1.70	0.0669	10.0	34.0	1.70
A9201.8	–	1.80	0.0709	11.0	36.0	1.80
A9201.9	–	1.90	0.0748	11.0	36.0	1.90
A9205/64	5/64	1.98	0.0781	17.0	43.0	1.98
A9202.0	–	2.00	0.0787	12.0	38.0	2.00
A9202.1	–	2.10	0.0827	12.0	38.0	2.10
A9202.15	–	2.15	0.0846	13.0	40.0	2.15
A9202.2	–	2.20	0.0866	13.0	40.0	2.20
A9202.3	–	2.30	0.0906	13.0	40.0	2.30
A9202.35	–	2.35	0.0925	14.0	43.0	2.35
A9203/32	3/32	2.38	0.0938	19.0	41.0	2.38
A9202.4	–	2.40	0.0945	14.0	43.0	2.40
A9202.5	–	2.50	0.0984	14.0	43.0	2.50

Product	DC (inch)	DC (mm)	DC (inch)	LCF (mm)	OAL (mm)	DCON MS (mm)
A9202.6	–	2.60	0.1024	14.0	43.0	2.60
A9202.7	–	2.70	0.1063	16.0	46.0	2.70
A9207/64	7/64	2.78	0.1094	21.0	46.0	2.78
A9202.8	–	2.80	0.1102	16.0	46.0	2.80
A9202.9	–	2.90	0.1142	16.0	46.0	2.90
A9203.0	–	3.00	0.1181	16.0	46.0	3.00
A9203.1	–	3.10	0.1220	18.0	49.0	3.10
A9201/8	1/8	3.18	0.1250	22.0	48.0	3.18
A9203.2	–	3.20	0.1260	18.0	49.0	3.20
A9203.3	–	3.30	0.1299	18.0	49.0	3.30
A9203.4	–	3.40	0.1339	20.0	52.0	3.40
A9203.5	–	3.50	0.1378	20.0	52.0	3.50
A9209/64	9/64	3.57	0.1406	24.0	49.0	3.57
A9203.6	–	3.60	0.1417	20.0	52.0	3.60
A9203.7	–	3.70	0.1457	20.0	52.0	3.70
A9203.8	–	3.80	0.1496	22.0	55.0	3.80
A9205/32	5/32	3.97	0.1563	25.0	52.0	3.97
A9204.0	–	4.00	0.1575	22.0	55.0	4.00
A9204.1	–	4.10	0.1614	22.0	55.0	4.10
A9204.2	–	4.20	0.1654	22.0	55.0	4.20
A9204.3	–	4.30	0.1693	24.0	58.0	4.30
A92011/64	11/64	4.37	0.1719	27.0	54.0	4.37
A9204.4	–	4.40	0.1732	24.0	58.0	4.40
A9204.5	–	4.50	0.1772	24.0	58.0	4.50

Product	DC	DC	DC	LCF	OAL	D CON MS
	(inch)	(mm)	(inch)	(mm)	(mm)	(mm)
A9204.6	–	4.60	0.1811	24.0	58.0	4.60
A9203/16	3/16	4.76	0.1875	29.0	56.0	4.76
A9204.8	–	4.80	0.1890	26.0	62.0	4.80
A9204.9	–	4.90	0.1929	26.0	62.0	4.90
A9205.0	–	5.00	0.1969	26.0	62.0	5.00
A9205.1	–	5.10	0.2008	26.0	62.0	5.10
A92013/64	13/64	5.16	0.2031	30.0	57.0	5.16
A9205.2	–	5.20	0.2047	26.0	62.0	5.20
A9205.3	–	5.30	0.2087	26.0	62.0	5.30
A9205.4	–	5.40	0.2126	28.0	66.0	5.40
A9205.5	–	5.50	0.2165	28.0	66.0	5.50
A9207/32	7/32	5.56	0.2188	32.0	60.0	5.56
A9205.6	–	5.60	0.2205	28.0	66.0	5.60
A9205.7	–	5.70	0.2244	28.0	66.0	5.70
A9205.9	–	5.90	0.2323	28.0	66.0	5.90
A9206.0	–	6.00	0.2362	28.0	66.0	6.00
A9206.2	–	6.20	0.2441	31.0	70.0	6.20
A9201/4	1/4	6.35	0.2500	35.0	64.0	6.35
A9206.4	–	6.40	0.2520	31.0	70.0	6.40
A9206.5	–	6.50	0.2559	31.0	70.0	6.50
A9206.6	–	6.60	0.2598	31.0	70.0	6.60
A9206.7	–	6.70	0.2638	31.0	70.0	6.70
A92017/64	17/64	6.75	0.2656	37.0	67.0	6.75
A9206.8	–	6.80	0.2677	34.0	74.0	6.80
A9206.9	–	6.90	0.2717	34.0	74.0	6.90
A9207.0	–	7.00	0.2756	34.0	74.0	7.00
A9207.1	–	7.10	0.2795	34.0	74.0	7.10
A9209/32	9/32	7.14	0.2813	38.0	68.0	7.14
A9207.5	–	7.50	0.2953	34.0	74.0	7.50
A92019/64	19/64	7.54	0.2969	40.0	70.0	7.54
A9207.8	–	7.80	0.3071	37.0	79.0	7.80
A9205/16	5/16	7.94	0.3125	41.0	71.0	7.94
A9208.0	–	8.00	0.3150	37.0	79.0	8.00
A9208.3	–	8.30	0.3268	37.0	79.0	8.30

Product	DC	DC	DC	LCF	OAL	D CON MS
	(inch)	(mm)	(inch)	(mm)	(mm)	(mm)
A9208.4	–	8.40	0.3307	37.0	79.0	8.40
A9208.5	–	8.50	0.3346	37.0	79.0	8.50
A9208.6	–	8.60	0.3386	40.0	84.0	8.60
A9208.7	–	8.70	0.3425	40.0	84.0	8.70
A9209.0	–	9.00	0.3543	40.0	84.0	9.00
A9209.5	–	9.50	0.3740	40.0	84.0	9.50
A9203/8	3/8	9.52	0.3750	46.0	79.0	9.52
A92025/64	25/64	9.92	0.3906	48.0	83.0	9.92
A92010.0	–	10.00	0.3937	43.0	89.0	10.00
A92010.2	–	10.20	0.4016	43.0	89.0	10.20
A92010.3	–	10.30	0.4055	43.0	89.0	10.30
A92010.5	–	10.50	0.4134	43.0	89.0	10.50
A92027/64	27/64	10.72	0.4219	51.0	86.0	10.72
A92010.8	–	10.80	0.4252	47.0	95.0	10.80
A92011.0	–	11.00	0.4331	47.0	95.0	11.00
A9207/16	7/16	11.11	0.4375	52.0	87.0	11.11
A92011.5	–	11.50	0.4528	47.0	95.0	11.50
A92011.8	–	11.80	0.4646	47.0	95.0	11.80
A92012.0	–	12.00	0.4724	51.0	102.0	12.00
A92012.5	–	12.50	0.4921	51.0	102.0	12.50
A9201/2	1/2	12.70	0.5000	57.0	95.0	12.70
A92013.0	–	13.00	0.5118	51.0	102.0	13.00
A92014.0	–	14.00	0.5512	54.0	107.0	14.00
A92014.5	–	14.50	0.5709	56.0	111.0	14.50
A92016.0	–	16.00	0.6299	58.0	115.0	16.00
A92016.5	–	16.50	0.6496	60.0	119.0	16.50
A92021/32	21/32	16.67	0.6563	73.0	114.0	16.67
A92017.0	–	17.00	0.6693	60.0	119.0	17.00
A92017.5	–	17.50	0.6890	62.0	123.0	17.50
A92018.0	–	18.00	0.7087	62.0	123.0	18.00
A92023/32	23/32	18.26	0.7188	76.0	121.0	18.26
A92019.0	–	19.00	0.7480	64.0	127.0	19.00
A92025/32	25/32	19.84	0.7813	83.0	130.0	19.84
A92020.0	–	20.00	0.7874	66.0	131.0	20.00

R023



Broca de metal duro extra corta, punta recubierta de TiN

Broca básica y versátil con ángulo de punta de 120° y geometría de punta dividida en cuatro facetas para reducir la fuerza de empuje. Tecnología CTW para mejorar la velocidad de taladrado. El recubrimiento TiN de la punta mejora el rendimiento y prolonga la vida útil de la herramienta. Adecuada para máquinas CNC y convencionales en el taladrado de una amplia gama de materiales.

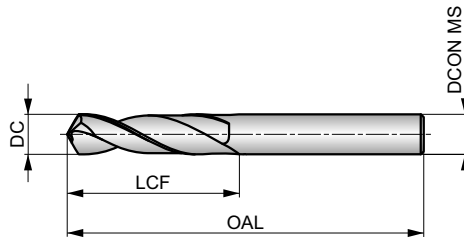

HM	DIN 6539	2.5xD
120°	TiN-Tip	
λ 20-35°	R	DC h7

Grupo de Material de la pieza adecuado y condiciones de velocidad de corte iniciales (m/min) y código de avance alfabético. Tablas con avance por revolución a partir de la pag.274.

P1.1 ■ 99 T	P1.2 ■ 111 T	P1.3 ■ 115 T	P2.1 ■ 85 T	P2.2 ■ 75 T	P2.3 ■ 66 T	P3.1 ■ 66 T	P3.2 ■ 53 T	P3.3 ■ 45 T	P4.1 ■ 40 S	P4.2 ■ 34 S	P4.3 ■ 27 S	K1.1 ■ 75 U	K1.2 ■ 56 U
K1.3 ■ 42 U	K2.1 ■ 68 U	K2.2 ■ 55 U	K2.3 ■ 44 U	K3.1 ■ 60 U	K3.2 ■ 46 U	K3.3 ■ 37 U	K4.1 ■ 55 T	K4.2 ■ 42 T	K4.3 ■ 31 T	K4.4 ■ 26 T	K4.5 ■ 22 T	K5.1 ■ 63 U	K5.2 ■ 47 U
K5.3 ■ 37 U	N1.1 ■ 150 W	N1.2 ■ 113 W	N1.3 ■ 75 W	N2.1 ■ 129 W	N2.2 ■ 116 W	N2.3 ■ 84 W	N3.1 ■ 317 W	N3.2 ■ 190 W	N4.1 ■ 60 V	N4.2 ■ 100 V	H1.1 ■ 34 S	H2.1 ■ 20 S	H3.1 ■ 22 S

Product	DC (mm)	DC (inch)	LCF (mm)	OAL (mm)	DCON MS (mm)
R0231.0	1.00	0.0394	6.0	26.0	1.00
R0231.1	1.10	0.0433	7.0	28.0	1.10
R0231.2	1.20	0.0472	8.0	30.0	1.20
R0231.3	1.30	0.0512	8.0	30.0	1.30
R0231.4	1.40	0.0551	9.0	32.0	1.40
R0231.5	1.50	0.0591	9.0	32.0	1.50
R0231.6	1.60	0.0630	10.0	34.0	1.60
R0231.7	1.70	0.0669	10.0	34.0	1.70
R0231.8	1.80	0.0709	11.0	36.0	1.80
R0231.9	1.90	0.0748	11.0	36.0	1.90
R0232.0	2.00	0.0787	12.0	38.0	2.00
R0232.1	2.10	0.0827	12.0	38.0	2.10
R0232.2	2.20	0.0866	13.0	40.0	2.20
R0232.3	2.30	0.0906	13.0	40.0	2.30
R0232.4	2.40	0.0945	14.0	43.0	2.40
R0232.5	2.50	0.0984	14.0	43.0	2.50
R0232.6	2.60	0.1024	14.0	43.0	2.60
R0232.7	2.70	0.1063	16.0	46.0	2.70
R0232.8	2.80	0.1102	16.0	46.0	2.80
R0232.9	2.90	0.1142	16.0	46.0	2.90
R0233.0	3.00	0.1181	16.0	46.0	3.00
R0233.1	3.10	0.1220	18.0	49.0	3.10
R0233.2	3.20	0.1260	18.0	49.0	3.20
R0233.3	3.30	0.1299	18.0	49.0	3.30
R0233.4	3.40	0.1339	20.0	52.0	3.40
R0233.5	3.50	0.1378	20.0	52.0	3.50
R0233.6	3.60	0.1417	20.0	52.0	3.60
R0233.7	3.70	0.1457	20.0	52.0	3.70

Product	DC (mm)	DC (inch)	LCF (mm)	OAL (mm)	DCON MS (mm)
R0233.8	3.80	0.1496	22.0	55.0	3.80
R0233.9	3.90	0.1535	22.0	55.0	3.90
R0234.0	4.00	0.1575	22.0	55.0	4.00
R0234.1	4.10	0.1614	22.0	55.0	4.10
R0234.2	4.20	0.1654	22.0	55.0	4.20
R0234.3	4.30	0.1693	24.0	58.0	4.30
R0234.4	4.40	0.1732	24.0	58.0	4.40
R0234.5	4.50	0.1772	24.0	58.0	4.50
R0234.6	4.60	0.1811	24.0	58.0	4.60
R0234.7	4.70	0.1850	24.0	58.0	4.70
R0234.8	4.80	0.1890	26.0	62.0	4.80
R0234.9	4.90	0.1929	26.0	62.0	4.90
R0235.0	5.00	0.1969	26.0	62.0	5.00
R0235.1	5.10	0.2008	26.0	62.0	5.10
R0235.2	5.20	0.2047	26.0	62.0	5.20
R0235.3	5.30	0.2087	26.0	62.0	5.30
R0235.4	5.40	0.2126	28.0	66.0	5.40
R0235.5	5.50	0.2165	28.0	66.0	5.50
R0235.6	5.60	0.2205	28.0	66.0	5.60
R0235.7	5.70	0.2244	28.0	66.0	5.70
R0235.8	5.80	0.2283	28.0	66.0	5.80
R0235.9	5.90	0.2323	28.0	66.0	5.90
R0236.0	6.00	0.2362	28.0	66.0	6.00
R0236.1	6.10	0.2402	31.0	70.0	6.10
R0236.2	6.20	0.2441	31.0	70.0	6.20
R0236.3	6.30	0.2480	31.0	70.0	6.30
R0236.4	6.40	0.2520	31.0	70.0	6.40
R0236.5	6.50	0.2559	31.0	70.0	6.50



Product	DC	DC	LCF	OAL	DCON MS
	(mm)	(inch)	(mm)	(mm)	(mm)
R0236.6	6.60	0.2598	31.0	70.0	6.60
R0236.7	6.70	0.2638	31.0	70.0	6.70
R0236.8	6.80	0.2677	34.0	74.0	6.80
R0236.9	6.90	0.2717	34.0	74.0	6.90
R0237.0	7.00	0.2756	34.0	74.0	7.00
R0237.1	7.10	0.2795	34.0	74.0	7.10
R0237.2	7.20	0.2835	34.0	74.0	7.20
R0237.3	7.30	0.2874	34.0	74.0	7.30
R0237.4	7.40	0.2913	34.0	74.0	7.40
R0237.5	7.50	0.2953	34.0	74.0	7.50
R0237.6	7.60	0.2992	37.0	79.0	7.60
R0237.7	7.70	0.3031	37.0	79.0	7.70
R0237.8	7.80	0.3071	37.0	79.0	7.80
R0237.9	7.90	0.3110	37.0	79.0	7.90
R0238.0	8.00	0.3150	37.0	79.0	8.00
R0238.1	8.10	0.3189	37.0	79.0	8.10
R0238.2	8.20	0.3228	37.0	79.0	8.20
R0238.3	8.30	0.3268	37.0	79.0	8.30
R0238.4	8.40	0.3307	37.0	79.0	8.40
R0238.5	8.50	0.3346	37.0	79.0	8.50

Product	DC	DC	LCF	OAL	DCON MS
	(mm)	(inch)	(mm)	(mm)	(mm)
R0238.6	8.60	0.3386	40.0	84.0	8.60
R0238.7	8.70	0.3425	40.0	84.0	8.70
R0238.8	8.80	0.3465	40.0	84.0	8.80
R0238.9	8.90	0.3504	40.0	84.0	8.90
R0239.0	9.00	0.3543	40.0	84.0	9.00
R0239.1	9.10	0.3583	40.0	84.0	9.10
R0239.2	9.20	0.3622	40.0	84.0	9.20
R0239.3	9.30	0.3661	40.0	84.0	9.30
R0239.4	9.40	0.3701	40.0	84.0	9.40
R0239.5	9.50	0.3740	40.0	84.0	9.50
R0239.6	9.60	0.3780	43.0	89.0	9.60
R0239.7	9.70	0.3819	43.0	89.0	9.70
R0239.8	9.80	0.3858	43.0	89.0	9.80
R0239.9	9.90	0.3898	43.0	89.0	9.90
R02310.0	10.00	0.3937	43.0	89.0	10.00
R02310.2	10.20	0.4016	43.0	89.0	10.20
R02310.5	10.50	0.4134	43.0	89.0	10.50
R02311.0	11.00	0.4331	47.0	95.0	11.00
R02311.5	11.50	0.4528	47.0	95.0	11.50
R02312.0	12.00	0.4724	51.0	102.0	12.00

Código de Material (BMC)	HSS-E	HSS-E	HSS	HSS-E	HM
Grupo básico estándar (BSG)	DIN 338	DIN 338	DIN 338	DORMER DIN 338	DIN 338
Longitud Útil (ULDR)	4xD	4xD	4xD	5xD	4xD
Ángulo de aplicación	135°	130°	130°	130°	120°
Recubrimiento	Bronze	Bright	TiN	TiAlN Top	TiN-Tip
Mango				DIN 6335HA	
Forma de la Hélice	λ.20-35°	VA	λ.32-40°	λ.>35°	λ.20-35°
Mano (dirección de corte)	R	R	R	R	R
Refrigeración (CSP)					
			ADX	ADX	NEW

Código de Familia de Producto	A777	A147	A510	A553	R003
Gama de diámetros de corte PSF	0.30 - 16.00	0.30 - 15.0	3.00 - 14.00	5.00 - 18.00	1.00 - 14.00
	116	118	120	122	123

P	P1	■	■	■	■	■
	P2	■	■	■	■	■
	P3	■	■	■	■	■
	P4	■	■	■	■	■
M	M1	■	■	■	■	■
	M2	■	■	■	■	■
	M3	■	■	■	■	■
	M4	■	■	■	■	■
K	K1	■	■	■	■	■
	K2	■	■	■	■	■
	K3	■	■	■	■	■
	K4	■	■	■	■	■
	K5	■	■	■	■	■
N	N1	■	■	■	■	■
	N2	■	■	■	■	■
	N3	■	■	■	■	■
	N4	■	■	■	■	■
	N5	■	■	■	■	■
S	S1	■	■	■	■	■
	S2	■	■	■	■	■
	S3	■	■	■	■	■
	S4	■	■	■	■	■
H	H1	■	■	■	■	■
	H2	■	■	■	■	■
	H3	■	■	■	■	■
	H4	■	■	■	■	■

A777



Broca HSS-E (8% Cobalto), Serie Corta, Acabado Bronce Templado

Broca de rendimiento superior, que produce agujeros de tamaño preciso con un acabado de calidad en materiales de alta resistencia. Punta dividida a 135° para facilitar el autocentrado. El acabado bronce consiste en una fina capa de óxido y es indicativo de broca de HSS-E con 8% de cobalto.

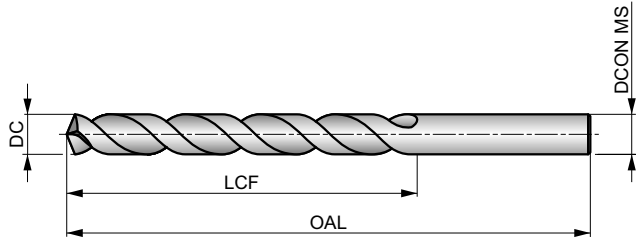

HSS-E	DIN 338	4×D
135°	Bronze	
λ 20-35°	R	DC h8

Grupo de Material de la pieza adecuado y condiciones de velocidad de corte iniciales (m/min) y código de avance alfabético. Tablas con avance por revolución a partir de la pag.274.

P1.1 ▣36 H	P1.2 ▣40 H	P1.3 ▣41 H	P2.1 ▣31 H	P2.2 ▣27 G	P2.3 ▣24 E	P3.1 ▣25 F	P3.2 ▣20 F	P3.3 ▣17 E	P4.1 ▣15 F	P4.2 ▣13 E	P4.3 ▣10 D	M1.1 ▣30 E	M1.2 ▣26 E
M2.1 ▣27 E	M2.2 ▣22 E	M3.1 ▣13 G	M3.2 ▣11 G	M3.3 ▣10 G	M4.1 ▣15 C	K1.1 ▣35 H	K1.2 ▣26 D	K1.3 ▣19 D	K2.1 ▣27 E	K2.2 ▣22 E	K2.3 ▣18 E	K3.1 ▣24 E	K3.2 ▣18 E
K3.3 ▣15 E	K4.1 ▣22 E	K4.2 ▣17 E	K4.3 ▣12 E	K4.4 ▣11 E	K4.5 ▣9 E	K5.1 ▣25 E	K5.2 ▣19 E	K5.3 ▣15 E	N1.1 ▣33 J	N1.2 ▣25 J	N1.3 ▣17 I	N2.1 ▣46 H	N2.2 ▣42 H
N2.3 ▣30 H	N3.1 ▣68 H	N3.2 ▣40 F	N3.3 ▣20 H	S1.1 ▣28 F	S1.2 ▣20 D	S1.3 ▣11 C	S2.1 ▣9 E	S2.2 ▣8 B	S3.1 ▣7 E	S3.2 ▣6 B	S4.1 ▣5 E	S4.2 ▣5 B	

NAS907J. DC ≤ 1.4mm Punta de 4 caras

Los productos de esta serie también están disponibles en forma de Set. Por favor, vea A295.

Product	DC (inch)	DC (mm)	DC (inch)	LCF (mm)	OAL (mm)	DCON MS (mm)
A777.3	—	0.30	0.0118	3.0	19.0	0.30
A777.35	—	0.35	0.0138	4.0	19.0	0.35
A777.4	—	0.40	0.0157	5.0	20.0	0.40
A777.45	—	0.45	0.0177	5.0	20.0	0.45
A777.5	—	0.50	0.0197	6.0	22.0	0.50
A777.55	—	0.55	0.0217	7.0	24.0	0.55
A777.6	—	0.60	0.0236	7.0	24.0	0.60
A777.65	—	0.65	0.0256	8.0	26.0	0.65
A777.7	—	0.70	0.0276	9.0	28.0	0.70
A777.8	—	0.80	0.0315	10.0	30.0	0.80
A777.9	—	0.90	0.0354	11.0	32.0	0.90
A777.95	—	0.95	0.0374	11.0	32.0	0.95
A7771.0	—	1.00	0.0394	12.0	34.0	1.00
A7771.1	—	1.10	0.0433	14.0	36.0	1.10
A7771.2	—	1.20	0.0472	16.0	38.0	1.20
A7771.3	—	1.30	0.0512	16.0	38.0	1.30
A7771.4	—	1.40	0.0551	18.0	40.0	1.40
A7771.5	—	1.50	0.0591	18.0	40.0	1.50
A7771/16	1/16	1.59	0.0625	20.0	43.0	1.59
A7771.6	—	1.60	0.0630	20.0	43.0	1.60
A7771.7	—	1.70	0.0669	20.0	43.0	1.70
A7771.8	—	1.80	0.0709	22.0	46.0	1.80
A7771.9	—	1.90	0.0748	22.0	46.0	1.90
A7775/64	5/64	1.98	0.0781	24.0	49.0	1.98

Product	DC (inch)	DC (mm)	DC (inch)	LCF (mm)	OAL (mm)	DCON MS (mm)
A7772.0	—	2.00	0.0787	24.0	49.0	2.00
A7772.1	—	2.10	0.0827	24.0	49.0	2.10
A7772.2	—	2.20	0.0866	27.0	53.0	2.20
A7772.3	—	2.30	0.0906	27.0	53.0	2.30
A7773/32	3/32	2.38	0.0938	30.0	57.0	2.38
A7772.4	—	2.40	0.0945	30.0	57.0	2.40
A7772.5	—	2.50	0.0984	30.0	57.0	2.50
A7772.6	—	2.60	0.1024	30.0	57.0	2.60
A7772.7	—	2.70	0.1063	33.0	61.0	2.70
A7777/64	7/64	2.78	0.1094	33.0	61.0	2.78
A7772.8	—	2.80	0.1102	33.0	61.0	2.80
A7772.9	—	2.90	0.1142	33.0	61.0	2.90
A7773.0	—	3.00	0.1181	33.0	61.0	3.00
A7773.1	—	3.10	0.1220	36.0	65.0	3.10
A7771/8	1/8	3.18	0.1250	36.0	65.0	3.18
A7773.2	—	3.20	0.1260	36.0	65.0	3.20
A7773.3	—	3.30	0.1299	36.0	65.0	3.30
A7773.4	—	3.40	0.1339	39.0	70.0	3.40
A7773.5	—	3.50	0.1378	39.0	70.0	3.50
A7779/64	9/64	3.57	0.1406	39.0	70.0	3.57
A7773.6	—	3.60	0.1417	39.0	70.0	3.60
A7773.7	—	3.70	0.1457	39.0	70.0	3.70
A7773.8	—	3.80	0.1496	43.0	75.0	3.80
A7773.9	—	3.90	0.1535	43.0	75.0	3.90



Product	DC	DC	DC	LCF	OAL	DCON MS
	(inch)	(mm)	(inch)	(mm)	(mm)	(mm)
A7775/32	5/32	3.97	0.1563	43.0	75.0	3.97
A7774.0	–	4.00	0.1575	43.0	75.0	4.00
A7774.1	–	4.10	0.1614	43.0	75.0	4.10
A7774.2	–	4.20	0.1654	43.0	75.0	4.20
A7774.3	–	4.30	0.1693	47.0	80.0	4.30
A77711/64	11/64	4.37	0.1719	47.0	80.0	4.37
A7774.4	–	4.40	0.1732	47.0	80.0	4.40
A7774.5	–	4.50	0.1772	47.0	80.0	4.50
A7774.6	–	4.60	0.1811	47.0	80.0	4.60
A7774.7	–	4.70	0.1850	47.0	80.0	4.70
A7773/16	3/16	4.76	0.1875	52.0	86.0	4.76
A7774.8	–	4.80	0.1890	52.0	86.0	4.80
A7774.9	–	4.90	0.1929	52.0	86.0	4.90
A7775.0	–	5.00	0.1969	52.0	86.0	5.00
A7775.1	–	5.10	0.2008	52.0	86.0	5.10
A77713/64	13/64	5.16	0.2031	52.0	86.0	5.16
A7775.2	–	5.20	0.2047	52.0	86.0	5.20
A7775.3	–	5.30	0.2087	52.0	86.0	5.30
A7775.4	–	5.40	0.2126	57.0	93.0	5.40
A7775.5	–	5.50	0.2165	57.0	93.0	5.50
A7777/32	7/32	5.56	0.2188	57.0	93.0	5.56
A7775.6	–	5.60	0.2205	57.0	93.0	5.60
A7775.7	–	5.70	0.2244	57.0	93.0	5.70
A7775.8	–	5.80	0.2283	57.0	93.0	5.80
A7775.9	–	5.90	0.2323	57.0	93.0	5.90
A77715/64	15/64	5.95	0.2344	57.0	93.0	5.95
A7776.0	–	6.00	0.2362	57.0	93.0	6.00
A7776.1	–	6.10	0.2402	63.0	101.0	6.10
A7776.2	–	6.20	0.2441	63.0	101.0	6.20
A7776.3	–	6.30	0.2480	63.0	101.0	6.30
A7771/4	1/4	6.35	0.2500	63.0	101.0	6.35
A7776.4	–	6.40	0.2520	63.0	101.0	6.40
A7776.5	–	6.50	0.2559	63.0	101.0	6.50
A7776.6	–	6.60	0.2598	63.0	101.0	6.60
A7776.7	–	6.70	0.2638	63.0	101.0	6.70
A77717/64	17/64	6.75	0.2656	69.0	109.0	6.75
A7776.8	–	6.80	0.2677	69.0	109.0	6.80
A7776.9	–	6.90	0.2717	69.0	109.0	6.90
A7777.0	–	7.00	0.2756	69.0	109.0	7.00
A7777.1	–	7.10	0.2795	69.0	109.0	7.10
A7779/32	9/32	7.14	0.2813	69.0	109.0	7.14
A7777.2	–	7.20	0.2835	69.0	109.0	7.20
A7777.3	–	7.30	0.2874	69.0	109.0	7.30
A7777.4	–	7.40	0.2913	69.0	109.0	7.40
A7777.5	–	7.50	0.2953	69.0	109.0	7.50
A77719/64	19/64	7.54	0.2969	75.0	117.0	7.54
A7777.6	–	7.60	0.2992	75.0	117.0	7.60
A7777.7	–	7.70	0.3031	75.0	117.0	7.70
A7777.8	–	7.80	0.3071	75.0	117.0	7.80
A7777.9	–	7.90	0.3110	75.0	117.0	7.90
A7775/16	5/16	7.94	0.3125	75.0	117.0	7.94
A7778.0	–	8.00	0.3150	75.0	117.0	8.00

Product	DC	DC	DC	LCF	OAL	DCON MS
	(inch)	(mm)	(inch)	(mm)	(mm)	(mm)
A7778.1	–	8.10	0.3189	75.0	117.0	8.10
A7778.2	–	8.20	0.3228	75.0	117.0	8.20
A7778.3	–	8.30	0.3268	75.0	117.0	8.30
A77721/64	21/64	8.33	0.3281	75.0	117.0	8.33
A7778.4	–	8.40	0.3307	75.0	117.0	8.40
A7778.5	–	8.50	0.3346	75.0	117.0	8.50
A7778.6	–	8.60	0.3386	81.0	125.0	8.60
A7778.7	–	8.70	0.3425	81.0	125.0	8.70
A77711/32	11/32	8.73	0.3438	81.0	125.0	8.73
A7778.8	–	8.80	0.3465	81.0	125.0	8.80
A7778.9	–	8.90	0.3504	81.0	125.0	8.90
A7779.0	–	9.00	0.3543	81.0	125.0	9.00
A7779.1	–	9.10	0.3583	81.0	125.0	9.10
A77723/64	23/64	9.13	0.3594	81.0	125.0	9.13
A7779.2	–	9.20	0.3622	81.0	125.0	9.20
A7779.3	–	9.30	0.3661	81.0	125.0	9.30
A7779.4	–	9.40	0.3701	81.0	125.0	9.40
A7779.5	–	9.50	0.3740	81.0	125.0	9.50
A7773/8	3/8	9.52	0.3750	87.0	133.0	9.52
A7779.6	–	9.60	0.3780	87.0	133.0	9.60
A7779.7	–	9.70	0.3819	87.0	133.0	9.70
A7779.8	–	9.80	0.3858	87.0	133.0	9.80
A7779.9	–	9.90	0.3898	87.0	133.0	9.90
A77725/64	25/64	9.92	0.3906	87.0	133.0	9.92
A77710.0	–	10.00	0.3937	87.0	133.0	10.00
A77710.1	–	10.10	0.3976	87.0	133.0	10.10
A77710.2	–	10.20	0.4016	87.0	133.0	10.20
A77713/32	13/32	10.32	0.4063	87.0	133.0	10.32
A77710.5	–	10.50	0.4134	87.0	133.0	10.50
A77727/64	27/64	10.72	0.4219	94.0	142.0	10.72
A77710.8	–	10.80	0.4252	94.0	142.0	10.80
A77711.0	–	11.00	0.4331	94.0	142.0	11.00
A7777/16	7/16	11.11	0.4375	94.0	142.0	11.11
A77711.2	–	11.20	0.4409	94.0	142.0	11.20
A77711.5	–	11.50	0.4528	94.0	142.0	11.50
A77729/64	29/64	11.51	0.4531	94.0	142.0	11.51
A77711.8	–	11.80	0.4646	94.0	142.0	11.80
A77715/32	15/32	11.91	0.4688	101.0	151.0	11.91
A77712.0	–	12.00	0.4724	101.0	151.0	12.00
A77712.2	–	12.20	0.4803	101.0	151.0	12.20
A77731/64	31/64	12.30	0.4844	101.0	151.0	12.30
A77712.5	–	12.50	0.4921	101.0	151.0	12.50
A7771/2	1/2	12.70	0.5000	101.0	151.0	12.70
A77712.8	–	12.80	0.5039	101.0	151.0	12.80
A77713.0	–	13.00	0.5118	101.0	151.0	13.00
A77713.5	–	13.50	0.5315	108.0	160.0	13.50
A77714.0	–	14.00	0.5512	108.0	160.0	14.00
A77714.5	–	14.50	0.5709	114.0	169.0	14.50
A77715.0	–	15.00	0.5906	114.0	169.0	15.00
A77715.5	–	15.50	0.6102	120.0	178.0	15.50
A77716.0	–	16.00	0.6299	120.0	178.0	16.00

A147



Broca HSS-E (5% Cobalto), Serie Corta, Acabado Brillante (Diseñada Para Acero Inoxidable)

Broca versátil y resistente que satisface todos los requisitos de taladrado en máquina en aceros inoxidable, aunque también se puede utilizar para operaciones manuales. La punta dividida a 130° mejora el auto-centrado y reduce las fuerzas de corte. Acabado brillante.

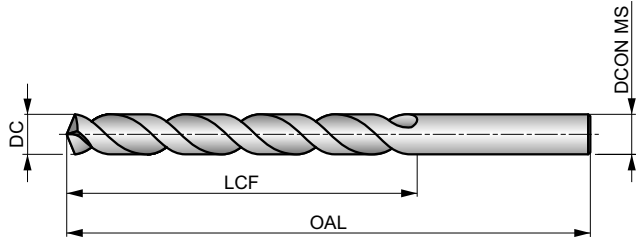

HSS-E	DIN 338	4×D
130°	Bright	
VA	R	DC h8

Grupo de Material de la pieza adecuado y condiciones de velocidad de corte iniciales (m/min) y código de avance alfabético. Tablas con avance por revolución a partir de la pag.274.

P1.1 ▣33 I	P1.2 ▣37 I	P1.3 ▣38 I	P2.1 ▣28 I	P2.2 ▣25 G	P2.3 ▣22 E	P3.1 ▣19 F	P3.2 ▣15 F	P3.3 ▣13 E	P4.1 ▣11 F	P4.2 ▣10 E	P4.3 ▣8 D	M1.1 ▣21 E	M1.2 ▣17 E
M2.1 ▣18 E	M2.2 ▣15 E	M2.3 ▣13 B	M3.1 ▣10 G	M3.2 ▣9 G	M3.3 ▣8 G	M4.1 ▣10 D	M4.2 ▣9 B	K1.1 ▣30 H	K1.2 ▣22 F	K1.3 ▣17 F	K2.1 ▣25 E	K2.2 ▣20 E	K2.3 ▣16 E
K3.1 ▣22 E	K3.2 ▣17 E	K3.3 ▣13 E	K4.1 ▣20 E	K4.2 ▣15 E	K4.3 ▣11 E	K4.4 ▣10 E	K4.5 ▣8 E	K5.1 ▣23 E	K5.2 ▣17 E	K5.3 ▣13 E	N1.1 ▣33 J	N1.2 ▣25 J	N1.3 ▣17 I
N2.1 ▣42 H	N2.2 ▣37 H	N2.3 ▣27 H	N3.1 ▣59 H	N3.2 ▣35 I	N3.3 ▣18 G	N4.1 ▣30 J	N4.2 ▣28 H	N4.3 ▣14 F	S1.1 ▣25 G	S1.2 ▣16 E	S1.3 ▣7 B	S2.1 ▣9 G	S2.2 ▣8 E
S3.1 ▣7 G	S3.2 ▣6 E	S4.1 ▣5 G	S4.2 ▣5 E										

Product	DC (inch)	DC (mm)	DC (inch)	LCF (mm)	OAL (mm)	DCON MS (mm)
A147.3	–	0.30	0.0118	3.0	19.0	0.30
A147.4	–	0.40	0.0157	5.0	20.0	0.40
A147.5	–	0.50	0.0197	6.0	22.0	0.50
A147.6	–	0.60	0.0236	7.0	24.0	0.60
A147.7	–	0.70	0.0276	9.0	28.0	0.70
A147.8	–	0.80	0.0315	10.0	30.0	0.80
A147.9	–	0.90	0.0354	11.0	32.0	0.90
A1471.0	–	1.00	0.0394	12.0	34.0	1.00
A1471.1	–	1.10	0.0433	14.0	36.0	1.10
A1471.2	–	1.20	0.0472	16.0	38.0	1.20
A1471.3	–	1.30	0.0512	16.0	38.0	1.30
A1471.4	–	1.40	0.0551	18.0	40.0	1.40
A1471.5	–	1.50	0.0591	18.0	40.0	1.50
A1471/16	1/16	1.59	0.0625	20.0	43.0	1.59
A1471.6	–	1.60	0.0630	20.0	43.0	1.60
A1471.7	–	1.70	0.0669	20.0	43.0	1.70
A1471.8	–	1.80	0.0709	22.0	46.0	1.80
A1471.9	–	1.90	0.0748	22.0	46.0	1.90
A1472.0	–	2.00	0.0787	24.0	49.0	2.00
A1472.1	–	2.10	0.0827	24.0	49.0	2.10
A1472.2	–	2.20	0.0866	27.0	53.0	2.20
A1472.3	–	2.30	0.0906	27.0	53.0	2.30
A1473/32	3/32	2.38	0.0938	30.0	57.0	2.38
A1472.4	–	2.40	0.0945	30.0	57.0	2.40

Product	DC (inch)	DC (mm)	DC (inch)	LCF (mm)	OAL (mm)	DCON MS (mm)
A1472.5	–	2.50	0.0984	30.0	57.0	2.50
A1472.6	–	2.60	0.1024	30.0	57.0	2.60
A1472.7	–	2.70	0.1063	33.0	61.0	2.70
A1472.8	–	2.80	0.1102	33.0	61.0	2.80
A1472.9	–	2.90	0.1142	33.0	61.0	2.90
A1473.0	–	3.00	0.1181	33.0	61.0	3.00
A1473.1	–	3.10	0.1220	36.0	65.0	3.10
A1471/8	1/8	3.18	0.1250	36.0	65.0	3.18
A1473.2	–	3.20	0.1260	36.0	65.0	3.20
A1473.3	–	3.30	0.1299	36.0	65.0	3.30
A1473.4	–	3.40	0.1339	39.0	70.0	3.40
A1473.5	–	3.50	0.1378	39.0	70.0	3.50
A1473.6	–	3.60	0.1417	39.0	70.0	3.60
A1473.7	–	3.70	0.1457	39.0	70.0	3.70
A1473.8	–	3.80	0.1496	43.0	75.0	3.80
A1473.9	–	3.90	0.1535	43.0	75.0	3.90
A1475/32	5/32	3.97	0.1563	43.0	75.0	3.97
A1474.0	–	4.00	0.1575	43.0	75.0	4.00
A1474.1	–	4.10	0.1614	43.0	75.0	4.10
A1474.2	–	4.20	0.1654	43.0	75.0	4.20
A1474.3	–	4.30	0.1693	47.0	80.0	4.30
A1474.4	–	4.40	0.1732	47.0	80.0	4.40
A1474.5	–	4.50	0.1772	47.0	80.0	4.50
A1474.6	–	4.60	0.1811	47.0	80.0	4.60



Product	DC	DC	DC	LCF	OAL	DCON MS
	(inch)	(mm)	(inch)	(mm)	(mm)	(mm)
A1474.7	–	4.70	0.1850	47.0	80.0	4.70
A1473/16	3/16	4.76	0.1875	52.0	86.0	4.76
A1474.8	–	4.80	0.1890	52.0	86.0	4.80
A1474.9	–	4.90	0.1929	52.0	86.0	4.90
A1475.0	–	5.00	0.1969	52.0	86.0	5.00
A1475.1	–	5.10	0.2008	52.0	86.0	5.10
A1475.2	–	5.20	0.2047	52.0	86.0	5.20
A1475.3	–	5.30	0.2087	52.0	86.0	5.30
A1475.4	–	5.40	0.2126	57.0	93.0	5.40
A1475.5	–	5.50	0.2165	57.0	93.0	5.50
A1475.6	–	5.60	0.2205	57.0	93.0	5.60
A1475.7	–	5.70	0.2244	57.0	93.0	5.70
A1475.8	–	5.80	0.2283	57.0	93.0	5.80
A1475.9	–	5.90	0.2323	57.0	93.0	5.90
A1476.0	–	6.00	0.2362	57.0	93.0	6.00
A1476.1	–	6.10	0.2402	63.0	101.0	6.10
A1476.2	–	6.20	0.2441	63.0	101.0	6.20
A1476.3	–	6.30	0.2480	63.0	101.0	6.30
A1471/4	1/4	6.35	0.2500	63.0	101.0	6.35
A1476.4	–	6.40	0.2520	63.0	101.0	6.40
A1476.5	–	6.50	0.2559	63.0	101.0	6.50
A1476.6	–	6.60	0.2598	63.0	101.0	6.60
A1476.7	–	6.70	0.2638	63.0	101.0	6.70
A1476.8	–	6.80	0.2677	69.0	109.0	6.80
A1476.9	–	6.90	0.2717	69.0	109.0	6.90
A1477.0	–	7.00	0.2756	69.0	109.0	7.00
A1477.1	–	7.10	0.2795	69.0	109.0	7.10
A1477.2	–	7.20	0.2835	69.0	109.0	7.20
A1477.3	–	7.30	0.2874	69.0	109.0	7.30
A1477.4	–	7.40	0.2913	69.0	109.0	7.40
A1477.5	–	7.50	0.2953	69.0	109.0	7.50

Product	DC	DC	DC	LCF	OAL	DCON MS
	(inch)	(mm)	(inch)	(mm)	(mm)	(mm)
A1477.7	–	7.70	0.3031	75.0	117.0	7.70
A1477.8	–	7.80	0.3071	75.0	117.0	7.80
A1477.9	–	7.90	0.3110	75.0	117.0	7.90
A1478.0	–	8.00	0.3150	75.0	117.0	8.00
A1478.1	–	8.10	0.3189	75.0	117.0	8.10
A1478.2	–	8.20	0.3228	75.0	117.0	8.20
A1478.3	–	8.30	0.3268	75.0	117.0	8.30
A1478.4	–	8.40	0.3307	75.0	117.0	8.40
A1478.5	–	8.50	0.3346	75.0	117.0	8.50
A1478.6	–	8.60	0.3386	81.0	125.0	8.60
A1478.7	–	8.70	0.3425	81.0	125.0	8.70
A1478.8	–	8.80	0.3465	81.0	125.0	8.80
A1478.9	–	8.90	0.3504	81.0	125.0	8.90
A1479.0	–	9.00	0.3543	81.0	125.0	9.00
A1479.1	–	9.10	0.3583	81.0	125.0	9.10
A1479.2	–	9.20	0.3622	81.0	125.0	9.20
A1479.5	–	9.50	0.3740	81.0	125.0	9.50
A1479.7	–	9.70	0.3819	87.0	133.0	9.70
A1479.8	–	9.80	0.3858	87.0	133.0	9.80
A14710.0	–	10.00	0.3937	87.0	133.0	10.00
A14710.2	–	10.20	0.4016	87.0	133.0	10.20
A14710.5	–	10.50	0.4134	87.0	133.0	10.50
A14711.0	–	11.00	0.4331	94.0	142.0	11.00
A14711.5	–	11.50	0.4528	94.0	142.0	11.50
A14712.0	–	12.00	0.4724	101.0	151.0	12.00
A14712.5	–	12.50	0.4921	101.0	151.0	12.50
A14713.0	–	13.00	0.5118	101.0	151.0	13.00
A14713.5	–	13.50	0.5315	108.0	160.0	13.50
A14714.0	–	14.00	0.5512	108.0	160.0	14.00
A14715.0	–	15.00	0.5906	114.0	169.0	15.00

A510



Broca ADX HSS, Serie Corta, con Recubrimiento TiN

Broca de alto rendimiento, capaz de producir agujeros precisos y de alta calidad a altas velocidades y avances (tolerancia de agujero H9). La punta adelgazada a 130 ° mejora el autocentrado. Esta broca se debe utilizar únicamente en máquinas con avance constante. El recubrimiento TiN mejora el rendimiento y prolonga la vida de la herramienta. Apta para taladrar la mayoría de materiales.



ADX

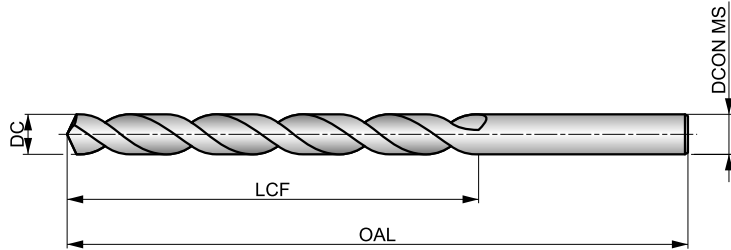

HSS	DIN 338	4×D
130°	TiN	
λ 32-40°	R	DC h8

Grupo de Material de la pieza adecuado y condiciones de velocidad de corte iniciales (m/min) y código de avance alfabético. Tablas con avance por revolución a partir de la pag.274.

P1.1 ■ 53 M	P1.2 ■ 59 M	P1.3 ■ 61 M	P2.1 ■ 45 M	P2.2 ■ 40 K	P2.3 ■ 35 F	P3.1 ■ 31 H	P3.2 ■ 25 H	P3.3 ■ 21 F	P4.1 ■ 19 H	P4.2 ■ 16 F	P4.3 ■ 13 D	M1.1 ■ 38 G	M1.2 ■ 32 G
M2.1 ■ 34 G	M2.2 ■ 28 G	M3.1 ■ 16 I	M3.2 ■ 14 I	M3.3 ■ 13 I	M4.1 ■ 19 G	K1.1 ■ 42 K	K1.2 ■ 31 J	K1.3 ■ 23 J	K2.1 ■ 34 J	K2.2 ■ 28 J	K2.3 ■ 22 F	K3.1 ■ 30 J	K3.2 ■ 23 J
K3.3 ■ 19 F	K4.1 ■ 28 J	K4.2 ■ 21 J	K4.3 ■ 16 F	K4.4 ■ 13 F	K4.5 ■ 11 F	K5.1 ■ 32 J	K5.2 ■ 24 J	K5.3 ■ 19 F	N1.1 ■ 50 G	N1.2 ■ 38 G	N1.3 ■ 25 M	N2.1 ■ 48 I	N2.2 ■ 43 I
N2.3 ■ 31 I	N3.1 ■ 85 I	N3.2 ■ 50 I	N3.3 ■ 25 D	N4.1 ■ 65 G	N4.2 ■ 50 G	S1.1 ■ 32 G	S1.2 ■ 20 H	S1.3 ■ 4 B	S2.1 ■ 12 E	S2.2 ■ 8 E	S3.1 ■ 9 E	S3.2 ■ 6 E	
S4.1 ■ 7 E	S4.2 ■ 5 E												

Product	DC (inch)	DC (mm)	DC (inch)	LCF (mm)	OAL (mm)	DCON MS (mm)
A5103.0	–	3.00	0.1181	33.0	61.0	3.00
A5103.1	–	3.10	0.1220	36.0	65.0	3.10
A5101/8	1/8	3.18	0.1250	36.0	65.0	3.18
A5103.2	–	3.20	0.1260	36.0	65.0	3.20
A5103.3	–	3.30	0.1299	36.0	65.0	3.30
A5103.4	–	3.40	0.1339	39.0	70.0	3.40
A5103.5	–	3.50	0.1378	39.0	70.0	3.50
A5109/64	9/64	3.57	0.1406	39.0	70.0	3.57
A5103.6	–	3.60	0.1417	39.0	70.0	3.60
A5103.7	–	3.70	0.1457	39.0	70.0	3.70
A5103.8	–	3.80	0.1496	43.0	75.0	3.80
A5103.9	–	3.90	0.1535	43.0	75.0	3.90
A5105/32	5/32	3.97	0.1563	43.0	75.0	3.97
A5104.0	–	4.00	0.1575	43.0	75.0	4.00
A5104.1	–	4.10	0.1614	43.0	75.0	4.10
A5104.2	–	4.20	0.1654	43.0	75.0	4.20
A5104.3	–	4.30	0.1693	47.0	80.0	4.30
A5104.4	–	4.40	0.1732	47.0	80.0	4.40
A5104.5	–	4.50	0.1772	47.0	80.0	4.50
A5104.6	–	4.60	0.1811	47.0	80.0	4.60
A5104.7	–	4.70	0.1850	47.0	80.0	4.70
A5103/16	3/16	4.76	0.1875	52.0	86.0	4.76
A5104.8	–	4.80	0.1890	52.0	86.0	4.80
A5104.9	–	4.90	0.1929	52.0	86.0	4.90

Product	DC (inch)	DC (mm)	DC (inch)	LCF (mm)	OAL (mm)	DCON MS (mm)
A5105.0	–	5.00	0.1969	52.0	86.0	5.00
A5105.1	–	5.10	0.2008	52.0	86.0	5.10
A51013/64	13/64	5.16	0.2031	52.0	86.0	5.16
A5105.2	–	5.20	0.2047	52.0	86.0	5.20
A5105.3	–	5.30	0.2087	52.0	86.0	5.30
A5105.4	–	5.40	0.2126	57.0	93.0	5.40
A5105.5	–	5.50	0.2165	57.0	93.0	5.50
A5107/32	7/32	5.56	0.2188	57.0	93.0	5.56
A5105.6	–	5.60	0.2205	57.0	93.0	5.60
A5105.7	–	5.70	0.2244	57.0	93.0	5.70
A5105.8	–	5.80	0.2283	57.0	93.0	5.80
A5105.9	–	5.90	0.2323	57.0	93.0	5.90
A51015/64	15/64	5.95	0.2344	57.0	93.0	5.95
A5106.0	–	6.00	0.2362	57.0	93.0	6.00
A5106.1	–	6.10	0.2402	63.0	101.0	6.10
A5106.2	–	6.20	0.2441	63.0	101.0	6.20
A5106.3	–	6.30	0.2480	63.0	101.0	6.30
A5101/4	1/4	6.35	0.2500	63.0	101.0	6.35
A5106.4	–	6.40	0.2520	63.0	101.0	6.40
A5106.5	–	6.50	0.2559	63.0	101.0	6.50
A5106.6	–	6.60	0.2598	63.0	101.0	6.60
A5106.7	–	6.70	0.2638	63.0	101.0	6.70
A51017/64	17/64	6.75	0.2656	69.0	109.0	6.75
A5106.8	–	6.80	0.2677	69.0	109.0	6.80



Product	DC	DC	DC	LCF	OAL	DCON MS
	(inch)	(mm)	(inch)	(mm)	(mm)	(mm)
A5106.9	–	6.90	0.2717	69.0	109.0	6.90
A5107.0	–	7.00	0.2756	69.0	109.0	7.00
A5107.1	–	7.10	0.2795	69.0	109.0	7.10
A5109/32	9/32	7.14	0.2813	69.0	109.0	7.14
A5107.2	–	7.20	0.2835	69.0	109.0	7.20
A5107.3	–	7.30	0.2874	69.0	109.0	7.30
A5107.4	–	7.40	0.2913	69.0	109.0	7.40
A5107.5	–	7.50	0.2953	69.0	109.0	7.50
A51019/64	19/64	7.54	0.2969	75.0	117.0	7.54
A5107.6	–	7.60	0.2992	75.0	117.0	7.60
A5107.8	–	7.80	0.3071	75.0	117.0	7.80
A5105/16	5/16	7.94	0.3125	75.0	117.0	7.94
A5108.0	–	8.00	0.3150	75.0	117.0	8.00
A5108.1	–	8.10	0.3189	75.0	117.0	8.10
A5108.2	–	8.20	0.3228	75.0	117.0	8.20
A5108.3	–	8.30	0.3268	75.0	117.0	8.30
A5108.5	–	8.50	0.3346	75.0	117.0	8.50
A5108.6	–	8.60	0.3386	81.0	125.0	8.60
A5108.7	–	8.70	0.3425	81.0	125.0	8.70
A51011/32	11/32	8.73	0.3438	81.0	125.0	8.73
A5108.8	–	8.80	0.3465	81.0	125.0	8.80
A5108.9	–	8.90	0.3504	81.0	125.0	8.90
A5109.0	–	9.00	0.3543	81.0	125.0	9.00
A5109.1	–	9.10	0.3583	81.0	125.0	9.10
A5109.2	–	9.20	0.3622	81.0	125.0	9.20
A5109.3	–	9.30	0.3661	81.0	125.0	9.30
A5109.4	–	9.40	0.3701	81.0	125.0	9.40
A5109.5	–	9.50	0.3740	81.0	125.0	9.50
A5103/8	3/8	9.52	0.3750	87.0	133.0	9.52

Product	DC	DC	DC	LCF	OAL	DCON MS
	(inch)	(mm)	(inch)	(mm)	(mm)	(mm)
A5109.6	–	9.60	0.3780	87.0	133.0	9.60
A5109.7	–	9.70	0.3819	87.0	133.0	9.70
A5109.8	–	9.80	0.3858	87.0	133.0	9.80
A5109.9	–	9.90	0.3898	87.0	133.0	9.90
A51025/64	25/64	9.92	0.3906	87.0	133.0	9.92
A51010.0	–	10.00	0.3937	87.0	133.0	10.00
A51010.1	–	10.10	0.3976	87.0	133.0	10.10
A51010.2	–	10.20	0.4016	87.0	133.0	10.20
A51010.3	–	10.30	0.4055	87.0	133.0	10.30
A51013/32	13/32	10.32	0.4063	87.0	133.0	10.32
A51010.4	–	10.40	0.4094	87.0	133.0	10.40
A51010.5	–	10.50	0.4134	87.0	133.0	10.50
A51027/64	27/64	10.72	0.4219	94.0	142.0	10.72
A51010.8	–	10.80	0.4252	94.0	142.0	10.80
A51011.0	–	11.00	0.4331	94.0	142.0	11.00
A51011.1	–	11.10	0.4370	94.0	142.0	11.10
A5107/16	7/16	11.11	0.4375	94.0	142.0	11.11
A51011.5	–	11.50	0.4528	94.0	142.0	11.50
A51011.7	–	11.70	0.4606	94.0	142.0	11.70
A51011.8	–	11.80	0.4646	94.0	142.0	11.80
A51015/32	15/32	11.91	0.4688	101.0	151.0	11.91
A51012.0	–	12.00	0.4724	101.0	151.0	12.00
A51012.3	–	12.30	0.4843	101.0	151.0	12.30
A51031/64	31/64	12.30	0.4844	101.0	151.0	12.30
A51012.5	–	12.50	0.4921	101.0	151.0	12.50
A5101/2	1/2	12.70	0.5000	101.0	151.0	12.70
A51013.0	–	13.00	0.5118	101.0	151.0	13.00
A51014.0	–	14.00	0.5512	108.0	160.0	14.00

A553



Broca ADX HSS-E (5% Cobalto), Serie Corta, con Refrigeración Interna, con Recubrimiento TiAIN Top

Broca de alto rendimiento, capaz de producir agujeros precisos y de alta calidad a altas velocidades y avances (tolerancia de agujero H9). La punta adelgazada a 130° y el recubrimiento TiAIN Top mejoran el rendimiento y prolongan la vida de la herramienta. Esta broca se debe utilizar únicamente en máquinas CNC. Apta para taladrar la mayoría de materiales.

ADX

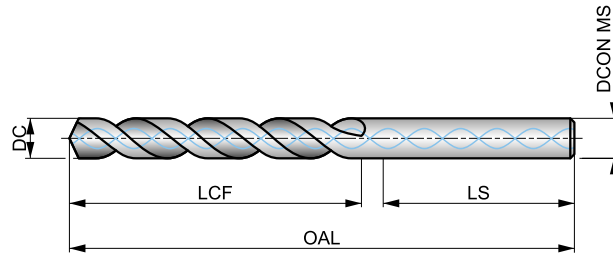

HSS-E	DORMER	5xD
130°	TiAIN Top	DIN 6535HA
>35°	R	
DC h8		

Grupo de Material de la pieza adecuado y condiciones de velocidad de corte iniciales (m/min) y código de avance alfabético. Tablas con avance por revolución a partir de la pag.274.

P1.1 ■ 80 L	P1.2 ■ 89 L	P1.3 ■ 92 L	P2.1 ■ 68 L	P2.2 ■ 60 L	P2.3 ■ 53 F	P3.1 ■ 41 H	P3.2 ■ 33 H	P3.3 ■ 28 F	P4.1 ■ 25 H	P4.2 ■ 21 F	P4.3 ■ 17 D	M1.1 ■ 55 G	M1.2 ■ 46 G
M2.1 ■ 49 G	M2.2 ■ 40 G	M3.1 ■ 22 I	M3.2 ■ 19 I	M3.3 ▣ 17 I	M4.1 ▣ 27 G	K1.1 ■ 70 K	K1.2 ■ 52 J	K1.3 ■ 39 J	K2.1 ■ 55 J	K2.2 ■ 45 J	K2.3 ■ 36 F	K3.1 ■ 49 J	K3.2 ■ 37 J
K3.3 ■ 30 F	K4.1 ■ 45 J	K4.2 ■ 34 J	K4.3 ■ 25 F	K4.4 ■ 22 F	K4.5 ■ 18 F	K5.1 ■ 51 J	K5.2 ■ 39 J	K5.3 ■ 30 F	N1.1 ▣ 70 H	N1.2 ▣ 53 H	N1.3 ■ 35 M	N2.1 ■ 85 I	N2.2 ■ 76 I
N2.3 ■ 55 I	N3.1 ■ 144 I	N3.2 ■ 85 I	N3.3 ▣ 43 G	N4.1 ■ 90 G	S1.1 ■ 45 G	S1.2 ▣ 30 E	S1.3 ▣ 8 C	S2.1 ▣ 20 E	S2.2 ▣ 14 G	S3.1 ▣ 15 E	S3.2 ▣ 10 G	S4.1 ▣ 12 E	S4.2 ▣ 8 G

DCON MS tolerancia h6.

Product	DC (mm)	DC (inch)	LCF (mm)	OAL (mm)	LS (mm)	DCON MS (mm)
A5535.0	5.00	0.1969	36.0	79.0	36.0	6.00
A5535.5	5.50	0.2165	40.0	79.0	36.0	6.00
A5536.0	6.00	0.2362	43.0	79.0	36.0	6.00
A5538.0	8.00	0.3150	58.0	94.0	36.0	8.00
A5538.5	8.50	0.3346	75.0	130.0	40.0	10.00
A5539.0	9.00	0.3543	75.0	130.0	40.0	10.00
A5539.5	9.50	0.3740	75.0	130.0	40.0	10.00
A55310.3	10.30	0.4055	87.0	150.0	45.0	12.00
A55311.0	11.00	0.4331	94.0	150.0	45.0	12.00

Product	DC (mm)	DC (inch)	LCF (mm)	OAL (mm)	LS (mm)	DCON MS (mm)
A55311.3	11.30	0.4449	94.0	150.0	45.0	12.00
A55311.5	11.50	0.4528	94.0	150.0	45.0	12.00
A55312.0	12.00	0.4724	94.0	150.0	45.0	12.00
A55312.5	12.50	0.4921	101.0	160.0	45.0	14.00
A55313.0	13.00	0.5118	101.0	160.0	45.0	14.00
A55313.5	13.50	0.5315	101.0	160.0	45.0	14.00
A55314.0	14.00	0.5512	101.0	160.0	45.0	14.00
A55315.0	15.00	0.5906	108.0	170.0	48.0	16.00
A55318.0	18.00	0.7087	130.0	190.0	48.0	18.00

R003



Broca de metal duro, punta recubierta TiN

Broca básica y versátil con ángulo de punta de 120° y geometría de punta dividida en cuatro facetas para reducir la fuerza de empuje. Tecnología CTW para mejorar la velocidad de taladrado. El recubrimiento TiN de la punta mejora el rendimiento y prolonga la vida útil de la herramienta. Adecuada para máquinas CNC y convencionales en el taladrado de una amplia gama de materiales.

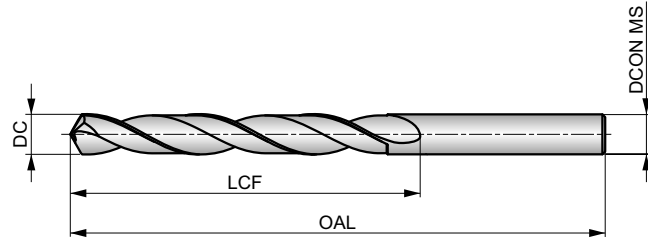

HM	DIN 338	4xD
120°	TiN-Tip	
λ 20-35°	R	DC h7

Grupo de Material de la pieza adecuado y condiciones de velocidad de corte iniciales (m/min) y código de avance alfabético. Tablas con avance por revolución a partir de la pag.274.

P1.1 ■ 99 S	P1.2 ■ 111 S	P1.3 ■ 115 S	P2.1 ■ 85 S	P2.2 ■ 75 S	P2.3 ■ 66 S	P3.1 ■ 66 S	P3.2 ■ 53 S	P3.3 ■ 45 S	P4.1 ■ 40 S	P4.2 ■ 34 S	P4.3 ■ 27 S	K1.1 ■ 75 T	K1.2 ■ 56 T
K1.3 ■ 42 T	K2.1 ■ 68 T	K2.2 ■ 55 T	K2.3 ■ 44 T	K3.1 ■ 60 T	K3.2 ■ 46 T	K3.3 ■ 37 T	K4.1 ■ 55 T	K4.2 ■ 42 T	K4.3 ■ 31 T	K4.4 ■ 26 T	K4.5 ■ 22 T	K5.1 ■ 63 T	K5.2 ■ 47 T
K5.3 ■ 37 T	N1.1 ■ 150 V	N1.2 ■ 113 V	N1.3 ■ 75 V	N2.1 ■ 129 V	N2.2 ■ 116 V	N2.3 ■ 84 V	N3.1 ■ 317 V	N3.2 ■ 190 V	N4.1 ■ 60 U	N4.2 ■ 100 U	H1.1 ■ 34 S	H2.1 ■ 20 S	H3.1 ■ 22 S

Product	DC (inch)	DC (mm)	DC (inch)	LCF (mm)	OAL (mm)	DCON MS (mm)
R0031.0	-	1.00	0.0394	12.0	34.0	1.00
R003N60	N60	1.02	0.0400	12.0	34.0	1.02
R0031.1	-	1.10	0.0433	14.0	36.0	1.10
R003N56	N56	1.18	0.0465	16.0	38.0	1.18
R0033/64	3/64	1.19	0.0469	16.0	38.0	1.19
R0031.2	-	1.20	0.0472	16.0	38.0	1.20
R0031.3	-	1.30	0.0512	16.0	38.0	1.30
R003N54	N54	1.40	0.0550	18.0	40.0	1.40
R0031.4	-	1.40	0.0551	18.0	40.0	1.40
R0031.5	-	1.50	0.0591	18.0	40.0	1.50
R003N53	N53	1.51	0.0595	20.0	43.0	1.51
R0031/16	1/16	1.59	0.0625	20.0	43.0	1.59
R0031.6	-	1.60	0.0630	20.0	43.0	1.60
R003N52	N52	1.61	0.0635	20.0	43.0	1.61
R0031.7	-	1.70	0.0669	20.0	43.0	1.70
R003N51	N51	1.70	0.0670	22.0	46.0	1.70
R003N50	N50	1.78	0.0700	22.0	46.0	1.78
R0031.8	-	1.80	0.0709	22.0	46.0	1.80
R0031.9	-	1.90	0.0748	22.0	46.0	1.90
R003N48	N48	1.93	0.0760	24.0	49.0	1.93
R0035/64	5/64	1.98	0.0781	24.0	49.0	1.98
R003N47	N47	1.99	0.0785	24.0	49.0	1.99
R0032.0	-	2.00	0.0787	24.0	49.0	2.00
R003N46	N46	2.06	0.0810	24.0	49.0	2.06
R0032.1	-	2.10	0.0827	24.0	49.0	2.10
R003N44	N44	2.18	0.0860	27.0	53.0	2.18
R0032.2	-	2.20	0.0866	27.0	53.0	2.20
R003N43	N43	2.26	0.0890	27.0	53.0	2.26

Product	DC (inch)	DC (mm)	DC (inch)	LCF (mm)	OAL (mm)	DCON MS (mm)
R0032.3	-	2.30	0.0906	27.0	53.0	2.30
R0033/32	3/32	2.38	0.0937	30.0	57.0	2.38
R0032.4	-	2.40	0.0945	30.0	57.0	2.40
R003N41	N41	2.44	0.0960	30.0	57.0	2.44
R0032.5	-	2.50	0.0984	30.0	57.0	2.50
R003N39	N39	2.53	0.0995	30.0	57.0	2.53
R003N38	N38	2.58	0.1015	30.0	57.0	2.58
R0032.6	-	2.60	0.1024	30.0	57.0	2.60
R003N37	N37	2.64	0.1040	30.0	57.0	2.64
R0032.7	-	2.70	0.1063	33.0	61.0	2.70
R003N36	N36	2.71	0.1065	33.0	61.0	2.71
R0037/64	7/64	2.78	0.1094	33.0	61.0	2.78
R0032.8	-	2.80	0.1102	33.0	61.0	2.80
R003N33	N33	2.87	0.1130	33.0	61.0	2.87
R0032.9	-	2.90	0.1142	33.0	61.0	2.90
R003N32	N32	2.95	0.1160	33.0	61.0	2.95
R0033.0	-	3.00	0.1181	33.0	61.0	3.00
R003N31	N31	3.05	0.1200	36.0	65.0	3.05
R0033.1	-	3.10	0.1220	36.0	65.0	3.10
R0031/8	1/8	3.17	0.1250	36.0	65.0	3.17
R0033.2	-	3.20	0.1260	36.0	65.0	3.20
R0033.3	-	3.30	0.1299	36.0	65.0	3.30
R0033.4	-	3.40	0.1339	39.0	70.0	3.40
R003N29	N29	3.45	0.1360	39.0	70.0	3.45
R0033.5	-	3.50	0.1378	39.0	70.0	3.50
R003N28	N28	3.57	0.1405	39.0	70.0	3.57
R0039/64	9/64	3.57	0.1406	39.0	70.0	3.57
R0033.6	-	3.60	0.1417	39.0	70.0	3.60

Product	DC	DC	DC	LCF	OAL	DCON MS
	(inch)	(mm)	(inch)	(mm)	(mm)	(mm)
R0033.7	—	3.70	0.1457	39.0	70.0	3.70
R003N26	N26	3.73	0.1470	39.0	70.0	3.73
R003N25	N25	3.80	0.1495	43.0	75.0	3.80
R0033.8	—	3.80	0.1496	43.0	75.0	3.80
R0033.9	—	3.90	0.1535	43.0	75.0	3.90
R0035/32	5/32	3.97	0.1563	43.0	75.0	3.97
R0034.0	—	4.00	0.1575	43.0	75.0	4.00
R003N21	N21	4.04	0.1590	43.0	75.0	4.04
R003N20	N20	4.09	0.1610	43.0	75.0	4.09
R0034.1	—	4.10	0.1614	43.0	75.0	4.10
R0034.2	—	4.20	0.1654	43.0	75.0	4.20
R003N19	N19	4.22	0.1660	43.0	75.0	4.22
R0034.3	—	4.30	0.1693	47.0	80.0	4.30
R00311/64	11/64	4.37	0.1719	47.0	80.0	4.37
R003N17	N17	4.39	0.1730	47.0	80.0	4.39
R0034.4	—	4.40	0.1732	47.0	80.0	4.40
R0034.5	—	4.50	0.1772	47.0	80.0	4.50
R003N15	N15	4.57	0.1800	47.0	80.0	4.57
R0034.6	—	4.60	0.1811	47.0	80.0	4.60
R0034.7	—	4.70	0.1850	47.0	80.0	4.70
R0033/16	3/16	4.76	0.1875	52.0	86.0	4.76
R003N12	N12	4.80	0.1890	52.0	86.0	4.80
R0034.8	—	4.80	0.1890	52.0	86.0	4.80
R003N11	N11	4.85	0.1910	52.0	86.0	4.85
R0034.9	—	4.90	0.1929	52.0	86.0	4.90
R003N10	N10	4.92	0.1935	52.0	86.0	4.92
R0035.0	—	5.00	0.1969	52.0	86.0	5.00
R0035.1	—	5.10	0.2008	52.0	86.0	5.10
R003N7	N7	5.11	0.2010	52.0	86.0	5.11
R00313/64	13/64	5.16	0.2031	52.0	86.0	5.16
R0035.2	—	5.20	0.2047	52.0	86.0	5.20
R0035.3	—	5.30	0.2087	52.0	86.0	5.30
R0035.4	—	5.40	0.2126	57.0	93.0	5.40
R003N3	N3	5.41	0.2130	57.0	93.0	5.41
R0035.5	—	5.50	0.2165	57.0	93.0	5.50
R0037/32	7/32	5.56	0.2187	57.0	93.0	5.56
R0035.6	—	5.60	0.2205	57.0	93.0	5.60
R003N2	N2	5.61	0.2210	57.0	93.0	5.61
R0035.7	—	5.70	0.2244	57.0	93.0	5.70
R0035.8	—	5.80	0.2283	57.0	93.0	5.80
R0035.9	—	5.90	0.2323	57.0	93.0	5.90
R00315/64	15/64	5.95	0.2344	57.0	93.0	5.95
R0036.0	—	6.00	0.2362	57.0	93.0	6.00
R0036.1	—	6.10	0.2402	63.0	101.0	6.10
R003C	C	6.15	0.2420	63.0	101.0	6.15
R0036.2	—	6.20	0.2441	63.0	101.0	6.20
R0036.3	—	6.30	0.2480	63.0	101.0	6.30
R0031/4	1/4	6.35	0.2500	63.0	101.0	6.35
R0036.4	—	6.40	0.2520	63.0	101.0	6.40
R0036.5	—	6.50	0.2559	63.0	101.0	6.50
R003F	F	6.53	0.2570	63.0	101.0	6.53
R0036.6	—	6.60	0.2598	63.0	101.0	6.60
R0036.7	—	6.70	0.2638	63.0	101.0	6.70
R00317/64	17/64	6.75	0.2656	69.0	109.0	6.75
R0036.8	—	6.80	0.2677	69.0	109.0	6.80
R0036.9	—	6.90	0.2717	69.0	109.0	6.90

Product	DC	DC	DC	LCF	OAL	DCON MS
	(inch)	(mm)	(inch)	(mm)	(mm)	(mm)
R003I	I	6.91	0.2720	69.0	109.0	6.91
R0037.0	—	7.00	0.2756	69.0	109.0	7.00
R0037.1	—	7.10	0.2795	69.0	109.0	7.10
R0039/32	9/32	7.14	0.2813	69.0	109.0	7.14
R0037.2	—	7.20	0.2835	69.0	109.0	7.20
R0037.3	—	7.30	0.2874	69.0	109.0	7.30
R0037.4	—	7.40	0.2913	69.0	109.0	7.40
R0037.5	—	7.50	0.2953	69.0	109.0	7.50
R00319/64	19/64	7.54	0.2969	75.0	117.0	7.54
R0037.6	—	7.60	0.2992	75.0	117.0	7.60
R0037.7	—	7.70	0.3031	75.0	117.0	7.70
R0037.8	—	7.80	0.3071	75.0	117.0	7.80
R0037.9	—	7.90	0.3110	75.0	117.0	7.90
R0035/16	5/16	7.94	0.3125	75.0	117.0	7.94
R0038.0	—	8.00	0.3150	75.0	117.0	8.00
R0038.1	—	8.10	0.3189	75.0	117.0	8.10
R0038.2	—	8.20	0.3228	75.0	117.0	8.20
R0038.3	—	8.30	0.3268	75.0	117.0	8.30
R00321/64	21/64	8.33	0.3281	75.0	117.0	8.33
R0038.4	—	8.40	0.3307	75.0	117.0	8.40
R003Q	Q	8.43	0.3320	75.0	117.0	8.43
R0038.5	—	8.50	0.3346	75.0	117.0	8.50
R0038.6	—	8.60	0.3386	81.0	125.0	8.60
R003R	R	8.61	0.3390	81.0	125.0	8.61
R0038.7	—	8.70	0.3425	81.0	125.0	8.70
R00311/32	11/32	8.73	0.3437	81.0	125.0	8.73
R0038.8	—	8.80	0.3465	81.0	125.0	8.80
R0038.9	—	8.90	0.3504	81.0	125.0	8.90
R0039.0	—	9.00	0.3543	81.0	125.0	9.00
R0039.1	—	9.10	0.3583	81.0	125.0	9.10
R00323/64	23/64	9.13	0.3594	81.0	125.0	9.13
R0039.2	—	9.20	0.3622	81.0	125.0	9.20
R0039.3	—	9.30	0.3661	81.0	125.0	9.30
R003U	U	9.35	0.3680	81.0	125.0	9.35
R0039.4	—	9.40	0.3701	81.0	125.0	9.40
R0039.5	—	9.50	0.3740	81.0	125.0	9.50
R0033/8	3/8	9.53	0.3750	87.0	133.0	9.53
R0039.6	—	9.60	0.3780	87.0	133.0	9.60
R0039.7	—	9.70	0.3819	87.0	133.0	9.70
R0039.8	—	9.80	0.3858	87.0	133.0	9.80
R003W	W	9.80	0.3860	87.0	133.0	9.80
R0039.9	—	9.90	0.3898	87.0	133.0	9.90
R00310.0	—	10.00	0.3937	87.0	133.0	10.00
R00310.2	—	10.20	0.4016	87.0	133.0	10.20
R00313/32	13/32	10.32	0.4063	87.0	133.0	10.32
R00310.5	—	10.50	0.4134	87.0	133.0	10.50
R00327/64	27/64	10.72	0.4219	94.0	142.0	10.72
R00311.0	—	11.00	0.4331	94.0	142.0	11.00
R0037/16	7/16	11.11	0.4375	94.0	142.0	11.11
R00311.5	—	11.50	0.4528	94.0	142.0	11.50
R00329/64	29/64	11.51	0.4531	94.0	142.0	11.51
R00315/32	15/32	11.91	0.4687	101.0	151.0	11.91
R00312.0	—	12.00	0.4724	101.0	151.0	12.00
R0031/2	1/2	12.70	0.5000	101.0	151.0	12.70
R00313.0	—	13.00	0.5118	101.0	151.0	13.00
R00314.0	—	14.00	0.5512	108.0	160.0	14.00

Código de Material (BMC)	HSS-E	HSS-E	HSS-E	HSS-E	HSS-E	HSS									
Grupo básico estándar (BSG)	DIN ANSI	DIN ANSI	DIN 1869-1	DIN 1869-2	DIN 1869-3	DIN 1870(2)									
Longitud Útil (ULDR)	6×D	10×D	15×D	20×D	25×D	20×D									
Ángulo de aplicación															
Recubrimiento	Bright	Bright	Bright	Bright	Bright	Bright ST									
Mango															
Forma de la Hélice															
Mano (dirección de corte)															
	PFX	PFX	PFX	PFX	PFX										

Código de Familia de Producto	A900	A940	A976	A977	A978	A952									
Gama de diámetros de corte PSF	1.00 - 20.00	1.00 - 19.00	1.50 - 14.00	1.50 - 14.00	3.00 - 10.00	8.00 - 30.00									
	126	128	130	131	132	133									

P	P1	■	■	▣	▣	▣	■								
	P2	■	■	■	■	■	■								
	P3	■	■	■	■	■	▣								
	P4	■	■	■	■	■	▣								
M	M1	■	■	▣	▣	▣	▣								
	M2	■	■	▣	▣	▣	▣								
	M3	■	■	▣	▣	▣	▣								
	M4	■	■	▣	▣	▣	▣								
K	K1	▣					▣								
	K2	▣	▣	▣	▣	▣	▣								
	K3	▣	▣	▣	▣	▣	▣								
	K4	▣	▣	▣	▣	▣	▣								
	K5	▣	▣	▣	▣	▣	▣								
N	N1	▣	▣				▣								
	N2	▣	▣				▣								
	N3	▣	▣	▣	▣	▣	▣								
	N4	▣	▣				▣								
	N5														
S	S1	■	■	▣	▣	▣	▣								
	S2	■					▣								
	S3	■					▣								
	S4	■					▣								
H	H1														
	H2														
	H3														
	H4														

A900



Broca PFX HSS-E (5% Cobalto), Serie Corta, Acabado Brillante

Broca de alto rendimiento, capaz de producir agujeros precisos y de alta calidad a altas velocidades y avances (tolerancia de agujero H10). La punta autocentrante a 130° y el diseño especial parabólico de los canales ayudan a taladrar agujeros profundos en una sola pasada. Apta para la mayoría de materiales.

PFX

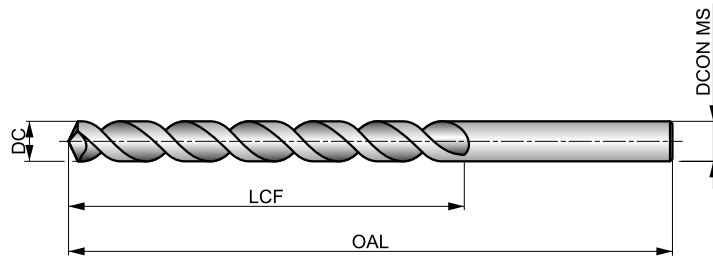

HSS-E	DIN ANSI	6×D
130°	Bright	
λ>35°		DC h8

Grupo de Material de la pieza adecuado y condiciones de velocidad de corte iniciales (m/min) y código de avance alfabético. Tablas con avance por revolución a partir de la pag.274.

P1.1 ■ 34 H	P1.2 ■ 39 H	P1.3 ■ 40 H	P2.1 ■ 30 H	P2.2 ■ 26 H	P2.3 ■ 23 E	P3.1 ■ 31 H	P3.2 ■ 25 H	P3.3 ■ 21 E	P4.1 ■ 19 H	P4.2 ■ 16 E	P4.3 ■ 13 E	M1.1 ■ 21 E	M1.2 ■ 17 E
M2.1 ■ 18 E	M2.2 ■ 15 E	M3.1 ■ 8 E	M3.2 ■ 7 E	M3.3 ■ 6 E	M4.1 ■ 9 C	K1.1 □ 24 J	K1.2 □ 18 J	K1.3 □ 13 J	K2.1 □ 23 J	K2.2 □ 19 J	K2.3 □ 15 I	K3.1 □ 21 J	K3.2 □ 16 J
K3.3 □ 13 I	K4.1 □ 19 J	K4.2 □ 14 J	K4.3 □ 11 I	K4.4 □ 9 I	K4.5 □ 8 I	K5.1 □ 22 J	K5.2 □ 16 J	K5.3 □ 13 I	N1.1 □ 60 J	N1.2 □ 45 J	N1.3 □ 30 N	N2.1 □ 62 N	N2.2 □ 55 N
N2.3 □ 40 N	N3.1 □ 90 H	N3.2 □ 53 I	N3.3 □ 27 G	N4.1 □ 55 I	N4.2 □ 40 G	S1.1 ■ 22 E	S1.2 ■ 15 E	S1.3 ■ 6 C	S2.1 ■ 9 G	S2.2 ■ 8 C	S3.1 ■ 7 G	S3.2 ■ 6 C	S4.1 ■ 5 G
S4.2 ■ 5 C													

Product	DC (inch)	DC (mm)	DC (inch)	LCF (mm)	OAL (mm)	DCON MS (mm)
A9001.0	–	1.00	0.0394	12.0	34.0	1.00
A9001.1	–	1.10	0.0433	14.0	36.0	1.10
A9001.2	–	1.20	0.0472	16.0	38.0	1.20
A9001.25	–	1.25	0.0492	16.0	36.0	1.25
A9001.3	–	1.30	0.0512	16.0	38.0	1.30
A9001.4	–	1.40	0.0551	18.0	40.0	1.40
A9001.5	–	1.50	0.0591	18.0	40.0	1.50
A9001.55	–	1.55	0.0610	20.0	43.0	1.55
A9001/16	1/16	1.59	0.0625	22.0	48.0	1.59
A9001.6	–	1.60	0.0630	20.0	43.0	1.60
A9001.7	–	1.70	0.0669	20.0	43.0	1.70
A9001.75	–	1.75	0.0689	22.0	46.0	1.75
A9001.8	–	1.80	0.0709	22.0	46.0	1.80
A9001.9	–	1.90	0.0748	22.0	46.0	1.90
A9005/64	5/64	1.98	0.0781	25.0	51.0	1.98
A9002.0	–	2.00	0.0787	24.0	49.0	2.00
A9002.1	–	2.10	0.0827	24.0	49.0	2.10
A9002.2	–	2.20	0.0866	27.0	53.0	2.20
A9002.3	–	2.30	0.0906	27.0	53.0	2.30
A9003/32	3/32	2.38	0.0937	32.0	57.0	2.38
A9002.4	–	2.40	0.0945	30.0	57.0	2.40
A9002.5	–	2.50	0.0984	30.0	57.0	2.50
A9002.6	–	2.60	0.1024	30.0	57.0	2.60
A9002.7	–	2.70	0.1063	33.0	61.0	2.70

Product	DC (inch)	DC (mm)	DC (inch)	LCF (mm)	OAL (mm)	DCON MS (mm)
A9007/64	7/64	2.78	0.1094	38.0	67.0	2.78
A9002.8	–	2.80	0.1102	33.0	61.0	2.80
A9002.9	–	2.90	0.1142	33.0	61.0	2.90
A9003.0	–	3.00	0.1181	33.0	61.0	3.00
A9003.1	–	3.10	0.1220	36.0	65.0	3.10
A9001/8	1/8	3.18	0.1250	41.0	70.0	3.18
A9003.2	–	3.20	0.1260	36.0	65.0	3.20
A9003.3	–	3.30	0.1299	36.0	65.0	3.30
A9003.4	–	3.40	0.1339	39.0	70.0	3.40
A9003.5	–	3.50	0.1378	39.0	70.0	3.50
A9009/64	9/64	3.57	0.1406	44.0	73.0	3.57
A9003.6	–	3.60	0.1417	39.0	70.0	3.60
A9003.7	–	3.70	0.1457	39.0	70.0	3.70
A9003.8	–	3.80	0.1496	43.0	75.0	3.80
A9003.9	–	3.90	0.1535	43.0	75.0	3.90
A9005/32	5/32	3.97	0.1563	51.0	79.0	3.97
A9004.0	–	4.00	0.1575	43.0	75.0	4.00
A9004.1	–	4.10	0.1614	43.0	75.0	4.10
A9004.2	–	4.20	0.1654	43.0	75.0	4.20
A9004.3	–	4.30	0.1693	47.0	80.0	4.30
A90011/64	11/64	4.37	0.1719	54.0	83.0	4.37
A9004.5	–	4.50	0.1772	47.0	80.0	4.50
A9004.6	–	4.60	0.1811	47.0	80.0	4.60
A9004.7	–	4.70	0.1850	47.0	80.0	4.70



Product	DC	DC	DC	LCF	OAL	DCON MS
	(inch)	(mm)	(inch)	(mm)	(mm)	(mm)
A9003/16	3/16	4.76	0.1875	59.0	89.0	4.76
A9004.9	–	4.90	0.1929	52.0	86.0	4.90
A9005.0	–	5.00	0.1969	52.0	86.0	5.00
A9005.1	–	5.10	0.2008	52.0	86.0	5.10
A90013/64	13/64	5.16	0.2031	62.0	92.0	5.16
A9005.2	–	5.20	0.2047	52.0	86.0	5.20
A9005.3	–	5.30	0.2087	52.0	86.0	5.30
A9005.4	–	5.40	0.2126	57.0	93.0	5.40
A9005.5	–	5.50	0.2165	57.0	93.0	5.50
A9007/32	7/32	5.56	0.2188	64.0	95.0	5.56
A9005.6	–	5.60	0.2205	57.0	93.0	5.60
A9005.7	–	5.70	0.2244	57.0	93.0	5.70
A9005.8	–	5.80	0.2283	57.0	93.0	5.80
A9005.9	–	5.90	0.2323	57.0	93.0	5.90
A9006.0	–	6.00	0.2362	57.0	93.0	6.00
A9006.1	–	6.10	0.2402	63.0	101.0	6.10
A9006.2	–	6.20	0.2441	63.0	101.0	6.20
A9006.3	–	6.30	0.2480	63.0	101.0	6.30
A9001/4	1/4	6.35	0.2500	70.0	102.0	6.35
A9006.4	–	6.40	0.2520	63.0	101.0	6.40
A9006.5	–	6.50	0.2559	63.0	101.0	6.50
A9006.6	–	6.60	0.2598	63.0	101.0	6.60
A9006.7	–	6.70	0.2638	63.0	101.0	6.70
A90017/64	17/64	6.75	0.2656	73.0	105.0	6.75
A9006.8	–	6.80	0.2677	69.0	109.0	6.80
A9006.9	–	6.90	0.2717	69.0	109.0	6.90
A9007.0	–	7.00	0.2756	69.0	109.0	7.00
A9007.1	–	7.10	0.2795	69.0	109.0	7.10
A9007.2	–	7.20	0.2835	69.0	109.0	7.20
A9007.4	–	7.40	0.2913	69.0	109.0	7.40
A9007.5	–	7.50	0.2953	69.0	109.0	7.50
A9005/16	5/16	7.94	0.3125	81.0	114.0	7.94
A9008.0	–	8.00	0.3150	75.0	117.0	8.00
A9008.1	–	8.10	0.3189	75.0	117.0	8.10
A9008.5	–	8.50	0.3346	75.0	117.0	8.50

Product	DC	DC	DC	LCF	OAL	DCON MS
	(inch)	(mm)	(inch)	(mm)	(mm)	(mm)
A9008.7	–	8.70	0.3425	81.0	125.0	8.70
A90011/32	11/32	8.73	0.3438	87.0	121.0	8.73
A9008.8	–	8.80	0.3465	81.0	125.0	8.80
A9009.0	–	9.00	0.3543	81.0	125.0	9.00
A9009.5	–	9.50	0.3740	81.0	125.0	9.50
A9003/8	3/8	9.52	0.3750	92.0	127.0	9.52
A90010.0	–	10.00	0.3937	87.0	133.0	10.00
A90010.2	–	10.20	0.4016	87.0	133.0	10.20
A90010.3	–	10.30	0.4055	87.0	133.0	10.30
A90010.5	–	10.50	0.4134	87.0	133.0	10.50
A90011.0	–	11.00	0.4331	94.0	142.0	11.00
A90011.5	–	11.50	0.4528	94.0	142.0	11.50
A90011.8	–	11.80	0.4646	94.0	142.0	11.80
A90015/32	15/32	11.91	0.4688	110.0	146.0	11.91
A90012.0	–	12.00	0.4724	101.0	151.0	12.00
A90031/64	31/64	12.30	0.4844	111.0	149.0	12.30
A90012.5	–	12.50	0.4921	101.0	151.0	12.50
A9001/2	1/2	12.70	0.5000	101.0	151.0	12.70
A90013.0	–	13.00	0.5118	101.0	151.0	13.00
A90013.5	–	13.50	0.5315	108.0	160.0	13.50
A90014.0	–	14.00	0.5512	108.0	160.0	14.00
A9009/16	9/16	14.29	0.5625	122.0	168.0	14.29
A90015.0	–	15.00	0.5906	114.0	169.0	15.00
A90016.0	–	16.00	0.6299	120.0	178.0	16.00
A90017.0	–	17.00	0.6693	125.0	184.0	17.00
A90011/16	11/16	17.46	0.6875	143.0	194.0	17.46
A90018.0	–	18.00	0.7087	130.0	191.0	18.00
A90023/32	23/32	18.26	0.7188	130.0	191.0	18.26
A90018.5	–	18.50	0.7283	135.0	198.0	18.50
A90047/64	47/64	18.65	0.7344	135.0	198.0	18.65
A9003/4	3/4	19.05	0.7500	135.0	198.0	19.05
A90049/64	49/64	19.45	0.7656	135.0	198.0	19.45
A90019.5	–	19.50	0.7677	140.0	205.0	19.50
A90025/32	25/32	19.84	0.7813	140.0	205.0	19.84
A90020.0	–	20.00	0.7874	140.0	205.0	20.00

A940



Broca PFX HSS-E (5% Cobalto), Serie Larga, Acabo Brillante

Broca de alto rendimiento, capaz de producir agujeros precisos y de alta calidad a altas velocidades y avances (tolerancia de agujero H10). La punta autocentrante a 130° y el diseño especial parabólico de los canales ayudan a taladrar agujeros profundos en una sola pasada. Apta para la mayoría de materiales.

PFX

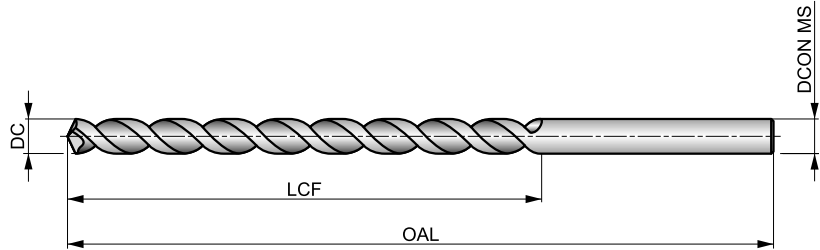

HSS-E	DIN ANSI	10xD
	Bright	
		DC h8

Grupo de Material de la pieza adecuado y condiciones de velocidad de corte iniciales (m/min) y código de avance alfabético. Tablas con avance por revolución a partir de la pag.274.

P1.1 ■ 29 F	P1.2 ■ 33 F	P1.3 ■ 34 F	P2.1 ■ 25 F	P2.2 ■ 22 G	P2.3 ■ 19 C	P3.1 ■ 25 G	P3.2 ■ 20 G	P3.3 ■ 17 C	P4.1 ■ 15 G	P4.2 ■ 13 C	P4.3 ■ 10 C	M1.1 ■ 21 C	M1.2 ■ 17 C
M2.1 ■ 18 C	M2.2 ■ 15 C	M3.1 ■ 8 E	M3.2 ■ 7 E	M3.3 ■ 6 E	M4.1 ■ 9 B	K2.1 ▣ 20 I	K2.2 ▣ 16 I	K2.3 ▣ 13 H	K3.1 ▣ 17 I	K3.2 ▣ 13 I	K3.3 ▣ 11 H	K4.1 ▣ 16 I	K4.2 ▣ 12 I
K4.3 ▣ 9 H	K4.4 ▣ 18 H	K4.5 ▣ 6 H	K5.1 ▣ 18 I	K5.2 ▣ 14 I	K5.3 ▣ 11 H	N1.1 ▣ 53 H	N1.2 ▣ 40 H	N1.3 ■ 27 N	N2.1 ▣ 62 N	N2.2 ▣ 55 N	N2.3 ▣ 40 N	N3.1 ▣ 119 G	N3.2 ▣ 70 F
N3.3 ▣ 35 F	N4.1 ▣ 55 H	N4.2 ▣ 40 F	S1.1 ■ 18 E	S1.2 ■ 13 C	S1.3 ■ 6 C								

DC >= 9.6mm menos de 10xD.

Product	DC (inch)	DC (mm)	DC (inch)	LCF (mm)	OAL (mm)	DCON MS (mm)
A9401.0	-	1.00	0.0394	33.0	56.0	1.00
A9401.1	-	1.10	0.0433	37.0	60.0	1.10
A9403/64	3/64	1.19	0.0469	29.0	57.0	1.19
A9401.2	-	1.20	0.0472	41.0	65.0	1.20
A9401.3	-	1.30	0.0512	41.0	65.0	1.30
A9401.4	-	1.40	0.0551	45.0	70.0	1.40
A9401.5	-	1.50	0.0591	45.0	70.0	1.50
A9401/16	1/16	1.59	0.0625	44.0	76.0	1.59
A9401.6	-	1.60	0.0630	50.0	76.0	1.60
A9401.7	-	1.70	0.0669	50.0	76.0	1.70
A9401.8	-	1.80	0.0709	53.0	80.0	1.80
A9401.9	-	1.90	0.0748	53.0	80.0	1.90
A9405/64	5/64	1.98	0.0781	51.0	95.0	1.98
A9402.0	-	2.00	0.0787	56.0	85.0	2.00
A9402.1	-	2.10	0.0827	56.0	85.0	2.10
A9402.2	-	2.20	0.0866	59.0	90.0	2.20
A9402.3	-	2.30	0.0906	59.0	90.0	2.30
A9403/32	3/32	2.38	0.0938	57.0	108.0	2.38
A9402.4	-	2.40	0.0945	62.0	95.0	2.40
A9402.5	-	2.50	0.0984	62.0	95.0	2.50
A9402.6	-	2.60	0.1024	62.0	95.0	2.60
A9402.7	-	2.70	0.1063	66.0	100.0	2.70
A9407/64	7/64	2.78	0.1094	64.0	117.0	2.78
A9402.8	-	2.80	0.1102	66.0	100.0	2.80
A9402.9	-	2.90	0.1142	66.0	100.0	2.90

Product	DC (inch)	DC (mm)	DC (inch)	LCF (mm)	OAL (mm)	DCON MS (mm)
A9403.0	-	3.00	0.1181	66.0	100.0	3.00
A9403.1	-	3.10	0.1220	69.0	106.0	3.10
A9401/8	1/8	3.18	0.1250	70.0	130.0	3.18
A9403.2	-	3.20	0.1260	69.0	106.0	3.20
A9403.3	-	3.30	0.1299	69.0	106.0	3.30
A9403.4	-	3.40	0.1339	73.0	112.0	3.40
A9403.5	-	3.50	0.1378	73.0	112.0	3.50
A9409/64	9/64	3.57	0.1406	76.0	137.0	3.57
A9403.6	-	3.60	0.1417	73.0	112.0	3.60
A9403.7	-	3.70	0.1457	73.0	112.0	3.70
A9403.8	-	3.80	0.1496	78.0	119.0	3.80
A9403.9	-	3.90	0.1535	78.0	119.0	3.90
A9405/32	5/32	3.97	0.1563	76.0	137.0	3.97
A9404.0	-	4.00	0.1575	78.0	119.0	4.00
A9404.1	-	4.10	0.1614	78.0	119.0	4.10
A9404.2	-	4.20	0.1654	78.0	119.0	4.20
A9404.3	-	4.30	0.1693	82.0	126.0	4.30
A9404.4	-	4.40	0.1732	82.0	126.0	4.40
A9404.5	-	4.50	0.1772	82.0	126.0	4.50
A9404.6	-	4.60	0.1811	82.0	126.0	4.60
A9403/16	3/16	4.76	0.1875	86.0	146.0	4.76
A9404.8	-	4.80	0.1890	87.0	132.0	4.80
A9404.9	-	4.90	0.1929	87.0	132.0	4.90
A9405.0	-	5.00	0.1969	87.0	132.0	5.00
A9405.1	-	5.10	0.2008	87.0	132.0	5.10



Product	DC	DC	DC	LCF	OAL	D CON MS
	(inch)	(mm)	(inch)	(mm)	(mm)	(mm)
A9405.2	–	5.20	0.2047	87.0	132.0	5.20
A9405.3	–	5.30	0.2087	87.0	132.0	5.30
A9405.4	–	5.40	0.2126	91.0	139.0	5.40
A9405.5	–	5.50	0.2165	91.0	139.0	5.50
A9405.8	–	5.80	0.2283	91.0	139.0	5.80
A9405.9	–	5.90	0.2323	91.0	139.0	5.90
A9406.0	–	6.00	0.2362	91.0	139.0	6.00
A9406.1	–	6.10	0.2402	97.0	148.0	6.10
A9406.2	–	6.20	0.2441	97.0	148.0	6.20
A9401/4	1/4	6.35	0.2500	95.0	156.0	6.35
A9406.4	–	6.40	0.2520	97.0	148.0	6.40
A9406.5	–	6.50	0.2559	97.0	148.0	6.50
A9406.6	–	6.60	0.2598	97.0	148.0	6.60
A9406.7	–	6.70	0.2638	97.0	148.0	6.70
A94017/64	17/64	6.75	0.2656	98.0	159.0	6.75
A9406.8	–	6.80	0.2677	102.0	156.0	6.80
A9406.9	–	6.90	0.2717	102.0	156.0	6.90
A9407.0	–	7.00	0.2756	102.0	156.0	7.00
A9407.2	–	7.20	0.2835	102.0	156.0	7.20
A9407.3	–	7.30	0.2874	102.0	156.0	7.30
A9407.5	–	7.50	0.2953	102.0	156.0	7.50
A9407.8	–	7.80	0.3071	109.0	165.0	7.80
A9405/16	5/16	7.94	0.3125	102.0	162.0	7.94
A9408.0	–	8.00	0.3150	109.0	165.0	8.00
A9408.2	–	8.20	0.3228	109.0	165.0	8.20
A9408.3	–	8.30	0.3268	109.0	165.0	8.30
A9408.5	–	8.50	0.3346	109.0	165.0	8.50
A9408.6	–	8.60	0.3386	115.0	175.0	8.60
A9408.7	–	8.70	0.3425	115.0	175.0	8.70
A94011/32	11/32	8.73	0.3438	105.0	165.0	8.73

Product	DC	DC	DC	LCF	OAL	D CON MS
	(inch)	(mm)	(inch)	(mm)	(mm)	(mm)
A9409.0	–	9.00	0.3543	115.0	175.0	9.00
A9409.5	–	9.50	0.3740	115.0	175.0	9.50
A9409.8	–	9.80	0.3858	121.0	184.0	9.80
A94010.0	–	10.00	0.3937	121.0	184.0	10.00
A94010.2	–	10.20	0.4016	121.0	184.0	10.20
A94010.3	–	10.30	0.4055	121.0	184.0	10.30
A94013/32	13/32	10.32	0.4063	111.0	178.0	10.32
A94010.5	–	10.50	0.4134	121.0	184.0	10.50
A94027/64	27/64	10.72	0.4219	117.0	184.0	10.72
A94011.0	–	11.00	0.4331	128.0	195.0	11.00
A9407/16	7/16	11.11	0.4375	117.0	184.0	11.11
A94011.5	–	11.50	0.4528	128.0	195.0	11.50
A94029/64	29/64	11.51	0.4531	121.0	190.0	11.51
A94011.8	–	11.80	0.4646	128.0	195.0	11.80
A94012.0	–	12.00	0.4724	134.0	205.0	12.00
A94012.2	–	12.20	0.4803	134.0	205.0	12.20
A94031/64	31/64	12.30	0.4844	121.0	197.0	12.30
A94012.5	–	12.50	0.4921	134.0	205.0	12.50
A94013.0	–	13.00	0.5118	134.0	205.0	13.00
A94017/32	17/32	13.49	0.5313	121.0	203.0	13.49
A94014.0	–	14.00	0.5512	140.0	214.0	14.00
A9409/16	9/16	14.29	0.5625	124.0	210.0	14.29
A94014.5	–	14.50	0.5709	144.0	220.0	14.50
A94015.0	–	15.00	0.5906	144.0	220.0	15.00
A94015.5	–	15.50	0.6102	149.0	227.0	15.50
A94016.0	–	16.00	0.6299	149.0	227.0	16.00
A94021/32	21/32	16.67	0.6563	130.0	229.0	16.67
A94017.0	–	17.00	0.6693	154.0	235.0	17.00
A94011/16	11/16	17.46	0.6875	137.0	235.0	17.46
A94019.0	–	19.00	0.7480	162.0	247.0	19.00

A976



Broca PFX HSS-E (5% Cobalto), Serie Extra Larga DIN 1869-1, Acabado Brillante

Recomendada para taladrar agujeros muy profundos o para aplicaciones donde se necesita un alcance adicional. Los canales parabólicos están especialmente diseñados para eliminar la necesidad de taladrar agujeros profundos en pasos cortos (picoteo). Se recomienda un punteado de centro a 130° con una broca corta PFX 3xD (para mantener la misma tolerancia del DC). Adecuada para taladrar muchos materiales.



PFX

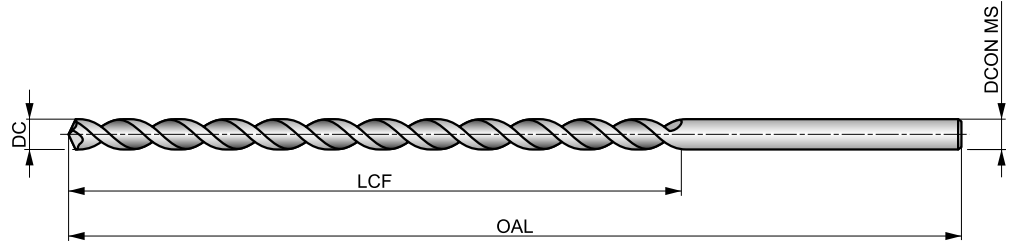

HSS-E	DIN 1869-1	15×D
130°	Bright	
λ>35°	R	DC h8

Grupo de Material de la pieza adecuado y condiciones de velocidad de corte iniciales (m/min) y código de avance alfabético. Tablas con avance por revolución a partir de la pag.274.

P1.1 29 C	P1.2 33 C	P1.3 34 C	P2.1 25 C	P2.2 22 C	P2.3 19 A	P3.1 18 C	P3.2 14 C	P3.3 12 A	P4.1 11 C	P4.2 9 A	P4.3 7 A	M1.1 16 B	M1.2 14 B
M2.1 15 B	M2.2 12 B	M3.1 8 C	M3.2 7 C	M3.3 6 C	M4.1 8 A	K2.1 20 C	K2.2 16 C	K2.3 13 A	K3.1 17 C	K3.2 13 C	K3.3 11 A	K4.1 16 C	K4.2 12 C
K4.3 19 A	K4.4 8 A	K4.5 6 A	K5.1 18 C	K5.2 14 C	K5.3 11 A	N3.1 30 D	S1.1 15 C	S1.2 11 A	S1.3 5 A				

Product	DC (inch)	DC (mm)	DC (inch)	LCF (mm)	OAL (mm)	DCON MS (mm)
A9761.5	—	1.50	0.0591	75.0	115.0	1.50
A9762.0X125	—	2.00	0.0787	85.0	125.0	2.00
A9762.1X125	—	2.10	0.0827	85.0	125.0	2.10
A9762.2X135	—	2.20	0.0866	90.0	135.0	2.20
A9762.3X135	—	2.30	0.0906	90.0	135.0	2.30
A9762.4X140	—	2.40	0.0945	95.0	140.0	2.40
A9762.5X140	—	2.50	0.0984	95.0	140.0	2.50
A9762.6X140	—	2.60	0.1024	95.0	140.0	2.60
A9762.7X150	—	2.70	0.1063	100.0	150.0	2.70
A9762.8X150	—	2.80	0.1102	100.0	150.0	2.80
A9762.9X150	—	2.90	0.1142	100.0	150.0	2.90
A9763.0X150	—	3.00	0.1181	100.0	150.0	3.00
A9763.1X155	—	3.10	0.1220	105.0	155.0	3.10
A9761/8	1/8	3.18	0.1250	105.0	155.0	3.18
A9763.2X155	—	3.20	0.1260	105.0	155.0	3.20
A9763.3X155	—	3.30	0.1299	105.0	155.0	3.30
A9763.4X165	—	3.40	0.1339	115.0	165.0	3.40
A9763.5X165	—	3.50	0.1378	115.0	165.0	3.50
A9763.6X165	—	3.60	0.1417	115.0	165.0	3.60
A9763.7X165	—	3.70	0.1457	115.0	165.0	3.70
A9763.8X175	—	3.80	0.1496	120.0	175.0	3.80
A9763.9X175	—	3.90	0.1535	120.0	175.0	3.90
A9765/32	5/32	3.97	0.1563	120.0	175.0	3.97
A9764.0X175	—	4.00	0.1575	120.0	175.0	4.00
A9764.1X175	—	4.10	0.1614	120.0	175.0	4.10
A9764.2X175	—	4.20	0.1654	120.0	175.0	4.20
A9764.3X185	—	4.30	0.1693	125.0	185.0	4.30
A9764.5X185	—	4.50	0.1772	125.0	185.0	4.50
A9764.6X185	—	4.60	0.1811	125.0	185.0	4.60
A9764.7X185	—	4.70	0.1850	125.0	185.0	4.70
A9763/16	3/16	4.76	0.1875	135.0	195.0	4.76
A9764.8X195	—	4.80	0.1890	135.0	195.0	4.80
A9765.0X195	—	5.00	0.1969	135.0	195.0	5.00

Product	DC (inch)	DC (mm)	DC (inch)	LCF (mm)	OAL (mm)	DCON MS (mm)
A9765.1X195	—	5.10	0.2008	135.0	195.0	5.10
A9765.2X195	—	5.20	0.2047	135.0	195.0	5.20
A9765.3X195	—	5.30	0.2087	135.0	195.0	5.30
A9765.5X205	—	5.50	0.2165	140.0	205.0	5.50
A9765.7X205	—	5.70	0.2244	140.0	205.0	5.70
A9765.8X205	—	5.80	0.2283	140.0	205.0	5.80
A9765.9X205	—	5.90	0.2323	140.0	205.0	5.90
A9766.0X205	—	6.00	0.2362	140.0	205.0	6.00
A9766.1X215	—	6.10	0.2402	150.0	215.0	6.10
A9766.2X215	—	6.20	0.2441	150.0	215.0	6.20
A9761/4	1/4	6.35	0.2500	150.0	215.0	6.35
A9766.4X215	—	6.40	0.2520	150.0	215.0	6.40
A9766.5X215	—	6.50	0.2559	150.0	215.0	6.50
A9766.7X215	—	6.70	0.2638	150.0	215.0	6.70
A9766.8X225	—	6.80	0.2677	155.0	225.0	6.80
A9767.0X225	—	7.00	0.2756	155.0	225.0	7.00
A9767.5X225	—	7.50	0.2953	155.0	225.0	7.50
A9765/16	5/16	7.94	0.3125	165.0	240.0	7.94
A9768.0X240	—	8.00	0.3150	165.0	240.0	8.00
A9768.5X240	—	8.50	0.3346	165.0	240.0	8.50
A97611/32	11/32	8.73	0.3438	175.0	250.0	8.73
A9769.0X250	—	9.00	0.3543	175.0	250.0	9.00
A9769.5X250	—	9.50	0.3740	175.0	250.0	9.50
A9763/8	3/8	9.52	0.3750	185.0	265.0	9.52
A97610.0X265	—	10.00	0.3937	185.0	265.0	10.00
A97610.5	—	10.50	0.4134	185.0	265.0	10.50
A97611.0	—	11.00	0.4331	195.0	280.0	11.00
A9767/16	7/16	11.11	0.4375	195.0	280.0	11.11
A97611.5	—	11.50	0.4528	195.0	280.0	11.50
A97612.0	—	12.00	0.4724	205.0	295.0	12.00
A97612.5	—	12.50	0.4921	205.0	295.0	12.50
A97613.0	—	13.00	0.5118	205.0	295.0	13.00
A97614.0 ¹⁾	—	14.00	0.5512	215.0	310.0	14.00

A977



Broca PFX HSS-E (5% Cobalto), Serie Extra Larga DIN 1869-2, Acabado Brillante

Recomendada para taladrar agujeros muy profundos y para aplicaciones donde se necesita un alcance adicional. Los canales parabólicos están especialmente diseñados para eliminar la necesidad de taladrar agujeros profundos en pasos cortos (picoteo). Se recomienda un punteado de centroje a 130° con una broca corta PFX 3xD (para mantener la misma tolerancia del DC). Adecuada para taladrar muchos materiales.

PFX

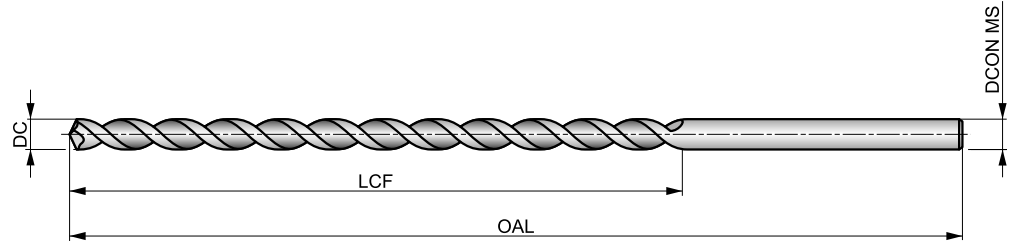

HSS-E	DIN 1869-2	20xD
130°	Bright	
λ>35°		DC h8

Grupo de Material de la pieza adecuado y condiciones de velocidad de corte iniciales (m/min) y código de avance alfabético. Tablas con avance por revolución a partir de la pag.274.

P1.1 ▣29 B	P1.2 ▣33 B	P1.3 ▣34 B	P2.1 ▣25 B	P2.2 ▣22 B	P2.3 ▣19 A	P3.1 ▣18 B	P3.2 ▣14 B	P3.3 ▣12 A	P4.1 ▣11 B	P4.2 ▣9 A	P4.3 ▣7 A	M1.1 ▣16 B	M1.2 ▣14 B
M2.1 ▣15 B	M2.2 ▣12 B	M3.1 ▣8 B	M3.2 ▣7 B	M3.3 ▣6 B	M4.1 ▣8 A	K2.1 ▣20 B	K2.2 ▣16 B	K2.3 ▣13 A	K3.1 ▣17 B	K3.2 ▣13 B	K3.3 ▣11 A	K4.1 ▣16 B	K4.2 ▣12 B
K4.3 ▣9 A	K4.4 ▣8 A	K4.5 ▣6 A	K5.1 ▣18 B	K5.2 ▣14 B	K5.3 ▣11 A	N3.1 ▣30 C	S1.1 ▣15 B	S1.2 ▣11 A	S1.3 ▣5 A				

Product	DC (inch)	DC (mm)	DC (inch)	LCF (mm)	OAL (mm)	DCON MS (mm)
A9771.5 ¹⁾	—	1.50	0.0591	100.0	150.0	1.50
A9771/16 ¹⁾	1/16	1.59	0.0625	100.0	150.0	1.59
A9772.0 ¹⁾	—	2.00	0.0787	110.0	160.0	2.00
A9773/32 ¹⁾	3/32	2.38	0.0938	115.0	170.0	2.38
A9773.0X190	—	3.00	0.1181	130.0	190.0	3.00
A9771/8	1/8	3.18	0.1250	135.0	200.0	3.18
A9773.5X210	—	3.50	0.1378	145.0	210.0	3.50
A9774.0X220	—	4.00	0.1575	150.0	220.0	4.00
A9774.5X235	—	4.50	0.1772	160.0	235.0	4.50
A9773/16	3/16	4.76	0.1875	170.0	245.0	4.76
A9775.0X245	—	5.00	0.1969	170.0	245.0	5.00
A9775.5X260	—	5.50	0.2165	180.0	260.0	5.50
A9776.0X260	—	6.00	0.2362	180.0	260.0	6.00
A9771/4	1/4	6.35	0.2500	190.0	275.0	6.35

Product	DC (inch)	DC (mm)	DC (inch)	LCF (mm)	OAL (mm)	DCON MS (mm)
A9776.5X275	—	6.50	0.2559	190.0	275.0	6.50
A9777.0X290	—	7.00	0.2756	200.0	290.0	7.00
A9778.0X305	—	8.00	0.3150	210.0	305.0	8.00
A9778.5X305	—	8.50	0.3346	210.0	305.0	8.50
A9779.0X320	—	9.00	0.3543	220.0	320.0	9.00
A9779.5X320	—	9.50	0.3740	220.0	320.0	9.50
A97710.0X340	—	10.00	0.3937	235.0	340.0	10.00
A97710.5	—	10.50	0.4134	235.0	340.0	10.50
A97711.0	—	11.00	0.4331	250.0	365.0	11.00
A97711.5	—	11.50	0.4528	250.0	365.0	11.50
A97712.0	—	12.00	0.4724	260.0	375.0	12.00
A97712.5	—	12.50	0.4921	260.0	375.0	12.50
A97713.0	—	13.00	0.5118	260.0	375.0	13.00
A97714.0 ¹⁾	—	14.00	0.5512	270.0	390.0	14.00

¹⁾ Norma Dormer

A978



Broca PFX HSS-E (5% Cobalto), Serie Extra Larga DIN 1869-3, Acabado Brillante

Recomendada para taladrar agujeros muy profundos y para aplicaciones donde se necesita un alcance adicional. Los canales parabólicos están especialmente diseñados para eliminar la necesidad de taladrar agujeros profundos en pasos cortos (picoteo). Se recomienda un punteado de centro a 130° con una broca corta PFX 3xD (para mantener la misma tolerancia del DC). Adecuada para taladrar muchos materiales.

PFX

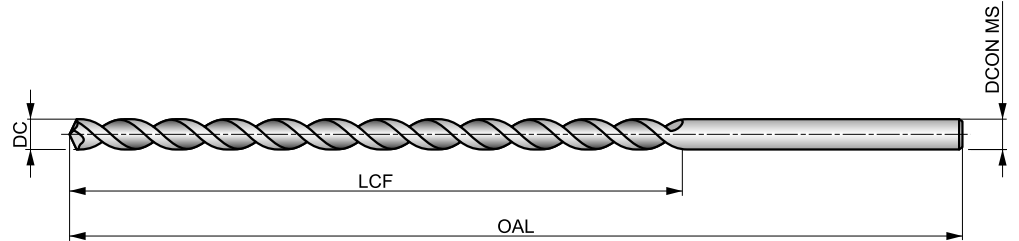

HSS-E	DIN 1869-3	25xD
130°	Bright	
λ>35°		DC h8

Grupo de Material de la pieza adecuado y condiciones de velocidad de corte iniciales (m/min) y código de avance alfabético. Tablas con avance por revolución a partir de la pag.274.

P1.1 ▣29 A	P1.2 ▣33 A	P1.3 ▣34 A	P2.1 ▣25 A	P2.2 ▣22 A	P2.3 ▣19 A	P3.1 ▣18 A	P3.2 ▣14 A	P3.3 ▣12 A	P4.1 ▣11 A	P4.2 ▣9 A	P4.3 ▣7 A	M1.1 ▣16 A	M1.2 ▣14 A
M2.1 ▣15 A	M2.2 ▣12 A	M3.1 ▣8 A	M3.2 ▣7 A	M3.3 ▣6 A	M4.1 ▣8 A	K2.1 ▣20 A	K2.2 ▣16 A	K2.3 ▣13 A	K3.1 ▣17 A	K3.2 ▣13 A	K3.3 ▣11 A	K4.1 ▣16 A	K4.2 ▣12 A
K4.3 ▣9 A	K4.4 ▣8 A	K4.5 ▣6 A	K5.1 ▣18 A	K5.2 ▣14 A	K5.3 ▣11 A	N3.1 ▣30 B	S1.1 ▣15 A	S1.2 ▣11 A	S1.3 ▣5 A				

Product	DC	DC	DC	LCF	OAL	DCON MS
	(inch)	(mm)	(inch)			
A9783.0 ¹⁾	—	3.00	0.1181	160.0	240.0	3.00
A9783.5X265	—	3.50	0.1378	180.0	265.0	3.50
A9784.0X280	—	4.00	0.1575	190.0	280.0	4.00
A9784.5X295	—	4.50	0.1772	200.0	295.0	4.50
A9785.0X315	—	5.00	0.1969	210.0	315.0	5.00
A9786.0X330	—	6.00	0.2362	225.0	330.0	6.00
A9781/4	1/4	6.35	0.2500	235.0	350.0	6.35
A9786.5X350	—	6.50	0.2559	235.0	350.0	6.50
A9787.0X370	—	7.00	0.2756	250.0	370.0	7.00
A9788.0X390	—	8.00	0.3150	265.0	390.0	8.00
A9788.5X390	—	8.50	0.3346	265.0	390.0	8.50
A9789.0X410	—	9.00	0.3543	280.0	410.0	9.00
A9789.5X410	—	9.50	0.3740	280.0	410.0	9.50
A97810.0X430	—	10.00	0.3937	295.0	430.0	10.00

¹⁾ Norma Dormer

A952



Broca HSS PFX Serie Extra Larga, Mango Cónico (DIN 1870/2), Acabado Brillante, Hélice Rápida

Broca con diseño especial parabólico de los canales diseñada para taladrar agujeros profundos en una sola pasada. Tiene punta autocentrante a 130° (se recomienda centrar con una broca PFX corta) por lo que se reduce la fuerza necesaria para producir el agujero. Apta para la mayoría de materiales.

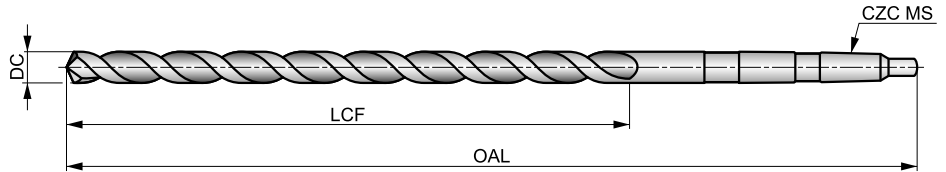

HSS	DIN 1870(2)	20xD
130°	Bright ST	
λ > 35°	R	DC h8

Grupo de Material de la pieza adecuado y condiciones de velocidad de corte iniciales (m/min) y código de avance alfabético. Tablas con avance por revolución a partir de la pag.274.

P1.1 ■ 25 G	P1.2 ■ 28 G	P1.3 ■ 29 G	P2.1 ■ 22 G	P2.2 ■ 19 E	P2.3 ■ 17 C	P3.1 ■ 12 D	P3.2 ■ 9 D	P3.3 ■ 8 C	P4.1 ■ 7 D	P4.2 ■ 6 C	P4.3 ■ 5 B	M1.1 ■ 16 C	M1.2 ■ 14 C
M2.1 ■ 15 C	M2.2 ■ 12 C	M3.1 ■ 17 E	M3.2 ■ 16 E	M3.3 ■ 15 E	M4.1 ■ 12 A	K1.1 ■ 22 G	K1.2 ■ 16 D	K1.3 ■ 12 D	K2.1 ■ 16 C	K2.2 ■ 13 C	K2.3 ■ 10 C	K3.1 ■ 14 C	K3.2 ■ 11 C
K3.3 ■ 9 C	K4.1 ■ 13 C	K4.2 ■ 10 C	K4.3 ■ 7 C	K4.4 ■ 6 C	K4.5 ■ 5 C	K5.1 ■ 15 C	K5.2 ■ 11 C	K5.3 ■ 9 C	N1.1 ■ 30 H	N1.2 ■ 23 H	N1.3 ■ 15 G	N2.1 ■ 37 F	N2.2 ■ 33 F
N2.3 ■ 24 F	N3.1 ■ 56 F	N3.2 ■ 33 G	N3.3 ■ 17 D	N4.1 ■ 30 J	N4.2 ■ 30 H	N4.3 ■ 10 F	S1.1 ■ 18 D	S1.2 ■ 10 B	S1.3 ■ 6 A	S2.1 ■ 7 C	S2.2 ■ 4 A	S3.1 ■ 5 C	S3.2 ■ 3 A
S4.1 ■ 4 C	S4.2 ■ 2 A												

DC >= 14.5mm menos de 20xD; DC > 23mm Brillante

Product	DC (mm)	DC (inch)	LCF (mm)	OAL (mm)	CZC MS
A9528.0	8.00	0.3150	210.0	330.0	MK 1
A9529.0	9.00	0.3543	220.0	345.0	MK 1
A95210.0	10.00	0.3937	235.0	360.0	MK 1
A95211.0	11.00	0.4331	250.0	375.0	MK 1
A95213.0	13.00	0.5118	260.0	395.0	MK 1
A95214.0	14.00	0.5512	275.0	410.0	MK 1
A95215.0	15.00	0.5906	275.0	425.0	MK 2
A95216.0	16.00	0.6299	295.0	445.0	MK 2
A95217.0	17.00	0.6693	295.0	445.0	MK 2
A95219.0	19.00	0.7480	310.0	465.0	MK 2

Product	DC (mm)	DC (inch)	LCF (mm)	OAL (mm)	CZC MS
A95220.0	20.00	0.7874	325.0	490.0	MK 2
A95221.0	21.00	0.8268	325.0	490.0	MK 2
A95223.0	23.00	0.9055	345.0	515.0	MK 2
A95224.0	24.00	0.9449	365.0	555.0	MK 3
A95225.0	25.00	0.9843	365.0	555.0	MK 3
A95226.0	26.00	1.0236	365.0	555.0	MK 3
A95227.0	27.00	1.0630	385.0	580.0	MK 3
A95228.0	28.00	1.1024	385.0	580.0	MK 3
A95229.0	29.00	1.1417	385.0	580.0	MK 3
A95230.0	30.00	1.1811	385.0	580.0	MK 3

Código de Material (BMC)	HSS	HSS	HSS	HSS	HSS	HSS	HSS	HSS	HSS	HSS	HSS
Grupo básico estándar (BSG)	DORMER	DIN 373	ANSI	ANSI	ANSI	ANSI	ANSI	DIN 8374	DIN 8376	DORMER	DORMER
Longitud Útil (ULDR)								4×D	4×D	2.5×D	2.5×D
Ángulo de aplicación	20°	180°						90°	180°	180°	90°
Recubrimiento	Bright	Bright	Bright	Bright	Bright	Bright	Bright	ST	ST	ST	ST
Mango											
Forma de la Hélice								λ 20-35°	λ 20-35°		
Mano (dirección de corte)	R	R	R	R		R	R	R	R	R	R

Código de Familia de Producto	G314	G125	G702	G703	G704	G705	G706	A400	A402	A413	A412
Gama de diámetros de corte PSF	4.00 - 9.00	6.50 - 20.00	1/4 - 2"	1/2 - 2.1/8	1/8 - 1.1/2	1/4 - 15/16	1/4 - 1"	M3 - M8	M3 - M10	M3 - M10	M3 - M10

P	P1	■	■	■	■	■	■	■	■	■	■
	P2	▣	■	■	■	■	■	■	■	■	■
	P3	▣	▣	■	■	■	■	■	■	■	■
	P4	■	▣	▣	▣	▣	▣	▣	▣	▣	▣
M	M1	▣	▣	▣	▣	▣	▣	▣	▣	■	■
	M2	▣	▣	▣	▣	▣	▣	▣	▣	■	■
	M3	■	■	■	■	■	■	▣	▣	▣	▣
	M4	■	■	■	■	■	■	▣	▣	▣	▣
K	K1	▣	▣	■	■	■	■	■	■	■	■
	K2	■	▣	■	■	■	■	▣	▣	▣	▣
	K3	■	▣	▣	▣	▣	▣	▣	▣	▣	▣
	K4	■	▣	▣	▣	▣	▣	▣	▣	▣	▣
	K5	■	▣	■	■	■	■	▣	▣	▣	▣
N	N1	■	■	■	■	■	■	▣	▣	▣	▣
	N2	▣	▣	▣	▣	▣	▣	▣	▣	▣	▣
	N3	■	■	■	■	■	■	▣	▣	▣	▣
	N4	■	▣	■	■	■	■	▣	▣	▣	▣
	N5	■	■	■	■	■	■	■	■	■	■
S	S1	■	■	■	■	■	■	▣	▣	▣	▣
	S2	■	■	■	■	■	■	▣	▣	▣	▣
	S3	■	■	■	■	■	■	▣	▣	▣	▣
	S4	■	■	■	■	■	■	▣	▣	▣	▣
H	H1	■	■	■	■	■	■	■	■	■	■
	H2	■	■	■	■	■	■	■	■	■	■
	H3	■	■	■	■	■	■	■	■	■	■
	H4	■	■	■	■	■	■	■	■	■	■

G314



Broca HSS Multi-Diámetro, para Chapas Metálicas, Acabado Brillante

Las brocas escalonadas cónicas tienen un diseño de varios diámetros que permite la ampliación gradual de los agujeros hasta el diámetro requerido. El mango cilíndrico reducido hace que todos los diámetros se puedan sujetar en un portabrocas y un soporte estándar. Adecuado para agrandar agujeros en muchos materiales.

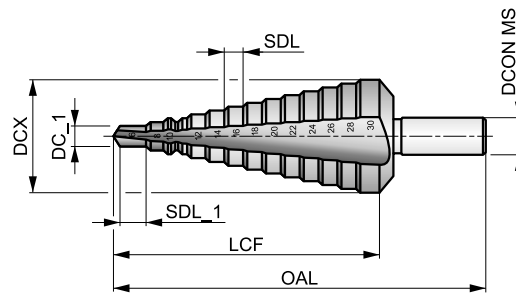

HSS	Bright	DORMER
R		20°

Grupo de Material de la pieza adecuado y condiciones de velocidad de corte iniciales (m/min) y código de avance alfabético. Tablas con avance por revolución a partir de la pag.274.

P1.1 ■ 20	P1.2 ■ 22	P1.3 ■ 23	P2.1 ■ 17	P2.2 ■ 15	P2.3 ■ 13	P3.1 ■ 12	P3.2 ■ 9	M1.1 ■ 8	M1.2 ■ 6	M2.1 ■ 7	K1.1 ■ 17	N1.1 ■ 30	N1.2 ■ 23
N1.3 ■ 15	N2.1 ■ 31	N2.2 ■ 28	N3.1 ■ 34	N3.2 ■ 20	N3.3 ■ 10	N4.1 ■ 30	N4.2 ■ 20						

SDI = Incrementos de diámetro de paso.

Product	Nr.	DC_1 (mm)	DCX (mm)	SDL (mm)	SDI (mm)	SDL_1 (mm)	LCF (mm)	OAL (mm)	DCON MS (mm)
G314412	412	4.00	12.00	5.00	4 - 5 - 6 - 7 - 8 - 9 - 10 - 11 - 12	5.00	61.0	80.0	6.00
G3141220	1220	12.00	20.00	4.00	12 - 13 - 14 - 15 - 16 - 17 - 18 - 19 - 20	4.00	55.0	76.0	9.00
G3142030	2030	20.00	30.00	4.00	20 - 21 - 22 - 23 - 24 - 25 - 26 - 27 - 28 - 29 - 30	4.00	67.0	88.0	12.00
G3143040	3040	30.00	40.00	4.00	30 - 31 - 32 - 33 - 34 - 35 - 36 - 37 - 38 - 39 - 40	4.00	74.0	98.0	13.00
G314420	420	4.00	20.00	4.00	4 - 6 - 8 - 10 - 12 - 14 - 16 - 18 - 20	4.00	48.0	76.0	8.00
G314630	630	6.00	30.00	4.00	6 - 8 - 10 - 12 - 14 - 16 - 18 - 20 - 22 - 24 - 26 - 28 - 30	4.00	73.0	98.0	10.00
G314M	M	9.00	36.00	3.00	9 - 12 - 15 - 18 - 21 - 24 - 27 - 30 - 33 - 36	3.00	57.0	86.0	12.00

G125

DORMER



Refrentador HSS a 180°, Mango Cilíndrico, Acabado Brillante

Avellanador con un ángulo de 180° diseñado para producir agujeros para tornillos de cabeza estándar. Tiene un piloto sólido (disponible para diferentes tolerancias de agujero premecanizado), que ayuda a guiar con precisión el avellanado en agujeros de tamaño métrico estándar. Adecuado para avellanar agujeros en muchos materiales.

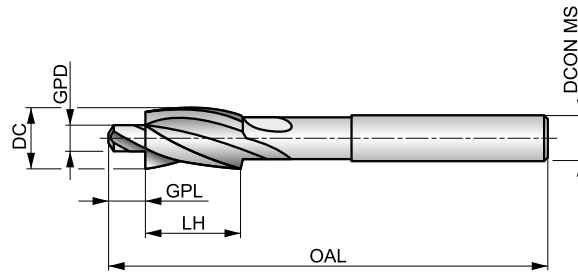

HSS	Bright	DIN 373
R	180°	

Grupo de Material de la pieza adecuado y condiciones de velocidad de corte iniciales (m/min) y código de avance alfabético. Tablas con avance por revolución a partir de la pag.274.

P1.1 ■ 20 E	P1.2 ■ 22 E	P1.3 ■ 23 E	P2.1 ■ 17 E	P2.2 ■ 15 D	P2.3 ■ 13 C	P3.1 ■ 12 D	P3.2 ■ 9 D	P3.3 ■ 8 C	P4.1 ■ 7 D	P4.2 ■ 6 C	M1.1 ■ 8 D	M1.2 ■ 6 D	M2.1 ■ 7 D
M2.2 ■ 6 D	M2.3 ■ 5 C	K1.1 ■ 17 E	K1.2 ■ 12 E	K1.3 ■ 11 E	K2.1 ■ 15 D	K2.2 ■ 12 D	K2.3 ■ 10 C	K3.1 ■ 13 D	K3.2 ■ 10 D	K4.1 ■ 12 D	K4.2 ■ 9 D	K5.1 ■ 14 D	K5.2 ■ 10 D
N1.1 ■ 30 G	N1.2 ■ 23 G	N1.3 ■ 15 G	N2.1 ■ 31 G	N2.2 ■ 28 G	N2.3 ■ 20 G	N3.1 ■ 34 C	N3.2 ■ 20 C	N3.3 ■ 10 C	N4.1 ■ 30 C	N4.2 ■ 20 C			

DCON MS tolerancia h9.

Product	DC (mm)	GPD (mm)	CZC MS	GPL (mm)	OAL (mm)	LH (mm)	DCON MS (mm)	NOF
G1256.5X3.2 ¹⁾	6.50	3.20	M 3 f	4.50	71.0	14.0	5.00	3
G1256.5X3.4 ²⁾	6.50	3.40	M 3 m	4.50	71.0	14.0	5.00	3
G1258.0X3.3 ³⁾	8.00	3.30	M 4 t	5.00	71.0	14.0	5.00	3
G1258.0X4.3 ¹⁾	8.00	4.30	M 4 f	5.00	71.0	14.0	5.00	3
G1258.0X4.5 ²⁾	8.00	4.50	M 4 m	5.00	71.0	14.0	5.00	3
G12510.0X4.2 ³⁾	10.00	4.20	M 5 t	5.50	80.0	18.0	8.00	3
G12510.0X5.3 ¹⁾	10.00	5.30	M 5 f	5.50	80.0	18.0	8.00	3
G12510.0X5.5 ²⁾	10.00	5.50	M 5 m	5.50	80.0	18.0	8.00	3
G12511.0X5.0 ³⁾	11.00	5.00	M 6 t	6.00	80.0	18.0	8.00	3
G12511.0X6.4 ¹⁾	11.00	6.40	M 6 f	6.00	80.0	18.0	8.00	3
G12511.0X6.6 ²⁾	11.00	6.60	M 6 m	6.00	80.0	18.0	8.00	3
G12515.0X6.8 ³⁾	15.00	6.80	M 8 t	8.00	100.0	22.0	12.50	3
G12515.0X8.4 ¹⁾	15.00	8.40	M 8 f	8.00	100.0	22.0	12.50	3
G12515.0X9.0 ²⁾	15.00	9.00	M 8 m	8.00	100.0	22.0	12.50	3
G12518.0X8.5 ³⁾	18.00	8.50	M 10 t	10.00	100.0	22.0	12.50	3
G12518.0X10.5 ¹⁾	18.00	10.50	M 10 f	10.00	100.0	22.0	12.50	3
G12518.0X11.0 ²⁾	18.00	11.00	M 10 m	10.00	100.0	22.0	12.50	3
G12520.0X10.2 ³⁾	20.00	10.20	M 12 t	10.00	100.0	22.0	12.50	3
G12520.0X13.0 ¹⁾	20.00	13.00	M 12 f	10.00	100.0	22.0	12.50	3
G12520.0X13.5 ²⁾	20.00	13.50	M 12 m	10.00	100.0	22.0	12.50	3

¹⁾ f= Para agujero pasante fino
²⁾ m= Para agujero pasante medio
³⁾ t= para agujero roscado

G702



Cuerpo avellanador HSS con mango reducido, tipo piloto intercambiable

Cuerpo de avellanador de mango cilíndrico utilizado junto con pilotos desmontables para agrandar la parte superior de un agujero taladrado realizando un avellanado de fondo plano. En el cuerpo se monta un piloto desmontable sin corte G704 que sigue el agujero existente para guiar y centrar la operación de corte del avellanador.

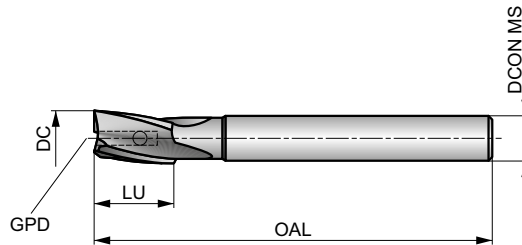

HSS	Bright	ANSI
R		

Grupo de Material de la pieza adecuado y condiciones de velocidad de corte iniciales (m/min) y código de avance alfabético. Tablas con avance por revolución a partir de la pag.274.

P1.1 ■ 20 E	P1.2 ■ 22 E	P1.3 ■ 23 E	P2.1 ■ 17 E	P2.2 ■ 15 D	P2.3 ■ 13 C	P3.1 ■ 12 D	P3.2 ■ 9 D	P3.3 ■ 8 C	P4.1 ■ 7 D	P4.2 ■ 6 C	P4.3 ■	M1.1 ■ 8 D	M1.2 ■ 6 D
M2.1 ■ 7 D	M2.2 ■ 6 D	M2.3 ■ 5 C	K1.1 ■ 17 E	K1.2 ■ 12 E	K1.3 ■ 11 E	K2.1 ■ 15 D	K2.2 ■ 12 D	K2.3 ■ 10 C	K3.1 ■ 13 D	K3.2 ■ 10 D	K4.1 ■ 12 D	K4.2 ■ 9 D	K5.1 ■ 14 D
K5.2 ■ 10 D	N1.1 ■ 30 G	N1.2 ■ 23 G	N1.3 ■ 15 G	N2.1 ■ 31 G	N2.2 ■ 28 G	N2.3 ■ 20 G	N3.1 ■ 34 C	N3.2 ■ 20 C	N3.3 ■ 10 C	N4.1 ■ 30 C	N4.2 ■ 20 C		

Product	DC (inch)	DC (inch)	LU (inch)	OAL (inch)	DCON MS (inch)	NOF	GPD (inch)	GPDN (inch)	GPDX (inch)
G7021/4	1/4	0.2500	3/4	3.13/16	15/64	3	3/32	1/8	3/16
G7029/32	9/32	0.2813	3/4	3.13/16	17/64	3	3/32	1/8	7/32
G7025/16	5/16	0.3125	3/4	3.13/16	19/64	3	3/32	1/8	1/4
G70211/32	11/32	0.3438	3/4	3.13/16	5/16	3	3/32	1/8	9/32
G7023/8	3/8	0.3750	1"	4.1/16	5/16	3	5/32	3/16	5/16
G70213/32	13/32	0.4063	1"	4.1/16	3/8	3	5/32	3/16	11/32
G7027/16	7/16	0.4375	1"	4.1/16	3/8	3	5/32	3/16	3/8
G70215/32	15/32	0.4688	1.1/4	4.5/16	7/16	3	3/16	3/16	13/32
G7021/2	1/2	0.5000	1.1/4	4.5/16	7/16	3	3/16	3/16	7/16
G7029/16	9/16	0.5625	1.1/4	4.5/16	1/2	3	3/16	3/16	1/2
G70219/32	19/32	0.5938	1.1/4	5.1/8	1/2	3	3/16	3/16	17/32
G7025/8	5/8	0.6250	1.1/4	5.1/8	1/2	3	3/16	3/16	9/16
G70211/16	11/16	0.6875	1.1/4	5.1/8	1/2	3	3/16	3/16	5/8
G7023/4	3/4	0.7500	1.1/2	5.3/8	1/2	3	1/4	5/16	11/16
G70225/32	25/32	0.7813	1.1/2	5.3/8	5/8	3	1/4	5/16	23/32
G70213/16	13/16	0.8125	1.1/2	5.3/8	5/8	3	1/4	5/16	3/4
G70227/32	27/32	0.8438	1.1/2	5.3/8	3/4	3	1/4	5/16	25/32
G7027/8	7/8	0.8750	1.1/2	5.3/8	3/4	3	1/4	5/16	13/16
G7021	1"	1.0000	1.3/4	6.3/8	3/4	3	5/16	3/8	15/16
G7022	2"	2.0000	2.1/2	8.3/8	1.1/2	5	1/2	9/16	1.15/16

G703



Cuerpo avellanador HSS con mango cónico, tipo piloto intercambiable

Cuerpo de avellanador con mango cónico Morse utilizado junto con pilotos desmontables para agrandar la parte superior de un agujero taladrado realizando un avellanado de fondo plano. En el cuerpo se monta un piloto desmontable sin corte G704 que sigue el agujero existente para guiar y centrar la operación de corte del avellanador.

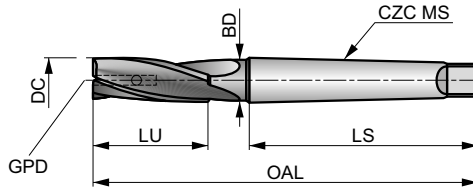

HSS	Bright	ANSI
R		

Grupo de Material de la pieza adecuado y condiciones de velocidad de corte iniciales (m/min) y código de avance alfabético. Tablas con avance por revolución a partir de la pag.274.

P1.1 ■ 20 E	P1.2 ■ 22 E	P1.3 ■ 23 E	P2.1 ■ 17 E	P2.2 ■ 15 D	P2.3 ■ 13 C	P3.1 ■ 12 D	P3.2 ■ 9 D	P3.3 ■ 8 C	P4.1 ■ 7 D	P4.2 ■ 6 C	P4.3 ■	M1.1 ■ 8 D	M1.2 ■ 6 D
M2.1 ■ 7 D	M2.2 ■ 6 D	M2.3 ■ 5 C	K1.1 ■ 17 E	K1.2 ■ 12 E	K1.3 ■ 11 E	K2.1 ■ 15 D	K2.2 ■ 12 D	K2.3 ■ 10 C	K3.1 ■ 13 D	K3.2 ■ 10 D	K4.1 ■ 12 D	K4.2 ■ 9 D	K5.1 ■ 14 D
K5.2 ■ 10 D	N1.1 ■ 30 G	N1.2 ■ 23 G	N1.3 ■ 15 G	N2.1 ■ 31 G	N2.2 ■ 28 G	N2.3 ■ 20 G	N3.1 ■ 34 C	N3.2 ■ 20 C	N3.3 ■ 10 C	N4.1 ■ 30 C	N4.2 ■ 20 C		

Product	DC (inch)	DC (inch)	LU (inch)	OAL (inch)	CZC MS	BD (inch)	LS (inch)	NOF	GPD (inch)	GPDN (inch)	GPDX (inch)
G7031/2	1/2	0.5000	1.1/4	4.5/16	1	29/64	2.9/16	3	3/16	1/4	7/16
G70311/16	11/16	0.6875	1.1/4	5.1/8	2	5/8	3.1/8	3	3/16	1/4	5/8
G7033/4	3/4	0.7500	1.1/2	5.3/8	2	21/32	3.1/8	3	1/4	5/16	11/16
G70313/16	13/16	0.8125	1.1/2	5.3/8	2	21/32	3.1/8	3	1/4	5/16	3/4
G7037/8	7/8	0.8750	1.1/2	5.3/8	2	21/32	3.1/8	3	1/4	5/16	13/16
G70315/16	15/16	0.9375	1.1/2	6.1/8	3	7/8	3.7/8	3	1/4	5/16	7/8
G7031	1"	1.0000	1.3/4	6.3/8	3	7/8	3.7/8	3	5/16	3/8	15/16
G7031.1/16	1.1/16	1.0625	1.3/4	6.3/8	3	7/8	3.7/8	3	5/16	3/8	1"
G7031.1/8	1.1/8	1.1250	1.3/4	6.3/8	3	7/8	3.7/8	3	5/16	3/8	1.1/16
G7031.3/16	1.3/16	1.1875	1.3/4	6.3/8	3	7/8	3.7/8	3	5/16	3/8	1.1/8
G7031.1/4	1.1/4	1.2500	2"	6.5/8	3	7/8	3.7/8	5	3/8	7/16	1.3/16
G7031.3/8	1.3/8	1.3750	2"	6.5/8	3	7/8	3.7/8	5	3/8	7/16	1.5/16
G7031.1/2	1.1/2	1.5000	2"	7.7/8	4	1.3/16	4.7/8	5	3/8	7/16	1.7/16
G7031.5/8	1.5/8	1.6250	2.1/4	8.1/8	4	1.3/8	4.7/8	5	7/16	1/2	1.9/16
G7032	2"	2.0000	2.1/2	8.3/8	4	1.1/2	4.7/8	5	1/2	9/16	1.5/16
G7032.1/8	2.1/8	2.1250	2.1/2	9.7/8	5	1.3/4	6.1/8	5	1/2	9/16	2.1/16

G704



Piloto para avellanador HSS, desmontable

Pilotos guía desmontables sin corte para utilizar con cuerpos de avellanador para seguir el agujero existente en la pieza. Varios pilotos con el mismo diámetro de montaje (mango) se ajustarán al diámetro de montaje del cuerpo del avellanador. Asegúrese de que el diámetro de montaje del piloto coincide con el diámetro de montaje del cuerpo



HSS	Bright	ANSI
		

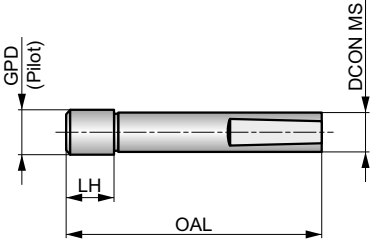

Product	GPD (inch)	DCON MS (inch)	LH (inch)	OAL (inch)
G7041/8X3/32	1/8	3/32	0.125	1.1/4
G7045/32X3/32	5/32	3/32	0.188	1.5/16
G7043/16X3/32	3/16	3/32	0.188	1.5/16
G7047/32X3/32	7/32	3/32	0.250	1.3/8
G7041/4X3/32	1/4	3/32	0.250	1.3/8
G7041/8X1/8	1/8	1/8	0.125	1.7/16
G7045/32X1/8	5/32	1/8	0.188	1.1/2
G7043/16X1/8	3/16	1/8	0.188	1.1/2
G7047/32X1/8	7/32	1/8	0.250	1.9/16
G7041/4X1/8	1/4	1/8	0.250	1.9/16
G7049/32X1/8	9/32	1/8	0.313	1.5/8
G7045/16X1/8	5/16	1/8	0.313	1.5/8
G7043/8X1/8	3/8	1/8	0.375	1.11/16
G7047/16X1/8	7/16	1/8	0.438	1.3/4
G7041/2X1/8	1/2	1/8	0.500	1.13/16
G7043/16X5/32	3/16	5/32	0.188	1.9/16
G7047/32X5/32	7/32	5/32	0.250	1.5/8
G7041/4X5/32	1/4	5/32	0.250	1.5/8
G7049/32X5/32	9/32	5/32	0.313	1.11/16
G7045/16X5/32	5/16	5/32	0.313	1.11/16
G7043/8X5/32	3/8	5/32	0.375	1.3/4
G7043/16X3/16	3/16	3/16	0.250	1.7/8
G7047/32X3/16	7/32	3/16	0.250	1.7/8
G7041/4X3/16	1/4	3/16	0.250	1.7/8
G7049/32X3/16	9/32	3/16	0.313	1.15/16
G7045/16X3/16	5/16	3/16	0.313	1.15/16
G70411/32X3/16	11/32	3/16	0.375	2"
G7043/8X3/16	3/8	3/16	0.375	2"
G70413/32X3/16	13/32	3/16	0.438	2.1/16
G7047/16X3/16	7/16	3/16	0.438	2.1/16
G70415/32X3/16	15/32	3/16	0.500	2.1/8
G7041/2X3/16	1/2	3/16	0.500	2.1/8
G7049/16X3/16	9/16	3/16	0.563	2.3/16
G7045/8X3/16	5/8	3/16	0.563	2.3/16
G70413/16X3/16	13/16	3/16	0.813	2.7/16
G7047/8X3/16	7/8	3/16	0.875	2.1/2
G7041/4X1/4	1/4	1/4	0.250	1.11/16
G7049/32X1/4	9/32	1/4	0.313	1.3/4
G7045/16X1/4	5/16	1/4	0.313	1.3/4

Product	GPD (inch)	DCON MS (inch)	LH (inch)	OAL (inch)
G7043/8X1/4	3/8	1/4	0.375	1.13/16
G7047/16X1/4	7/16	1/4	0.438	1.7/8
G7041/2X1/4	1/2	1/4	0.500	1.15/16
G70417/32X1/4	17/32	1/4	0.563	2"
G7049/16X1/4	9/16	1/4	0.563	2"
G7045/8X1/4	5/8	1/4	0.625	2.1/16
G70411/16X1/4	11/16	1/4	0.688	2.1/8
G7043/4X1/4	3/4	1/4	0.750	2.3/16
G70413/16X1/4	13/16	1/4	0.875	2.5/16
G7041X1/4	1"	1/4	1.000	2.7/16
G7043/8X5/16	3/8	5/16	0.375	2"
G7047/16X5/16	7/16	5/16	0.438	2.1/16
G7041/2X5/16	1/2	5/16	0.500	2.1/8
G7049/16X5/16	9/16	5/16	0.563	2.3/16
G7045/8X5/16	5/8	5/16	0.625	2.1/4
G70411/16X5/16	11/16	5/16	0.688	2.5/16
G7043/4X5/16	3/4	5/16	0.750	2.3/8
G70413/16X5/16	13/16	5/16	0.875	2.1/2
G70415/16X5/16	15/16	5/16	1.000	2.5/8
G7041X5/16	1"	5/16	1.000	2.5/8
G7047/16X3/8	7/16	3/8	0.438	2.5/16
G7041/2X3/8	1/2	3/8	0.500	2.3/8
G7049/16X3/8	9/16	3/8	0.563	2.7/16
G7045/8X3/8	5/8	3/8	0.625	2.1/2
G70411/16X3/8	11/16	3/8	0.688	2.9/16
G7043/4X3/8	3/4	3/8	0.750	2.5/8
G70413/16X3/8	13/16	3/8	0.875	2.3/4
G7047/8X3/8	7/8	3/8	0.875	2.3/4
G70415/16X3/8	15/16	3/8	1.000	2.5/8
G7049/16X7/16	9/16	7/16	0.625	2.7/8
G70411/16X7/16	11/16	7/16	0.750	3"
G7043/4X7/16	3/4	7/16	0.750	3"
G70413/16X7/16	13/16	7/16	0.875	3.1/8
G7047/8X7/16	7/8	7/16	0.875	3.1/8
G70415/16X7/16	15/16	7/16	1.000	3.1/4
G7041X7/16	1"	7/16	1.000	3.1/4
G7049/16X1/2	9/16	1/2	0.625	3.1/8
G7041X1/2	1"	1/2	1.000	3.1/2
G7041.1/2X1/2	1.1/2	1/2	1.500	4"

G705



Cuerpo avellanador HSS de serie larga para aeronaves, tipo piloto intercambiable

Cuerpo de avellanador de mango cilíndrico de serie larga para aeronaves utilizado junto con pilotos desmontables para agrandar la parte superior de un agujero taladrado realizando un avellanado de fondo plano. En el cuerpo se monta un piloto desmontable sin corte G704 que sigue el agujero existente para guiar y centrar la operación de corte del avellanador.

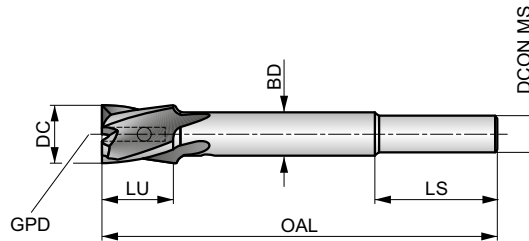

HSS	Bright	ANSI
R		

Grupo de Material de la pieza adecuado y condiciones de velocidad de corte iniciales (m/min) y código de avance alfabético. Tablas con avance por revolución a partir de la pag.274.

P1.1 ■ 20 E	P1.2 ■ 22 E	P1.3 ■ 23 E	P2.1 ■ 17 E	P2.2 ■ 15 D	P2.3 ■ 13 C	P3.1 ■ 12 D	P3.2 ■ 9 D	P3.3 ■ 8 C	P4.1 ■ 7 D	P4.2 ■ 6 C	M1.1 ■ 8 D	M1.2 ■ 6 D	M2.1 ■ 7 D
M2.2 ■ 6 D	M2.3 ■ 5 C	K1.1 ■ 17 E	K1.2 ■ 12 E	K1.3 ■ 11 E	K2.1 ■ 15 D	K2.2 ■ 12 D	K2.3 ■ 10 C	K3.1 ■ 13 D	K3.2 ■ 10 D	K4.1 ■ 12 D	K4.2 ■ 9 D	K5.1 ■ 14 D	K5.2 ■ 10 D
N1.1 ■ 30 G	N1.2 ■ 23 G	N1.3 ■ 15 G	N2.1 ■ 31 G	N2.2 ■ 28 G	N2.3 ■ 20 G	N3.1 ■ 34 C	N3.2 ■ 20 C	N3.3 ■ 10 C	N4.1 ■ 30 C	N4.2 ■ 20 C			

Product	DC (inch)	DC (inch)	LU (inch)	OAL (inch)	DCON MS (inch)	LS (inch)	BD (inch)	NOF	GPD (inch)	GPDN (inch)	GPDX (inch)
G7051/4	1/4	0.2500	1/2	4	15/64	15/64	15/64	4	3/32	1/8	3/16
G7055/16	5/16	0.3125	1/2	4	19/64	19/64	19/64	4	3/32	1/8	1/4
G7053/8	3/8	0.3750	5/8	4	5/16	5/16	5/16	4	3/32	1/8	5/16
G7057/16	7/16	0.4375	5/8	4	3/8	3/8	3/8	4	1/8	3/16	3/8
G7051/2	1/2	0.5000	5/8	4.1/4	7/16	7/16	7/16	4	1/8	1/8	7/16
G70517/32	17/32	0.5313	5/8	4.1/4	1/2	1/2	1/2	4	1/8	1/8	1/2
G7059/16	9/16	0.5625	5/8	4.1/4	1/2	1/2	1/2	4	1/8	1/8	1/2
G70519/32	19/32	0.5938	5/8	4.1/4	1/2	9/16	9/16	4	1/8	1/8	1/2
G7055/8	5/8	0.6250	5/8	4.1/4	1/2	9/16	9/16	4	1/8	1/8	1/2
G70521/32	21/32	0.6563	5/8	5.3/8	1/2	9/16	9/16	4	3/16	3/16	5/8
G70511/16	11/16	0.6875	5/8	5.3/8	1/2	5/8	5/8	4	3/16	3/16	5/8
G7053/4	3/4	0.7500	3/4	5.3/8	1/2	11/16	11/16	4	3/16	3/16	5/8
G70525/32	25/32	0.7813	3/4	5.3/8	1/2	11/16	11/16	4	3/16	3/16	5/8
G70513/16	13/16	0.8125	3/4	5.3/8	1/2	3/4	3/4	4	3/16	3/16	5/8
G7057/8	7/8	0.8750	15/16	5.3/8	1/2	3/4	3/4	4	3/16	3/16	13/16
G70515/16	15/16	0.9375	15/16	5.3/8	1/2	3/4	3/4	4	3/16	3/16	7/8

G706



Cuerpo avellanador HSS de serie corta para aeronaves, tipo piloto intercambiable

Cuerpo de avellanador de mango cilíndrico de serie corta para aeronaves utilizado junto con pilotos desmontables para agrandar la parte superior de un agujero taladrado realizando un avellanado de fondo plano. En el cuerpo se monta un piloto desmontable sin corte G704 que sigue el agujero existente para guiar y centrar la operación de corte del avellanador.

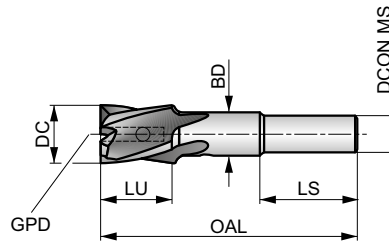

HSS	Bright	ANSI
R		

Grupo de Material de la pieza adecuado y condiciones de velocidad de corte iniciales (m/min) y código de avance alfabético. Tablas con avance por revolución a partir de la pag.274.

P1.1 ■ 20 E	P1.2 ■ 22 E	P1.3 ■ 23 E	P2.1 ■ 17 E	P2.2 ■ 15 D	P2.3 ■ 13 C	P3.1 ■ 12 D	P3.2 ■ 9 D	P3.3 ■ 8 C	P4.1 ■ 7 D	P4.2 ■ 6 C	M1.1 ■ 8 D	M1.2 ■ 6 D	M2.1 ■ 7 D
M2.2 ■ 6 D	M2.3 ■ 5 C	K1.1 ■ 17 E	K1.2 ■ 12 E	K1.3 ■ 11 E	K2.1 ■ 15 D	K2.2 ■ 12 D	K2.3 ■ 10 C	K3.1 ■ 13 D	K3.2 ■ 10 D	K4.1 ■ 12 D	K4.2 ■ 9 D	K5.1 ■ 14 D	K5.2 ■ 10 D
N1.1 ■ 30 G	N1.2 ■ 23 G	N1.3 ■ 15 G	N2.1 ■ 31 G	N2.2 ■ 28 G	N2.3 ■ 20 G	N3.1 ■ 34 C	N3.2 ■ 20 C	N3.3 ■ 10 C	N4.1 ■ 30 C	N4.2 ■ 20 C			

Product	DC (inch)	DC (inch)	LU (inch)	OAL (inch)	DCON MS (inch)	LS (inch)	BD (inch)	NOF	GPD (inch)	GPDN (inch)	GPDX (inch)
G7061/4	1/4	0.2500	1/2	2.3/8	1/4	1.1/8	15/64	4	3/32	1/8	3/16
G7065/16	5/16	0.3125	1/2	2.3/8	1/4	7/8	17/64	4	3/32	1/8	1/4
G70611/32	11/32	0.3438	1/2	2.3/8	1/4	7/8	19/64	4	3/32	1/8	9/32
G7063/8	3/8	0.3750	1/2	2.3/8	1/4	7/8	5/16	4	3/32	3/16	5/16
G70613/32	13/32	0.4063	1/2	2.13/16	1/4	7/8	5/16	4	1/8	3/16	11/32
G7067/16	7/16	0.4375	1/2	2.13/16	1/4	7/8	5/16	4	1/8	3/16	3/8
G70615/32	15/32	0.4688	1/2	2.13/16	1/4	7/8	5/16	4	1/8	1/4	13/32
G7061/2	1/2	0.5000	1/2	2.13/16	1/4	7/8	3/8	4	1/8	1/4	7/16
G70617/32	17/32	0.5313	1/2	2.13/16	1/4	7/8	3/8	4	1/8	1/4	15/32
G7069/16	9/16	0.5625	1/2	2.13/16	1/4	7/8	3/8	4	1/8	1/4	1/2
G70611/16	11/16	0.6875	1/2	2.13/16	1/4	7/8	1/2	4	1/8	1/4	5/8
G7063/4	3/4	0.7500	1/2	2.13/16	1/4	7/8	1/2	4	3/16	5/16	11/16
G70613/16	13/16	0.8125	1/2	2.13/16	1/4	7/8	1/2	4	3/16	5/16	3/4
G7067/8	7/8	0.8750	1/2	2.13/16	1/4	7/8	1/2	4	3/16	5/16	13/16
G7061	1"	1.0000	1/2	2.13/16	1/4	7/8	1/2	4	3/16	3/8	15/16

A400



Broca HSS Bidiametral a 90°, Acabado Templado al Vapor

Una herramienta versátil, diseñada para taladrar agujeros pasantes achaflanados para tornillos métricos estándar. Punta a 118° y avellanado a 90°. Adecuada para máquinas convencionales y CNC. El acabado templado al vapor actúa reteniendo el fluido de corte y evitando que la viruta se suelde a la herramienta. Adecuada para taladrar la mayoría de materiales.

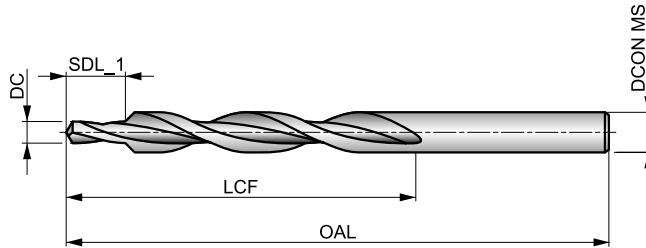

HSS	DIN 8374	4xD
90°	ST	
λ 20-35°	R	118°

Grupo de Material de la pieza adecuado y condiciones de velocidad de corte iniciales (m/min) y código de avance alfabético. Tablas con avance por revolución a partir de la pag.274.

P1.1 ■ 29 G	P1.2 ■ 33 G	P1.3 ■ 34 G	P2.1 ■ 25 G	P2.2 ■ 22 E	P2.3 ■ 19 C	P3.1 ■ 15 E	P3.2 ■ 12 E	P3.3 ■ 10 C	P4.1 ■ 9 E	P4.2 ■ 7 C	P4.3 ■ 6 C	M1.1 ■ 22 E	M1.2 ■ 19 E
M2.1 ■ 20 E	M2.2 ■ 16 E	M3.1 ■ 10 G	M3.2 ■ 9 G	M3.3 ■ 8 G	M4.1 ■ 12 C	K1.1 ■ 30 G	K1.2 ■ 22 E	K1.3 ■ 17 E	K2.1 ■ 23 E	K2.2 ■ 19 E	K2.3 ■ 15 C	K3.1 ■ 21 E	K3.2 ■ 16 E
K3.3 ■ 13 C	K4.1 ■ 19 E	K4.2 ■ 14 E	K4.3 ■ 11 C	K4.4 ■ 9 C	K4.5 ■ 8 C	K5.1 ■ 22 E	K5.2 ■ 16 E	K5.3 ■ 13 C	N1.1 ■ 45 E	N1.2 ■ 34 E	N1.3 ■ 23 E	N2.1 ■ 49 E	N2.2 ■ 44 E
N2.3 ■ 32 E	N3.1 ■ 68 E	N3.2 ■ 40 E	N3.3 ■ 20 E	N4.1 ■ 30 I	S1.1 ■ 23 E	S1.2 ■ 14 C	S1.3 ■ 8 A	S2.1 ■ 8 C	S2.2 ■ 6 A	S3.1 ■ 6 C	S3.2 ■ 4 A	S4.1 ■ 5 C	S4.2 ■ 3 A

Product	TDZ	DC	DC	LCF	OAL	SDL_1	DCON MS
		(mm)	(inch)				
A400M3	M3	3.20	0.1260	57.0	93.0	9.00	6.00
A400M4	M4	4.30	0.1693	75.0	117.0	11.00	8.00
A400M5	M5	5.30	0.2087	87.0	133.0	13.00	10.00
A400M6	M6	6.40	0.2520	94.0	142.0	15.00	11.50
A400M8	M8	8.40	0.3307	114.0	169.0	19.00	15.00

A402



Broca HSS Escalonada, Acabado Templado al Vapor

Incluye un piloto a 118 ° y un avellanado a 180 ° con diámetro y longitud de piloto específicos, recomendados para crear agujeros pasantes avellanados para tornillos métricos estándar. El acabado templado al vapor retiene el fluido de corte y evita la soldadura de la viruta a la herramienta. Adecuada para taladrar muchos materiales.

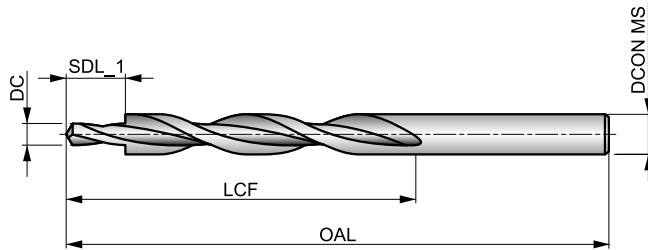

HSS	DIN 8376	4xD
180°	ST	
λ 20-35°	R	118°

Grupo de Material de la pieza adecuado y condiciones de velocidad de corte iniciales (m/min) y código de avance alfabético. Tablas con avance por revolución a partir de la pag.274.

P1.1 ■ 29 G	P1.2 ■ 33 G	P1.3 ■ 34 G	P2.1 ■ 25 G	P2.2 ■ 22 E	P2.3 ■ 19 C	P3.1 ■ 15 E	P3.2 ■ 12 E	P3.3 ■ 10 C	P4.1 ■ 9 E	P4.2 ■ 7 C	P4.3 ■ 6 C	M1.1 ■ 22 E	M1.2 ■ 19 E
M2.1 ■ 20 E	M2.2 ■ 16 E	M3.1 ■ 10 G	M3.2 ■ 9 G	M3.3 ■ 8 G	M4.1 ■ 12 C	K1.1 ■ 30 G	K1.2 ■ 22 E	K1.3 ■ 17 E	K2.1 ■ 23 E	K2.2 ■ 19 E	K2.3 ■ 15 C	K3.1 ■ 21 E	K3.2 ■ 16 E
K3.3 ■ 13 C	K4.1 ■ 19 E	K4.2 ■ 14 E	K4.3 ■ 11 C	K4.4 ■ 9 C	K4.5 ■ 8 C	K5.1 ■ 22 E	K5.2 ■ 16 E	K5.3 ■ 13 C	N1.1 ■ 45 E	N1.2 ■ 34 E	N1.3 ■ 23 E	N2.1 ■ 49 E	N2.2 ■ 44 E
N2.3 ■ 32 E	N3.1 ■ 68 E	N3.2 ■ 40 E	N3.3 ■ 20 E	N4.1 ■ 30 I	S1.1 ■ 23 E	S1.2 ■ 14 C	S1.3 ■ 8 A	S2.1 ■ 8 C	S2.2 ■ 6 A	S3.1 ■ 6 C	S3.2 ■ 4 A	S4.1 ■ 5 C	S4.2 ■ 3 A

Product	TDZ	DC	DC	LCF	OAL	SDL_1	DCON MS
		(mm)	(inch)				
A402M3	M3	3.40	0.1339	57.0	93.0	9.00	6.00
A402M4	M4	4.50	0.1772	75.0	117.0	11.00	8.00
A402M5	M5	5.50	0.2165	87.0	133.0	13.00	10.00
A402M6	M6	6.60	0.2598	94.0	142.0	15.00	11.00
A402M8	M8	9.00	0.3543	114.0	169.0	19.00	15.00
A402M10	M10	11.00	0.4331	130.0	191.0	23.00	18.00

A413

DORMER



Broca HSS Escalonada, Acabado Templado al Vapor

Una herramienta versátil recomendada para producir agujeros avellanados para tornillos métricos estándar. Piloto a 118° y avellanado a 180°. El acabado templado al vapor actúa reteniendo el fluido de corte y evitando que la viruta se suelde a la herramienta. Adecuada para taladrar la mayoría de materiales. Adecuada para máquinas convencionales y CNC.

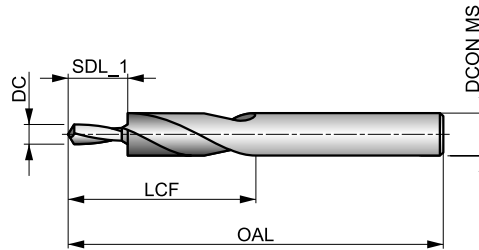

HSS		2.5xD
180°		
R	118°	

Grupo de Material de la pieza adecuado y condiciones de velocidad de corte iniciales (m/min) y código de avance alfabético. Tablas con avance por revolución a partir de la pag.274.

P1.1 ■ 29 I	P1.2 ■ 33 I	P1.3 ■ 34 I	P2.1 ■ 25 I	P2.2 ■ 22 G	P2.3 ■ 19 E	P3.1 ■ 15 G	P3.2 ■ 12 G	P3.3 ■ 10 E	P4.1 ■ 9 G	P4.2 ■ 7 E	P4.3 ■ 6 C	M1.1 ■ 22 G	M1.2 ■ 19 G
M2.1 ■ 20 G	M2.2 ■ 16 G	M3.1 ■ 10 I	M3.2 ■ 9 I	M3.3 ■ 8 I	M4.1 ■ 12 E	K1.1 ■ 30 G	K1.2 ■ 22 E	K1.3 ■ 17 E	K2.1 ■ 23 E	K2.2 ■ 19 E	K2.3 ■ 15 E	K3.1 ■ 21 E	K3.2 ■ 16 E
K3.3 ■ 13 E	K4.1 ■ 19 E	K4.2 ■ 14 E	K4.3 ■ 11 E	K4.4 ■ 9 E	K4.5 ■ 8 E	K5.1 ■ 22 E	K5.2 ■ 16 E	K5.3 ■ 13 E	N1.1 ■ 45 G	N1.2 ■ 34 G	N1.3 ■ 23 G	N2.1 ■ 42 G	N2.2 ■ 37 G
N2.3 ■ 27 G	N3.1 ■ 68 G	N3.2 ■ 40 G	N3.3 ■ 20 G	N4.1 ■ 30 I	S1.1 ■ 27 G	S1.2 ■ 16 E	S1.3 ■ 8 C	S2.1 ■ 11 G	S2.2 ■ 6 C	S3.1 ■ 8 G	S3.2 ■ 4 C	S4.1 ■ 6 G	S4.2 ■ 3 C

Product	TDZ	DC	DC	LCF	OAL	SDL_1	DCON MS
		(mm)	(inch)				
A413M3	M3	3.40	0.1339	28.0	66.0	9.00	6.00
A413M4	M4	4.50	0.1772	37.0	79.0	11.00	8.00
A413M5	M5	5.50	0.2165	43.0	89.0	13.00	10.00
A413M6	M6	6.60	0.2598	47.0	95.0	15.00	11.00
A413M8	M8	9.00	0.3543	56.0	111.0	19.00	15.00
A413M10	M10	11.00	0.4331	62.0	123.0	23.00	18.00

A412



Broca HSS Escalonada, Acabado Templado al Vapor

Diseñada para producir agujeros avellanados para tornillos métricos estándar. Punta a 118° y chaflán a 90°. El acabado templado al vapor actúa reteniendo el fluido de corte y evitando que la viruta se suelde a la herramienta. Adecuada para taladrar la mayoría de materiales. Adecuada para máquinas convencionales y CNC.

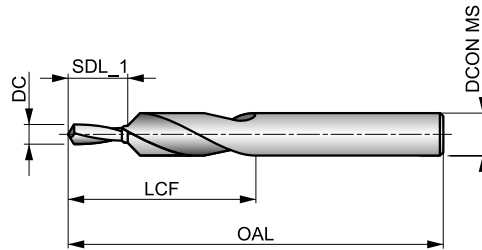

HSS		2.5xD
90°		
R	118°	

Grupo de Material de la pieza adecuado y condiciones de velocidad de corte iniciales (m/min) y código de avance alfabético. Tablas con avance por revolución a partir de la pag.274.

P1.1 ■ 29 I	P1.2 ■ 33 I	P1.3 ■ 34 I	P2.1 ■ 25 I	P2.2 ■ 22 G	P2.3 ■ 19 E	P3.1 ■ 15 G	P3.2 ■ 12 G	P3.3 ■ 10 E	P4.1 ■ 9 G	P4.2 ■ 7 E	P4.3 ■ 6 C	M1.1 ■ 22 G	M1.2 ■ 19 G
M2.1 ■ 20 G	M2.2 ■ 16 G	M3.1 ■ 10 I	M3.2 ■ 9 I	M3.3 ■ 8 I	M4.1 ■ 12 E	K1.1 ■ 30 G	K1.2 ■ 22 E	K1.3 ■ 17 E	K2.1 ■ 23 E	K2.2 ■ 19 E	K2.3 ■ 15 E	K3.1 ■ 21 E	K3.2 ■ 16 E
K3.3 ■ 13 E	K4.1 ■ 19 E	K4.2 ■ 14 E	K4.3 ■ 11 E	K4.4 ■ 9 E	K4.5 ■ 8 E	K5.1 ■ 22 E	K5.2 ■ 16 E	K5.3 ■ 13 E	N1.1 ■ 45 G	N1.2 ■ 34 G	N1.3 ■ 23 G	N2.1 ■ 42 G	N2.2 ■ 37 G
N2.3 ■ 27 G	N3.1 ■ 68 G	N3.2 ■ 40 G	N3.3 ■ 20 G	N4.1 ■ 30 I	S1.1 ■ 27 G	S1.2 ■ 16 E	S1.3 ■ 8 C	S2.1 ■ 11 G	S2.2 ■ 6 C	S3.1 ■ 8 G	S3.2 ■ 4 C	S4.1 ■ 6 G	S4.2 ■ 3 C

Product	TDZ	DC	DC	LCF	OAL	SDL_1	DCON MS
		(mm)	(inch)				
A412M3	M3	3.40	0.1339	31.0	70.0	9.00	6.60
A412M4	M4	4.50	0.1772	40.0	84.0	11.00	9.00
A412M5	M5	5.50	0.2165	47.0	95.0	13.00	11.00
A412M6	M6	6.60	0.2598	51.0	102.0	15.00	13.00
A412M8	M8	9.00	0.3543	62.0	123.0	19.00	17.20
A412M10	M10	11.00	0.4331	70.0	141.0	23.00	21.50

Código de Material (BMC)	HSS	HSS	HSS-E	HSS-E	HSS	HSS	HSS	HSS-E	HM	HSS
Grupo básico estándar (BSG)	DIN 333A	DIN 333A	DIN 333A	DIN 333A	DIN 333R	DORMER	BS 328	DORMER	DIN 333A	
Longitud Útil (ULDR)	1xD	1xD	1xD	1xD	1xD	1xD	1xD	1xD	1xD	1xD
Ángulo de aplicación	60°	60°	60°	60°	R	60°	60°	60°	60°	60°
Recubrimiento	Bright	TiN	Bright	TiAlN	Bright	Bright	Bright	Bright	Bright	Bright
Mango										
Mano (dirección de corte)	R	R	R	R	R	R	R	R	R	R

Código de Familia de Producto	A200	A205	A206	A266	A210	A201	A225	A242	R200	A296
Gama de diámetros de corte PSF	0.50 - 12.50	1.00 - 5.00	1.00 - 5.00	1.00 - 5.00	0.50 - 8.00	0.63 - 6.00	3/64 - 5/16	1.00 - 5.00	1.00 - 5.00	Set
	148	149	150	151	152	153	154	155	156	156

P	P1	■	■	■	■	■	■	■	■	
	P2	■	■	■	■	■	■	■	■	
	P3	■	■	■	■	■	■	■	■	
	P4	■	■	■	■	■	■	■	■	■
M	M1	■	■	■	■	■	■	■	■	
	M2	■	■	■	■	■	■	■	■	
	M3	■	■	■	■	■	■	■	■	
	M4	■	■	■	■	■	■	■	■	
K	K1	■	■	■	■	■	■	■	■	■
	K2	■	■	■	■	■	■	■	■	■
	K3	■	■	■	■	■	■	■	■	■
	K4	■	■	■	■	■	■	■	■	■
	K5	■	■	■	■	■	■	■	■	■
N	N1	■	■	■	■	■	■	■	■	■
	N2	■	■	■	■	■	■	■	■	■
	N3	■	■	■	■	■	■	■	■	■
	N4	■	■	■	■	■	■	■	■	■
	N5	■	■	■	■	■	■	■	■	■
S	S1	■	■	■	■	■	■	■	■	
	S2	■	■	■	■	■	■	■	■	
	S3	■	■	■	■	■	■	■	■	
	S4	■	■	■	■	■	■	■	■	
H	H1									
	H2									
	H3									
	H4									

A200

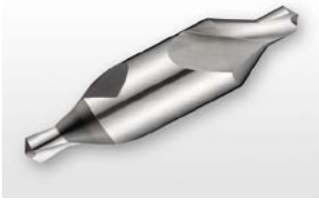

Broca de Centrar HSS con punta a 118° y Chafilán a 60°, Acabado Brillante

Recomendada para iniciar un agujero preciso en el extremo de un eje para poder sujetarlo de forma segura antes del mecanizado. Las puntas a ambos lados aumentan la productividad por herramienta. Adecuada para taladrar la mayoría de materiales.

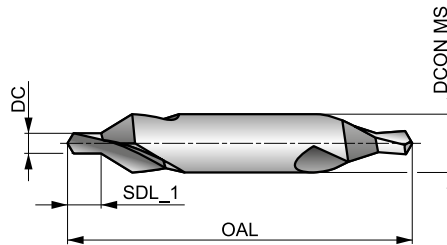

HSS	DIN 333A	1xD
60°	Bright	
R	118°	

Grupo de Material de la pieza adecuado y condiciones de velocidad de corte iniciales (m/min) y código de avance alfabético. Tablas con avance por revolución a partir de la pag.274.

P1.1 ■ 33 I	P1.2 ■ 37 I	P1.3 ■ 38 I	P2.1 ■ 28 I	P2.2 ■ 25 G	P2.3 ■ 22 E	P3.1 ■ 19 F	P3.2 ■ 15 F	P3.3 ■ 13 E	P4.1 ■ 11 F	P4.2 ■ 10 E	P4.3 ■ 8 D	M1.1 ■ 21 E	M1.2 ■ 17 E
M2.1 ■ 18 E	M2.2 ■ 15 E	M3.1 ■ 9 G	M3.2 ■ 8 G	M3.3 ■ 7 G	M4.1 ■ 10 C	K1.1 ■ 30 I	K1.2 ■ 22 F	K1.3 ■ 17 F	K2.1 ■ 25 E	K2.2 ■ 20 E	K2.3 ■ 16 E	K3.1 ■ 22 E	K3.2 ■ 17 E
K3.3 ■ 13 E	K4.1 ■ 20 E	K4.2 ■ 15 E	K4.3 ■ 11 E	K4.4 ■ 10 E	K4.5 ■ 8 E	K5.1 ■ 23 E	K5.2 ■ 17 E	K5.3 ■ 13 E	N1.1 ■ 33 J	N1.2 ■ 25 J	N1.3 ■ 17 I	N2.1 ■ 42 H	N2.2 ■ 37 H
N2.3 ■ 27 H	N3.1 ■ 56 H	N3.2 ■ 33 I	N3.3 ■ 17 G	N4.1 ■ 30 J	N4.2 ■ 28 H	N4.3 ■ 14 F	S1.1 ■ 24 F	S1.2 ■ 13 D	S1.3 ■ 7 B	S2.1 ■ 7 E	S2.2 ■ 6 A	S3.1 ■ 5 E	S3.2 ■ 4 A
S4.1 ■ 4 E	S4.2 ■ 3 A												

Los productos de esta serie también están disponibles en forma de Set. Por favor, vea A296.

Product	DC	DC	SDL_1	OAL	DC ON MS
	(mm)	(inch)			
A200.5X3.15 ¹⁾	0.50	0.0197	0.9 - 0.6	25.0	3.15
A200.8X3.15 ¹⁾	0.80	0.0315	1.3 - 1.0	25.0	3.15
A2001.0X3.15	1.00	0.0394	1.7 - 1.3	31.0	3.15
A2001.25X3.15	1.25	0.0492	2.0 - 1.6	31.0	3.15
A2001.6X4.0	1.60	0.0630	2.6 - 2.0	35.0	4.00
A2002.0X5.0	2.00	0.0787	3.1 - 2.5	40.0	5.00
A2002.5X6.3	2.50	0.0984	3.8 - 3.1	45.0	6.30
A2003.15X8.0	3.15	0.1240	4.6 - 3.9	50.0	8.00
A2004.0X10.0	4.00	0.1575	5.9 - 5.0	55.0	10.00
A2005.0X12.5	5.00	0.1969	7.2 - 6.3	63.0	12.50
A2006.3X16.0	6.30	0.2480	8.9 - 8.0	71.0	16.00
A2008.0X20.0	8.00	0.3150	11.1 - 10.1	80.0	20.00
A20010.0X25.0	10.00	0.3937	13.8 - 12.8	100.0	25.00
A20012.5X31.5	12.50	0.4921	17.5 - 16.5	125.0	31.50

¹⁾ Una sola punta

A205

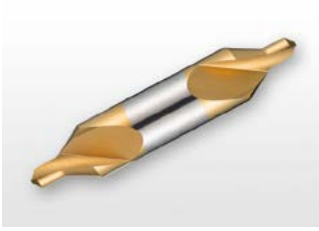

Broca de Centrar HSS con Punta a 118° y Chaflán a 60°, Recubrimiento TiN

Recomendada para iniciar un agujero preciso en el extremo de un eje para poder sujetarlo de forma segura antes del mecanizado. Las puntas a ambos lados aumentan la productividad por herramienta. El recubrimiento TiN mejora el rendimiento y prolonga la vida útil de la herramienta. Adecuada para taladrar la mayoría de materiales.

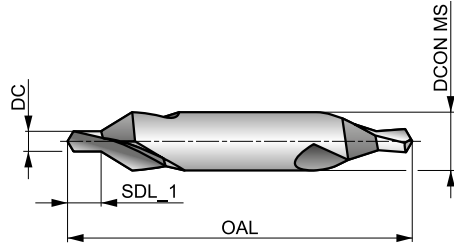

HSS	DIN 333A	1xD
60°	TiN	
R	118°	

Grupo de Material de la pieza adecuado y condiciones de velocidad de corte iniciales (m/min) y código de avance alfabético. Tablas con avance por revolución a partir de la pag.274.

P1.1 ■ 40 I	P1.2 ■ 45 I	P1.3 ■ 46 I	P2.1 ■ 34 I	P2.2 ■ 30 G	P2.3 ▣ 27 E	P3.1 ■ 24 F	P3.2 ■ 19 F	P3.3 ▣ 16 E	P4.1 ■ 14 F	P4.2 ▣ 12 E	P4.3 ▣ 10 D	M1.1 ▣ 25 E	M1.2 ▣ 21 E
M2.1 ▣ 22 E	M2.2 ▣ 18 E	M3.1 ▣ 12 G	M3.2 ▣ 10 G	M3.3 ▣ 9 G	M4.1 ▣ 12 C	K1.1 ■ 36 I	K1.2 ■ 27 F	K1.3 ■ 20 F	K2.1 ▣ 30 E	K2.2 ▣ 24 E	K2.3 ▣ 19 E	K3.1 ▣ 26 E	K3.2 ▣ 20 E
K3.3 ▣ 16 E	K4.1 ▣ 24 E	K4.2 ▣ 18 E	K4.3 ▣ 13 E	K4.4 ▣ 11 E	K4.5 ▣ 10 E	K5.1 ▣ 27 E	K5.2 ▣ 21 E	K5.3 ▣ 16 E	N1.1 ▣ 40 J	N1.2 ▣ 30 J	N1.3 ▣ 20 I	N2.1 ▣ 49 H	N2.2 ▣ 44 H
N2.3 ▣ 32 H	N3.1 ▣ 68 H	N3.2 ▣ 40 I	N3.3 ▣ 20 G	N4.1 ▣ 36 J	N4.2 ▣ 34 H	N4.3 ▣ 17 F	S1.1 ▣ 29 F	S1.2 ▣ 16 D	S1.3 ▣ 8 B	S2.1 ▣ 8 E	S2.2 ▣ 7 A	S3.1 ▣ 16 E	S3.2 ▣ 5 A
S4.1 ▣ 5 E	S4.2 ▣ 4 A												

Product	DC	DC	SDL_1	OAL	DCON MS
	(mm)	(inch)			
A2051.0X3.15	1.00	0.0394	1.7 - 1.3	31.0	3.15
A2051.25X3.15	1.25	0.0492	2.0 - 1.6	31.0	3.15
A2051.6X4.0	1.60	0.0630	2.6 - 2.0	35.0	4.00
A2052.0X5.0	2.00	0.0787	3.1 - 2.5	40.0	5.00
A2052.5X6.3	2.50	0.0984	3.8 - 3.1	45.0	6.30
A2053.15X8.0	3.15	0.1240	4.6 - 3.9	50.0	8.00
A2054.0X10.0	4.00	0.1575	5.9 - 5.0	55.0	10.00
A2055.0X12.5	5.00	0.1969	7.2 - 6.3	63.0	12.50

A206

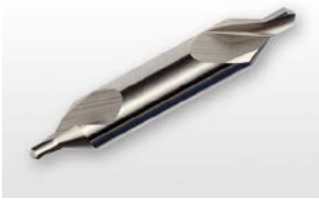

Broca de Centrar HSS con punta a 118° y Chafilán a 60°, Acabado Brillante

Recomendada para iniciar un agujero preciso en el extremo de un eje para poder sujetarlo de forma segura antes del mecanizado. Las puntas a ambos lados aumentan la productividad por herramienta. Adecuada para taladrar la mayoría de materiales.

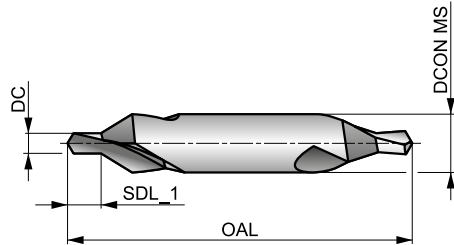

HSS-E	DIN 333A	1xD
60°	Bright	
R	118°	

Grupo de Material de la pieza adecuado y condiciones de velocidad de corte iniciales (m/min) y código de avance alfabético. Tablas con avance por revolución a partir de la pag.274.

P1.1 ■ 40 I	P1.2 ■ 45 I	P1.3 ■ 46 I	P2.1 ■ 34 I	P2.2 ■ 30 G	P2.3 ■ 27 E	P3.1 ■ 24 F	P3.2 ■ 19 F	P3.3 ■ 16 E	P4.1 ■ 14 F	P4.2 ■ 12 E	P4.3 ■ 10 D	M1.1 ■ 25 E	M1.2 ■ 21 E
M2.1 ■ 22 E	M2.2 ■ 18 E	M3.1 ■ 12 G	M3.2 ■ 10 G	M3.3 ■ 9 G	M4.1 ■ 12 C	K1.1 ■ 36 I	K1.2 ■ 27 F	K1.3 ■ 20 F	K2.1 ■ 30 E	K2.2 ■ 24 E	K2.3 ■ 19 E	K3.1 ■ 26 E	K3.2 ■ 20 E
K3.3 ■ 16 E	K4.1 ■ 24 E	K4.2 ■ 18 E	K4.3 ■ 13 E	K4.4 ■ 11 E	K4.5 ■ 10 E	K5.1 ■ 27 E	K5.2 ■ 21 E	K5.3 ■ 16 E	N1.1 ■ 40 J	N1.2 ■ 30 J	N1.3 ■ 20 I	N2.1 ■ 49 H	N2.2 ■ 44 H
N2.3 ■ 32 H	N3.1 ■ 68 H	N3.2 ■ 40 I	N3.3 ■ 20 G	N4.1 ■ 36 J	N4.2 ■ 34 H	N4.3 ■ 17 F	S1.1 ■ 29 F	S1.2 ■ 16 D	S1.3 ■ 8 B	S2.1 ■ 8 E	S2.2 ■ 7 A	S3.1 ■ 6 E	S3.2 ■ 5 A
S4.1 ■ 5 E	S4.2 ■ 4 A												

Product	DC	DC	SDL_1	OAL	DCON MS
	(mm)	(inch)			
A2061.0X3.15	1.00	0.0394	1.7 - 1.3	31.0	3.15
A2061.25X3.15	1.25	0.0492	2.0 - 1.6	31.0	3.15
A2061.6X4.0	1.60	0.0630	2.6 - 2.0	35.0	4.00
A2062.0X5.0	2.00	0.0787	3.1 - 2.5	40.0	5.00
A2062.5X6.3	2.50	0.0984	3.8 - 3.1	45.0	6.30
A2063.15X8.0	3.15	0.1240	4.6 - 3.9	50.0	8.00
A2064.0X10.0	4.00	0.1575	5.9 - 5.0	55.0	10.00
A2065.0X12.5	5.00	0.1969	7.2 - 6.3	63.0	12.50

A266



Broca de Centrar HSS-E con Guía Piloto a 118° y Chafilán a 60°, Recubrimiento TiAlN

Recomendada para iniciar un agujero preciso en el extremo de un eje para poder sujetarlo de forma segura antes del mecanizado. Las puntas a ambos lados aumentan la productividad por herramienta. El recubrimiento TiAlN mejora el rendimiento y prolonga la vida útil de la herramienta. Adecuada para taladrar la mayoría de materiales.

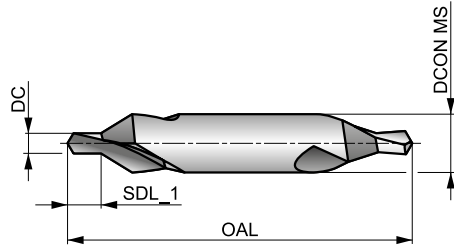

HSS-E	DIN 333A	1xD
60°	TiAlN	
R	118°	

Grupo de Material de la pieza adecuado y condiciones de velocidad de corte iniciales (m/min) y código de avance alfabético. Tablas con avance por revolución a partir de la pag.274.

P1.1 ■ 40 I	P1.2 ■ 45 I	P1.3 ■ 46 I	P2.1 ■ 34 I	P2.2 ■ 30 G	P2.3 ▣ 27 E	P3.1 ■ 24 F	P3.2 ■ 19 F	P3.3 ▣ 16 E	P4.1 ■ 14 F	P4.2 ▣ 12 E	P4.3 ▣ 10 D	M1.1 ▣ 25 E	M1.2 ▣ 21 E
M2.1 ▣ 22 E	M2.2 ▣ 18 E	M3.1 ▣ 12 G	M3.2 ▣ 10 G	M3.3 ▣ 9 G	M4.1 ▣ 12 C	K1.1 ■ 36 I	K1.2 ■ 27 F	K1.3 ■ 20 F	K2.1 ▣ 30 E	K2.2 ▣ 24 E	K2.3 ▣ 19 E	K3.1 ▣ 26 E	K3.2 ▣ 20 E
K3.3 ▣ 16 E	K4.1 ▣ 24 E	K4.2 ▣ 18 E	K4.3 ▣ 13 E	K4.4 ▣ 11 E	K4.5 ▣ 10 E	K5.1 ▣ 27 E	K5.2 ▣ 21 E	K5.3 ▣ 16 E	N1.1 ▣ 40 J	N1.2 ▣ 30 J	N1.3 ▣ 20 I	N2.1 ▣ 49 H	N2.2 ▣ 44 H
N2.3 ▣ 32 H	N3.1 ▣ 68 H	N3.2 ▣ 40 I	N3.3 ▣ 20 G	N4.1 ▣ 36 J	N4.2 ▣ 34 H	N4.3 ▣ 17 F	S1.1 ▣ 29 F	S1.2 ▣ 16 D	S1.3 ▣ 8 B	S2.1 ▣ 8 E	S2.2 ▣ 7 A	S3.1 ▣ 16 E	S3.2 ▣ 5 A
S4.1 ▣ 5 E	S4.2 ▣ 4 A												

Product	DC	DC	SDL_1	OAL	DCON MS
	(mm)	(inch)			
A2661.0X3.15	1.00	0.0394	1.7 - 1.3	31.0	3.15
A2661.25X3.15	1.25	0.0492	2.0 - 1.6	31.0	3.15
A2661.6X4.0	1.60	0.0630	2.6 - 2.0	35.0	4.00
A2662.0X5.0	2.00	0.0787	3.1 - 2.5	40.0	5.00
A2662.5X6.3	2.50	0.0984	3.8 - 3.1	45.0	6.30
A2663.15X8.0	3.15	0.1240	4.6 - 3.9	50.0	8.00
A2664.0X10.0	4.00	0.1575	5.9 - 5.0	55.0	10.00
A2665.0X12.5	5.00	0.1969	7.2 - 6.3	63.0	12.50

A210

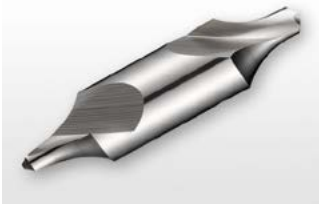

Broca de Centrar HSS con punta a 118° y Chafán Cóncavo, Acabado Brillante

Recomendada para iniciar un agujero preciso en el extremo de un eje para poder sujetarlo de forma segura antes del mecanizado. Las puntas a ambos lados aumentan la productividad por herramienta. Adecuada para taladrar la mayoría de materiales.

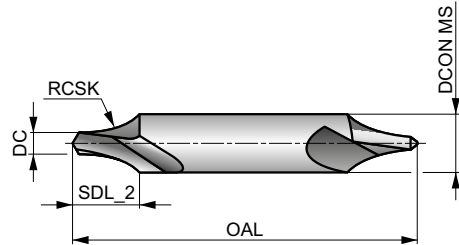

HSS	DIN 333R	1xD
R	Bright	
R	118°	

Grupo de Material de la pieza adecuado y condiciones de velocidad de corte iniciales (m/min) y código de avance alfabético. Tablas con avance por revolución a partir de la pag.274.

P1.1 ■ 33 I	P1.2 ■ 37 I	P1.3 ■ 38 I	P2.1 ■ 28 I	P2.2 ■ 25 G	P2.3 ■ 22 E	P3.1 ■ 19 F	P3.2 ■ 15 F	P3.3 ■ 13 E	P4.1 ■ 11 F	P4.2 ■ 10 E	P4.3 ■ 8 D	M1.1 ■ 21 E	M1.2 ■ 17 E
M2.1 ■ 18 E	M2.2 ■ 15 E	M3.1 ■ 9 G	M3.2 ■ 8 G	M3.3 ■ 7 G	M4.1 ■ 10 C	K1.1 ■ 30 I	K1.2 ■ 22 F	K1.3 ■ 17 F	K2.1 ■ 25 E	K2.2 ■ 20 E	K2.3 ■ 16 E	K3.1 ■ 22 E	K3.2 ■ 17 E
K3.3 ■ 13 E	K4.1 ■ 20 E	K4.2 ■ 15 E	K4.3 ■ 11 E	K4.4 ■ 10 E	K4.5 ■ 8 E	K5.1 ■ 23 E	K5.2 ■ 17 E	K5.3 ■ 13 E	N1.1 ■ 33 J	N1.2 ■ 25 J	N1.3 ■ 17 I	N2.1 ■ 42 H	N2.2 ■ 37 H
N2.3 ■ 27 H	N3.1 ■ 56 H	N3.2 ■ 33 I	N3.3 ■ 17 G	N4.1 ■ 30 J	N4.2 ■ 28 H	N4.3 ■ 14 F	S1.1 ■ 24 F	S1.2 ■ 13 D	S1.3 ■ 7 B	S2.1 ■ 7 E	S2.2 ■ 6 A	S3.1 ■ 5 E	S3.2 ■ 4 A
S4.1 ■ 4 E	S4.2 ■ 3 A												

Product	DC	DC	SDL_2	OAL	RCSK	D CON MS
	(mm)	(inch)	(mm)	(mm)	(mm)	(mm)
A210.5X3.15 ¹⁾	0.50	0.0197	2.6 - 2.3	25.0	2.50 - 2.00	3.15
A210.8X3.15 ¹⁾	0.80	0.0315	2.9 - 2.6	25.0	3.15 - 2.50	3.15
A2101.0X3.15	1.00	0.0394	3.3 - 3.0	31.0	3.65 - 2.90	3.15
A2101.25X3.15	1.25	0.0492	3.6 - 3.3	31.0	3.95 - 3.15	3.15
A2101.6X4.0	1.60	0.0630	4.7 - 4.2	35.0	5.00 - 4.00	4.00
A2102.0X5.0	2.00	0.0787	5.4 - 5.0	40.0	6.25 - 5.00	5.00
A2102.5X6.3	2.50	0.0984	6.8 - 6.3	45.0	7.88 - 6.30	6.30
A2103.15X8.0	3.15	0.1240	8.5 - 8.0	50.0	10.00 - 8.00	8.00
A2104.0X10.0	4.00	0.1575	10.6 - 10.0	55.0	12.50 - 10.00	10.00
A2105.0X12.5	5.00	0.1969	13.1 - 12.5	63.0	15.63 - 12.50	12.50
A2106.3X16.0	6.30	0.2480	16.6 - 16.0	71.0	20.00 - 16.00	16.00
A2108.0X20.0	8.00	0.3150	20.7 - 20.0	80.0	25.00 - 20.00	20.00

¹⁾ Una sola punta

A201



Broca de Centrar HSS con punta a 122° y Chafilán a 60°, Acabado Brillante

Recomendada para iniciar un agujero preciso en el extremo de un eje para poder sujetarlo de forma segura antes del mecanizado. Las puntas a ambos lados aumentan la productividad por herramienta. Adecuada para taladrar la mayoría de materiales.

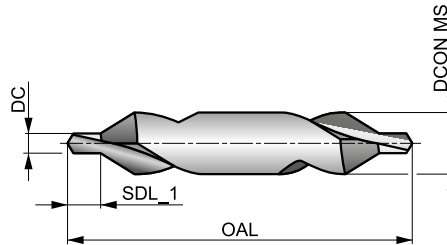

HSS	DORMER	1xD
60°	Bright	
R	122°	

Grupo de Material de la pieza adecuado y condiciones de velocidad de corte iniciales (m/min) y código de avance alfabético. Tablas con avance por revolución a partir de la pag.274.

P1.1 ■ 33 I	P1.2 ■ 37 I	P1.3 ■ 38 I	P2.1 ■ 28 I	P2.2 ■ 25 G	P2.3 ■ 22 E	P3.1 ■ 19 F	P3.2 ■ 15 F	P3.3 ■ 13 E	P4.1 ■ 11 F	P4.2 ■ 10 E	P4.3 ■ 8 D	M1.1 ■ 21 E	M1.2 ■ 17 E
M2.1 ■ 18 E	M2.2 ■ 15 E	M3.1 ■ 19 G	M3.2 ■ 8 G	M3.3 ■ 7 G	M4.1 ■ 10 C	K1.1 ■ 30 I	K1.2 ■ 22 F	K1.3 ■ 17 F	K2.1 ■ 25 E	K2.2 ■ 20 E	K2.3 ■ 16 E	K3.1 ■ 22 E	K3.2 ■ 17 E
K3.3 ■ 13 E	K4.1 ■ 20 E	K4.2 ■ 15 E	K4.3 ■ 11 E	K4.4 ■ 10 E	K4.5 ■ 8 E	K5.1 ■ 23 E	K5.2 ■ 17 E	K5.3 ■ 13 E	N1.1 ■ 33 J	N1.2 ■ 25 J	N1.3 ■ 17 I	N2.1 ■ 42 H	N2.2 ■ 37 H
N2.3 ■ 27 H	N3.1 ■ 56 H	N3.2 ■ 33 I	N3.3 ■ 17 G	N4.1 ■ 30 J	N4.2 ■ 28 H	N4.3 ■ 14 F	S1.1 ■ 24 F	S1.2 ■ 13 D	S1.3 ■ 7 B	S2.1 ■ 7 E	S2.2 ■ 6 A	S3.1 ■ 5 E	S3.2 ■ 4 A
S4.1 ■ 4 E	S4.2 ■ 3 A												

Product	DC	DC	SDL_1	OAL	DC ON MS
	(mm)	(inch)			
A201.63X3.15 ¹⁾	0.63	0.0248	1.2 - 0.9	20.0	3.15
A201.75X3.5	0.75	0.0295	1.3 - 1.0	35.0	3.50
A2011.0X4.0	1.00	0.0394	2.1 - 1.5	35.0	4.00
A2011.5X5.0	1.50	0.0591	2.8 - 2.0	40.0	5.00
A2011.6X5.0	1.60	0.0630	2.4 - 2.0	40.0	5.00
A2012.0X6.0	2.00	0.0787	4.0 - 3.0	45.0	6.00
A2012.0X6.3	2.00	0.0787	2.9 - 2.5	45.0	6.30
A2012.5X8.0	2.50	0.0984	4.5 - 3.5	50.0	8.00
A2013.0X8.0	3.00	0.1181	4.4 - 3.9	50.0	8.00
A2013.0X10.0	3.00	0.1181	5.0 - 4.0	56.0	10.00
A2013.15X10.0	3.15	0.1240	4.4 - 3.9	56.0	10.00
A2014.0X12.0	4.00	0.1575	6.2 - 5.0	66.0	12.00
A2015.0X14.0	5.00	0.1969	7.7 - 6.5	78.0	14.00
A2016.0X18.0	6.00	0.2362	9.2 - 8.0	90.0	18.00

¹⁾ Una sola punta

A225

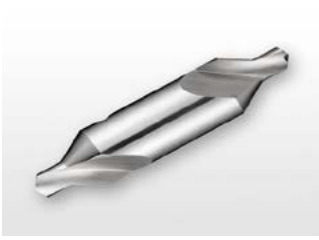

Broca de Centrar HSS, Ángulo de la punta a 120° y chafilán a 60°, Acabado Brillante

Recomendada para iniciar un agujero preciso en el extremo de un eje para poder sujetarlo de forma segura antes del mecanizado. Norma British Standard 328. Las puntas a ambos lados aumentan la productividad por herramienta. Adecuada para taladrar la mayoría de materiales.

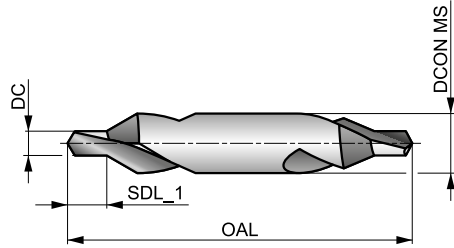

HSS	BS 328	1xD
60°	Bright	
R	120°	

Grupo de Material de la pieza adecuado y condiciones de velocidad de corte iniciales (m/min) y código de avance alfabético. Tablas con avance por revolución a partir de la pag.274.

P1.1 ■ 33 I	P1.2 ■ 37 I	P1.3 ■ 38 I	P2.1 ■ 28 I	P2.2 ■ 25 G	P2.3 ■ 22 E	P3.1 ■ 19 F	P3.2 ■ 15 F	P3.3 ■ 13 E	P4.1 ■ 11 F	P4.2 ■ 10 E	P4.3 ■ 8 D	M1.1 ■ 21 E	M1.2 ■ 17 E
M2.1 ■ 18 E	M2.2 ■ 15 E	M3.1 ■ 19 G	M3.2 ■ 8 G	M3.3 ■ 7 G	M4.1 ■ 10 C	K1.1 ■ 30 I	K1.2 ■ 22 F	K1.3 ■ 17 F	K2.1 ■ 25 E	K2.2 ■ 20 E	K2.3 ■ 16 E	K3.1 ■ 22 E	K3.2 ■ 17 E
K3.3 ■ 13 E	K4.1 ■ 20 E	K4.2 ■ 15 E	K4.3 ■ 11 E	K4.4 ■ 10 E	K4.5 ■ 8 E	K5.1 ■ 23 E	K5.2 ■ 17 E	K5.3 ■ 13 E	N1.1 ■ 33 J	N1.2 ■ 25 J	N1.3 ■ 17 I	N2.1 ■ 42 H	N2.2 ■ 37 H
N2.3 ■ 27 H	N3.1 ■ 56 H	N3.2 ■ 33 I	N3.3 ■ 17 G	N4.1 ■ 30 J	N4.2 ■ 28 H	N4.3 ■ 14 F	S1.1 ■ 24 F	S1.2 ■ 13 D	S1.3 ■ 7 B	S2.1 ■ 7 E	S2.2 ■ 6 A	S3.1 ■ 5 E	S3.2 ■ 4 A
S4.1 ■ 4 E	S4.2 ■ 3 A												

Los productos de esta serie también están disponibles en forma de Set. Por favor, vea A296.

Product	Nr.	DC (inch)	DC (inch)	SDL_1 (inch)	OAL (inch)	DCON MS (inch)
A225BS1	BS1	3/64	0.0469	5/64 - 1/16	1.1/2	1/8
A225BS2	BS2	1/16	0.0625	3/32 - 5/64	1.3/4	3/16
A225BS3	BS3	3/32	0.0938	5/32 - 1/8	2"	1/4
A225BS4	BS4	1/8	0.1250	3/16 - 5/32	2.1/4	5/16
A225BS5	BS5	3/16	0.1875	9/32 - 1/4	2.1/2	7/16
A225BS5A	BS5A	7/32	0.2188	5/16 - 9/32	2.3/4	1/2
A225BS6	BS6	1/4	0.2500	3/8 - 5/16	3"	5/8
A225BS7	BS7	5/16	0.3125	15/32 - 13/32	3.1/2	3/4

A242



Broca de Centrar Larga HSS-E (5% Cobalto), Chafilán a 60°, Punta a 118°, Acabado Brillante

Diseñada para iniciar un agujero preciso en el extremo de un eje para poder sujetarlo de forma segura antes del mecanizado. Las puntas a ambos lados aumentan la productividad por herramienta. Adecuada para taladrar la mayoría de materiales.

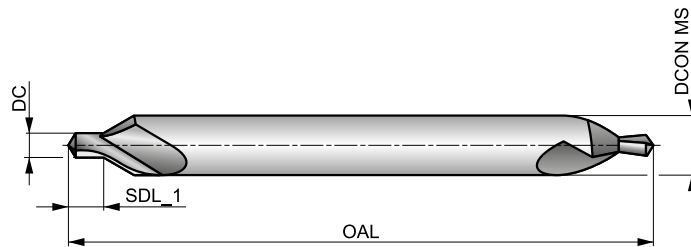

HSS-E		1xD
60°	Bright	
R	118°	

Grupo de Material de la pieza adecuado y condiciones de velocidad de corte iniciales (m/min) y código de avance alfabético. Tablas con avance por revolución a partir de la pag.274.

P1.1 ■ 33 I	P1.2 ■ 37 I	P1.3 ■ 38 I	P2.1 ■ 28 I	P2.2 ■ 25 G	P2.3 ■ 22 E	P3.1 ■ 19 F	P3.2 ■ 15 F	P3.3 ■ 13 E	P4.1 ■ 11 F	P4.2 ■ 10 E	P4.3 ■ 8 D	M1.1 ■ 21 E	M1.2 ■ 17 E
M2.1 ■ 18 E	M2.2 ■ 15 E	M3.1 ■ 19 G	M3.2 ■ 8 G	M3.3 ■ 7 G	M4.1 ■ 10 C	K1.1 ■ 30 I	K1.2 ■ 22 F	K1.3 ■ 17 F	K2.1 ■ 25 E	K2.2 ■ 20 E	K2.3 ■ 16 E	K3.1 ■ 22 E	K3.2 ■ 17 E
K3.3 ■ 13 E	K4.1 ■ 20 E	K4.2 ■ 15 E	K4.3 ■ 11 E	K4.4 ■ 10 E	K4.5 ■ 8 E	K5.1 ■ 23 E	K5.2 ■ 17 E	K5.3 ■ 13 E	N1.1 ■ 33 J	N1.2 ■ 25 J	N1.3 ■ 17 I	N2.1 ■ 42 H	N2.2 ■ 37 H
N2.3 ■ 27 H	N3.1 ■ 56 H	N3.2 ■ 33 I	N3.3 ■ 17 G	N4.1 ■ 30 J	N4.2 ■ 28 H	N4.3 ■ 14 F	S1.1 ■ 24 F	S1.2 ■ 13 D	S1.3 ■ 7 B	S2.1 ■ 7 E	S2.2 ■ 6 A	S3.1 ■ 5 E	S3.2 ■ 4 A
S4.1 ■ 4 E	S4.2 ■ 3 A												

Product	DC	DC	SDL_1	OAL	DCON MS
	(mm)	(inch)			
A2421.0X4.0	1.00	0.0394	1.7 - 1.3	100.0	4.00
A2421.5X5.0	1.50	0.0591	2.6 - 2.0	100.0	5.00
A2422.0X6.0	2.00	0.0787	3.1 - 2.5	100.0	6.00
A2422.5X8.0	2.50	0.0984	3.8 - 3.1	100.0	8.00
A2423.0X8.0	3.00	0.1181	4.6 - 3.9	100.0	8.00
A2423.0X10.0	3.00	0.1181	4.6 - 3.9	100.0	10.00
A2424.0X10.0	4.00	0.1575	5.9 - 5.0	100.0	10.00
A2424.0X12.0	4.00	0.1575	5.9 - 5.0	100.0	12.00
A2425.0X12.0	5.00	0.1969	7.2 - 6.3	100.0	12.00

R200

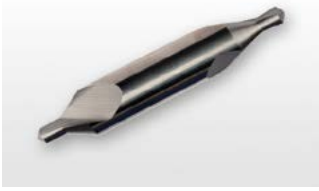

Broca Metal Duro con punta a 118° y Chafilán a 60°, Acabado Brillante

Recomendada para iniciar un agujero preciso en el extremo de un eje para poder sujetarlo de forma segura antes del mecanizado. Adecuada para taladrar la mayoría de materiales. Las puntas a ambos lados aumentan la productividad por herramienta. Punta a 118° y avellanador a 60°. Adecuada para todas las máquinas CNC.

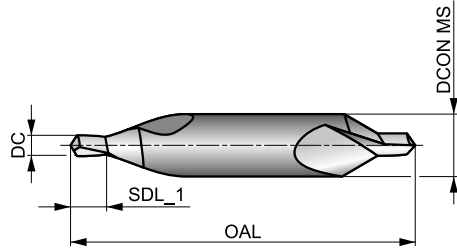

HM	DIN 333A	1xD
60°	Bright	
R		

Grupo de Material de la pieza adecuado y condiciones de velocidad de corte iniciales (m/min) y código de avance alfabético. Tablas con avance por revolución a partir de la pag.274.

P1.1 ■ 60 H	P1.2 ■ 67 H	P1.3 ■ 69 H	P2.1 ■ 51 H	P2.2 ■ 45 F	P2.3 ■ 40 D	P3.1 ■ 44 E	P3.2 ■ 36 E	P3.3 ■ 30 D	P4.1 ■ 26 E	P4.2 ■ 22 D	P4.3 ■ 18 C	K1.1 ■ 40 H	K1.2 ■ 30 E
K1.3 ■ 22 E	K2.1 ■ 37 D	K2.2 ■ 30 D	K2.3 ■ 24 D	K3.1 ■ 33 D	K3.2 ■ 25 D	K3.3 ■ 20 D	K4.1 ■ 30 D	K4.2 ■ 23 D	K4.3 ■ 17 D	K4.4 ■ 14 D	K4.5 ■ 12 D	K5.1 ■ 34 D	K5.2 ■ 26 D
K5.3 ■ 20 D	N1.1 ■ 120 I	N1.2 ■ 90 I	N1.3 ■ 60 H	N2.1 ■ 154 G	N2.2 ■ 138 G	N2.3 ■ 100 G	N3.1 ■ 169 G	N3.2 ■ 100 H	N3.3 ■ 50 F				

Product	DC	DC	SDL_1	OAL	DCON MS
	(mm)	(inch)			
R2001.0X3.15	1.00	0.0394	1.7 - 1.3	31.0	3.15
R2001.25X3.15	1.25	0.0492	2.0 - 1.6	31.0	3.15
R2001.6X4.0	1.60	0.0630	2.6 - 2.0	35.0	4.00
R2002.0X5.0	2.00	0.0787	3.1 - 2.5	40.0	5.00
R2002.5X6.3	2.50	0.0984	3.8 - 3.1	45.0	6.30
R2003.15X8.0	3.15	0.1240	4.6 - 3.9	50.0	8.00
R2004.0X10.0	4.00	0.1575	5.9 - 5.0	55.0	10.00
R2005.0X12.5	5.00	0.1969	7.2 - 6.3	63.0	12.50

A296



Juego de Brocas de Centrar HSS

Un juego de cinco brocas de centrar que vienen en un práctico estuche de plástico para mantener todas las brocas juntas. Recomendadas para iniciar un agujero preciso en el extremo de un eje para poder sujetarlo de forma segura antes del mecanizado. Las puntas a ambos lados aumentan la productividad por herramienta.

A296200 - punta de 118° DIN333A, A296225 - punta de 120° BS328. A=Tipos en el Juego, B=No en el Juego, C=Diámetros en el Juego.

Product	Nr.	A	B	C
A296200	200	A200	5	1.00 mm, 2.00 mm, 2.50 mm, 3.15 mm, 4.00 mm
A296225	225	A225	5	BS1, BS2, BS3, BS4, BS5

Código de Material (BMC)	HSS	HSS-E	HSS	HSS-E	HM	HSS	HSS	HSS	HSS
Recubrimiento	TIN	Bright	TIAIN	AITICN	Bright	TIAIN	Bright	Bright	TIN
Grupo básico estándar (BSG)	DIN 334C	DORNER	DIN 335C	DIN 335C	DIN 335C	DIN 335C	DIN 334D	DIN 335D	DIN 335D
Mano (dirección de corte)	R	R	R	R	R	R	R	R	R
Mango									
Ángulo de aplicación	60°	90°	90°	90°	90°	100°	60°	90°	90°



Código de Familia de Producto	G335	G149	G560	G570	G400	G171	G137	G138	G338
Gama de diámetros de corte PSF	6.30 - 25.00	5.00 - 25.00	6.30 - 31.00	6.30 - 31.00	6.30 - 31.00	6.30 - 25.00	31.50 - 50.00	25.00 - 63.00	25.00 - 50.00
	158	159	160	161	162	163	164	165	166

P	P1	■	■	■	▣	■	■	■	■
	P2	■	■	■	▣	■	■	■	■
	P3	■	■	■	■	■	▣	▣	■
	P4	■	■	■	■	■	▣	▣	■
M	M1	▣	▣	▣	■	▣	▣	▣	▣
	M2	▣	▣	▣	■	▣	▣	▣	▣
	M3	▣	■	■	■	▣	■	■	■
	M4	■	■	▣	▣	▣	■	■	■
K	K1	■	▣	■	■	■	▣	▣	■
	K2	■	▣	■	■	■	▣	▣	■
	K3	■	▣	■	■	■	▣	▣	■
	K4	▣	■	▣	▣	■	▣	▣	▣
	K5	■	▣	■	■	■	▣	▣	■
N	N1	■	■	▣	▣	■	▣	▣	■
	N2	■	▣	■	▣	■	▣	▣	■
	N3	■	■	■	▣	■	■	■	■
	N4	▣	▣	▣	■	■	▣	▣	▣
	N5	■	■	■	■	■	■	■	■
S	S1	■	■	■	■	■	■	■	■
	S2	■	■	■	■	■	■	■	■
	S3	■	■	■	■	■	■	■	■
	S4	■	■	■	■	■	■	■	■
H	H1	■	■	■	■	■	■	■	■
	H2	■	■	■	■	■	■	■	■
	H3	■	■	■	■	■	■	■	■
	H4	■	■	■	■	■	■	■	■

G335



Avellanador HSS a 60°, Mango Cilíndrico, con Recubrimiento TiN

Para avellanar agujeros biselados a 60° para alojar tornillos especiales y eliminar las rebabas de los agujeros perforados. El recubrimiento de TiN mejora el rendimiento y prolonga la vida útil de la herramienta. Herramienta versátil que se puede utilizar tanto en aplicaciones manuales como en máquinas. Adecuado para biselar agujeros en muchos materiales.

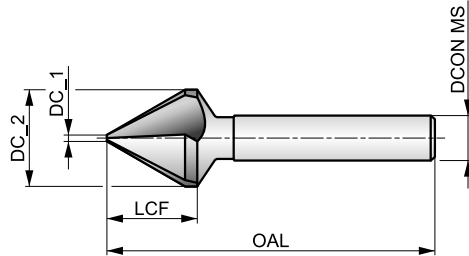

HSS	TiN	DIN 334C
R		60°

Grupo de Material de la pieza adecuado y condiciones de velocidad de corte iniciales (m/min) y código de avance alfabético. Tablas con avance por revolución a partir de la pag.280.

P1.1 ■ 33 E	P1.2 ■ 37 E	P1.3 ■ 38 E	P2.1 ■ 28 E	P2.2 ■ 25 D	P2.3 ■ 22 B	P3.1 ■ 23 D	P3.2 ■ 18 D	P3.3 ■ 15 B	P4.1 ■ 13 D	P4.2 ■ 11 B	P4.3 ▧ 9 B	M1.1 ▧ 10 C	M1.2 ▧ 8 C
M2.1 ▧ 9 C	M3.1 ▧ 8 B	K1.1 ■ 34 F	K1.2 ■ 25 D	K1.3 ▧ 19 D	K2.1 ■ 35 C	K2.2 ■ 28 C	K2.3 ▧ 23 C	K3.1 ■ 31 C	K3.2 ■ 24 C	K3.3 ▧ 19 C	K4.1 ▧ 29 C	K4.2 ▧ 22 C	K4.3 ▧ 16 C
K5.1 ■ 32 C	K5.2 ■ 24 C	K5.3 ▧ 19 C	N1.1 ■ 53 G	N1.2 ■ 40 G	N1.3 ■ 27 F	N2.1 ■ 27 F	N2.2 ■ 24 F	N2.3 ■ 17 F	N3.1 ■ 28 F	N3.2 ■ 16 F	N3.3 ▧ 8 D	N4.1 ▧ 58 G	N4.2 ▧ 50 G

DCON MS tolerancia h9.

Product	DC_2 (mm)	DC_1 (mm)	LCF (mm)	OAL (mm)	DCON MS (mm)	NOF
G3356.3	6.30	1.60	6.8	45.0	5.00	3
G3358.0	8.00	2.00	8.5	50.0	6.00	3
G33510.0	10.00	2.50	7.6	50.0	6.00	3
G33512.5	12.50	3.20	11.7	56.0	8.00	3
G33516.0	16.00	4.00	14.5	63.0	10.00	3
G33520.0	20.00	5.00	17.5	67.0	10.00	3
G33525.0	25.00	6.30	20.5	71.0	10.00	3

G149



Avellanador HSS-E a 90°, con Agujero Pasante, Mango Cilíndrico, con Acabado Brillante

Avellanador de 90° diseñado para achaflanar agujeros y para eliminar rebabas en agujeros taladrados. El diseño especial de agujero cruzado dirige la viruta lejos del filo de corte para ofrecer una operación de achaflanado suave. Adecuado para achaflanar agujeros en la mayoría de materiales.

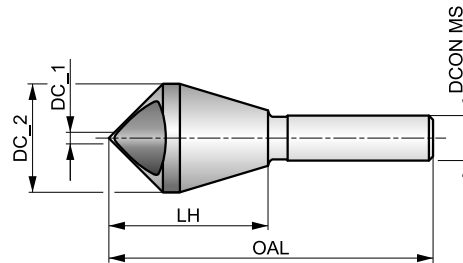

HSS-E	Bright	DORMER
R		90°

Grupo de Material de la pieza adecuado y condiciones de velocidad de corte iniciales (m/min) y código de avance alfabético. Tablas con avance por revolución a partir de la pag.280.

P1.1 ▣21 D	P1.2 ▣24 D	P1.3 ▣25 D	P2.1 ▣18 D	P2.2 ▣16 C	P2.3 ▣14 A	P3.1 ▣16 B	P3.2 ▣13 B	M1.1 ▣8 B	M1.2 ▣6 B	M2.1 ▣7 B	K1.1 ▣18 D	K2.1 ▣19 A	K3.1 ▣16 A
K5.1 ▣14 A	N1.1 ▣34 D	N1.2 ▣25 D	N1.3 ▣16 C	N2.1 ▣16 C	N2.2 ▣14 C	N3.1 ▣17 C	N3.2 ▣9 C	N3.3 ▣5 B	N4.1 ▣17 D	N4.2 ▣5 D			

Product	DC_2 (mm)	DC_1 (mm)	LH (mm)	OAL (mm)	DCON MS (mm)	DC (mm)	NOF
G1495	5.00	2.00	19.0	45.0	6.00	10.00	1
G14910	10.00	5.00	23.0	48.0	8.00	14.00	1
G14915	15.00	10.00	34.0	65.0	10.00	21.00	1
G14920	20.00	15.00	43.0	84.0	12.00	28.00	1
G14925	25.00	20.00	48.0	102.0	15.00	35.00	1

G560



Avellanador HSS a 90°, Mango Cilíndrico, con Recubrimiento TiAIN

Avellanador de 90° diseñado para achaflanar agujeros para tornillos estándar y para eliminar rebabas en agujeros taladrados. El mango reducido permite avellanados de mayor diámetro en portaherramientas y portabrocas estándar. Herramienta versátil, que se puede utilizar en aplicaciones manuales y en máquinas. El recubrimiento TiAIN mejora el rendimiento y prolonga la vida útil de la herramienta.

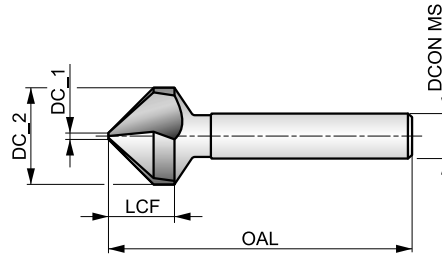

HSS	TiAIN	DIN 335C
R	90°	

Grupo de Material de la pieza adecuado y condiciones de velocidad de corte iniciales (m/min) y código de avance alfabético. Tablas con avance por revolución a partir de la pag.280.

P1.1 ■ 40 E	P1.2 ■ 45 E	P1.3 ■ 46 E	P2.1 ■ 34 E	P2.2 ■ 30 D	P2.3 ■ 27 B	P3.1 ■ 28 D	P3.2 ■ 22 D	P3.3 ■ 19 B	P4.1 ■ 16 D	P4.2 ■ 14 B	P4.3 ■ 11 B	M1.1 ■ 11 C	M1.2 ■ 9 C
M2.1 ■ 10 C	M2.2 ■ 19 C	M2.3 ■ 8 B	K1.1 ■ 41 F	K1.2 ■ 30 D	K1.3 ■ 23 D	K2.1 ■ 42 C	K2.2 ■ 34 C	K2.3 ■ 27 C	K3.1 ■ 37 C	K3.2 ■ 28 C	K3.3 ■ 23 C	K4.1 ■ 34 C	K4.2 ■ 26 C
K4.3 ■ 19 C	K5.1 ■ 39 C	K5.2 ■ 29 C	K5.3 ■ 23 C	N1.1 ■ 60 G	N1.2 ■ 45 G	N1.3 ■ 30 F	N2.1 ■ 30 F	N2.2 ■ 27 F	N2.3 ■ 19 F	N3.1 ■ 32 F	N3.2 ■ 18 F	N3.3 ■ 19 D	N4.1 ■ 62 G
N4.2 ■ 55 G													

DCON MS tolerancia h9.
Los productos de esta serie también están disponibles en forma de Set. Por favor, vea G236.

Product	DC_2 (mm)	DC_1 (mm)	LCF (mm)	OAL (mm)	DCON MS (mm)	NOF
G5606.3	6.30	1.50	5.5	45.0	5.00	3
G5608.0	8.00	2.00	6.1	50.0	6.00	3
G5608.3	8.30	2.00	6.5	50.0	6.00	3
G56010.0	10.00	2.50	7.6	50.0	6.00	3
G56010.4	10.40	2.50	7.6	50.0	6.00	3
G56012.4	12.40	2.80	8.5	56.0	8.00	3
G56016.5	16.50	3.20	10.5	60.0	10.00	3
G56020.5	20.50	3.50	13.0	63.0	10.00	3
G56025.0	25.00	3.80	15.5	67.0	10.00	3
G56031.0	31.00	4.20	18.5	71.0	12.00	3

G570



Avellanador HSS-E a 90°, Mango Cilíndrico, con Recubrimiento AlTiCN

Avellanador de 90° diseñado para achaflanar agujeros para tornillos estándar y para eliminar rebabas en agujeros taladrados. Se puede utilizar en aplicaciones manuales y en máquinas. Especialmente indicado para achaflanar agujeros en materiales duros y abrasivos. El recubrimiento AlTiCN mejora el rendimiento y prolonga la vida útil de la herramienta.

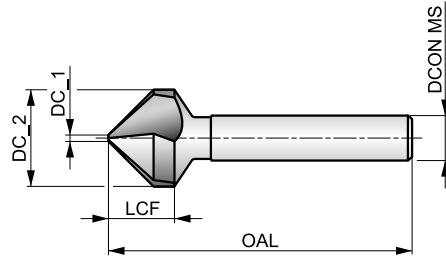

HSS-E	AlTiCN	DIN 335C
R		90°

Grupo de Material de la pieza adecuado y condiciones de velocidad de corte iniciales (m/min) y código de avance alfabético. Tablas con avance por revolución a partir de la pag.280.

P1.1 ■ 40 E	P1.2 ■ 45 E	P1.3 ■ 46 E	P2.1 ■ 34 E	P2.2 ■ 30 D	P2.3 ■ 27 B	P3.1 ■ 28 D	P3.2 ■ 22 D	P3.3 ■ 19 B	P4.1 ■ 16 D	P4.2 ■ 14 B	P4.3 ■ 11 B	M1.1 ■ 23 C	M1.2 ■ 20 C
M2.1 ■ 21 C	M2.2 ■ 17 C	M2.3 ■ 14 A	M3.1 ■ 14 B	M3.2 ■ 12 B	M3.3 ■ 11 B	M4.1 ■ 15 A	M4.2 ■ 13 A	K1.1 ■ 41 C	K1.2 ■ 30 C	K1.3 ■ 23 C	K2.1 ■ 42 C	K2.2 ■ 34 C	K2.3 ■ 27 C
K3.1 ■ 37 C	K3.2 ■ 28 C	K3.3 ■ 23 C	K4.1 ■ 34 C	K4.2 ■ 26 C	K4.3 ■ 19 C	K5.1 ■ 39 C	K5.2 ■ 29 C	K5.3 ■ 23 C	N1.1 ■ 60 G	N1.2 ■ 45 G	N1.3 ■ 30 F	N2.1 ■ 30 F	N2.2 ■ 27 F
N2.3 ■ 19 F	N3.1 ■ 32 F	N3.2 ■ 18 F	N3.3 ■ 9 D										

DCON MS tolerancia h9.

Product	DC_2 (mm)	DC_1 (mm)	LCF (mm)	OAL (mm)	DCON MS (mm)	NOF
G5706.3	6.30	1.50	6.5	45.0	5.00	3
G5708.3	8.30	2.00	8.2	50.0	6.00	3
G57010.4	10.40	2.50	9.7	50.0	6.00	3
G57012.4	12.40	2.80	10.6	56.0	8.00	3
G57016.5	16.50	3.20	13.9	60.0	10.00	3
G57020.5	20.50	3.50	17.1	63.0	10.00	3
G57025.0	25.00	3.80	21.4	67.0	10.00	3
G57031.0	31.00	4.20	24.4	71.0	12.00	3

G400



Avellanador de Metal Duro a 90°, Mango Cilíndrico, Acabado Brillante

Avellanador de alto rendimiento a 90° con acabado brillante, diseñado para uso en máquinas CNC donde se requiere alta productividad y calidad. Puede utilizarse para achaflanar agujeros en materiales duros y abrasivos. El ángulo de 90° está diseñado para avellanar agujeros para tornillos estándar con cabezas de 90°.

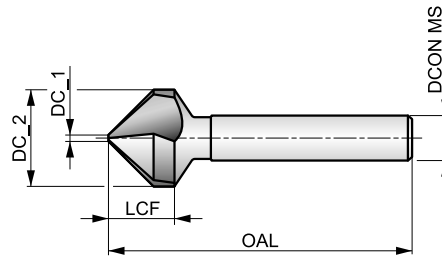

HM	Bright	DIN 335C
R		90°

Grupo de Material de la pieza adecuado y condiciones de velocidad de corte iniciales (m/min) y código de avance alfabético. Tablas con avance por revolución a partir de la pag.280.

P1.1 ■ 64 E	P1.2 ■ 72 E	P1.3 ■ 74 E	P2.1 ■ 55 E	P2.2 ■ 48 D	P2.3 ■ 43 B	P3.1 ■ 45 D	P3.2 ■ 36 D	P3.3 ■ 30 B	P4.1 ■ 26 D	P4.2 ■ 23 B	P4.3 ■ 18 A	M1.1 ■ 24 C	M1.2 ■ 21 C
M2.1 ■ 22 C	M2.2 ▧ 18 C	M2.3 ▧ 15 B	M3.1 ■ 20 B	M3.2 ▧ 17 B	M3.3 ▧ 15 B	M4.1 ▧ 15 A	M4.2 ▧ 13 A	K1.1 ■ 45 F	K1.2 ■ 33 D	K1.3 ■ 25 D	K2.1 ■ 46 C	K2.2 ■ 37 C	K2.3 ▧ 30 C
K3.1 ■ 41 C	K3.2 ■ 31 C	K3.3 ▧ 25 C	K4.1 ■ 38 C	K4.2 ■ 28 C	K4.3 ■ 21 C	K4.4 ▧ 18 C	K4.5 ▧ 15 C	K5.1 ■ 43 C	K5.2 ■ 32 C	K5.3 ■ 25 C	N1.1 ▧ 75 G	N1.2 ■ 55 G	N1.3 ■ 40 F
N2.1 ■ 40 F	N2.2 ■ 36 F	N2.3 ■ 26 F	N3.1 ■ 42 F	N3.2 ■ 25 F	N3.3 ▧ 13 D	N4.3 ■ 17 E	S1.1 ■ 12 C	S1.2 ■ 10 A	S1.3 ▧ 9 A	S2.1 ■ 8 B	S2.2 ▧ 7 A	S3.1 ■ 6 B	S3.2 ▧ 5 A
S4.1 ■ 5 B	S4.2 ▧ 4 A	H1.1 ■ 12 A	H2.1 ■ 7 A	H2.2 ▧ 6 B	H3.1 ■ 8 A	H3.2 ▧ 7 B	H4.1 ■ 5 A	H4.2 ▧ 4 B					

DCON MS tolerancia h6.

Product	DC_2 (mm)	DC_1 (mm)	LCF (mm)	OAL (mm)	DCON MS (mm)	NOF
G4006.3	6.30	1.50	5.0	45.0	5.00	3
G4008.3	8.30	2.00	6.0	50.0	6.00	3
G40010.4	10.40	2.50	7.1	50.0	6.00	3
G40012.4	12.40	2.80	8.0	56.0	8.00	3
G40016.5	16.50	3.20	10.0	60.0	10.00	3
G40020.5	20.50	3.50	12.5	63.0	10.00	3
G40025.0	25.00	3.80	15.0	67.0	10.00	3
G40031.0	31.00	4.20	18.0	71.0	12.00	3

G171



Avellanador HSS a 100°, Mango Cilíndrico, con Recubrimiento TiAlN

Un avellanador a 100° diseñado para achaflanar agujeros estándar y eliminar rebabas. Una herramienta versátil con recubrimiento TiAlN que mejora el rendimiento y aumenta la vida de filo. Se puede utilizar en máquinas automáticas y manuales. Adecuada para achaflanar agujeros en la mayoría de materiales.

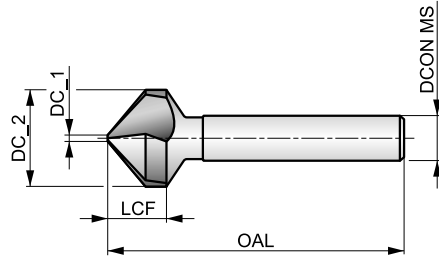

HSS	TiAlN	DIN 335C
R	100°	

Grupo de Material de la pieza adecuado y condiciones de velocidad de corte iniciales (m/min) y código de avance alfabético. Tablas con avance por revolución a partir de la pag.280.

P1.1 ■ 40 E	P1.2 ■ 45 E	P1.3 ■ 46 E	P2.1 ■ 34 E	P2.2 ■ 30 D	P2.3 ■ 27 B	P3.1 ■ 28 D	P3.2 ■ 22 D	P3.3 ■ 19 B	P4.1 ■ 16 D	P4.2 ■ 14 B	P4.3 ■ 11 B	M1.1 ■ 11 C	M1.2 ■ 9 C
M2.1 ■ 10 C	K1.1 ■ 41 F	K1.2 ■ 30 D	K1.3 ■ 23 D	K2.1 ■ 42 C	K2.2 ■ 34 C	K2.3 ■ 27 C	K3.1 ■ 37 C	K3.2 ■ 28 C	K3.3 ■ 23 C	K4.1 ■ 34 C	K4.2 ■ 26 C	K4.3 ■ 19 C	K5.1 ■ 39 C
K5.2 ■ 29 C	K5.3 ■ 23 C	N1.1 ■ 60 G	N1.2 ■ 45 G	N1.3 ■ 30 F	N2.1 ■ 30 F	N2.2 ■ 27 F	N2.3 ■ 19 F	N3.1 ■ 32 F	N3.2 ■ 18 F	N3.3 ■ 9 D	N4.1 ■ 62 G	N4.2 ■ 55 G	

DCON MS tolerancia h9.

Product	DC_2 (mm)	DC_1 (mm)	LCF (mm)	OAL (mm)	DCON MS (mm)	NOF
G1716.3	6.30	1.50	4.5	44.0	5.00	3
G1718.3	8.30	2.00	5.5	49.0	6.00	3
G17110.4	10.40	2.50	6.6	49.0	6.00	3
G17112.4	12.40	2.80	7.0	53.0	8.00	3
G17116.5	16.50	3.20	9.0	56.0	10.00	3
G17120.5	20.50	3.50	11.0	61.0	10.00	3
G17125.0	25.00	3.80	13.5	65.0	10.00	3

G137



Avellanador HSS a 60°, Mango Cónico, Acabado Brillante

Avellanadores con acabado brillante y ángulo de 60° para achaflanar agujeros para tornillos especiales y eliminar rebabas de agujeros taladrados. El diseño de mango cónico permite que la herramienta se pueda fijar directamente en el husillo de la máquina. Adecuado para achaflanar agujeros en muchos materiales.

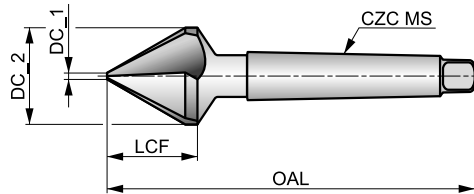

HSS	Bright	DIN 334D
R		60°

Grupo de Material de la pieza adecuado y condiciones de velocidad de corte iniciales (m/min) y código de avance alfabético. Tablas con avance por revolución a partir de la pag.280.

P1.1 ■ 23 E	P1.2 ■ 26 E	P1.3 ■ 27 E	P2.1 ■ 20 E	P2.2 ■ 18 D	P2.3 ▣ 16 B	P3.1 ■ 16 D	P3.2 ▣ 13 D	P3.3 ▣ 11 B	P4.1 ■ 10 D	P4.2 ▣ 8 B	M1.1 ▣ 8 C	M1.2 ▣ 16 C	M2.1 ▣ 17 C
M2.2 ▣ 16 C	K1.1 ▣ 20 F	K1.2 ▣ 15 D	K2.1 ▣ 21 C	K2.2 ▣ 17 C	K3.1 ▣ 18 C	K3.2 ▣ 14 C	K5.1 ▣ 19 C	K5.2 ▣ 15 C	N1.1 ▣ 40 G	N1.2 ■ 30 G	N1.3 ▣ 20 F	N2.1 ■ 20 F	N2.2 ▣ 18 F
N3.1 ■ 21 F	N3.2 ■ 12 F	N3.3 ▣ 16 D	N4.1 ▣ 40 G	N4.2 ▣ 35 G									

Product	DC_2 (mm)	DC_1 (mm)	LCF (mm)	OAL (mm)	CZC MS	NOF
G13731.5	31.50	10.00	23.0	118.0	MK 2	3
G13740.0	40.00	12.50	28.5	150.0	MK 3	3
G13750.0	50.00	16.00	36.0	160.0	MK 3	3

G138

DORMER



Avellanador HSS a 90°, Mango Cónico, con Acabado Brillante

Avellanador de 90° diseñado para achaflanar agujeros para tornillos estándar y para eliminar rebabas en agujeros taladrados. El mango cónico permite que la herramienta se pueda utilizar en aplicaciones de máquinas en las que se sujeta directamente en el husillo. Adecuado para achaflanar agujeros en la mayoría de materiales.

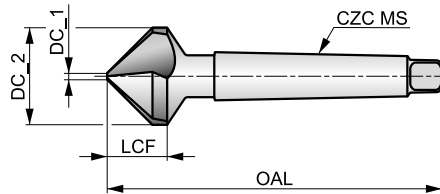

HSS	Bright	DIN 335D
R		90°

Grupo de Material de la pieza adecuado y condiciones de velocidad de corte iniciales (m/min) y código de avance alfabético. Tablas con avance por revolución a partir de la pag.280.

P1.1 ■ 23 E	P1.2 ■ 26 E	P1.3 ■ 27 E	P2.1 ■ 20 E	P2.2 ■ 18 D	P2.3 ▧ 16 B	P3.1 ■ 16 D	P3.2 ▧ 13 D	P3.3 ▧ 11 B	P4.1 ■ 10 D	P4.2 ▧ 8 B	M1.1 ▧ 8	M1.2 ▧ 6	M2.1 ▧ 7
M2.2 ▧ 6	K1.1 ▧ 20 F	K1.2 ▧ 15 D	K2.1 ▧ 21 C	K2.2 ▧ 17 C	K3.1 ▧ 18 C	K3.2 ▧ 14 C	K5.1 ▧ 19 C	K5.2 ▧ 15 C	N1.1 ▧ 40 G	N1.2 ■ 30 G	N1.3 ▧ 20 F	N2.1 ■ 20 F	N2.2 ▧ 18 F
N3.1 ■ 21 F	N3.2 ■ 12 F	N3.3 ▧ 16 D	N4.1 ▧ 40 G	N4.2 ▧ 35 G									

Product	DC_2 (mm)	DC_1 (mm)	LCF (mm)	OAL (mm)	CZC MS	NOF
G13825.0	25.00	3.80	15.5	106.0	MK 2	3
G13830.0	30.00	4.20	18.5	112.0	MK 2	3
G13831.0	31.00	4.20	20.0	112.0	MK 2	3
G13834.0	34.00	4.50	19.5	118.0	MK 2	3
G13837.0	37.00	4.80	21.7	118.0	MK 2	3
G13840.0	40.00	10.00	20.5	140.0	MK 3	3
G13850.0	50.00	14.00	24.1	150.0	MK 3	3
G13863.0	63.00	16.00	28.5	180.0	MK 4	3

G338



Avellanador HSS a 90°, Mango Cónico, con Recubrimiento TiN

Avellanador de 90° diseñado para achaflanar agujeros para tornillos estándar y para eliminar rebabas en agujeros taladrados. Rendimiento mejorado para mecanizar durante largos periodos a alta velocidad. El mango cónico permite sujetar la herramienta directamente en el husillo. El recubrimiento TiN mejora el rendimiento y prolonga la vida útil de la herramienta. Adecuado para la mayoría de materiales.

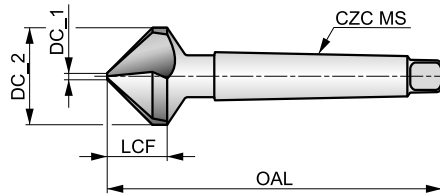

HSS	TiN	DIN 335D
R	90°	

Grupo de Material de la pieza adecuado y condiciones de velocidad de corte iniciales (m/min) y código de avance alfabético. Tablas con avance por revolución a partir de la pag.280.

P1.1 ■ 33 E	P1.2 ■ 37 E	P1.3 ■ 38 E	P2.1 ■ 28 E	P2.2 ■ 25 D	P2.3 ■ 22 B	P3.1 ■ 23 D	P3.2 ■ 18 D	P3.3 ■ 15 B	P4.1 ■ 13 D	P4.2 ■ 11 B	P4.3 ▧ 9 B	M1.1 ▧ 11 C	M1.2 ▧ 9 C
M2.1 ▧ 10 C	M2.2 ▧ 19 C	M2.3 ▧ 8 B	K1.1 ■ 34 F	K1.2 ■ 25 D	K1.3 ▧ 19 D	K2.1 ■ 35 C	K2.2 ■ 28 C	K2.3 ▧ 23 C	K3.1 ■ 31 C	K3.2 ■ 24 C	K3.3 ▧ 19 C	K4.1 ▧ 29 C	K4.2 ▧ 22 C
K4.3 ▧ 16 C	K5.1 ■ 32 C	K5.2 ■ 24 C	K5.3 ▧ 19 C	N1.1 ■ 53 G	N1.2 ■ 40 G	N1.3 ■ 27 F	N2.1 ■ 27 F	N2.2 ■ 24 F	N2.3 ■ 17 F	N3.1 ■ 28 F	N3.2 ■ 16 F	N3.3 ▧ 18 D	N4.1 ▧ 18 D
N4.2 ▧ 50 G													

Product	DC_2 (mm)	DC_1 (mm)	LCF (mm)	OAL (mm)	CZC MS	NOF
G33825.0	25.00	3.80	15.5	106.0	MK 2	3
G33831.0	31.00	4.20	20.0	112.0	MK 2	3
G33837.0	37.00	4.80	21.7	118.0	MK 2	3
G33840.0	40.00	10.00	20.5	140.0	MK 3	3
G33850.0	50.00	14.00	24.1	150.0	MK 3	3

Código de Material (BMC)	HSS-E	HSS-E	HSS-E	HSS-E	HSS-E	HSS-E	HSS	HSS						
Recubrimiento	Bright ST	Bright	Bright	Bright	Bright ST	Bright	Bright ST	ST						
Grupo básico estándar (BSG)	BS 328	DIN 212	DIN 212	DIN 208	BS 328	DIN 2180	DIN 311	ANSI						
Mano (dirección de corte)														
Mango														
Forma del Escariador	B	B	B	B	B									
Tolerancia del agujero alcanzable (TCHA)	H7	H7	$\begin{matrix} \phi 95-5.5 \\ +0.004 \\ \phi 5.51-12 \\ +0.005 \end{matrix}$	H7	H7		k11							
Gradiente cónico (tasa de cónico) - milímetros (TG)						1:50								



Código de Familia de Producto	B901	B180	B170	B161	B101	B954	B121	B640						
Gama de diámetros de corte PSF	1.50 - 1/2	1.50 - 20.00	1.00 - 12.00	3.00 - 50.00	3.00 - 50.00	8.00 - 30.00	12.00 - 25.00	7/16 - 1.1/16						
	168	169	171	173	174	175	176	177						

P	P1	■	■	■	■	■	■	■						
	P2	■	■	■	■	■	■	■						
	P3	■	■	■	■	■	▣	■						
	P4	▣	▣	▣	▣	▣	▣	▣	■					
M	M1	▣	▣	▣	▣	▣	▣							
	M2	▣	▣	▣	▣	▣								
	M3													
	M4													
K	K1	■	■	■	■	■	■	■						
	K2	■	■	■	■	■	■	■						
	K3	▣	▣	▣	▣	▣	▣	▣						
	K4													
	K5													
N	N1	■	■	■	■	■	■	■						
	N2	■	■	■	■	■	■	■						
	N3	■	■	■	■	■	■	■						
	N4	▣	▣	▣	▣	▣	▣	▣						
	N5													
S	S1													
	S2													
	S3													
	S4													
H	H1													
	H2													
	H3													
	H4													

B901



Escariador de Máquina HSS-E, Mango Cilíndrico, Tolerancia H7, Acabado Brillante/Templado al Vapor

La geometría rectificada de precisión, con hélice a izquierda y acción de corte a derecha, mejora el acabado superficial y el tamaño del agujero. El escariador tiene mango recto para conseguir un escariado de alto rendimiento en máquinas. Adecuado para escariar en muchos materiales.

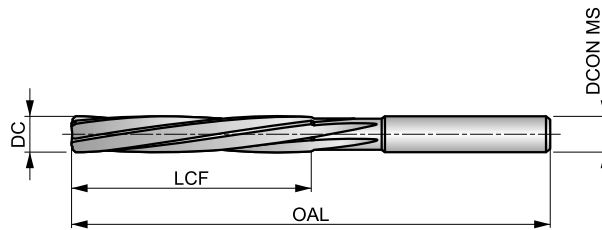

HSS-E	Bright ST	BS 328
R		B
H7		

Grupo de Material de la pieza adecuado y condiciones de velocidad de corte iniciales (m/min) y código de avance alfabético. Tablas con avance por revolución a partir de la pag.279.

P1.1 ■ 15 C	P1.2 ■ 16 C	P1.3 ■ 17 C	P2.1 ■ 13 C	P2.2 ■ 11 C	P2.3 ▣ 10 B	P3.1 ■ 7 B	P3.2 ■ 6 B	P3.3 ▣ 5 B	P4.1 ■ 4 B	P4.2 ▣ 4 B	P4.3 ▣ 3 A	M1.1 ▣ 10 C	M1.2 ▣ 8 C
M2.1 ▣ 9 C	K1.1 ■ 14 E	K1.2 ■ 10 D	K1.3 ▣ 8 D	K2.1 ■ 12 C	K2.2 ■ 10 C	K2.3 ▣ 8 C	K3.1 ▣ 11 C	K3.2 ▣ 8 C	N1.1 ▣ 23 F	N1.2 ■ 17 F	N1.3 ■ 12 F	N2.1 ■ 25 E	N2.2 ■ 22 E
N2.3 ▣ 14 E	N3.1 ■ 34 D	N3.2 ■ 20 E	N3.3 ■ 10 D	N4.1 ▣ 22 B	N4.2 ▣ 21 B								

Product	DC (inch)	DC (mm)	OAL (mm)	LCF (mm)	NOF (mm)	DCON MS (mm)
B9011.5	—	1.50	44.0	21.0	4	1.50
B9012.0	—	2.00	50.0	25.0	4	2.00
B9013/32	3/32	2.38	58.0	29.0	4	2.38
B9012.5	—	2.50	58.0	29.0	4	2.50
B9013.0	—	3.00	62.0	31.0	4	3.00
B9011/8	1/8	3.18	66.0	33.0	4	3.18
B9015/32	5/32	3.97	76.0	38.0	6	3.97
B9014.0	—	4.00	76.0	38.0	6	4.00
B9013/16	3/16	4.76	87.0	44.0	6	4.76
B9015.0	—	5.00	87.0	44.0	6	5.00
B90115/64	15/64	5.95	93.0	47.0	6	5.95
B9016.0	—	6.00	93.0	47.0	6	6.00

Product	DC (inch)	DC (mm)	OAL (mm)	LCF (mm)	NOF (mm)	DCON MS (mm)
B9011/4	1/4	6.35	100.0	50.0	6	6.35
B9017.0	—	7.00	107.0	54.0	6	7.00
B9019/32	9/32	7.14	107.0	54.0	6	7.14
B9015/16	5/16	7.94	115.0	58.0	6	7.94
B9018.0	—	8.00	115.0	58.0	6	8.00
B9019.0	—	9.00	124.0	62.0	6	9.00
B9013/8	3/8	9.52	133.0	66.0	6	9.52
B90110.0	—	10.00	133.0	66.0	6	10.00
B90111.0	—	11.00	142.0	71.0	6	11.00
B9017/16	7/16	11.11	142.0	71.0	6	11.11
B90112.0	—	12.00	152.0	76.0	6	12.00
B9011/2	1/2	12.70	152.0	76.0	6	12.70

B180



Escariador de Máquina HSS-E, Mango Cilíndrico, Tolerancia H7, Acabado Brillante

Escariador de alto rendimiento para máquinas CNC y montaje en portaherramientas o mandriles de alta precisión. La hélice rectificada con precisión a izquierda y la acción de corte a derecha garantizan un escariado suave y un mejor acabado superficial y tamaño del agujero. Adecuado para escariar en muchos materiales.

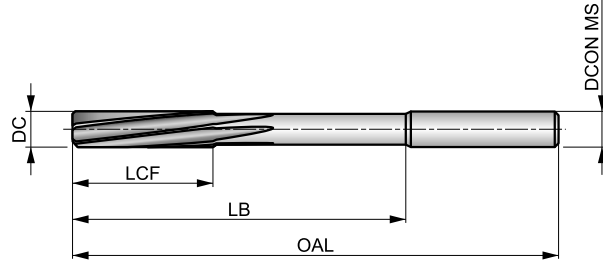

HSS-E	Bright	DIN 212
R	DIN 6535HA	B
H7		

Grupo de Material de la pieza adecuado y condiciones de velocidad de corte iniciales (m/min) y código de avance alfabético. Tablas con avance por revolución a partir de la pag.279.

P1.1 ■ 21 C	P1.2 ■ 24 C	P1.3 ■ 25 C	P2.1 ■ 18 C	P2.2 ■ 16 C	P2.3 ■ 14 B	P3.1 ■ 13 B	P3.2 ■ 11 B	P3.3 ■ 9 B	P4.1 ■ 8 B	P4.2 ■ 7 B	P4.3 ■ 5 A	M1.1 ■ 11 C	M1.2 ■ 10 B
M2.1 ■ 9 B	K1.1 ■ 16 E	K1.2 ■ 12 D	K1.3 ■ 9 D	K2.1 ■ 16 C	K2.2 ■ 13 C	K2.3 ■ 10 C	K3.1 ■ 14 C	K3.2 ■ 11 C	N1.1 ■ 24 F	N1.2 ■ 18 F	N1.3 ■ 11 F	N2.1 ■ 27 E	N2.2 ■ 24 E
N2.3 ■ 16 E	N3.1 ■ 47 D	N3.2 ■ 28 E	N3.3 ■ 14 D	N4.1 ■ 30 B									

DCON MS tolerancia h6.

Product	DC (mm)	OAL (mm)	LCF (mm)	LB (mm)	NOF	DCON MS (mm)
B1801.5	1.50	40.0	8.0	18.00	3	2.00
B1801.6	1.60	43.0	9.0	20.00	3	2.00
B1801.7	1.70	43.0	9.0	20.00	3	2.00
B1801.8	1.80	46.0	10.0	22.00	4	2.00
B1801.9	1.90	46.0	10.0	22.00	4	2.00
B1802.0	2.00	49.0	11.0	24.00	4	2.00
B1802.1	2.10	49.0	11.0	24.00	4	2.00
B1802.2	2.20	53.0	12.0	26.00	4	3.00
B1802.3	2.30	53.0	12.0	26.00	4	3.00
B1802.4	2.40	57.0	14.0	28.00	4	3.00
B1802.5	2.50	57.0	14.0	28.00	4	3.00
B1802.6	2.60	57.0	14.0	28.00	4	3.00
B1802.7	2.70	61.0	15.0	32.00	6	3.00
B1802.8	2.80	61.0	15.0	32.00	6	3.00
B1802.9	2.90	61.0	15.0	32.00	6	3.00
B1803.0	3.00	61.0	15.0	32.00	6	3.00
B1803.1	3.10	65.0	16.0	35.00	6	4.00
B1803.2	3.20	65.0	16.0	35.00	6	4.00
B1803.3	3.30	65.0	16.0	35.00	6	4.00
B1803.4	3.40	70.0	18.0	40.00	6	4.00
B1803.5	3.50	70.0	18.0	40.00	6	4.00
B1803.6	3.60	70.0	18.0	40.00	6	4.00
B1803.9	3.90	75.0	19.0	43.00	6	4.00
B1804.0	4.00	75.0	19.0	43.00	6	4.00
B1804.1	4.10	75.0	19.0	43.00	6	4.00
B1804.2	4.20	75.0	19.0	43.00	6	4.00
B1804.3	4.30	80.0	21.0	47.00	6	5.00

Product	DC (mm)	OAL (mm)	LCF (mm)	LB (mm)	NOF	DCON MS (mm)
B1804.5	4.50	80.0	21.0	47.00	6	5.00
B1804.6	4.60	80.0	21.0	47.00	6	5.00
B1804.7	4.70	80.0	21.0	47.00	6	5.00
B1804.8	4.80	86.0	23.0	52.00	6	5.00
B1804.9	4.90	86.0	23.0	52.00	6	5.00
B1805.0	5.00	86.0	23.0	52.00	6	5.00
B1805.1	5.10	86.0	23.0	52.00	6	5.00
B1805.2	5.20	86.0	23.0	52.00	6	5.00
B1805.3	5.30	86.0	23.0	52.00	6	5.00
B1805.4	5.40	93.0	26.0	57.00	6	6.00
B1805.5	5.50	93.0	26.0	57.00	6	6.00
B1805.6	5.60	93.0	26.0	57.00	6	6.00
B1805.7	5.70	93.0	26.0	57.00	6	6.00
B1805.9	5.90	93.0	26.0	57.00	6	6.00
B1806.0	6.00	93.0	26.0	57.00	6	6.00
B1806.1	6.10	101.0	28.0	63.00	6	6.00
B1806.2	6.20	101.0	28.0	63.00	6	6.00
B1806.3	6.30	101.0	28.0	63.00	6	6.00
B1806.4	6.40	101.0	28.0	63.00	6	6.00
B1806.5	6.50	101.0	28.0	63.00	6	6.00
B1806.6	6.60	101.0	28.0	63.00	6	6.00
B1806.7	6.70	101.0	28.0	63.00	6	6.00
B1806.8	6.80	109.0	31.0	69.00	6	8.00
B1807.0	7.00	109.0	31.0	69.00	6	8.00
B1807.1	7.10	109.0	31.0	69.00	6	8.00
B1807.2	7.20	109.0	31.0	69.00	6	8.00
B1807.5	7.50	109.0	31.0	69.00	6	8.00



Product	DC	OAL	LCF	LB	NOF	DCON MS
	(mm)	(mm)	(mm)	(mm)		(mm)
B1807.8	7.80	117.0	33.0	75.00	6	8.00
B1807.9	7.90	117.0	33.0	75.00	6	8.00
B1808.0	8.00	117.0	33.0	75.00	6	8.00
B1808.1	8.10	117.0	33.0	75.00	6	8.00
B1808.2	8.20	117.0	33.0	75.00	6	8.00
B1808.3	8.30	117.0	33.0	75.00	6	8.00
B1808.4	8.40	117.0	33.0	75.00	6	8.00
B1808.5	8.50	117.0	33.0	75.00	6	8.00
B1808.7	8.70	125.0	36.0	81.00	6	10.00
B1808.8	8.80	125.0	36.0	81.00	6	10.00
B1809.0	9.00	125.0	36.0	81.00	6	10.00
B1809.5	9.50	125.0	36.0	81.00	6	10.00

Product	DC	OAL	LCF	LB	NOF	DCON MS
	(mm)	(mm)	(mm)	(mm)		(mm)
B1809.6	9.60	133.0	38.0	87.00	6	10.00
B18010.0	10.00	133.0	38.0	87.00	6	10.00
B18011.0	11.00	142.0	41.0	96.00	6	10.00
B18012.0	12.00	151.0	44.0	105.00	6	10.00
B18013.0	13.00	151.0	44.0	105.00	6	10.00
B18014.0	14.00	160.0	47.0	110.00	8	14.00
B18015.0	15.00	162.0	50.0	112.00	8	14.00
B18016.0	16.00	170.0	52.0	120.00	8	14.00
B18017.0	17.00	175.0	54.0	123.00	8	14.00
B18018.0	18.00	182.0	56.0	130.00	8	14.00
B18019.0	19.00	189.0	58.0	131.00	8	16.00
B18020.0	20.00	195.0	60.0	137.00	8	16.00

B170



Escariador de Máquina HSS-E Centesimal, Mango Cilíndrico, Incrementos de 0.01 mm, Acabado Brillante

Los diferentes incrementos de tamaño le permiten producir agujeros precisos y tolerancias adicionales. Con una hélice a izquierda y una acción de corte a derecha, la geometría rectificada de precisión proporciona un escariado suave y mejora el tamaño del agujero y el acabado superficial. Adecuado para escariar en muchos materiales.

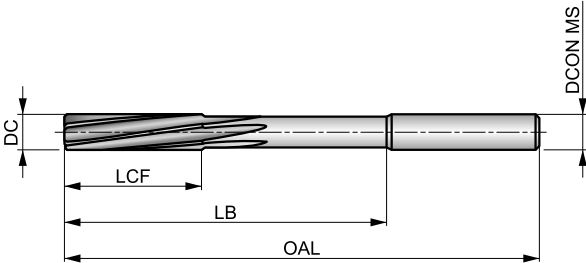

HSS-E	Bright	DIN 212
R		B
ø 95-5.5 +0.004 ø 5.51-12 +0.005		

Grupo de Material de la pieza adecuado y condiciones de velocidad de corte iniciales (m/min) y código de avance alfabético. Tablas con avance por revolución a partir de la pag.279.

P1.1 ■ 21 C	P1.2 ■ 24 C	P1.3 ■ 25 C	P2.1 ■ 18 C	P2.2 ■ 16 C	P2.3 ■ 14 B	P3.1 ■ 13 B	P3.2 ■ 11 B	P3.3 ■ 9 B	P4.1 ■ 8 B	P4.2 ■ 7 B	P4.3 ■ 5 A	M1.1 ■ 11 C	M1.2 ■ 10 B
M2.1 ■ 9 B	K1.1 ■ 16 E	K1.2 ■ 12 D	K1.3 ■ 9 D	K2.1 ■ 16 C	K2.2 ■ 13 C	K2.3 ■ 10 C	K3.1 ■ 14 C	K3.2 ■ 11 C	N1.1 ■ 24 D	N1.2 ■ 18 F	N1.3 ■ 11 F	N2.1 ■ 27 E	N2.2 ■ 24 E
N2.3 ■ 16 E	N3.1 ■ 47 D	N3.2 ■ 28 E	N3.3 ■ 14 D	N4.1 ■ 30 B									

DCON MS tolerancia h9.

Product	DC	OAL	LCF	LB	NOF	DCON MS
	(mm)	(mm)	(mm)	(mm)		(mm)
B1701.0	1.00	34.0	5.5	15.00	3	1.00
B1701.05	1.05	34.0	5.5	15.00	3	1.00
B1701.49	1.49	40.0	8.0	18.00	3	1.50
B1701.5	1.50	40.0	8.0	18.00	3	1.50
B1701.52	1.52	43.0	9.0	20.00	3	1.60
B1701.98	1.98	49.0	11.0	24.00	4	2.00
B1701.99	1.99	49.0	11.0	24.00	4	2.00
B1702.0	2.00	49.0	11.0	24.00	4	2.00
B1702.01	2.01	49.0	11.0	24.00	4	2.00
B1702.02	2.02	49.0	11.0	24.00	4	2.00
B1702.03	2.03	49.0	11.0	24.00	4	2.00
B1702.05	2.05	49.0	11.0	24.00	4	2.00
B1702.5	2.50	57.0	14.0	28.00	4	2.50
B1702.51	2.51	57.0	14.0	28.00	4	2.50
B1702.98	2.98	61.0	15.0	32.00	6	3.00
B1702.99	2.99	61.0	15.0	32.00	6	3.00
B1703.0	3.00	61.0	15.0	32.00	6	3.00
B1703.01	3.01	65.0	16.0	35.00	6	3.20
B1703.02	3.02	65.0	16.0	35.00	6	3.20
B1703.03	3.03	65.0	16.0	35.00	6	3.20
B1703.05	3.05	65.0	16.0	35.00	6	3.20
B1703.98	3.98	75.0	19.0	43.00	6	4.00
B1703.99	3.99	75.0	19.0	43.00	6	4.00
B1704.0	4.00	75.0	19.0	43.00	6	4.00
B1704.01	4.01	75.0	19.0	43.00	6	4.00
B1704.02	4.02	75.0	19.0	43.00	6	4.00
B1704.03	4.03	75.0	19.0	43.00	6	4.00

Product	DC	OAL	LCF	LB	NOF	DCON MS
	(mm)	(mm)	(mm)	(mm)		(mm)
B1704.04	4.04	75.0	19.0	43.00	6	4.00
B1704.05	4.05	75.0	19.0	43.00	6	4.00
B1704.98	4.98	86.0	23.0	52.00	6	5.00
B1704.99	4.99	86.0	23.0	52.00	6	5.00
B1705.0	5.00	86.0	23.0	52.00	6	5.00
B1705.01	5.01	86.0	23.0	52.00	6	5.00
B1705.02	5.02	86.0	23.0	52.00	6	5.00
B1705.03	5.03	86.0	23.0	52.00	6	5.00
B1705.04	5.04	86.0	23.0	52.00	6	5.00
B1705.05	5.05	86.0	23.0	52.00	6	5.00
B1705.5	5.50	93.0	26.0	57.00	6	5.60
B1705.98	5.98	93.0	26.0	57.00	6	5.60
B1705.99	5.99	93.0	26.0	57.00	6	5.60
B1706.0	6.00	93.0	26.0	57.00	6	5.60
B1706.01	6.01	101.0	28.0	63.00	6	6.30
B1706.02	6.02	101.0	28.0	63.00	6	6.30
B1706.03	6.03	101.0	28.0	63.00	6	6.30
B1706.04	6.04	101.0	28.0	63.00	6	6.30
B1706.05	6.05	101.0	28.0	63.00	6	6.30
B1706.51	6.51	101.0	28.0	63.00	6	6.30
B1706.98	6.98	109.0	31.0	69.00	6	7.10
B1706.99	6.99	109.0	31.0	69.00	6	7.10
B1707.0	7.00	109.0	31.0	69.00	6	7.10
B1707.01	7.01	109.0	31.0	69.00	6	7.10
B1707.02	7.02	109.0	31.0	69.00	6	7.10
B1707.05	7.05	109.0	31.0	69.00	6	7.10
B1707.98	7.98	117.0	33.0	75.00	6	8.00



Product	DC	OAL	LCF	LB	NOF	DCON MS
	(mm)	(mm)	(mm)	(mm)		(mm)
B1707.99	7.99	117.0	33.0	75.00	6	8.00
B1708.0	8.00	117.0	33.0	75.00	6	8.00
B1708.01	8.01	117.0	33.0	75.00	6	8.00
B1708.02	8.02	117.0	33.0	75.00	6	8.00
B1708.03	8.03	117.0	33.0	75.00	6	8.00
B1708.04	8.04	117.0	33.0	75.00	6	8.00
B1708.05	8.05	117.0	33.0	75.00	6	8.00
B1708.98	8.98	125.0	36.0	81.00	6	9.00
B1709.0	9.00	125.0	36.0	81.00	6	9.00
B1709.01	9.01	125.0	36.0	81.00	6	9.00
B1709.02	9.02	125.0	36.0	81.00	6	9.00
B1709.05	9.05	125.0	36.0	81.00	6	9.00
B1709.5	9.50	125.0	36.0	81.00	6	9.00
B1709.51	9.51	133.0	38.0	87.00	6	10.00

Product	DC	OAL	LCF	LB	NOF	DCON MS
	(mm)	(mm)	(mm)	(mm)		(mm)
B1709.52	9.52	133.0	38.0	87.00	6	10.00
B1709.98	9.98	133.0	38.0	87.00	6	10.00
B1709.99	9.99	133.0	38.0	87.00	6	10.00
B17010.0	10.00	133.0	38.0	87.00	6	10.00
B17010.01	10.01	133.0	38.0	87.00	6	10.00
B17010.02	10.02	133.0	38.0	87.00	6	10.00
B17010.03	10.03	133.0	38.0	87.00	6	10.00
B17010.04	10.04	133.0	38.0	87.00	6	10.00
B17010.05	10.05	133.0	38.0	87.00	6	10.00
B17010.98	10.98	142.0	41.0	96.00	6	10.00
B17011.98	11.98	151.0	44.0	105.00	6	10.00
B17011.99	11.99	151.0	44.0	105.00	6	10.00
B17012.0	12.00	151.0	44.0	105.00	6	10.00

B161



Escariador de Máquina HSS-E, Mango Cónico, Tolerancia H7, Acabado Brillante/Templado al Vapor

La hélice rectificada con precisión a izquierda y la acción de corte a derecha garantizan un escariado suave y un mejor acabado superficial y tamaño del agujero. Adecuado para escariar en muchos materiales.

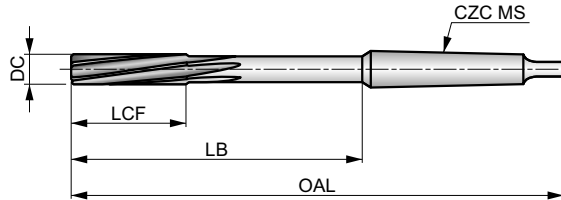

HSS-E	Bright	DIN 208
R		B
H7		

Grupo de Material de la pieza adecuado y condiciones de velocidad de corte iniciales (m/min) y código de avance alfabético. Tablas con avance por revolución a partir de la pag.279.

P1.1 ■ 21 C	P1.2 ■ 24 C	P1.3 ■ 25 C	P2.1 ■ 18 C	P2.2 ■ 16 C	P2.3 ■ 14 B	P3.1 ■ 13 B	P3.2 ■ 11 B	P3.3 ■ 9 B	P4.1 ■ 8 B	P4.2 ■ 7 B	P4.3 ■ 5 A	M1.1 ■ 11 C	M1.2 ■ 10 B
M2.1 ■ 9 B	K1.1 ■ 16 E	K1.2 ■ 12 D	K1.3 ■ 9 D	K2.1 ■ 16 C	K2.2 ■ 13 C	K2.3 ■ 10 C	K3.1 ■ 14 C	K3.2 ■ 11 C	N1.1 ■ 24 F	N1.2 ■ 18 F	N1.3 ■ 11 F	N2.1 ■ 27 E	N2.2 ■ 24 E
N2.3 ■ 16 E	N3.1 ■ 47 D	N3.2 ■ 28 E	N3.3 ■ 14 D	N4.1 ■ 30 B									

Product	DC (mm)	OAL (mm)	LCF (mm)	LB (mm)	NOF	CZC MS
B1613.0	3.00	113.0	15.0	47.50	6	MK 1
B1614.0	4.00	124.0	19.0	58.50	6	MK 1
B1615.0	5.00	133.0	23.0	67.50	6	MK 1
B1616.0	6.00	138.0	26.0	72.50	6	MK 1
B1617.0	7.00	150.0	31.0	84.50	6	MK 1
B1618.0	8.00	156.0	33.0	90.50	6	MK 1
B1619.0	9.00	162.0	36.0	96.50	6	MK 1
B16110.0	10.00	168.0	38.0	102.50	6	MK 1
B16111.0	11.00	175.0	41.0	109.50	6	MK 1
B16112.0	12.00	182.0	44.0	116.50	6	MK 1
B16113.0	13.00	182.0	44.0	116.50	6	MK 1
B16114.0	14.00	189.0	47.0	123.50	8	MK 1
B16115.0	15.00	204.0	50.0	124.00	8	MK 2
B16116.0	16.00	210.0	52.0	130.00	8	MK 2
B16117.0	17.00	214.0	54.0	134.00	8	MK 2
B16118.0	18.00	219.0	56.0	139.00	8	MK 2
B16119.0	19.00	223.0	58.0	143.00	8	MK 2
B16120.0	20.00	228.0	60.0	148.00	8	MK 2

Product	DC (mm)	OAL (mm)	LCF (mm)	LB (mm)	NOF	CZC MS
B16121.0	21.00	232.0	62.0	152.00	8	MK 2
B16122.0	22.00	237.0	64.0	157.00	8	MK 2
B16123.0	23.00	241.0	66.0	161.00	8	MK 2
B16124.0	24.00	268.0	68.0	169.00	8	MK 3
B16125.0	25.00	268.0	68.0	169.00	8	MK 3
B16126.0	26.00	273.0	70.0	174.00	8	MK 3
B16127.0	27.00	277.0	71.0	178.00	10	MK 3
B16128.0	28.00	277.0	71.0	178.00	10	MK 3
B16130.0	30.00	281.0	73.0	182.00	10	MK 3
B16132.0	32.00	317.0	77.0	193.00	10	MK 4
B16134.0	34.00	321.0	78.0	197.00	10	MK 4
B16135.0	35.00	321.0	78.0	197.00	10	MK 4
B16138.0	38.00	329.0	81.0	205.00	10	MK 4
B16140.0	40.00	329.0	81.0	205.00	10	MK 4
B16142.0	42.00	333.0	82.0	209.00	12	MK 4
B16145.0	45.00	336.0	83.0	212.00	12	MK 4
B16150.0	50.00	344.0	86.0	220.00	12	MK 4

B101



Escariador HSS-E de Máquina, Mango Cónico, Tolerancia H7

Escariador de máquina de mango cónico según BS 328. La hélice rectificada con precisión a izquierda y la acción de corte a derecha garantizan un escariado suave y un mejor acabado superficial y tamaño del agujero. Adecuado para escariar en muchos materiales.

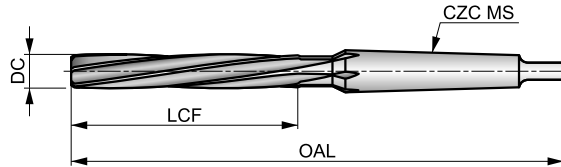

HSS-E	Bright ST	BS 328
R		B
H7		

Grupo de Material de la pieza adecuado y condiciones de velocidad de corte iniciales (m/min) y código de avance alfabético. Tablas con avance por revolución a partir de la pag.279.

P1.1 ■ 15 C	P1.2 ■ 16 C	P1.3 ■ 17 C	P2.1 ■ 13 C	P2.2 ■ 11 C	P2.3 ■ 10 B	P3.1 ■ 7 B	P3.2 ■ 6 B	P3.3 ■ 5 B	P4.1 ■ 4 B	P4.2 ■ 4 B	P4.3 ■ 3 A	M1.1 ■ 7 B	M1.2 ■ 6 A
K1.1 ■ 14 E	K1.2 ■ 10 D	K1.3 ■ 8 D	K2.1 ■ 12 C	K2.2 ■ 10 C	K2.3 ■ 8 C	K3.1 ■ 11 C	K3.2 ■ 8 C	N1.1 ■ 23 F	N1.2 ■ 17 F	N1.3 ■ 9 F	N2.1 ■ 25 E	N2.2 ■ 18 E	N2.3 ■ 14 E
N3.1 ■ 34 D	N3.2 ■ 20 E	N3.3 ■ 10 D	N4.1 ■ 22 B										

Product	DC (inch)	DC (mm)	OAL (mm)	LCF (mm)	NOF	CZC MS
B1013.0	–	3.00	112.0	33.0	4	MK 1
B1014.0	–	4.00	117.0	38.0	6	MK 1
B1013/16	3/16	4.76	124.0	44.0	6	MK 1
B1015.0	–	5.00	124.0	44.0	6	MK 1
B1016.0	–	6.00	127.0	47.0	6	MK 1
B1011/4	1/4	6.35	130.0	50.0	6	MK 1
B1015/16	5/16	7.94	138.0	58.0	6	MK 1
B1018.0	–	8.00	138.0	58.0	6	MK 1
B1013/8	3/8	9.52	146.0	66.0	6	MK 1
B10110.0	–	10.00	146.0	66.0	6	MK 1
B10111.0	–	11.00	151.0	71.0	6	MK 1
B1017/16	7/16	11.11	151.0	71.0	6	MK 1
B10112.0	–	12.00	156.0	76.0	6	MK 1
B1011/2	1/2	12.70	156.0	76.0	6	MK 1
B10113.0	–	13.00	156.0	76.0	6	MK 1
B10114.0	–	14.00	161.0	81.0	8	MK 1
B1019/16	9/16	14.29	181.0	81.0	8	MK 2
B10115.0	–	15.00	181.0	81.0	8	MK 2
B1015/8	5/8	15.88	187.0	87.0	8	MK 2
B10116.0	–	16.00	187.0	87.0	8	MK 2
B10116.5	–	16.50	187.0	87.0	8	MK 2
B10117.0	–	17.00	187.0	87.0	8	MK 2

Product	DC (inch)	DC (mm)	OAL (mm)	LCF (mm)	NOF	CZC MS
B10118.0	–	18.00	193.0	93.0	8	MK 2
B10119.0	–	19.00	193.0	93.0	8	MK 2
B1013/4	3/4	19.05	200.0	100.0	8	MK 2
B10120.0	–	20.00	200.0	100.0	8	MK 2
B10121.0	–	21.00	200.0	100.0	8	MK 2
B10122.0	–	22.00	207.0	107.0	8	MK 2
B1017/8	7/8	22.22	207.0	107.0	8	MK 2
B10123.0	–	23.00	207.0	107.0	8	MK 2
B10124.0	–	24.00	242.0	115.0	8	MK 3
B10125.0	–	25.00	242.0	115.0	10	MK 3
B1011	1"	25.40	242.0	115.0	10	MK 3
B10126.0	–	26.00	242.0	115.0	10	MK 3
B10128.0	–	28.00	251.0	124.0	10	MK 3
B10129.0	–	29.00	251.0	124.0	10	MK 3
B10130.0	–	30.00	251.0	124.0	10	MK 3
B1011.1/4	1.1/4	31.75	260.0	133.0	10	MK 3
B10135.0	–	35.00	302.0	142.0	10	MK 4
B10140.0	–	40.00	312.0	152.0	10	MK 4
B10141.0	–	41.00	312.0	152.0	10	MK 4
B10144.0	–	44.00	323.0	163.0	10	MK 4
B10150.0	–	50.00	334.0	174.0	12	MK 4

B954



Escariador de Máquina HSS-E para Pasadores Cónicos, Conicidad 1:50

Se consigue un escariado suave con precisión y rendimiento mejorados mediante el diseño especial con gran ángulo de hélice a izquierda y el corte a derecha. Diseñado para terminar agujeros para alojar pasadores cónicos métricos de proporción estándar de 1 a 50. Adecuado para escariar en muchos materiales.

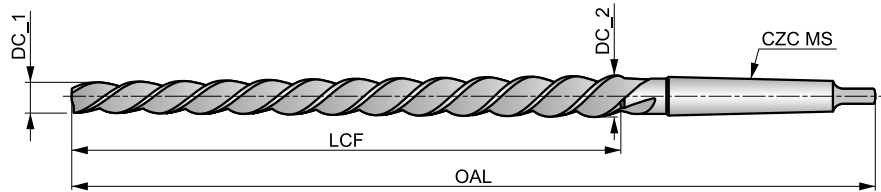

HSS-E	Bright	DIN 2180
R		1:50

Grupo de Material de la pieza adecuado y condiciones de velocidad de corte iniciales (m/min) y código de avance alfabético. Tablas con avance por revolución a partir de la pag.279.

P1.1 ■ 10 B	P1.2 ■ 12 B	P1.3 ■ 13 B	P2.1 ■ 9 B	P2.2 ■ 8 B	P2.3 ▣ 6 A	P3.1 ■ 7 A	P3.2 ■ 6 A	P3.3 ▣ 3 A	P4.1 ■ 4 A	P4.2 ▣ 3 A	P4.3 ▣ 2 A	M1.1 ▣ 11 C	M1.2 ▣ 10 B
M2.1 ▣ 9 B	M2.2 ▣ 8 B	K1.1 ■ 10 C	K1.2 ■ 6 B	K1.3 ▣ 4 B	K2.1 ■ 8 A	K2.2 ■ 6 A	K2.3 ▣ 4 A	K3.1 ■ 11 A	K3.2 ▣ 8 A	N1.1 ▣ 14 F	N1.2 ■ 12 F	N1.3 ■ 9 F	N2.1 ■ 16 E
N2.2 ■ 14 E	N2.3 ▣ 10 E	N3.1 ■ 22 D	N3.2 ■ 14 E	N3.3 ▣ 6 D	N4.1 ▣ 22 B								

Product	nom d	DC_1 (mm)	DC_2 (mm)	OAL (mm)	LCF (mm)	NOF	CZC MS
B9548.0	8.0	7.90	10.80	227.0	145.0	3	MK 1
B95410.0	10.0	9.90	13.40	257.0	175.0	3	MK 1
B95412.0	12.0	11.80	16.00	315.0	210.0	3	MK 2
B95413.0	13.0	12.86	16.74	295.0	194.0	3	MK 2
B95414.0	14.0	13.86	17.74	295.0	194.0	3	MK 2
B95416.0	16.0	15.80	20.40	335.0	230.0	3	MK 2
B95420.0	20.0	19.80	24.80	377.0	250.0	3	MK 3
B95425.0	25.0	24.70	30.70	427.0	300.0	3	MK 3
B95430.0	30.0	29.70	36.10	475.0	320.0	4	MK 4

B121



Escariador HSS de Mango Cónico

Diseñado para realinear agujeros en grandes fabricaciones, donde se unen dos o más piezas, antes de atornillarlas o remacharlas. El pequeño diámetro del piloto del cono de relación 1 a 10 simplifica la necesidad de ubicar y alinear la herramienta en agujeros pretaladrados. Adecuado para escariado en muchos materiales.

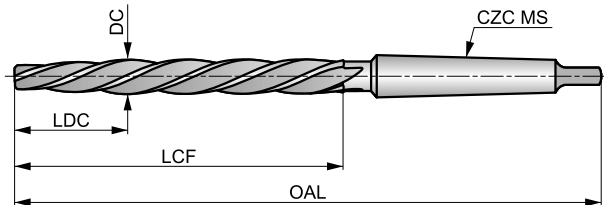

HSS	Bright ST	DIN 311
R		k11

Grupo de Material de la pieza adecuado y condiciones de velocidad de corte iniciales (m/min) y código de avance alfabético. Tablas con avance por revolución a partir de la pag.279.

P1.1 ■ 15 C	P1.2 ■ 16 C	P1.3 ■ 17 C	P2.1 ■ 13 C	P2.2 ■ 11 C	P2.3 ■ 10 B	P3.1 ■ 7 B	P3.2 ■ 6 B	P3.3 ■ 5 B	P4.1 ■ 4 B	P4.2 ■ 4 B	P4.3 ■ 3 A	K1.1 ■ 14 E	K1.2 ■ 10 D
K1.3 ■ 8 D	K2.1 ■ 12 C	K2.2 ■ 10 C	K2.3 ■ 8 C	K3.1 ■ 11 C	K3.2 ■ 8 C	N1.1 ■ 23 F	N1.2 ■ 17 F	N1.3 ■ 9 F	N2.1 ■ 21 E	N2.2 ■ 18 E	N2.3 ■ 14 E	N3.1 ■ 34 D	N3.2 ■ 20 E
N3.3 ■ 10 D	N4.1 ■ 21 B												

Conicidad 1:10 (LDC).

Product	DC (mm)	OAL (mm)	LCF (mm)	LDC (mm)	NOF	CZC MS
B12112.0	12.00	199.0	105.0	39.00	4	MK 2
B12114.0	14.00	209.0	115.0	42.00	4	MK 2
B12116.0	16.00	229.0	135.0	48.00	4	MK 2
B12117.0	17.00	251.0	135.0	51.00	4	MK 3
B12118.0	18.00	261.0	145.0	58.00	4	MK 3
B12120.0	20.00	271.0	155.0	62.00	4	MK 3
B12121.0	21.00	271.0	155.0	62.00	4	MK 3
B12122.0	22.00	281.0	165.0	66.00	4	MK 3
B12124.0	24.00	296.0	180.0	72.00	4	MK 3
B12125.0	25.00	296.0	180.0	72.00	4	MK 3

B640



Escariador guiado HSS de mango cónico, templado al vapor

Se utiliza para realinear agujeros en fabricaciones de gran tamaño, como vigas en I, en las que dos o más piezas se van a unir mediante atornillado o remachado. El extremo inicial más pequeño con un paso cónico largo permite al operario alinear los agujeros pretaladrados desajustados escariando el desajuste. Fabricado según ANSI B94.2-1983 (R1988).

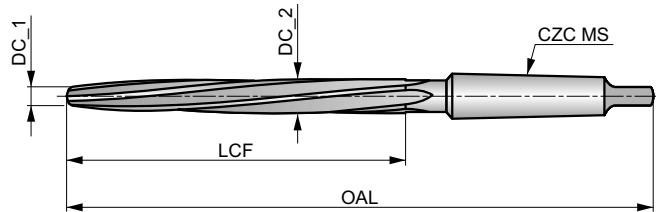

HSS		ANSI

Grupo de Material de la pieza adecuado y condiciones de velocidad de corte iniciales (m/min) y código de avance alfabético. Tablas con avance por revolución a partir de la pag.279.

P1.1 ■ 15 C	P1.2 ■ 16 C	P1.3 ■ 17 C	P2.1 ■ 13 C	P2.2 ■ 11 C	P2.3 ■ 10 B	P3.1 ■ 7 B	P3.2 ■ 6 B	P3.3 ■ 5 B	P4.1 ■ 4 B	P4.2 ■ 4 B	P4.3 ■ 3 A	K1.1 ■ 14 E	K1.2 ■ 10 D
K1.3 ■ 8 D	K2.1 ■ 12 C	K2.2 ■ 10 C	K2.3 ■ 8 C	K3.1 ■ 11 C	K3.2 ■ 8 C	N1.1 ■ 23 F	N1.2 ■ 17 F	N1.3 ■ 9 F	N2.1 ■ 21 E	N2.2 ■ 18 E	N2.3 ■ 14 E	N3.1 ■ 34 D	N3.2 ■ 20 E
N3.3 ■ 10 D	N4.1 ■ 21 B												

Product	nom d	DC_1 (inch)	DC_2 (inch)	CZC MS	LCF (inch)	OAL (inch)	NOF
B6407/16	7/16	0.2500	0.4375	2	4.3/8	8.1/4	5
B6401/2	1/2	0.2813	0.5000	2	5.1/8	9"	5
B6409/16	9/16	0.3438	0.5625	2	5.1/8	9"	5
B6405/8	5/8	0.3750	0.6250	2	6.1/8	10"	5
B64011/16	11/16	0.3906	0.6875	3	7.1/8	11.3/4	5
B6403/4	3/4	0.4375	0.7500	3	7.3/8	12"	5
B64013/16	13/16	0.5000	0.8125	3	7.3/8	12"	5
B6407/8	7/8	0.5625	0.8750	3	7.3/8	12"	5
B64015/16	15/16	0.6250	0.9375	3	7.3/8	12"	5
B6401	1"	0.6875	1.0000	3	7.3/8	12"	5
B6401.1/16	1.1/16	0.7500	1.0625	3	7.3/8	12"	5



**HERRAMIENTAS PARA PROCESOS SEGUROS Y PRODUCTIVIDAD.
UTILIZADAS NORMALMENTE CON CNC Y FABRICACIÓN AUTOMATIZADA.**

Código de Material (BMC)	HM	HM	HM	HM															
Grupo básico estándar (BSG)																			
Longitud Útil (ULDR)	1xD	1xD	1xD	1xD															
Ángulo de aplicación	90°	90°	120°	150°															
Recubrimiento	Bright	TiAlN	Bright	TiAlN															
Mango																			
Forma de la Hélice																			
Mano (dirección de corte)																			

Código de Familia de Producto		R123	R6011	R122	R125														
Gama de diámetros de corte PSF		5.00 - 20.00	6.00 - 16.00	5.00 - 20.00	5.00 - 16.00														
		182	183	184	185														
P	P1	■	■	■	■														
	P2	■	■	■	■														
	P3	■	■	■	■														
	P4	■	■	■	■														
M	M1	■	■	■	■														
	M2	■	■	■	■														
	M3	■	■	■	■														
	M4																		
K	K1	■	■	■	■														
	K2	■	■	■	■														
	K3	■	■	■	■														
	K4	■	■	■	■														
	K5	■	■	■	■														
N	N1	■	■	■	■														
	N2	■	■	■	■														
	N3	■	■	■	■														
	N4	■	■	■	■														
	N5																		
S	S1	■	■	■	■														
	S2	■	■	■	■														
	S3	■	■	■	■														
	S4	■	■	■	■														
H	H1	■	■	■	■														
	H2	▣	▣	▣	▣														
	H3	▣	▣	▣	▣														
	H4																		

R123



Broca de Centrar de Metal Duro, Punta a 90°

El ángulo de punta diseñado con precisión proporciona una guía precisa para favorecer el centrado de la siguiente broca. El ángulo de punta de 90° mejora el autocentrado y reduce las fuerzas de corte al taladrar una gran variedad de materiales.

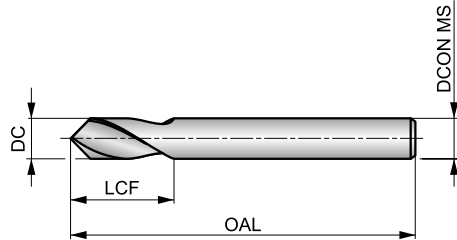

HM		1xD
90°	Bright	
λ 20-35°		DC h6

Grupo de Material de la pieza adecuado y condiciones de velocidad de corte iniciales (m/min) y código de avance alfabético. Tablas con avance por revolución a partir de la pag.274.

P1.1 ■ 99 S	P1.2 ■ 111 S	P1.3 ■ 115 S	P2.1 ■ 85 S	P2.2 ■ 75 S	P2.3 ■ 66 S	P3.1 ■ 66 S	P3.2 ■ 53 S	P3.3 ■ 45 S	P4.1 ■ 40 S	P4.2 ■ 34 S	P4.3 ■ 27 S	M1.1 ■ 73 S	M1.2 ■ 61 S
M2.1 ■ 65 S	M2.2 ■ 53 S	M3.1 ■ 52 S	M3.2 ■ 45 S	K1.1 ■ 75 T	K1.2 ■ 56 T	K1.3 ■ 42 T	K2.1 ■ 68 T	K2.2 ■ 55 T	K2.3 ■ 44 T	K3.1 ■ 60 T	K3.2 ■ 46 T	K3.3 ■ 37 T	K4.1 ■ 55 T
K4.2 ■ 42 T	K4.3 ■ 31 T	K4.4 ■ 26 T	K4.5 ■ 22 T	K5.1 ■ 63 T	K5.2 ■ 47 T	K5.3 ■ 37 T	N1.1 ■ 200 V	N1.2 ■ 150 V	N1.3 ■ 100 V	N2.1 ■ 172 V	N2.2 ■ 155 V	N2.3 ■ 112 V	N3.1 ■ 423 V
N3.2 ■ 250 V	N3.3 ■ 125 V	N4.1 ■ 60 X	N4.2 ■ 100 V	S1.1 ■ 45 T	S1.2 ■ 35 T	S1.3 ■ 25 S	S2.1 ■ 40 S	S2.2 ■ 28 S	S3.1 ■ 30 S	S3.2 ■ 20 S	S4.1 ■ 23 S	S4.2 ■ 16 S	H1.1 ■ 56 S
H2.1 ■ 33 S	H2.2 ■ 36 S	H3.1 ■ 37 S	H3.2 ■ 30 S										

Product	DC	DC	LCF	OAL	DCON MS
	(mm)	(inch)			
R1235.0	5.00	0.1969	16.0	62.0	5.00
R1236.0	6.00	0.2362	17.0	66.0	6.00
R1238.0	8.00	0.3150	22.0	79.0	8.00
R12310.0	10.00	0.3937	26.0	89.0	10.00
R12312.0	12.00	0.4724	30.0	102.0	12.00
R12316.0	16.00	0.6299	34.0	115.0	16.00
R12320.0	20.00	0.7874	40.0	131.0	20.00

R6011



Broca de Centrar de Metal Duro, Punta a 90°, Recubrimiento TiAIN

El ángulo de punta diseñado con precisión proporciona una guía precisa para favorecer el centrado de la siguiente broca. El ángulo de punta de 90° mejora el autocentrado y reduce las fuerzas de corte al taladrar. El recubrimiento TiAIN mejora el rendimiento y prolonga la vida útil de la herramienta. Adecuada para taladrar muchos materiales.

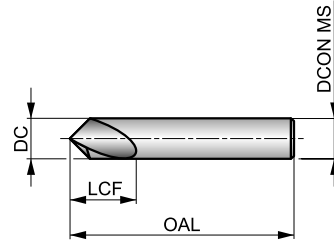

HM	DORMER	1xD
90°	TiAIN	DIN 6535HA
λ 20-35°	R	DC h6

Grupo de Material de la pieza adecuado y condiciones de velocidad de corte iniciales (m/min) y código de avance alfabético. Tablas con avance por revolución a partir de la pag.274.

P1.1 ■ 119 S	P1.2 ■ 134 S	P1.3 ■ 138 S	P2.1 ■ 102 S	P2.2 ■ 90 S	P2.3 ■ 80 S	P3.1 ■ 81 S	P3.2 ■ 65 S	P3.3 ■ 55 S	P4.1 ■ 48 S	P4.2 ■ 41 S	P4.3 ■ 34 S	M1.1 ■ 82 S	M1.2 ■ 70 S
M2.1 ■ 73 S	M2.2 ■ 60 S	M3.1 ■ 58 S	M3.2 ■ 50 S	K1.1 ■ 80 T	K1.2 ■ 59 T	K1.3 ■ 44 T	K2.1 ■ 86 T	K2.2 ■ 70 T	K2.3 ■ 56 T	K3.1 ■ 76 T	K3.2 ■ 58 T	K3.3 ■ 47 T	K4.1 ■ 71 T
K4.2 ■ 53 T	K4.3 ■ 39 T	K4.4 ■ 33 T	K4.5 ■ 28 T	K5.1 ■ 80 T	K5.2 ■ 60 T	K5.3 ■ 46 T	N1.1 ■ 200 V	N1.2 ■ 150 V	N1.3 ■ 100 V	N2.1 ■ 172 V	N2.2 ■ 155 V	N2.3 ■ 112 V	N3.1 ■ 423 V
N3.2 ■ 250 V	N3.3 ■ 125 V	N4.1 ■ 60 X	N4.2 ■ 100 V	S1.1 ■ 55 T	S1.2 ■ 45 T	S1.3 ■ 35 S	S2.1 ■ 53 S	S2.2 ■ 42 S	S3.1 ■ 40 S	S3.2 ■ 30 S	S4.1 ■ 31 S	S4.2 ■ 24 S	H1.1 ■ 56 S
H2.1 ■ 33 S	H2.2 ■ 36 S	H3.1 ■ 37 S	H3.2 ■ 30 S										

DCON MS tolerancia h6.

Product	DC	DC	LCF	OAL	DCON MS
	(mm)	(inch)	(mm)	(mm)	(mm)
R60116.0	6.00	0.2362	16.0	50.0	6.00
R601110.0	10.00	0.3937	25.0	70.0	10.00
R601116.0	16.00	0.6299	26.0	90.0	16.00

R122



Broca de Centrar de Metal Duro, Punta a 120°

El ángulo de punta diseñado con precisión proporciona una guía precisa para favorecer el centrado de la siguiente broca. El ángulo de punta de 120° mejora el auto-centrado y reduce las fuerzas de corte al taladrar una gran variedad de materiales.

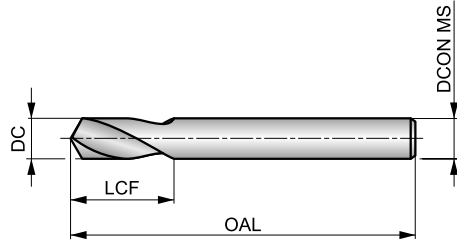

HM		1xD
120°	Bright	
λ 20-35°		DC h6

Grupo de Material de la pieza adecuado y condiciones de velocidad de corte iniciales (m/min) y código de avance alfabético. Tablas con avance por revolución a partir de la pag.274.

P1.1 ■ 99 S	P1.2 ■ 111 S	P1.3 ■ 115 S	P2.1 ■ 85 S	P2.2 ■ 75 S	P2.3 ■ 66 S	P3.1 ■ 66 S	P3.2 ■ 53 S	P3.3 ■ 45 S	P4.1 ■ 40 S	P4.2 ■ 34 S	P4.3 ■ 27 S	M1.1 ■ 73 S	M1.2 ■ 61 S
M2.1 ■ 65 S	M2.2 ■ 53 S	M3.1 ■ 52 S	M3.2 ■ 45 S	K1.1 ■ 75 T	K1.2 ■ 56 T	K1.3 ■ 42 T	K2.1 ■ 68 T	K2.2 ■ 55 T	K2.3 ■ 44 T	K3.1 ■ 60 T	K3.2 ■ 46 T	K3.3 ■ 37 T	K4.1 ■ 55 T
K4.2 ■ 42 T	K4.3 ■ 31 T	K4.4 ■ 26 T	K4.5 ■ 22 T	K5.1 ■ 63 T	K5.2 ■ 47 T	K5.3 ■ 37 T	N1.1 ■ 200 V	N1.2 ■ 150 V	N1.3 ■ 100 V	N2.1 ■ 172 V	N2.2 ■ 155 V	N2.3 ■ 112 V	N3.1 ■ 423 V
N3.2 ■ 250 V	N3.3 ■ 125 V	N4.1 ■ 60 X	N4.2 ■ 100 V	S1.1 ■ 45 T	S1.2 ■ 35 T	S1.3 ■ 25 S	S2.1 ■ 40 S	S2.2 ■ 28 S	S3.1 ■ 30 S	S3.2 ■ 20 S	S4.1 ■ 23 S	S4.2 ■ 16 S	H1.1 ■ 56 S
H2.1 ■ 33 S	H2.2 ■ 36 S	H3.1 ■ 37 S	H3.2 ■ 30 S										

Product	DC	DC	LCF	OAL	DCON MS
	(mm)	(inch)			
R1225.0	5.00	0.1969	16.0	62.0	5.00
R1226.0	6.00	0.2362	17.0	66.0	6.00
R1228.0	8.00	0.3150	22.0	79.0	8.00
R12210.0	10.00	0.3937	26.0	89.0	10.00
R12212.0	12.00	0.4724	30.0	102.0	12.00
R12216.0	16.00	0.6299	34.0	115.0	16.00
R12220.0	20.00	0.7874	40.0	131.0	20.00

R125



Broca de Centrar de Metal Duro, Punta a 150°, Recubrimiento TiAlN

El ángulo de punta diseñado con precisión proporciona una guía precisa para favorecer el centrado de la siguiente broca. El ángulo de punta de 150° mejora el autocentrado y reduce las fuerzas de corte al taladrar. El recubrimiento TiAlN mejora el rendimiento y prolonga la vida útil de la herramienta. Adecuada para taladrar muchos materiales.

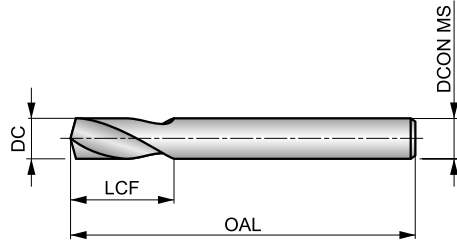

HM	DORMER	1xD
150°	TiAlN	
λ 20-35°	R	DC h6

Grupo de Material de la pieza adecuado y condiciones de velocidad de corte iniciales (m/min) y código de avance alfabético. Tablas con avance por revolución a partir de la pag.274.

P1.1 ■ 119 S	P1.2 ■ 134 S	P1.3 ■ 138 S	P2.1 ■ 102 S	P2.2 ■ 90 S	P2.3 ■ 80 S	P3.1 ■ 81 S	P3.2 ■ 65 S	P3.3 ■ 55 S	P4.1 ■ 48 S	P4.2 ■ 41 S	P4.3 ■ 34 S	M1.1 ■ 82 S	M1.2 ■ 70 S
M2.1 ■ 73 S	M2.2 ■ 60 S	M3.1 ■ 58 S	M3.2 ■ 50 S	K1.1 ■ 80 T	K1.2 ■ 59 T	K1.3 ■ 44 T	K2.1 ■ 86 T	K2.2 ■ 70 T	K2.3 ■ 56 T	K3.1 ■ 76 T	K3.2 ■ 58 T	K3.3 ■ 47 T	K4.1 ■ 71 T
K4.2 ■ 53 T	K4.3 ■ 39 T	K4.4 ■ 33 T	K4.5 ■ 28 T	K5.1 ■ 80 T	K5.2 ■ 60 T	K5.3 ■ 46 T	N1.1 ■ 200 V	N1.2 ■ 150 V	N1.3 ■ 100 V	N2.1 ■ 172 V	N2.2 ■ 155 V	N2.3 ■ 112 V	N3.1 ■ 423 V
N3.2 ■ 250 V	N3.3 ■ 125 V	N4.1 ■ 60 X	N4.2 ■ 100 V	S1.1 ■ 55 T	S1.2 ■ 45 T	S1.3 ■ 35 S	S2.1 ■ 53 S	S2.2 ■ 42 S	S3.1 ■ 40 S	S3.2 ■ 30 S	S4.1 ■ 31 S	S4.2 ■ 24 S	H1.1 ■ 56 S
H2.1 ■ 33 S	H2.2 ■ 36 S	H3.1 ■ 37 S	H3.2 ■ 30 S										

DCON MS tolerancia h6.

Product	DC (mm)	LCF (mm)	OAL (mm)	DCON MS (mm)
R1255.0	5.00	16.0	62.0	5.00
R1256.0	6.00	17.0	66.0	6.00
R1258.0	8.00	22.0	79.0	8.00
R12510.0	10.00	26.0	89.0	10.00
R12512.0	12.00	30.0	102.0	12.00
R12516.0	16.00	34.0	115.0	16.00

Código de Material (BMC)	HM	HM	HM	HM	HM	HM	HM	HM	HM	HM
Grupo básico estándar (BSG)	DIN 6539	DIN 338	DIN 6537K	DIN 6537K	DIN 6537L	DIN 6537L	DORMER	DIN 6537K	DIN 6537L	DORMER
Longitud Útil (ULDR)	2.5xD	4xD	3xD	3xD	5xD	5xD	8xD	3xD	5xD	3xD
Ángulo de aplicación	130°	130°	140°	140°	140°	140°	140°	140°	140°	90°
Recubrimiento	TiN	TiN	TiAlN	TiAlN	TiAlN	TiAlN	TiAlN	TiAlN	TiAlN	TiAlN
Mango			DIN 6535HA	DIN 6535HA	DIN 6535HA	DIN 6535HA	DIN 6535HA	DIN 6535HA	DIN 6535HA	DIN 6535HA
Forma de la Hélice	λ20-35°	λ20-35°	CTW	CTW	CTW	CTW	CTW	CTW	CTW	λ20-35°
Mano (dirección de corte)	R	R	R	R	R	R	R	R	R	R
Refrigeración (CSP)										
	CDX	CDX	FORCE X	FORCE X	FORCE X	FORCE X	FORCE X	FORCE M	FORCE M	

Código de Familia de Producto	R520	R510	R458	R457	R454	R453	R459	R467	R463	R7131
Gama de diámetros de corte PSF	3.00 - 16.50	3.00 - 14.00	3.00 - 20.00	3.00 - 20.00	3.00 - 20.00	3.00 - 20.00	3.00 - 16.00	3.00 - 16.00	3.00 - 16.00	3.30 - 10.40
	188	190	191	195	199	203	207	210	213	216

P	P1	■	■	■	■	■	■			■
	P2	■	■	■	■	■	■			■
	P3	■	■	■	■	■	■			■
	P4	■	■	■	■	■	■			■
M	M1	▣	▣	▣	▣	▣	▣	■	■	■
	M2	▣	▣	▣	▣	▣	▣	■	■	■
	M3			▣	▣	▣	▣	■	■	■
	M4			▣	▣	▣	▣	■	■	■
K	K1	■	■	■	■	■	■			■
	K2	■	■	■	■	■	■			■
	K3	■	■	■	■	■	■			■
	K4	■	■	■	■	■	■			■
	K5	■	■	■	■	■	■			■
N	N1	■	■	■	■	■	▣			■
	N2	■	■	■	■	■	■			■
	N3			■	■	■	▣			■
	N4	■	■							
	N5									
S	S1	▣	▣	▣	■	■		■	■	
	S2							▣	▣	
	S3							▣	▣	
	S4							▣	▣	
H	H1	▣	▣	■	■	■				
	H2	▣	▣	▣	▣	▣				
	H3	▣	▣	▣	▣	▣				
	H4									

R520



Broca CDX Metal Duro, Serie Extra Corta, con Recubrimiento TiN

Broca de alto rendimiento, capaz de producir agujeros precisos y de alta calidad a altas velocidades y avances (tolerancia de agujero H8). El ángulo de punta de 130° favorece el autocentrado y reduce las fuerzas de corte. El recubrimiento TiN mejora el rendimiento y prolonga la vida útil de la herramienta. Apto para todas las máquinas CNC y muchos materiales.

CDX

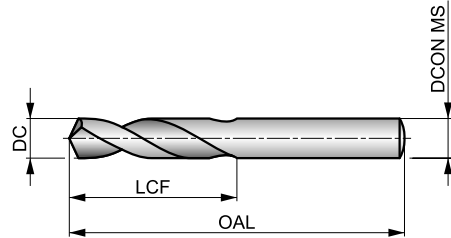

HM	DIN 6539	2.5xD
130°	TiN	
λ 20-35°	R	DC h7

Grupo de Material de la pieza adecuado y condiciones de velocidad de corte iniciales (m/min) y código de avance alfabético. Tablas con avance por revolución a partir de la pag.274.

P1.1 ■ 119 X	P1.2 ■ 134 X	P1.3 ■ 138 X	P2.1 ■ 102 X	P2.2 ■ 90 X	P2.3 ■ 80 X	P3.1 ■ 81 X	P3.2 ■ 65 X	P3.3 ■ 55 X	P4.1 ■ 48 X	P4.2 ■ 41 X	P4.3 ■ 34 W	M1.1 ■ 69 W	M1.2 ■ 58 W
M2.1 ■ 61 W	M2.2 ■ 50 W	K1.1 ■ 90 Y	K1.2 ■ 67 Y	K1.3 ■ 50 Y	K2.1 ■ 80 X	K2.2 ■ 65 X	K2.3 ■ 52 X	K3.1 ■ 71 X	K3.2 ■ 54 X	K3.3 ■ 44 X	K4.1 ■ 66 X	K4.2 ■ 49 X	K4.3 ■ 36 X
K4.4 ■ 31 X	K4.5 ■ 26 X	K5.1 ■ 74 X	K5.2 ■ 56 X	K5.3 ■ 43 X	N1.1 ■ 225 Z	N1.2 ■ 169 Z	N1.3 ■ 113 Z	N2.1 ■ 231 Y	N2.2 ■ 208 Y	N2.3 ■ 150 Y	N4.1 ■ 75 Z	N4.2 ■ 115 V	S1.1 ■ 60 W
S1.2 ■ 45 V	S1.3 ■ 35 U	H1.1 ■ 65 U	H2.1 ■ 38 U	H2.2 ■ 36 T	H3.1 ■ 43 U	H3.2 ■ 35 U							

DCON MS tolerancia h7.

Product	DC (inch)	DC (mm)	DC (inch)	LCF (mm)	OAL (mm)	DCON MS (mm)
R5203.0	–	3.00	0.1181	16.0	46.0	3.00
R5203.1	–	3.10	0.1220	18.0	49.0	3.10
R5201/8	1/8	3.18	0.1250	18.0	49.0	3.18
R5203.2	–	3.20	0.1260	18.0	49.0	3.20
R5203.3	–	3.30	0.1299	18.0	49.0	3.30
R5203.4	–	3.40	0.1339	20.0	52.0	3.40
R5203.5	–	3.50	0.1378	20.0	52.0	3.50
R5203.6	–	3.60	0.1417	20.0	52.0	3.60
R5203.7	–	3.70	0.1457	20.0	52.0	3.70
R5203.8	–	3.80	0.1496	22.0	55.0	3.80
R5203.9	–	3.90	0.1535	22.0	55.0	3.90
R5204.0	–	4.00	0.1575	22.0	55.0	4.00
R5204.1	–	4.10	0.1614	22.0	55.0	4.10
R5204.2	–	4.20	0.1654	22.0	55.0	4.20
R5204.3	–	4.30	0.1693	24.0	58.0	4.30
R5204.4	–	4.40	0.1732	24.0	58.0	4.40
R5204.5	–	4.50	0.1772	24.0	58.0	4.50
R5204.6	–	4.60	0.1811	24.0	58.0	4.60
R5204.7	–	4.70	0.1850	24.0	58.0	4.70
R5204.8	–	4.80	0.1890	26.0	62.0	4.80
R5204.9	–	4.90	0.1929	26.0	62.0	4.90
R5205.0	–	5.00	0.1969	26.0	62.0	5.00
R5205.1	–	5.10	0.2008	26.0	62.0	5.10
R5205.2	–	5.20	0.2047	26.0	62.0	5.20
R5205.3	–	5.30	0.2087	26.0	62.0	5.30

Product	DC (inch)	DC (mm)	DC (inch)	LCF (mm)	OAL (mm)	DCON MS (mm)
R5205.4	–	5.40	0.2126	28.0	66.0	5.40
R5205.5	–	5.50	0.2165	28.0	66.0	5.50
R5205.6	–	5.60	0.2205	28.0	66.0	5.60
R5205.8	–	5.80	0.2283	28.0	66.0	5.80
R5205.9	–	5.90	0.2323	28.0	66.0	5.90
R5206.0	–	6.00	0.2362	28.0	66.0	6.00
R5206.1	–	6.10	0.2402	31.0	70.0	6.10
R5206.2	–	6.20	0.2441	31.0	70.0	6.20
R5206.3	–	6.30	0.2480	31.0	70.0	6.30
R5201/4	1/4	6.35	0.2500	31.0	70.0	6.35
R5206.4	–	6.40	0.2520	31.0	70.0	6.40
R5206.5	–	6.50	0.2559	31.0	70.0	6.50
R5206.6	–	6.60	0.2598	31.0	70.0	6.60
R5206.7	–	6.70	0.2638	31.0	70.0	6.70
R5206.8	–	6.80	0.2677	34.0	74.0	6.80
R5206.9	–	6.90	0.2717	34.0	74.0	6.90
R5207.0	–	7.00	0.2756	34.0	74.0	7.00
R5207.1	–	7.10	0.2795	34.0	74.0	7.10
R5207.2	–	7.20	0.2835	34.0	74.0	7.20
R5207.3	–	7.30	0.2874	34.0	74.0	7.30
R5207.4	–	7.40	0.2913	34.0	74.0	7.40
R5207.5	–	7.50	0.2953	34.0	74.0	7.50
R5207.6	–	7.60	0.2992	37.0	79.0	7.60
R5207.7	–	7.70	0.3031	37.0	79.0	7.70
R5207.8	–	7.80	0.3071	37.0	79.0	7.80



Product	DC	DC	DC	LCF	OAL	DCON MS
	(inch)	(mm)	(inch)	(mm)	(mm)	(mm)
R5205/16	5/16	7.94	0.3126	37.0	79.0	7.94
R5208.0	–	8.00	0.3150	37.0	79.0	8.00
R5208.1	–	8.10	0.3189	37.0	79.0	8.10
R5208.2	–	8.20	0.3228	37.0	79.0	8.20
R5208.3	–	8.30	0.3268	37.0	79.0	8.30
R5208.4	–	8.40	0.3307	37.0	79.0	8.40
R5208.5	–	8.50	0.3346	37.0	79.0	8.50
R5208.6	–	8.60	0.3386	40.0	84.0	8.60
R5208.7	–	8.70	0.3425	40.0	84.0	8.70
R5208.8	–	8.80	0.3465	40.0	84.0	8.80
R5209.0	–	9.00	0.3543	40.0	84.0	9.00
R5209.1	–	9.10	0.3583	40.0	84.0	9.10
R5209.3	–	9.30	0.3661	40.0	84.0	9.30
R5209.5	–	9.50	0.3740	40.0	84.0	9.50
R5203/8	3/8	9.52	0.3748	43.0	89.0	9.52
R5209.6	–	9.60	0.3780	43.0	89.0	9.60
R5209.7	–	9.70	0.3819	43.0	89.0	9.70
R5209.8	–	9.80	0.3858	43.0	89.0	9.80
R52010.0	–	10.00	0.3937	43.0	89.0	10.00
R52010.1	–	10.10	0.3976	43.0	89.0	10.10
R52010.2	–	10.20	0.4016	43.0	89.0	10.20

Product	DC	DC	DC	LCF	OAL	DCON MS
	(inch)	(mm)	(inch)	(mm)	(mm)	(mm)
R52010.3	–	10.30	0.4055	43.0	89.0	10.30
R52010.4	–	10.40	0.4094	43.0	89.0	10.40
R52010.5	–	10.50	0.4134	43.0	89.0	10.50
R52011.0	–	11.00	0.4331	47.0	95.0	11.00
R5207/16	7/16	11.11	0.4374	47.0	95.0	11.11
R52011.2	–	11.20	0.4409	47.0	95.0	11.20
R52011.5	–	11.50	0.4528	47.0	95.0	11.50
R52012.0	–	12.00	0.4724	51.0	102.0	12.00
R52012.5	–	12.50	0.4921	51.0	102.0	12.50
R5201/2	1/2	12.70	0.5000	51.0	102.0	12.70
R52013.0	–	13.00	0.5118	51.0	102.0	13.00
R52013.5	–	13.50	0.5315	54.0	107.0	13.50
R52014.0	–	14.00	0.5512	54.0	107.0	14.00
R52014.2	–	14.20	0.5591	56.0	111.0	14.20
R52014.25	–	14.25	0.5610	56.0	111.0	14.25
R52014.5	–	14.50	0.5709	56.0	111.0	14.50
R52015.0	–	15.00	0.5906	56.0	111.0	15.00
R52015.1	–	15.10	0.5945	58.0	115.0	15.10
R5205/8	5/8	15.88	0.6252	58.0	115.0	15.88
R52016.0	–	16.00	0.6299	58.0	115.0	16.00
R52016.5	–	16.50	0.6496	60.0	119.0	16.50

R510



Broca CDX Metal Duro, Serie Corta, con Recubrimiento TiN

Broca de alto rendimiento, capaz de producir agujeros precisos y de alta calidad a altas velocidades y avances (tolerancia de agujero H8). La punta a 130° facilita el auto-centrado y reduce las fuerzas de corte. El recubrimiento TiN mejora el rendimiento y prolonga la vida de la herramienta. Adecuada para todas las máquinas CNC y para la mayoría de materiales.

CDX

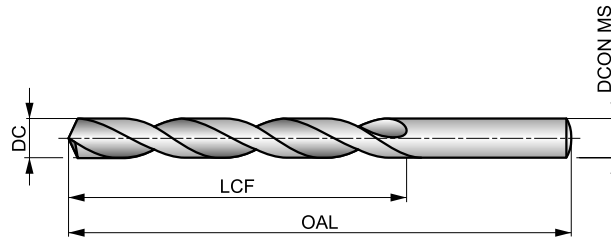

HM	DIN 338	4×D
130°	TiN	
λ 20-35°	R	DC h7

Grupo de Material de la pieza adecuado y condiciones de velocidad de corte iniciales (m/min) y código de avance alfabético. Tablas con avance por revolución a partir de la pag.274.

P1.1 ■ 119 W	P1.2 ■ 134 W	P1.3 ■ 138 W	P2.1 ■ 102 W	P2.2 ■ 90 W	P2.3 ■ 80 V	P3.1 ■ 81 W	P3.2 ■ 65 W	P3.3 ■ 55 V	P4.1 ■ 48 W	P4.2 ■ 41 V	P4.3 ■ 34 V	M1.1 ■ 69 V	M1.2 ■ 58 V
M2.1 ■ 61 V	M2.2 ■ 50 V	K1.1 ■ 90 X	K1.2 ■ 67 X	K1.3 ■ 50 X	K2.1 ■ 80 W	K2.2 ■ 65 W	K2.3 ■ 52 W	K3.1 ■ 71 W	K3.2 ■ 54 W	K3.3 ■ 44 W	K4.1 ■ 66 W	K4.2 ■ 49 W	K4.3 ■ 36 W
K4.4 ■ 31 W	K4.5 ■ 26 W	K5.1 ■ 74 W	K5.2 ■ 56 W	K5.3 ■ 43 W	N1.1 ■ 225 Y	N1.2 ■ 169 Y	N1.3 ■ 113 Y	N2.1 ■ 231 X	N2.2 ■ 208 X	N2.3 ■ 150 X	N4.1 ■ 75 X	N4.2 ■ 115 V	S1.1 ■ 45 V
H1.1 ■ 65 T	H2.1 ■ 38 T	H2.2 ■ 36 S	H3.1 ■ 43 T	H3.2 ■ 35 T									

DCON MS tolerancia h7.

Product	DC (inch)	DC (mm)	DC (inch)	LCF (mm)	OAL (mm)	DCON MS (mm)
R5103.0	-	3.00	0.1181	33.0	61.0	3.00
R5101/8	1/8	3.18	0.1250	36.0	65.0	3.18
R5103.2	-	3.20	0.1260	36.0	65.0	3.20
R5103.3	-	3.30	0.1299	36.0	65.0	3.30
R5103.4	-	3.40	0.1339	39.0	70.0	3.40
R5103.5	-	3.50	0.1378	39.0	70.0	3.50
R5103.7	-	3.70	0.1457	39.0	70.0	3.70
R5103.9	-	3.90	0.1535	43.0	75.0	3.90
R5104.0	-	4.00	0.1575	43.0	75.0	4.00
R5104.1	-	4.10	0.1614	43.0	75.0	4.10
R5104.2	-	4.20	0.1654	43.0	75.0	4.20
R5104.3	-	4.30	0.1693	47.0	80.0	4.30
R5104.5	-	4.50	0.1772	47.0	80.0	4.50
R5104.7	-	4.70	0.1850	47.0	80.0	4.70
R5103/16	3/16	4.76	0.1874	52.0	86.0	4.76
R5104.9	-	4.90	0.1929	52.0	86.0	4.90
R5105.0	-	5.00	0.1969	52.0	86.0	5.00
R5105.1	-	5.10	0.2008	52.0	86.0	5.10
R5105.5	-	5.50	0.2165	57.0	93.0	5.50
R5105.6	-	5.60	0.2205	57.0	93.0	5.60
R5105.7	-	5.70	0.2244	57.0	93.0	5.70
R5106.0	-	6.00	0.2362	57.0	93.0	6.00
R5101/4	1/4	6.35	0.2500	63.0	101.0	6.35
R5106.5	-	6.50	0.2559	63.0	101.0	6.50
R5106.6	-	6.60	0.2598	63.0	101.0	6.60
R5106.8	-	6.80	0.2677	69.0	109.0	6.80
R5107.0	-	7.00	0.2756	69.0	109.0	7.00
R5107.3	-	7.30	0.2874	69.0	109.0	7.30

Product	DC (inch)	DC (mm)	DC (inch)	LCF (mm)	OAL (mm)	DCON MS (mm)
R5107.4	-	7.40	0.2913	69.0	109.0	7.40
R5107.5	-	7.50	0.2953	69.0	109.0	7.50
R5107.8	-	7.80	0.3071	75.0	117.0	7.80
R5105/16	5/16	7.94	0.3126	75.0	117.0	7.94
R5108.0	-	8.00	0.3150	75.0	117.0	8.00
R5108.5	-	8.50	0.3346	75.0	117.0	8.50
R5108.7	-	8.70	0.3425	81.0	125.0	8.70
R5108.8	-	8.80	0.3465	81.0	125.0	8.80
R5109.0	-	9.00	0.3543	81.0	125.0	9.00
R5109.2	-	9.20	0.3622	81.0	125.0	9.20
R5109.3	-	9.30	0.3661	81.0	125.0	9.30
R5109.5	-	9.50	0.3740	81.0	125.0	9.50
R5103/8	3/8	9.52	0.3748	87.0	133.0	9.52
R5109.9	-	9.90	0.3898	87.0	133.0	9.90
R51010.0	-	10.00	0.3937	87.0	133.0	10.00
R51010.2	-	10.20	0.4016	87.0	133.0	10.20
R51010.3	-	10.30	0.4055	87.0	133.0	10.30
R51010.4	-	10.40	0.4094	87.0	133.0	10.40
R51010.5	-	10.50	0.4134	87.0	133.0	10.50
R51010.8	-	10.80	0.4252	94.0	142.0	10.80
R51011.0	-	11.00	0.4331	94.0	142.0	11.00
R5107/16	7/16	11.11	0.4374	94.0	142.0	11.11
R51011.2	-	11.20	0.4409	94.0	142.0	11.20
R51011.5	-	11.50	0.4528	94.0	142.0	11.50
R51012.0	-	12.00	0.4724	101.0	151.0	12.00
R5101/2	1/2	12.70	0.5000	101.0	151.0	12.70
R51013.0	-	13.00	0.5118	101.0	151.0	13.00
R51014.0	-	14.00	0.5512	108.0	160.0	14.00

R458



Broca FORCE X, Metal Duro 3XD, con Recubrimiento TiAlN

Broca de alto rendimiento, capaz de producir agujeros precisos y de alta calidad a altas velocidades y avances (tolerancia de agujero H9). Punta dividida de 4 facetas a 140° y alma continuamente adelgazada (CTW) para mejorar los índices de penetración. El recubrimiento TiAlN aumenta la dureza superficial y prolonga la vida de la herramienta.

FORCE X

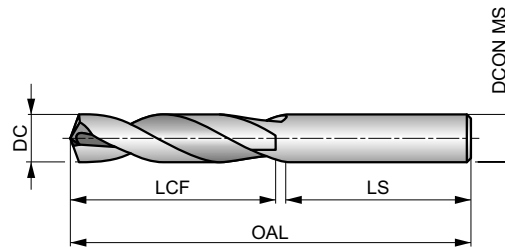

HM	DIN 6537K	3xD
140°	TiAlN	DIN 6535HA
CTW	R	DC m7

Grupo de Material de la pieza adecuado y condiciones de velocidad de corte iniciales (m/min) y código de avance alfabético. Tablas con avance por revolución a partir de la pag.274.

P1.1 ■ 143 W	P1.2 ■ 160 W	P1.3 ■ 166 W	P2.1 ■ 122 W	P2.2 ■ 108 W	P2.3 ■ 95 V	P3.1 ■ 106 V	P3.2 ■ 86 V	P3.3 ■ 72 V	P4.1 ■ 63 V	P4.2 ■ 54 V	P4.3 ■ 44 U	M1.1 □ 60 U	M1.2 □ 51 U
M2.1 □ 54 U	M2.2 □ 44 U	M2.3 □ 37 T	M3.1 □ 33 T	M3.2 □ 28 T	M3.3 □ 26 T	M4.1 □ 24 T	M4.2 □ 21 T	K1.1 ■ 88 W	K1.2 ■ 65 W	K1.3 ■ 49 W	K2.1 ■ 78 V	K2.2 ■ 64 V	K2.3 ■ 51 V
K3.1 ■ 70 V	K3.2 ■ 54 V	K3.3 ■ 43 V	K4.1 ■ 65 V	K4.2 ■ 49 V	K4.3 ■ 36 V	K4.4 ■ 30 V	K4.5 ■ 26 V	K5.1 ■ 73 V	K5.2 ■ 55 V	K5.3 ■ 42 V	N1.1 ■ 200 W	N1.2 ■ 150 W	N1.3 ■ 100 W
N2.1 ■ 246 V	N2.2 ■ 222 V	N2.3 ■ 160 V	N3.1 ■ 298 V	N3.2 ■ 176 V	N3.3 ■ 88 V	S1.1 □ 44 U	S1.2 □ 36 U	S1.3 □ 32 T	H1.1 ■ 45 U	H2.1 □ 26 U	H2.2 □ 24 U	H3.1 □ 30 U	H3.2 □ 24 U

DCON MS tolerancia h6.

Product	DC (inch)	DC (mm)	DC (inch)	LCF (mm)	OAL (mm)	LS (mm)	DCON MS (mm)
R4583.0	-	3.00	0.1181	20.0	62.0	36.0	6.00
R4583.1	-	3.10	0.1220	20.0	62.0	36.0	6.00
R4581/8	1/8	3.18	0.1250	20.0	62.0	36.0	6.00
R4583.2	-	3.20	0.1260	20.0	62.0	36.0	6.00
R458N30	N30	3.26	0.1283	20.0	62.0	36.0	6.00
R4583.3	-	3.30	0.1299	20.0	62.0	36.0	6.00
R4583.4	-	3.40	0.1339	20.0	62.0	36.0	6.00
R458N29	N29	3.45	0.1360	20.0	62.0	36.0	6.00
R4583.5	-	3.50	0.1378	20.0	62.0	36.0	6.00
R458N28	N28	3.57	0.1406	20.0	62.0	36.0	6.00
R4589/64	9/64	3.57	0.1406	20.0	62.0	36.0	6.00
R4583.6	-	3.60	0.1417	20.0	62.0	36.0	6.00
R458N27	N27	3.66	0.1441	20.0	62.0	36.0	6.00
R4583.7	-	3.70	0.1457	20.0	62.0	36.0	6.00
R4583.73	-	3.73	0.1469	24.0	66.0	36.0	6.00
R458N26	N26	3.73	0.1469	24.0	66.0	36.0	6.00
R458N25	N25	3.80	0.1496	24.0	66.0	36.0	6.00
R4583.8	-	3.80	0.1496	24.0	66.0	36.0	6.00
R458N24	N24	3.86	0.1520	24.0	66.0	36.0	6.00
R4583.9	-	3.90	0.1535	24.0	66.0	36.0	6.00
R458N23	N23	3.91	0.1539	24.0	66.0	36.0	6.00
R4585/32	5/32	3.97	0.1563	24.0	66.0	36.0	6.00
R458N22	N22	3.99	0.1571	24.0	66.0	36.0	6.00
R4584.0	-	4.00	0.1575	24.0	66.0	36.0	6.00
R458N21	N21	4.04	0.1591	24.0	66.0	36.0	6.00

Product	DC	DC	DC	LCF	OAL	LS	DCON MS
	(inch)	(mm)	(inch)	(mm)	(mm)	(mm)	(mm)
R458N20	N20	4.09	0.1610	24.0	66.0	36.0	6.00
R4584.1	–	4.10	0.1614	24.0	66.0	36.0	6.00
R4584.2	–	4.20	0.1654	24.0	66.0	36.0	6.00
R458N19	N19	4.22	0.1661	24.0	66.0	36.0	6.00
R4584.3	–	4.30	0.1693	24.0	66.0	36.0	6.00
R458N18	N18	4.31	0.1697	24.0	66.0	36.0	6.00
R45811/64	11/64	4.37	0.1719	24.0	66.0	36.0	6.00
R458N17	N17	4.39	0.1728	24.0	66.0	36.0	6.00
R4584.4	–	4.40	0.1732	24.0	66.0	36.0	6.00
R4584.5	–	4.50	0.1772	24.0	66.0	36.0	6.00
R458N16	N16	4.50	0.1772	24.0	66.0	36.0	6.00
R458N15	N15	4.57	0.1799	24.0	66.0	36.0	6.00
R4584.6	–	4.60	0.1811	24.0	66.0	36.0	6.00
R458N14	N14	4.62	0.1819	24.0	66.0	36.0	6.00
R458N13	N13	4.70	0.1850	24.0	66.0	36.0	6.00
R4584.7	–	4.70	0.1850	24.0	66.0	36.0	6.00
R4583/16	3/16	4.76	0.1875	28.0	66.0	36.0	6.00
R4584.8	–	4.80	0.1890	28.0	66.0	36.0	6.00
R458N12	N12	4.80	0.1890	28.0	66.0	36.0	6.00
R458N11	N11	4.85	0.1909	28.0	66.0	36.0	6.00
R4584.9	–	4.90	0.1929	28.0	66.0	36.0	6.00
R458N10	N10	4.92	0.1937	28.0	66.0	36.0	6.00
R458N9	N9	4.98	0.1961	28.0	66.0	36.0	6.00
R4585.0	–	5.00	0.1969	28.0	66.0	36.0	6.00
R458N8	N8	5.06	0.1992	28.0	66.0	36.0	6.00
R4585.1	–	5.10	0.2008	28.0	66.0	36.0	6.00
R458N7	N7	5.11	0.2010	28.0	66.0	36.0	6.00
R45813/64	13/64	5.16	0.2031	28.0	66.0	36.0	6.00
R458N6	N6	5.18	0.2039	28.0	66.0	36.0	6.00
R4585.2	–	5.20	0.2047	28.0	66.0	36.0	6.00
R458N5	N5	5.22	0.2055	28.0	66.0	36.0	6.00
R4585.3	–	5.30	0.2087	28.0	66.0	36.0	6.00
R458N4	N4	5.31	0.2091	28.0	66.0	36.0	6.00
R4585.4	–	5.40	0.2126	28.0	66.0	36.0	6.00
R458N3	N3	5.41	0.2130	28.0	66.0	36.0	6.00
R4585.5	–	5.50	0.2165	28.0	66.0	36.0	6.00
R4587/32	7/32	5.56	0.2188	28.0	66.0	36.0	6.00
R4585.6	–	5.60	0.2205	28.0	66.0	36.0	6.00
R458N2	N2	5.61	0.2209	28.0	66.0	36.0	6.00
R4585.7	–	5.70	0.2244	28.0	66.0	36.0	6.00
R458N1	N1	5.79	0.2280	28.0	66.0	36.0	6.00
R4585.8	–	5.80	0.2283	28.0	66.0	36.0	6.00
R4585.9	–	5.90	0.2323	28.0	66.0	36.0	6.00
R45815/64	15/64	5.95	0.2344	28.0	66.0	36.0	6.00
R4586.0	–	6.00	0.2362	28.0	66.0	36.0	6.00
R458B	B	6.05	0.2380	34.0	79.0	36.0	8.00
R4586.1	–	6.10	0.2402	34.0	79.0	36.0	8.00
R458C	C	6.15	0.2421	34.0	79.0	36.0	8.00
R4586.2	–	6.20	0.2441	34.0	79.0	36.0	8.00
R458D	D	6.25	0.2461	34.0	79.0	36.0	8.00
R4586.3	–	6.30	0.2480	34.0	79.0	36.0	8.00
R4581/4	1/4	6.35	0.2500	34.0	79.0	36.0	8.00
R4586.4	–	6.40	0.2520	34.0	79.0	36.0	8.00
R4586.5	–	6.50	0.2559	34.0	79.0	36.0	8.00
R458F	F	6.53	0.2571	34.0	79.0	36.0	8.00
R4586.6	–	6.60	0.2598	34.0	79.0	36.0	8.00
R458G	G	6.63	0.2610	34.0	79.0	36.0	8.00
R4586.7	–	6.70	0.2638	34.0	79.0	36.0	8.00
R45817/64	17/64	6.75	0.2656	34.0	79.0	36.0	8.00
R458H	H	6.76	0.2661	34.0	79.0	36.0	8.00
R4586.8	–	6.80	0.2677	34.0	79.0	36.0	8.00
R4586.9	–	6.90	0.2717	34.0	79.0	36.0	8.00



Product	DC	DC	DC	LCF	OAL	LS	DCON MS
	(inch)	(mm)	(inch)	(mm)	(mm)	(mm)	(mm)
R458I	I	6.91	0.2720	34.0	79.0	36.0	8.00
R4587.0	–	7.00	0.2756	34.0	79.0	36.0	8.00
R458J	J	7.04	0.2772	34.0	79.0	36.0	8.00
R4587.1	–	7.10	0.2795	41.0	79.0	36.0	8.00
R4589/32	9/32	7.14	0.2813	41.0	79.0	36.0	8.00
R4587.2	–	7.20	0.2835	41.0	79.0	36.0	8.00
R4587.3	–	7.30	0.2874	41.0	79.0	36.0	8.00
R458L	L	7.37	0.2902	41.0	79.0	36.0	8.00
R4587.4	–	7.40	0.2913	41.0	79.0	36.0	8.00
R4587.5	–	7.50	0.2953	41.0	79.0	36.0	8.00
R45819/64	19/64	7.54	0.2969	41.0	79.0	36.0	8.00
R4587.6	–	7.60	0.2992	41.0	79.0	36.0	8.00
R458N	N	7.67	0.3020	41.0	79.0	36.0	8.00
R4587.7	–	7.70	0.3031	41.0	79.0	36.0	8.00
R4587.8	–	7.80	0.3071	41.0	79.0	36.0	8.00
R4587.9	–	7.90	0.3110	41.0	79.0	36.0	8.00
R4585/16	5/16	7.94	0.3125	41.0	79.0	36.0	8.00
R4588.0	–	8.00	0.3150	41.0	79.0	36.0	8.00
R4580	O	8.03	0.3161	47.0	89.0	40.0	10.00
R4588.1	–	8.10	0.3189	47.0	89.0	40.0	10.00
R4588.2	–	8.20	0.3228	47.0	89.0	40.0	10.00
R4588.3	–	8.30	0.3268	47.0	89.0	40.0	10.00
R45821/64	21/64	8.33	0.3281	47.0	89.0	40.0	10.00
R4588.4	–	8.40	0.3307	47.0	89.0	40.0	10.00
R458Q	Q	8.43	0.3319	47.0	89.0	40.0	10.00
R4588.5	–	8.50	0.3346	47.0	89.0	40.0	10.00
R4588.6	–	8.60	0.3386	47.0	89.0	40.0	10.00
R458R	R	8.61	0.3390	47.0	89.0	40.0	10.00
R4588.7	–	8.70	0.3425	47.0	89.0	40.0	10.00
R45811/32	11/32	8.73	0.3438	47.0	89.0	40.0	10.00
R4588.8	–	8.80	0.3465	47.0	89.0	40.0	10.00
R458S	S	8.84	0.3480	47.0	89.0	40.0	10.00
R4588.9	–	8.90	0.3504	47.0	89.0	40.0	10.00
R4589.0	–	9.00	0.3543	47.0	89.0	40.0	10.00
R458T	T	9.09	0.3579	47.0	89.0	40.0	10.00
R4589.1	–	9.10	0.3583	47.0	89.0	40.0	10.00
R45823/64	23/64	9.13	0.3594	47.0	89.0	40.0	10.00
R4589.2	–	9.20	0.3622	47.0	89.0	40.0	10.00
R4589.3	–	9.30	0.3661	47.0	89.0	40.0	10.00
R458U	U	9.35	0.3681	47.0	89.0	40.0	10.00
R4589.4	–	9.40	0.3701	47.0	89.0	40.0	10.00
R4589.5	–	9.50	0.3740	47.0	89.0	40.0	10.00
R4583/8	3/8	9.53	0.3750	47.0	89.0	40.0	10.00
R458V	V	9.58	0.3772	47.0	89.0	40.0	10.00
R4589.6	–	9.60	0.3780	47.0	89.0	40.0	10.00
R4589.7	–	9.70	0.3819	47.0	89.0	40.0	10.00
R4589.8	–	9.80	0.3858	47.0	89.0	40.0	10.00
R4589.9	–	9.90	0.3898	47.0	89.0	40.0	10.00
R45825/64	25/64	9.92	0.3906	47.0	89.0	40.0	10.00
R45810.0	–	10.00	0.3937	47.0	89.0	40.0	10.00
R458X	X	10.08	0.3969	55.0	102.0	45.0	12.00
R45810.1	–	10.10	0.3976	55.0	102.0	45.0	12.00
R45810.2	–	10.20	0.4016	55.0	102.0	45.0	12.00
R458Y	Y	10.26	0.4039	55.0	102.0	45.0	12.00
R45810.3	–	10.30	0.4055	55.0	102.0	45.0	12.00
R45813/32	13/32	10.32	0.4063	55.0	102.0	45.0	12.00
R45810.4	–	10.40	0.4094	55.0	102.0	45.0	12.00
R45810.5	–	10.50	0.4134	55.0	102.0	45.0	12.00
R45810.6	–	10.60	0.4173	55.0	102.0	45.0	12.00
R45810.7	–	10.70	0.4213	55.0	102.0	45.0	12.00
R45827/64	27/64	10.72	0.4219	55.0	102.0	45.0	12.00
R45810.8	–	10.80	0.4252	55.0	102.0	45.0	12.00

Product	DC	DC	DC	LCF	OAL	LS	DCON MS
	(inch)	(mm)	(inch)	(mm)	(mm)	(mm)	(mm)
R45810.9	–	10.90	0.4291	55.0	102.0	45.0	12.00
R45811.0	–	11.00	0.4331	55.0	102.0	45.0	12.00
R45811.1	–	11.10	0.4370	55.0	102.0	45.0	12.00
R4587/16	7/16	11.11	0.4375	55.0	102.0	45.0	12.00
R45811.2	–	11.20	0.4409	55.0	102.0	45.0	12.00
R45811.3	–	11.30	0.4449	55.0	102.0	45.0	12.00
R45811.4	–	11.40	0.4488	55.0	102.0	45.0	12.00
R45811.5	–	11.50	0.4528	55.0	102.0	45.0	12.00
R45829/64	29/64	11.51	0.4531	55.0	102.0	45.0	12.00
R45811.6	–	11.60	0.4567	55.0	102.0	45.0	12.00
R45811.7	–	11.70	0.4606	55.0	102.0	45.0	12.00
R45811.8	–	11.80	0.4646	55.0	102.0	45.0	12.00
R45811.9	–	11.90	0.4685	55.0	102.0	45.0	12.00
R45815/32	15/32	11.91	0.4688	55.0	102.0	45.0	12.00
R45812.0	–	12.00	0.4724	55.0	102.0	45.0	12.00
R45812.1	–	12.10	0.4764	60.0	107.0	45.0	14.00
R45812.2	–	12.20	0.4803	60.0	107.0	45.0	14.00
R45831/64	31/64	12.30	0.4844	60.0	107.0	45.0	14.00
R45812.5	–	12.50	0.4921	60.0	107.0	45.0	14.00
R45812.7	–	12.70	0.5000	60.0	107.0	45.0	14.00
R4581/2	1/2	12.70	0.5000	60.0	107.0	45.0	14.00
R45812.8	–	12.80	0.5039	60.0	107.0	45.0	14.00
R45813.0	–	13.00	0.5118	60.0	107.0	45.0	14.00
R45833/64	33/64	13.10	0.5156	60.0	107.0	45.0	14.00
R45813.3	–	13.30	0.5236	60.0	107.0	45.0	14.00
R45817/32	17/32	13.49	0.5313	60.0	107.0	45.0	14.00
R45813.5	–	13.50	0.5315	60.0	107.0	45.0	14.00
R45813.8	–	13.80	0.5433	60.0	107.0	45.0	14.00
R45835/64	35/64	13.89	0.5469	60.0	107.0	45.0	14.00
R45814.0	–	14.00	0.5512	60.0	107.0	45.0	14.00
R45814.25	–	14.25	0.5610	65.0	115.0	48.0	16.00
R4589/16	9/16	14.29	0.5625	65.0	115.0	48.0	16.00
R45814.5	–	14.50	0.5709	65.0	115.0	48.0	16.00
R45837/64	37/64	14.68	0.5781	65.0	115.0	48.0	16.00
R45814.8	–	14.80	0.5827	65.0	115.0	48.0	16.00
R45815.0	–	15.00	0.5906	65.0	115.0	48.0	16.00
R45819/32	19/32	15.08	0.5938	65.0	115.0	48.0	16.00
R45815.1	–	15.10	0.5945	65.0	115.0	48.0	16.00
R45815.3	–	15.30	0.6024	65.0	115.0	48.0	16.00
R45839/64	39/64	15.48	0.6094	65.0	115.0	48.0	16.00
R45815.5	–	15.50	0.6102	65.0	115.0	48.0	16.00
R45815.8	–	15.80	0.6220	65.0	115.0	48.0	16.00
R4585/8	5/8	15.88	0.6250	65.0	115.0	48.0	16.00
R45816.0	–	16.00	0.6299	65.0	115.0	48.0	16.00
R45841/64	41/64	16.27	0.6406	73.0	123.0	48.0	18.00
R45816.5	–	16.50	0.6496	73.0	123.0	48.0	18.00
R45821/32	21/32	16.67	0.6563	73.0	123.0	48.0	18.00
R45817.0	–	17.00	0.6693	73.0	123.0	48.0	18.00
R45843/64	43/64	17.07	0.6720	73.0	123.0	48.0	18.00
R45811/16	11/16	17.46	0.6874	73.0	123.0	48.0	18.00
R45817.5	–	17.50	0.6890	73.0	123.0	48.0	18.00
R45817.8	–	17.80	0.7008	73.0	123.0	48.0	18.00
R45845/64	45/64	17.86	0.7031	73.0	123.0	48.0	18.00
R45818.0	–	18.00	0.7087	73.0	123.0	48.0	18.00
R45823/32	23/32	18.26	0.7189	79.0	131.0	50.0	20.00
R45818.5	–	18.50	0.7283	79.0	131.0	50.0	20.00
R45847/64	47/64	18.65	0.7343	79.0	131.0	50.0	20.00
R45819.0	–	19.00	0.7480	79.0	131.0	50.0	20.00
R4583/4	–	19.05	0.7500	79.0	131.0	50.0	20.00
R45819.5	–	19.50	0.7677	79.0	131.0	50.0	20.00
R45819.8	–	19.80	0.7795	79.0	131.0	50.0	20.00
R45820.0	–	20.00	0.7874	79.0	131.0	50.0	20.00

R457



Broca FORCE X, Metal Duro 3XD, con Refrigeración Interna, con Recubrimiento TiAIN

Broca de alto rendimiento, capaz de producir agujeros precisos y de alta calidad a altas velocidades y avances (tolerancia de agujero H9). Punta dividida de 4 facetas a 140 ° y alma continuamente adelgazada (CTW) para mejorar los índices de penetración. Los agujeros de refrigeración permiten mejorar la evacuación de virutas. El recubrimiento TiAIN aumenta la dureza superficial y prolonga la vida de la herramienta.

FORCE X

HM	DIN 6537K	3xD
140°	TiAIN	DIN 6535HA
CTW	R	
DC m7		

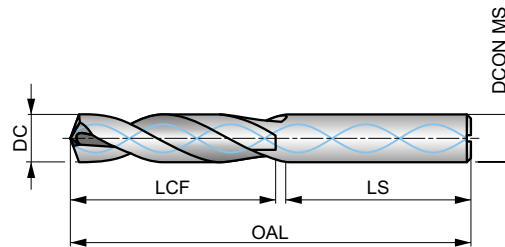

Grupo de Material de la pieza adecuado y condiciones de velocidad de corte iniciales (m/min) y código de avance alfabético. Tablas con avance por revolución a partir de la pag.274.

P1.1 ■ 179 W	P1.2 ■ 200 W	P1.3 ■ 207 W	P2.1 ■ 153 W	P2.2 ■ 135 W	P2.3 ■ 119 V	P3.1 ■ 133 V	P3.2 ■ 107 V	P3.3 ■ 90 V	P4.1 ■ 79 V	P4.2 ■ 67 V	P4.3 ■ 55 U	M1.1 ▣ 75 V	M1.2 ▣ 64 V
M2.1 ▣ 67 V	M2.2 ▣ 55 V	M2.3 ▣ 46 U	M3.1 ▣ 41 V	M3.2 ▣ 35 V	M3.3 ▣ 32 V	M4.1 ▣ 30 U	M4.2 ▣ 26 U	K1.1 ■ 110 W	K1.2 ■ 81 W	K1.3 ■ 61 W	K2.1 ■ 98 V	K2.2 ■ 80 V	K2.3 ■ 64 V
K3.1 ■ 87 V	K3.2 ■ 67 V	K3.3 ■ 54 V	K4.1 ■ 81 V	K4.2 ■ 61 V	K4.3 ■ 45 V	K4.4 ■ 38 V	K4.5 ■ 32 V	K5.1 ■ 91 V	K5.2 ■ 69 V	K5.3 ■ 53 V	N1.1 ■ 250 W	N1.2 ■ 188 W	N1.3 ■ 125 W
N2.1 ■ 308 V	N2.2 ■ 277 V	N2.3 ■ 200 V	N3.1 ■ 373 W	N3.2 ■ 220 W	N3.3 ■ 110 W	S1.1 ■ 55 V	S1.2 ■ 45 V	S1.3 ■ 40 U	H1.1 ■ 56 U	H2.1 ▣ 33 U	H2.2 ▣ 30 U	H3.1 ▣ 37 U	H3.2 ▣ 30 U

DCON MS tolerancia h6.

Product	DC (inch)	DC (mm)	DC (inch)	LCF (mm)	OAL (mm)	LS (mm)	DCON MS (mm)
R4573.0	–	3.00	0.1181	20.0	62.0	36.0	6.00
R4573.1	–	3.10	0.1220	20.0	62.0	36.0	6.00
R4571/8	1/8	3.18	0.1250	20.0	62.0	36.0	6.00
R4573.2	–	3.20	0.1260	20.0	62.0	36.0	6.00
R457N30	N30	3.26	0.1283	20.0	62.0	36.0	6.00
R4573.3	–	3.30	0.1299	20.0	62.0	36.0	6.00
R4573.4	–	3.40	0.1339	20.0	62.0	36.0	6.00
R457N29	N29	3.45	0.1360	20.0	62.0	36.0	6.00
R4573.5	–	3.50	0.1378	20.0	62.0	36.0	6.00
R457N28	N28	3.57	0.1406	20.0	62.0	36.0	6.00
R4579/64	9/64	3.57	0.1406	20.0	62.0	36.0	6.00
R4573.6	–	3.60	0.1417	20.0	62.0	36.0	6.00
R457N27	N27	3.66	0.1441	20.0	62.0	36.0	6.00
R4573.7	–	3.70	0.1457	20.0	62.0	36.0	6.00
R457N26	N26	3.73	0.1469	24.0	66.0	36.0	6.00
R457N25	N25	3.80	0.1496	24.0	66.0	36.0	6.00
R4573.8	–	3.80	0.1496	24.0	66.0	36.0	6.00
R457N24	N24	3.86	0.1520	24.0	66.0	36.0	6.00
R4573.9	–	3.90	0.1535	24.0	66.0	36.0	6.00
R457N23	N23	3.91	0.1539	24.0	66.0	36.0	6.00
R4575/32	5/32	3.97	0.1563	24.0	66.0	36.0	6.00
R457N22	N22	3.99	0.1571	24.0	66.0	36.0	6.00
R4574.0	–	4.00	0.1575	24.0	66.0	36.0	6.00
R457N21	N21	4.04	0.1591	24.0	66.0	36.0	6.00
R4574.05	–	4.05	0.1594	24.0	66.0	36.0	6.00

Product	DC	DC	DC	LCF	OAL	LS	DCON MS
	(inch)	(mm)	(inch)	(mm)	(mm)	(mm)	(mm)
R457N20	N20	4.09	0.1610	24.0	66.0	36.0	6.00
R4574.1	–	4.10	0.1614	24.0	66.0	36.0	6.00
R4574.2	–	4.20	0.1654	24.0	66.0	36.0	6.00
R4574.3	–	4.30	0.1693	24.0	66.0	36.0	6.00
R457N18	N18	4.31	0.1697	24.0	66.0	36.0	6.00
R45711/64	11/64	4.37	0.1719	24.0	66.0	36.0	6.00
R457N17	N17	4.39	0.1728	24.0	66.0	36.0	6.00
R4574.4	–	4.40	0.1732	24.0	66.0	36.0	6.00
R4574.5	–	4.50	0.1772	24.0	66.0	36.0	6.00
R457N16	N16	4.50	0.1772	24.0	66.0	36.0	6.00
R457N15	N15	4.57	0.1799	24.0	66.0	36.0	6.00
R4574.6	–	4.60	0.1811	24.0	66.0	36.0	6.00
R457N14	N14	4.62	0.1819	24.0	66.0	36.0	6.00
R4574.7	–	4.70	0.1850	24.0	66.0	36.0	6.00
R4573/16	3/16	4.76	0.1875	28.0	66.0	36.0	6.00
R4574.8	–	4.80	0.1890	28.0	66.0	36.0	6.00
R457N11	N11	4.85	0.1909	28.0	66.0	36.0	6.00
R4574.9	–	4.90	0.1929	28.0	66.0	36.0	6.00
R457N9	N9	4.98	0.1961	28.0	66.0	36.0	6.00
R4575.0	–	5.00	0.1969	28.0	66.0	36.0	6.00
R4575.05	–	5.05	0.1988	28.0	66.0	36.0	6.00
R457N8	N8	5.06	0.1992	28.0	66.0	36.0	6.00
R4575.1	–	5.10	0.2008	28.0	66.0	36.0	6.00
R457N7	N7	5.11	0.2010	28.0	66.0	36.0	6.00
R45713/64	13/64	5.16	0.2031	28.0	66.0	36.0	6.00
R457N6	N6	5.18	0.2039	28.0	66.0	36.0	6.00
R4575.2	–	5.20	0.2047	28.0	66.0	36.0	6.00
R457N5	N5	5.22	0.2055	28.0	66.0	36.0	6.00
R4575.3	–	5.30	0.2087	28.0	66.0	36.0	6.00
R457N4	N4	5.31	0.2091	28.0	66.0	36.0	6.00
R4575.4	–	5.40	0.2126	28.0	66.0	36.0	6.00
R457N3	N3	5.41	0.2130	28.0	66.0	36.0	6.00
R4575.5	–	5.50	0.2165	28.0	66.0	36.0	6.00
R4577/32	7/32	5.56	0.2188	28.0	66.0	36.0	6.00
R4575.6	–	5.60	0.2205	28.0	66.0	36.0	6.00
R457N2	N2	5.61	0.2209	28.0	66.0	36.0	6.00
R4575.7	–	5.70	0.2244	28.0	66.0	36.0	6.00
R457N1	N1	5.79	0.2280	28.0	66.0	36.0	6.00
R4575.8	–	5.80	0.2283	28.0	66.0	36.0	6.00
R4575.9	–	5.90	0.2323	28.0	66.0	36.0	6.00
R457A	A	5.94	0.2339	28.0	66.0	36.0	6.00
R45715/64	15/64	5.95	0.2344	28.0	66.0	36.0	6.00
R4576.0	–	6.00	0.2362	28.0	66.0	36.0	6.00
R457B	B	6.05	0.2380	34.0	79.0	36.0	8.00
R4576.05	–	6.05	0.2382	34.0	79.0	36.0	8.00
R4576.1	–	6.10	0.2402	34.0	79.0	36.0	8.00
R457C	C	6.15	0.2421	34.0	79.0	36.0	8.00
R4576.2	–	6.20	0.2441	34.0	79.0	36.0	8.00
R457D	D	6.25	0.2461	34.0	79.0	36.0	8.00
R4576.3	–	6.30	0.2480	34.0	79.0	36.0	8.00
R4571/4	1/4	6.35	0.2500	34.0	79.0	36.0	8.00
R4576.4	–	6.40	0.2520	34.0	79.0	36.0	8.00
R4576.5	–	6.50	0.2559	34.0	79.0	36.0	8.00
R457F	F	6.53	0.2571	34.0	79.0	36.0	8.00
R4576.6	–	6.60	0.2598	34.0	79.0	36.0	8.00
R457G	G	6.63	0.2610	34.0	79.0	36.0	8.00
R4576.7	–	6.70	0.2638	34.0	79.0	36.0	8.00
R45717/64	17/64	6.75	0.2656	34.0	79.0	36.0	8.00
R4576.8	–	6.80	0.2677	34.0	79.0	36.0	8.00
R4576.9	–	6.90	0.2717	34.0	79.0	36.0	8.00
R457I	I	6.91	0.2720	34.0	79.0	36.0	8.00
R4577.0	–	7.00	0.2756	34.0	79.0	36.0	8.00



Product	DC	DC	DC	LCF	OAL	LS	DCON MS
	(inch)	(mm)	(inch)	(mm)	(mm)	(mm)	(mm)
R457J	J	7.04	0.2772	41.0	79.0	36.0	8.00
R4577.1	–	7.10	0.2795	41.0	79.0	36.0	8.00
R4579/32	9/32	7.14	0.2813	41.0	79.0	36.0	8.00
R4577.2	–	7.20	0.2835	41.0	79.0	36.0	8.00
R4577.3	–	7.30	0.2874	41.0	79.0	36.0	8.00
R4577.4	–	7.40	0.2913	41.0	79.0	36.0	8.00
R4577.5	–	7.50	0.2953	41.0	79.0	36.0	8.00
R45719/64	19/64	7.54	0.2969	41.0	79.0	36.0	8.00
R4577.6	–	7.60	0.2992	41.0	79.0	36.0	8.00
R457N	N	7.67	0.3020	41.0	79.0	36.0	8.00
R4577.7	–	7.70	0.3031	41.0	79.0	36.0	8.00
R4577.8	–	7.80	0.3071	41.0	79.0	36.0	8.00
R4577.9	–	7.90	0.3110	41.0	79.0	36.0	8.00
R4575/16	5/16	7.94	0.3125	41.0	79.0	36.0	8.00
R4578.0	–	8.00	0.3150	41.0	79.0	36.0	8.00
R4570	0	8.03	0.3161	47.0	89.0	40.0	10.00
R4578.05	–	8.05	0.3169	47.0	89.0	40.0	10.00
R4578.1	–	8.10	0.3189	47.0	89.0	40.0	10.00
R4578.2	–	8.20	0.3228	47.0	89.0	40.0	10.00
R457P	P	8.20	0.3228	47.0	89.0	40.0	10.00
R4578.3	–	8.30	0.3268	47.0	89.0	40.0	10.00
R45721/64	21/64	8.33	0.3281	47.0	89.0	40.0	10.00
R4578.4	–	8.40	0.3307	47.0	89.0	40.0	10.00
R457Q	Q	8.43	0.3319	47.0	89.0	40.0	10.00
R4578.5	–	8.50	0.3346	47.0	89.0	40.0	10.00
R4578.6	–	8.60	0.3386	47.0	89.0	40.0	10.00
R457R	R	8.61	0.3390	47.0	89.0	40.0	10.00
R4578.7	–	8.70	0.3425	47.0	89.0	40.0	10.00
R45711/32	11/32	8.73	0.3438	47.0	89.0	40.0	10.00
R4578.8	–	8.80	0.3465	47.0	89.0	40.0	10.00
R457S	S	8.84	0.3480	47.0	89.0	40.0	10.00
R4578.9	–	8.90	0.3504	47.0	89.0	40.0	10.00
R4579.0	–	9.00	0.3543	47.0	89.0	40.0	10.00
R4579.1	–	9.10	0.3583	47.0	89.0	40.0	10.00
R45723/64	23/64	9.13	0.3594	47.0	89.0	40.0	10.00
R4579.2	–	9.20	0.3622	47.0	89.0	40.0	10.00
R4579.3	–	9.30	0.3661	47.0	89.0	40.0	10.00
R457U	U	9.35	0.3681	47.0	89.0	40.0	10.00
R4579.4	–	9.40	0.3701	47.0	89.0	40.0	10.00
R4579.5	–	9.50	0.3740	47.0	89.0	40.0	10.00
R4573/8	3/8	9.53	0.3750	47.0	89.0	40.0	10.00
R457V	V	9.58	0.3772	47.0	89.0	40.0	10.00
R4579.6	–	9.60	0.3780	47.0	89.0	40.0	10.00
R4579.7	–	9.70	0.3819	47.0	89.0	40.0	10.00
R4579.8	–	9.80	0.3858	47.0	89.0	40.0	10.00
R457W	W	9.80	0.3858	47.0	89.0	40.0	10.00
R4579.9	–	9.90	0.3898	47.0	89.0	40.0	10.00
R45725/64	25/64	9.92	0.3906	47.0	89.0	40.0	10.00
R45710.0	–	10.00	0.3937	47.0	89.0	40.0	10.00
R45710.05	–	10.05	0.3957	55.0	102.0	45.0	12.00
R457X	X	10.08	0.3969	55.0	102.0	45.0	12.00
R45710.1	–	10.10	0.3976	55.0	102.0	45.0	12.00
R45710.2	–	10.20	0.4016	55.0	102.0	45.0	12.00
R457Y	Y	10.26	0.4039	55.0	102.0	45.0	12.00
R45710.3	–	10.30	0.4055	55.0	102.0	45.0	12.00
R45713/32	13/32	10.32	0.4063	55.0	102.0	45.0	12.00
R45710.4	–	10.40	0.4094	55.0	102.0	45.0	12.00
R457Z	Z	10.49	0.4130	55.0	102.0	45.0	12.00
R45710.5	–	10.50	0.4134	55.0	102.0	45.0	12.00
R45710.6	–	10.60	0.4173	55.0	102.0	45.0	12.00
R45727/64	27/64	10.72	0.4219	55.0	102.0	45.0	12.00
R45710.8	–	10.80	0.4252	55.0	102.0	45.0	12.00

Product	DC	DC	DC	LCF	OAL	LS	DCON MS
	(inch)	(mm)	(inch)	(mm)	(mm)	(mm)	(mm)
R45711.0	–	11.00	0.4331	55.0	102.0	45.0	12.00
R4577/16	7/16	11.11	0.4375	55.0	102.0	45.0	12.00
R45711.2	–	11.20	0.4409	55.0	102.0	45.0	12.00
R45711.3	–	11.30	0.4449	55.0	102.0	45.0	12.00
R45711.4	–	11.40	0.4488	55.0	102.0	45.0	12.00
R45711.5	–	11.50	0.4528	55.0	102.0	45.0	12.00
R45729/64	29/64	11.51	0.4531	55.0	102.0	45.0	12.00
R45711.6	–	11.60	0.4567	55.0	102.0	45.0	12.00
R45711.8	–	11.80	0.4646	55.0	102.0	45.0	12.00
R45715/32	15/32	11.91	0.4688	55.0	102.0	45.0	12.00
R45712.0	–	12.00	0.4724	55.0	102.0	45.0	12.00
R45712.05	–	12.05	0.4744	60.0	107.0	45.0	14.00
R45712.1	–	12.10	0.4764	60.0	107.0	45.0	14.00
R45712.2	–	12.20	0.4803	60.0	107.0	45.0	14.00
R45731/64	31/64	12.30	0.4844	60.0	107.0	45.0	14.00
R45712.5	–	12.50	0.4921	60.0	107.0	45.0	14.00
R45712.7	–	12.70	0.5000	60.0	107.0	45.0	14.00
R4571/2	1/2	12.70	0.5000	60.0	107.0	45.0	14.00
R45712.8	–	12.80	0.5039	60.0	107.0	45.0	14.00
R45713.0	–	13.00	0.5118	60.0	107.0	45.0	14.00
R45733/64	33/64	13.10	0.5156	60.0	107.0	45.0	14.00
R45713.3	–	13.30	0.5236	60.0	107.0	45.0	14.00
R45717/32	17/32	13.49	0.5313	60.0	107.0	45.0	14.00
R45713.5	–	13.50	0.5315	60.0	107.0	45.0	14.00
R45713.8	–	13.80	0.5433	60.0	107.0	45.0	14.00
R45735/64	35/64	13.89	0.5469	60.0	107.0	45.0	14.00
R45714.0	–	14.00	0.5512	60.0	107.0	45.0	14.00
R45714.25	–	14.25	0.5610	65.0	115.0	48.0	16.00
R4579/16	9/16	14.29	0.5625	65.0	115.0	48.0	16.00
R45714.5	–	14.50	0.5709	65.0	115.0	48.0	16.00
R45737/64	37/64	14.68	0.5781	65.0	115.0	48.0	16.00
R45714.8	–	14.80	0.5827	65.0	115.0	48.0	16.00
R45715.0	–	15.00	0.5906	65.0	115.0	48.0	16.00
R45719/32	19/32	15.08	0.5938	65.0	115.0	48.0	16.00
R45715.1	–	15.10	0.5945	65.0	115.0	48.0	16.00
R45715.3	–	15.30	0.6024	65.0	115.0	48.0	16.00
R45739/64	39/64	15.48	0.6094	65.0	115.0	48.0	16.00
R45715.5	–	15.50	0.6102	65.0	115.0	48.0	16.00
R45715.8	–	15.80	0.6220	65.0	115.0	48.0	16.00
R4575/8	5/8	15.88	0.6250	65.0	115.0	48.0	16.00
R45716.0	–	16.00	0.6299	65.0	115.0	48.0	16.00
R45741/64	41/64	16.27	0.6406	73.0	123.0	48.0	18.00
R45716.5	–	16.50	0.6496	73.0	123.0	48.0	18.00
R45721/32	21/32	16.67	0.6563	73.0	123.0	48.0	18.00
R45717.0	–	17.00	0.6693	73.0	123.0	48.0	18.00
R45743/64	43/64	17.07	0.6720	73.0	123.0	48.0	18.00
R45711/16	11/16	17.46	0.6874	73.0	123.0	48.0	18.00
R45717.5	–	17.50	0.6890	73.0	123.0	48.0	18.00
R45745/64	45/64	17.86	0.7031	73.0	123.0	48.0	18.00
R45718.0	–	18.00	0.7087	73.0	123.0	48.0	18.00
R45723/32	23/32	18.26	0.7189	79.0	131.0	50.0	20.00
R45718.5	–	18.50	0.7283	79.0	131.0	50.0	20.00
R45747/64	47/64	18.65	0.7343	79.0	131.0	50.0	20.00
R45718.8	–	18.80	0.7402	79.0	131.0	50.0	20.00
R45719.0	–	19.00	0.7480	79.0	131.0	50.0	20.00
R4573/4	3/4	19.05	0.7500	79.0	131.0	50.0	20.00
R45719.5	–	19.50	0.7677	79.0	131.0	50.0	20.00
R45719.8	–	19.80	0.7795	79.0	131.0	50.0	20.00
R45720.0	–	20.00	0.7874	79.0	131.0	50.0	20.00

R454



Broca FORCE X, Metal Duro 5XD, con Recubrimiento TiAlN

Broca de alto rendimiento, capaz de producir agujeros precisos y de alta calidad a altas velocidades y avances (tolerancia de agujero H9). Punta dividida de 4 facetas a 140° y alma continuamente adelgazada (CTW) para mejorar los índices de penetración. El recubrimiento TiAlN aumenta la dureza superficial y prolonga la vida de la herramienta.

FORCE X

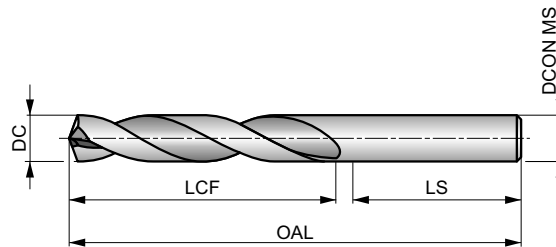

HM	DIN 6537L	5xD
140°	TiAlN	DIN 6535HA
CTW	R	DC m7

Grupo de Material de la pieza adecuado y condiciones de velocidad de corte iniciales (m/min) y código de avance alfabético. Tablas con avance por revolución a partir de la pag.274.

P1.1 ■ 134V	P1.2 ■ 150V	P1.3 ■ 155V	P2.1 ■ 115V	P2.2 ■ 101V	P2.3 ■ 89V	P3.1 ■ 100V	P3.2 ■ 80V	P3.3 ■ 68V	P4.1 ■ 59V	P4.2 ■ 50V	P4.3 ■ 41U	M1.1 ▣ 56U	M1.2 ▣ 48U
M2.1 ▣ 50U	M2.2 ▣ 41U	M2.3 ▣ 35T	M3.1 ▣ 31T	M3.2 ▣ 26T	M3.3 ▣ 24T	M4.1 ▣ 23T	M4.2 ▣ 20T	K1.1 ■ 83W	K1.2 ■ 61W	K1.3 ■ 46W	K2.1 ■ 74V	K2.2 ■ 60V	K2.3 ■ 48V
K3.1 ■ 65V	K3.2 ■ 50V	K3.3 ■ 41V	K4.1 ■ 61V	K4.2 ■ 46V	K4.3 ■ 34V	K4.4 ■ 29V	K4.5 ■ 24V	K5.1 ■ 68V	K5.2 ■ 52V	K5.3 ■ 40V	N1.1 ■ 188W	N1.2 ■ 141W	N1.3 ■ 94W
N2.1 ■ 231V	N2.2 ■ 208V	N2.3 ■ 150V	N3.1 ■ 280V	N3.2 ■ 165V	N3.3 ■ 83V	S1.1 ▣ 41U	S1.2 ▣ 34U	S1.3 ▣ 30T	H1.1 ■ 42U	H2.1 ▣ 25U	H2.2 ▣ 23U	H3.1 ▣ 28U	H3.2 ▣ 23U

DCON MS tolerancia h6.

Product	DC (inch)	DC (mm)	DC (inch)	LCF (mm)	OAL (mm)	LS (mm)	DCON MS (mm)
R4543.0	–	3.00	0.1181	28.0	66.0	36.0	6.00
R4543.1	–	3.10	0.1220	28.0	66.0	36.0	6.00
R4541/8	1/8	3.18	0.1250	28.0	66.0	36.0	6.00
R4543.2	–	3.20	0.1260	28.0	66.0	36.0	6.00
R454N30	N30	3.26	0.1283	28.0	66.0	36.0	6.00
R4543.3	–	3.30	0.1299	28.0	66.0	36.0	6.00
R4543.4	–	3.40	0.1339	28.0	66.0	36.0	6.00
R454N29	N29	3.45	0.1360	28.0	66.0	36.0	6.00
R4543.5	–	3.50	0.1378	28.0	66.0	36.0	6.00
R454N28	N28	3.57	0.1406	28.0	66.0	36.0	6.00
R4549/64	9/64	3.57	0.1406	28.0	66.0	36.0	6.00
R4543.6	–	3.60	0.1417	28.0	66.0	36.0	6.00
R454N27	N27	3.66	0.1441	28.0	66.0	36.0	6.00
R4543.7	–	3.70	0.1457	28.0	66.0	36.0	6.00
R454N26	N26	3.73	0.1469	36.0	74.0	36.0	6.00
R4543.8	–	3.80	0.1496	36.0	74.0	36.0	6.00
R454N24	N24	3.86	0.1520	36.0	74.0	36.0	6.00
R4543.9	–	3.90	0.1535	36.0	74.0	36.0	6.00
R4545/32	5/32	3.97	0.1563	36.0	74.0	36.0	6.00
R4544.0	–	4.00	0.1575	36.0	74.0	36.0	6.00
R454N21	N21	4.04	0.1591	36.0	74.0	36.0	6.00
R454N20	N20	4.09	0.1610	36.0	74.0	36.0	6.00
R4544.1	–	4.10	0.1614	36.0	74.0	36.0	6.00
R4544.2	–	4.20	0.1654	36.0	74.0	36.0	6.00
R454N19	N19	4.22	0.1661	36.0	74.0	36.0	6.00

Product	DC	DC	DC	LCF	OAL	LS	DCON MS
	(inch)	(mm)	(inch)	(mm)	(mm)	(mm)	(mm)
R4544.3	–	4.30	0.1693	36.0	74.0	36.0	6.00
R45411/64	11/64	4.37	0.1719	36.0	74.0	36.0	6.00
R4544.4	–	4.40	0.1732	36.0	74.0	36.0	6.00
R4544.5	–	4.50	0.1772	36.0	74.0	36.0	6.00
R454N16	N16	4.50	0.1772	36.0	74.0	36.0	6.00
R454N15	N15	4.57	0.1799	36.0	74.0	36.0	6.00
R4544.6	–	4.60	0.1811	36.0	74.0	36.0	6.00
R454N14	N14	4.62	0.1819	36.0	74.0	36.0	6.00
R4544.7	–	4.70	0.1850	36.0	74.0	36.0	6.00
R4543/16	3/16	4.76	0.1875	44.0	82.0	36.0	6.00
R4544.8	–	4.80	0.1890	44.0	82.0	36.0	6.00
R454N11	N11	4.85	0.1909	44.0	82.0	36.0	6.00
R4544.9	–	4.90	0.1929	44.0	82.0	36.0	6.00
R454N10	N10	4.92	0.1937	44.0	82.0	36.0	6.00
R454N9	N9	4.98	0.1961	44.0	82.0	36.0	6.00
R4545.0	–	5.00	0.1969	44.0	82.0	36.0	6.00
R454N8	N8	5.06	0.1992	44.0	82.0	36.0	6.00
R4545.1	–	5.10	0.2008	44.0	82.0	36.0	6.00
R454N7	N7	5.11	0.2010	44.0	82.0	36.0	6.00
R45413/64	13/64	5.16	0.2031	44.0	82.0	36.0	6.00
R454N6	N6	5.18	0.2039	44.0	82.0	36.0	6.00
R4545.2	–	5.20	0.2047	44.0	82.0	36.0	6.00
R454N5	N5	5.22	0.2055	44.0	82.0	36.0	6.00
R454N4	N4	5.31	0.2091	44.0	82.0	36.0	6.00
R454N3	N3	5.41	0.2130	44.0	82.0	36.0	6.00
R4545.5	–	5.50	0.2165	44.0	82.0	36.0	6.00
R4547/32	7/32	5.56	0.2188	44.0	82.0	36.0	6.00
R4545.6	–	5.60	0.2205	44.0	82.0	36.0	6.00
R454N2	N2	5.61	0.2209	44.0	82.0	36.0	6.00
R4545.7	–	5.70	0.2244	44.0	82.0	36.0	6.00
R454N1	N1	5.79	0.2280	44.0	82.0	36.0	6.00
R4545.8	–	5.80	0.2283	44.0	82.0	36.0	6.00
R454A	A	5.94	0.2339	44.0	82.0	36.0	6.00
R45415/64	15/64	5.95	0.2344	44.0	82.0	36.0	6.00
R4546.0	–	6.00	0.2362	44.0	82.0	36.0	6.00
R454B	B	6.05	0.2380	53.0	91.0	36.0	8.00
R4546.1	–	6.10	0.2402	53.0	91.0	36.0	8.00
R454C	C	6.15	0.2421	53.0	91.0	36.0	8.00
R4546.2	–	6.20	0.2441	53.0	91.0	36.0	8.00
R454D	D	6.25	0.2461	53.0	91.0	36.0	8.00
R4546.3	–	6.30	0.2480	53.0	91.0	36.0	8.00
R4541/4	1/4	6.35	0.2500	53.0	91.0	36.0	8.00
R454E	E	6.35	0.2500	53.0	91.0	36.0	8.00
R4546.4	–	6.40	0.2520	53.0	91.0	36.0	8.00
R4546.5	–	6.50	0.2559	53.0	91.0	36.0	8.00
R454F	F	6.53	0.2571	53.0	91.0	36.0	8.00
R4546.6	–	6.60	0.2598	53.0	91.0	36.0	8.00
R454G	G	6.63	0.2610	53.0	91.0	36.0	8.00
R4546.7	–	6.70	0.2638	53.0	91.0	36.0	8.00
R45417/64	17/64	6.75	0.2656	53.0	91.0	36.0	8.00
R454H	H	6.76	0.2661	53.0	91.0	36.0	8.00
R4546.8	–	6.80	0.2677	53.0	91.0	36.0	8.00
R4546.9	–	6.90	0.2717	53.0	91.0	36.0	8.00
R454I	I	6.91	0.2720	53.0	91.0	36.0	8.00
R4547.0	–	7.00	0.2756	53.0	91.0	36.0	8.00
R454J	J	7.04	0.2772	53.0	91.0	36.0	8.00
R4547.1	–	7.10	0.2795	53.0	91.0	36.0	8.00
R4549/32	9/32	7.14	0.2813	53.0	91.0	36.0	8.00
R4547.3	–	7.30	0.2874	53.0	91.0	36.0	8.00
R454L	L	7.37	0.2902	53.0	91.0	36.0	8.00
R4547.4	–	7.40	0.2913	53.0	91.0	36.0	8.00
R4547.5	–	7.50	0.2953	53.0	91.0	36.0	8.00



Product	DC	DC	DC	LCF	OAL	LS	DCON MS
	(inch)	(mm)	(inch)	(mm)	(mm)	(mm)	(mm)
R45419/64	19/64	7.54	0.2969	53.0	91.0	36.0	8.00
R4547.6	–	7.60	0.2992	53.0	91.0	36.0	8.00
R454N	N	7.67	0.3020	53.0	91.0	36.0	8.00
R4547.7	–	7.70	0.3031	53.0	91.0	36.0	8.00
R4547.8	–	7.80	0.3071	53.0	91.0	36.0	8.00
R4547.9	–	7.90	0.3110	53.0	91.0	36.0	8.00
R4545/16	5/16	7.94	0.3125	53.0	91.0	36.0	8.00
R4548.0	–	8.00	0.3150	53.0	91.0	36.0	8.00
R4540	0	8.03	0.3161	61.0	103.0	40.0	10.00
R4548.1	–	8.10	0.3189	61.0	103.0	40.0	10.00
R4548.2	–	8.20	0.3228	61.0	103.0	40.0	10.00
R45421/64	21/64	8.33	0.3281	61.0	103.0	40.0	10.00
R4548.4	–	8.40	0.3307	61.0	103.0	40.0	10.00
R454Q	Q	8.43	0.3319	61.0	103.0	40.0	10.00
R4548.5	–	8.50	0.3346	61.0	103.0	40.0	10.00
R4548.6	–	8.60	0.3386	61.0	103.0	40.0	10.00
R454R	R	8.61	0.3390	61.0	103.0	40.0	10.00
R4548.7	–	8.70	0.3425	61.0	103.0	40.0	10.00
R45411/32	11/32	8.73	0.3438	61.0	103.0	40.0	10.00
R4548.8	–	8.80	0.3465	61.0	103.0	40.0	10.00
R454S	S	8.84	0.3480	61.0	103.0	40.0	10.00
R4548.9	–	8.90	0.3504	61.0	103.0	40.0	10.00
R4549.0	–	9.00	0.3543	61.0	103.0	40.0	10.00
R4549.1	–	9.10	0.3583	61.0	103.0	40.0	10.00
R45423/64	23/64	9.13	0.3594	61.0	103.0	40.0	10.00
R4549.3	–	9.30	0.3661	61.0	103.0	40.0	10.00
R454U	U	9.35	0.3681	61.0	103.0	40.0	10.00
R4549.4	–	9.40	0.3701	61.0	103.0	40.0	10.00
R4549.5	–	9.50	0.3740	61.0	103.0	40.0	10.00
R4543/8	3/8	9.53	0.3750	61.0	103.0	40.0	10.00
R4549.6	–	9.60	0.3780	61.0	103.0	40.0	10.00
R4549.7	–	9.70	0.3819	61.0	103.0	40.0	10.00
R4549.8	–	9.80	0.3858	61.0	103.0	40.0	10.00
R4549.9	–	9.90	0.3898	61.0	103.0	40.0	10.00
R454W	W	9.80	0.3858	61.0	103.0	40.0	10.00
R45425/64	25/64	9.92	0.3906	61.0	103.0	40.0	10.00
R45410.0	–	10.00	0.3937	61.0	103.0	40.0	10.00
R454X	X	10.08	0.3969	70.0	118.0	45.0	12.00
R45410.1	–	10.10	0.3976	70.0	118.0	45.0	12.00
R45410.2	–	10.20	0.4016	70.0	118.0	45.0	12.00
R454Y	Y	10.26	0.4039	70.0	118.0	45.0	12.00
R45410.3	–	10.30	0.4055	70.0	118.0	45.0	12.00
R45413/32	13/32	10.32	0.4063	70.0	118.0	45.0	12.00
R45410.4	–	10.40	0.4094	70.0	118.0	45.0	12.00
R454Z	Z	10.49	0.4130	70.0	118.0	45.0	12.00
R45410.5	–	10.50	0.4134	70.0	118.0	45.0	12.00
R45410.6	–	10.60	0.4173	70.0	118.0	45.0	12.00
R45427/64	27/64	10.72	0.4219	70.0	118.0	45.0	12.00
R45411.0	–	11.00	0.4331	70.0	118.0	45.0	12.00
R4547/16	7/16	11.11	0.4375	70.0	118.0	45.0	12.00
R45411.2	–	11.20	0.4409	70.0	118.0	45.0	12.00
R45411.4	–	11.40	0.4488	70.0	118.0	45.0	12.00
R45411.5	–	11.50	0.4528	70.0	118.0	45.0	12.00
R45429/64	29/64	11.51	0.4531	70.0	118.0	45.0	12.00
R45411.6	–	11.60	0.4567	70.0	118.0	45.0	12.00
R45411.8	–	11.80	0.4646	70.0	118.0	45.0	12.00
R45415/32	15/32	11.91	0.4688	70.0	118.0	45.0	12.00
R45412.0	–	12.00	0.4724	70.0	118.0	45.0	12.00
R45412.1	–	12.10	0.4764	76.0	124.0	45.0	14.00
R45412.2	–	12.20	0.4803	76.0	124.0	45.0	14.00
R45431/64	31/64	12.30	0.4844	76.0	124.0	45.0	14.00
R45412.5	–	12.50	0.4921	76.0	124.0	45.0	14.00

Product	DC	DC	DC	LCF	OAL	LS	DCON MS
	(inch)	(mm)	(inch)	(mm)	(mm)	(mm)	(mm)
R45412.7	–	12.70	0.5000	76.0	124.0	45.0	14.00
R4541/2	1/2	12.70	0.5000	76.0	124.0	45.0	14.00
R45412.8	–	12.80	0.5039	76.0	124.0	45.0	14.00
R45413.0	–	13.00	0.5118	76.0	124.0	45.0	14.00
R45433/64	33/64	13.10	0.5156	76.0	124.0	45.0	14.00
R45417/32	17/32	13.49	0.5313	76.0	124.0	45.0	14.00
R45413.5	–	13.50	0.5315	76.0	124.0	45.0	14.00
R45413.8	–	13.80	0.5433	76.0	124.0	45.0	14.00
R45435/64	35/64	13.89	0.5469	76.0	124.0	45.0	14.00
R45414.0	–	14.00	0.5512	76.0	124.0	45.0	14.00
R45414.25	–	14.25	0.5610	82.0	133.0	48.0	16.00
R4549/16	9/16	14.29	0.5625	82.0	133.0	48.0	16.00
R45414.5	–	14.50	0.5709	82.0	133.0	48.0	16.00
R45437/64	37/64	14.68	0.5781	82.0	133.0	48.0	16.00
R45414.8	–	14.80	0.5827	82.0	133.0	48.0	16.00
R45415.0	–	15.00	0.5906	82.0	133.0	48.0	16.00
R45419/32	19/32	15.08	0.5938	82.0	133.0	48.0	16.00
R45415.1	–	15.10	0.5945	82.0	133.0	48.0	16.00
R45439/64	39/64	15.48	0.6094	82.0	133.0	48.0	16.00
R45415.5	–	15.50	0.6102	82.0	133.0	48.0	16.00
R45415.8	–	15.80	0.6220	82.0	133.0	48.0	16.00
R4545/8	5/8	15.88	0.6250	82.0	133.0	48.0	16.00
R45416.0	–	16.00	0.6299	82.0	133.0	48.0	16.00
R45441/64	41/64	16.27	0.6406	91.0	143.0	48.0	18.00
R45416.5	–	16.50	0.6496	91.0	143.0	48.0	18.00
R45421/32	21/32	16.67	0.6563	91.0	143.0	48.0	18.00
R45417.0	–	17.00	0.6693	91.0	143.0	48.0	18.00
R45443/64	43/64	17.07	0.6720	91.0	143.0	48.0	18.00
R45411/16	11/16	17.46	0.6874	91.0	143.0	48.0	18.00
R45417.5	–	17.50	0.6890	91.0	143.0	48.0	18.00
R45417.8	–	17.80	0.7008	91.0	143.0	48.0	18.00
R45445/64	45/64	17.86	0.7031	91.0	143.0	48.0	18.00
R45418.0	–	18.00	0.7087	91.0	143.0	48.0	18.00
R45423/32	23/32	18.26	0.7189	99.0	153.0	50.0	20.00
R45418.5	–	18.50	0.7283	99.0	153.0	50.0	20.00
R45447/64	47/64	18.65	0.7343	99.0	153.0	50.0	20.00
R45419.0	–	19.00	0.7480	99.0	153.0	50.0	20.00
R4543/4	3/4	19.05	0.7500	99.0	153.0	50.0	20.00
R45419.5	–	19.50	0.7677	99.0	153.0	50.0	20.00
R45419.8	–	19.80	0.7795	99.0	153.0	50.0	20.00
R45420.0	–	20.00	0.7874	99.0	153.0	50.0	20.00

R453



Broca FORCE X, Metal Duro 5XD, con Refrigeración Interna, con Recubrimiento TiAlN

Broca de alto rendimiento, capaz de producir agujeros precisos y de alta calidad a altas velocidades y avances (tolerancia de agujero H9). Punta dividida de 4 facetas a 140 ° y alma continuamente adelgazada (CTW) para mejorar los índices de penetración. Los agujeros de refrigeración permiten mejorar la evacuación de virutas. El recubrimiento TiAlN aumenta la dureza superficial y prolonga la vida de la herramienta.

FORCE X

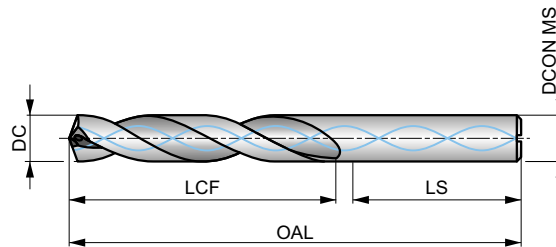

HM	DIN 6537L	5xD
140°	TiAlN	DIN 6535HA
CTW	R	Water Spray
DC m7		

Grupo de Material de la pieza adecuado y condiciones de velocidad de corte iniciales (m/min) y código de avance alfabético. Tablas con avance por revolución a partir de la pag.274.

P1.1 ■ 170V	P1.2 ■ 190V	P1.3 ■ 197V	P2.1 ■ 145V	P2.2 ■ 128V	P2.3 ■ 113V	P3.1 ■ 126V	P3.2 ■ 102V	P3.3 ■ 86V	P4.1 ■ 75V	P4.2 ■ 64V	P4.3 ■ 52U	M1.1 ▣ 71V	M1.2 ▣ 61V
M2.1 ▣ 64V	M2.2 ▣ 52V	M2.3 ▣ 44U	M3.1 ▣ 39V	M3.2 ▣ 33V	M3.3 ▣ 30V	M4.1 ▣ 29U	M4.2 ▣ 25U	K1.1 ■ 105W	K1.2 ■ 77W	K1.3 ■ 58W	K2.1 ■ 93V	K2.2 ■ 76V	K2.3 ■ 61V
K3.1 ■ 83V	K3.2 ■ 64V	K3.3 ■ 51V	K4.1 ■ 77V	K4.2 ■ 58V	K4.3 ■ 43V	K4.4 ■ 36V	K4.5 ■ 30V	K5.1 ■ 86V	K5.2 ■ 66V	K5.3 ■ 50V	N1.1 ■ 238W	N1.2 ■ 179W	N1.3 ■ 119W
N2.1 ■ 293V	N2.2 ■ 263V	N2.3 ■ 190V	N3.1 ■ 354W	N3.2 ■ 209W	N3.3 ■ 105W	S1.1 ■ 52V	S1.2 ■ 43V	S1.3 ■ 38U	H1.1 ■ 53U	H2.1 ▣ 31U	H2.2 ▣ 29U	H3.1 ▣ 35U	H3.2 ▣ 29U

DCON MS tolerancia h6.

Product	DC (inch)	DC (mm)	DC (inch)	LCF (mm)	OAL (mm)	LS (mm)	DCON MS (mm)
R4533.0	-	3.00	0.1181	28.0	66.0	36.0	6.00
R4533.1	-	3.10	0.1220	28.0	66.0	36.0	6.00
R4531/8	1/8	3.18	0.1250	28.0	66.0	36.0	6.00
R4533.2	-	3.20	0.1260	28.0	66.0	36.0	6.00
R453N30	N30	3.26	0.1283	28.0	66.0	36.0	6.00
R4533.3	-	3.30	0.1299	28.0	66.0	36.0	6.00
R4533.4	-	3.40	0.1339	28.0	66.0	36.0	6.00
R453N29	N29	3.45	0.1360	28.0	66.0	36.0	6.00
R4533.5	-	3.50	0.1378	28.0	66.0	36.0	6.00
R453N28	N28	3.57	0.1406	28.0	66.0	36.0	6.00
R4539/64	9/64	3.57	0.1406	28.0	66.0	36.0	6.00
R4533.6	-	3.60	0.1417	28.0	66.0	36.0	6.00
R453N27	N27	3.66	0.1441	28.0	66.0	36.0	6.00
R4533.7	-	3.70	0.1457	28.0	66.0	36.0	6.00
R453N26	N26	3.73	0.1469	36.0	74.0	36.0	6.00
R4533.8	-	3.80	0.1496	36.0	74.0	36.0	6.00
R453N24	N24	3.86	0.1520	36.0	74.0	36.0	6.00
R4533.9	-	3.90	0.1535	36.0	74.0	36.0	6.00
R453N23	N23	3.91	0.1539	36.0	74.0	36.0	6.00
R4535/32	5/32	3.97	0.1563	36.0	74.0	36.0	6.00
R453N22	N22	3.99	0.1571	36.0	74.0	36.0	6.00
R4534.0	-	4.00	0.1575	36.0	74.0	36.0	6.00
R453N21	N21	4.04	0.1591	36.0	74.0	36.0	6.00
R4534.05	-	4.05	0.1594	36.0	74.0	36.0	6.00
R453N20	N20	4.09	0.1610	36.0	74.0	36.0	6.00

Product	DC	DC	DC	LCF	OAL	LS	DCON MS
	(inch)	(mm)	(inch)	(mm)	(mm)	(mm)	(mm)
R4534.1	–	4.10	0.1614	36.0	74.0	36.0	6.00
R4534.2	–	4.20	0.1654	36.0	74.0	36.0	6.00
R453N19	N19	4.22	0.1661	36.0	74.0	36.0	6.00
R4534.3	–	4.30	0.1693	36.0	74.0	36.0	6.00
R453N18	N18	4.31	0.1697	36.0	74.0	36.0	6.00
R45311/64	11/64	4.37	0.1719	36.0	74.0	36.0	6.00
R4534.4	–	4.40	0.1732	36.0	74.0	36.0	6.00
R4534.5	–	4.50	0.1772	36.0	74.0	36.0	6.00
R453N16	N16	4.50	0.1772	36.0	74.0	36.0	6.00
R453N15	N15	4.57	0.1799	36.0	74.0	36.0	6.00
R4534.6	–	4.60	0.1811	36.0	74.0	36.0	6.00
R453N14	N14	4.62	0.1819	36.0	74.0	36.0	6.00
R4534.7	–	4.70	0.1850	36.0	74.0	36.0	6.00
R4533/16	3/16	4.76	0.1875	44.0	82.0	36.0	6.00
R4534.8	–	4.80	0.1890	44.0	82.0	36.0	6.00
R453N12	N12	4.80	0.1890	44.0	82.0	36.0	6.00
R453N11	N11	4.85	0.1909	44.0	82.0	36.0	6.00
R4534.9	–	4.90	0.1929	44.0	82.0	36.0	6.00
R453N10	N10	4.92	0.1937	44.0	82.0	36.0	6.00
R453N9	N9	4.98	0.1961	44.0	82.0	36.0	6.00
R4535.0	–	5.00	0.1969	44.0	82.0	36.0	6.00
R4535.05	–	5.05	0.1988	44.0	82.0	36.0	6.00
R453N8	N8	5.06	0.1992	44.0	82.0	36.0	6.00
R4535.1	–	5.10	0.2008	44.0	82.0	36.0	6.00
R453N7	N7	5.11	0.2010	44.0	82.0	36.0	6.00
R45313/64	13/64	5.16	0.2031	44.0	82.0	36.0	6.00
R4535.2	–	5.20	0.2047	44.0	82.0	36.0	6.00
R453N5	N5	5.22	0.2055	44.0	82.0	36.0	6.00
R4535.3	–	5.30	0.2087	44.0	82.0	36.0	6.00
R453N4	N4	5.31	0.2091	44.0	82.0	36.0	6.00
R4535.4	–	5.40	0.2126	44.0	82.0	36.0	6.00
R453N3	N3	5.41	0.2130	44.0	82.0	36.0	6.00
R4535.5	–	5.50	0.2165	44.0	82.0	36.0	6.00
R4537/32	7/32	5.56	0.2188	44.0	82.0	36.0	6.00
R4535.6	–	5.60	0.2205	44.0	82.0	36.0	6.00
R453N2	N2	5.61	0.2209	44.0	82.0	36.0	6.00
R4535.7	–	5.70	0.2244	44.0	82.0	36.0	6.00
R453N1	N1	5.79	0.2280	44.0	82.0	36.0	6.00
R4535.8	–	5.80	0.2283	44.0	82.0	36.0	6.00
R4535.9	–	5.90	0.2323	44.0	82.0	36.0	6.00
R453A	A	5.94	0.2339	44.0	82.0	36.0	6.00
R45315/64	15/64	5.95	0.2344	44.0	82.0	36.0	6.00
R4536.0	–	6.00	0.2362	44.0	82.0	36.0	6.00
R453B	B	6.05	0.2380	53.0	91.0	36.0	8.00
R4536.05	–	6.05	0.2382	53.0	91.0	36.0	8.00
R4536.1	–	6.10	0.2402	53.0	91.0	36.0	8.00
R453C	C	6.15	0.2421	53.0	91.0	36.0	8.00
R4536.2	–	6.20	0.2441	53.0	91.0	36.0	8.00
R453D	D	6.25	0.2461	53.0	91.0	36.0	8.00
R4536.3	–	6.30	0.2480	53.0	91.0	36.0	8.00
R4531/4	1/4	6.35	0.2500	53.0	91.0	36.0	8.00
R4536.4	–	6.40	0.2520	53.0	91.0	36.0	8.00
R4536.5	–	6.50	0.2559	53.0	91.0	36.0	8.00
R453F	F	6.53	0.2571	53.0	91.0	36.0	8.00
R4536.6	–	6.60	0.2598	53.0	91.0	36.0	8.00
R453G	G	6.63	0.2610	53.0	91.0	36.0	8.00
R4536.7	–	6.70	0.2638	53.0	91.0	36.0	8.00
R45317/64	17/64	6.75	0.2656	53.0	91.0	36.0	8.00
R4536.8	–	6.80	0.2677	53.0	91.0	36.0	8.00
R4536.9	–	6.90	0.2717	53.0	91.0	36.0	8.00
R453I	I	6.91	0.2720	53.0	91.0	36.0	8.00
R4537.0	–	7.00	0.2756	53.0	91.0	36.0	8.00



Product	DC	DC	DC	LCF	OAL	LS	DCON MS
	(inch)	(mm)	(inch)	(mm)	(mm)	(mm)	(mm)
R453J	J	7.04	0.2772	53.0	91.0	36.0	8.00
R4537.1	–	7.10	0.2795	53.0	91.0	36.0	8.00
R453K	K	7.14	0.2811	53.0	91.0	36.0	8.00
R4539/32	9/32	7.14	0.2813	53.0	91.0	36.0	8.00
R4537.2	–	7.20	0.2835	53.0	91.0	36.0	8.00
R4537.3	–	7.30	0.2874	53.0	91.0	36.0	8.00
R453L	L	7.37	0.2902	53.0	91.0	36.0	8.00
R4537.4	–	7.40	0.2913	53.0	91.0	36.0	8.00
R453M	M	7.49	0.2949	53.0	91.0	36.0	8.00
R4537.5	–	7.50	0.2953	53.0	91.0	36.0	8.00
R45319/64	19/64	7.54	0.2969	53.0	91.0	36.0	8.00
R4537.6	–	7.60	0.2992	53.0	91.0	36.0	8.00
R453N	N	7.67	0.3020	53.0	91.0	36.0	8.00
R4537.7	–	7.70	0.3031	53.0	91.0	36.0	8.00
R4537.8	–	7.80	0.3071	53.0	91.0	36.0	8.00
R4537.9	–	7.90	0.3110	53.0	91.0	36.0	8.00
R4535/16	5/16	7.94	0.3125	53.0	91.0	36.0	8.00
R4538.0	–	8.00	0.3150	53.0	91.0	36.0	8.00
R453O	O	8.03	0.3161	61.0	103.0	40.0	10.00
R4538.05	–	8.05	0.3169	61.0	103.0	40.0	10.00
R4538.1	–	8.10	0.3189	61.0	103.0	40.0	10.00
R4538.2	–	8.20	0.3228	61.0	103.0	40.0	10.00
R453P	P	8.20	0.3228	61.0	103.0	40.0	10.00
R4538.3	–	8.30	0.3268	61.0	103.0	40.0	10.00
R45321/64	21/64	8.33	0.3281	61.0	103.0	40.0	10.00
R4538.4	–	8.40	0.3307	61.0	103.0	40.0	10.00
R453Q	Q	8.43	0.3319	61.0	103.0	40.0	10.00
R4538.5	–	8.50	0.3346	61.0	103.0	40.0	10.00
R4538.6	–	8.60	0.3386	61.0	103.0	40.0	10.00
R453R	R	8.61	0.3390	61.0	103.0	40.0	10.00
R4538.7	–	8.70	0.3425	61.0	103.0	40.0	10.00
R45311/32	11/32	8.73	0.3438	61.0	103.0	40.0	10.00
R4538.8	–	8.80	0.3465	61.0	103.0	40.0	10.00
R453S	S	8.84	0.3480	61.0	103.0	40.0	10.00
R4538.9	–	8.90	0.3504	61.0	103.0	40.0	10.00
R4539.0	–	9.00	0.3543	61.0	103.0	40.0	10.00
R4539.1	–	9.10	0.3583	61.0	103.0	40.0	10.00
R45323/64	23/64	9.13	0.3594	61.0	103.0	40.0	10.00
R4539.2	–	9.20	0.3622	61.0	103.0	40.0	10.00
R4539.3	–	9.30	0.3661	61.0	103.0	40.0	10.00
R453U	U	9.35	0.3681	61.0	103.0	40.0	10.00
R4539.4	–	9.40	0.3701	61.0	103.0	40.0	10.00
R4539.5	–	9.50	0.3740	61.0	103.0	40.0	10.00
R4533/8	3/8	9.53	0.3750	61.0	103.0	40.0	10.00
R4539.6	–	9.60	0.3780	61.0	103.0	40.0	10.00
R4539.7	–	9.70	0.3819	61.0	103.0	40.0	10.00
R4539.8	–	9.80	0.3858	61.0	103.0	40.0	10.00
R453W	W	9.80	0.3858	61.0	103.0	40.0	10.00
R4539.9	–	9.90	0.3898	61.0	103.0	40.0	10.00
R45325/64	25/64	9.92	0.3906	61.0	103.0	40.0	10.00
R45310.0	–	10.00	0.3937	61.0	103.0	40.0	10.00
R45310.05	–	10.05	0.3957	70.0	118.0	45.0	12.00
R453X	X	10.08	0.3969	70.0	118.0	45.0	12.00
R45310.1	–	10.10	0.3976	70.0	118.0	45.0	12.00
R45310.2	–	10.20	0.4016	70.0	118.0	45.0	12.00
R453Y	Y	10.26	0.4039	70.0	118.0	45.0	12.00
R45310.3	–	10.30	0.4055	70.0	118.0	45.0	12.00
R45313/32	13/32	10.32	0.4063	70.0	118.0	45.0	12.00
R45310.4	–	10.40	0.4094	70.0	118.0	45.0	12.00
R45310.5	–	10.50	0.4134	70.0	118.0	45.0	12.00
R45310.6	–	10.60	0.4173	70.0	118.0	45.0	12.00
R45327/64	27/64	10.72	0.4219	70.0	118.0	45.0	12.00

Product	DC	DC	DC	LCF	OAL	LS	DCON MS
	(inch)	(mm)	(inch)	(mm)	(mm)	(mm)	(mm)
R45310.8	–	10.80	0.4252	70.0	118.0	45.0	12.00
R45311.0	–	11.00	0.4331	70.0	118.0	45.0	12.00
R4537/16	7/16	11.11	0.4375	70.0	118.0	45.0	12.00
R45311.2	–	11.20	0.4409	70.0	118.0	45.0	12.00
R45311.3	–	11.30	0.4449	70.0	118.0	45.0	12.00
R45311.4	–	11.40	0.4488	70.0	118.0	45.0	12.00
R45311.5	–	11.50	0.4528	70.0	118.0	45.0	12.00
R45329/64	29/64	11.51	0.4531	70.0	118.0	45.0	12.00
R45311.6	–	11.60	0.4567	70.0	118.0	45.0	12.00
R45311.8	–	11.80	0.4646	70.0	118.0	45.0	12.00
R45315/32	15/32	11.91	0.4688	70.0	118.0	45.0	12.00
R45312.0	–	12.00	0.4724	70.0	118.0	45.0	12.00
R45312.05	–	12.05	0.4744	76.0	124.0	45.0	14.00
R45312.2	–	12.20	0.4803	76.0	124.0	45.0	14.00
R45331/64	31/64	12.30	0.4844	76.0	124.0	45.0	14.00
R45312.5	–	12.50	0.4921	76.0	124.0	45.0	14.00
R45312.7	–	12.70	0.5000	76.0	124.0	45.0	14.00
R4531/2	1/2	12.70	0.5000	76.0	124.0	45.0	14.00
R45312.8	–	12.80	0.5039	76.0	124.0	45.0	14.00
R45313.0	–	13.00	0.5118	76.0	124.0	45.0	14.00
R45333/64	33/64	13.10	0.5156	76.0	124.0	45.0	14.00
R45313.3	–	13.30	0.5236	76.0	124.0	45.0	14.00
R45317/32	17/32	13.49	0.5313	76.0	124.0	45.0	14.00
R45313.5	–	13.50	0.5315	76.0	124.0	45.0	14.00
R45313.8	–	13.80	0.5433	76.0	124.0	45.0	14.00
R45335/64	35/64	13.89	0.5469	76.0	124.0	45.0	14.00
R45314.0	–	14.00	0.5512	76.0	124.0	45.0	14.00
R45314.25	–	14.25	0.5610	82.0	133.0	48.0	16.00
R4539/16	9/16	14.29	0.5625	82.0	133.0	48.0	16.00
R45314.5	–	14.50	0.5709	82.0	133.0	48.0	16.00
R45337/64	37/64	14.68	0.5781	82.0	133.0	48.0	16.00
R45314.8	–	14.80	0.5827	82.0	133.0	48.0	16.00
R45315.0	–	15.00	0.5906	82.0	133.0	48.0	16.00
R45319/32	19/32	15.08	0.5938	82.0	133.0	48.0	16.00
R45315.1	–	15.10	0.5945	82.0	133.0	48.0	16.00
R45315.3	–	15.30	0.6024	82.0	133.0	48.0	16.00
R45315.5	–	15.50	0.6102	82.0	133.0	48.0	16.00
R45315.8	–	15.80	0.6220	82.0	133.0	48.0	16.00
R4535/8	5/8	15.88	0.6250	82.0	133.0	48.0	16.00
R45316.0	–	16.00	0.6299	82.0	133.0	48.0	16.00
R45341/64	41/64	16.27	0.6406	91.0	143.0	48.0	18.00
R45316.5	–	16.50	0.6496	91.0	143.0	48.0	18.00
R45321/32	21/32	16.67	0.6563	91.0	143.0	48.0	18.00
R45317.0	–	17.00	0.6693	91.0	143.0	48.0	18.00
R45343/64	43/64	17.07	0.6720	91.0	143.0	48.0	18.00
R45311/16	11/16	17.46	0.6874	91.0	143.0	48.0	18.00
R45317.5	–	17.50	0.6890	91.0	143.0	48.0	18.00
R45317.8	–	17.80	0.7008	91.0	143.0	48.0	18.00
R45345/64	45/64	17.86	0.7031	91.0	143.0	48.0	18.00
R45318.0	–	18.00	0.7087	91.0	143.0	48.0	18.00
R45323/32	23/32	18.26	0.7189	99.0	153.0	50.0	20.00
R45318.5	–	18.50	0.7283	99.0	153.0	50.0	20.00
R45347/64	47/64	18.65	0.7343	99.0	153.0	50.0	20.00
R45319.0	–	19.00	0.7480	99.0	153.0	50.0	20.00
R4533/4	3/4	19.05	0.7500	99.0	153.0	50.0	20.00
R45319.5	–	19.50	0.7677	99.0	153.0	50.0	20.00
R45319.8	–	19.80	0.7795	99.0	153.0	50.0	20.00
R45320.0	–	20.00	0.7874	99.0	153.0	50.0	20.00

R459



Broca FORCE X, Metal Duro 8XD, con Refrigeración Interna, con Recubrimiento TiAlN

Broca de alto rendimiento, capaz de producir agujeros precisos y de alta calidad a altas velocidades y avances (tolerancia de agujero H9). Punta dividida de 4 facetas a 140 ° y alma continuamente adelgazada (CTW) para mejorar los índices de penetración. Los agujeros de refrigeración permiten mejorar la evacuación de virutas. El recubrimiento TiAlN aumenta la dureza superficial y prolonga la vida de la herramienta.

FORCE X

HM	DORMER	8xD
140°	TiAlN	DIN 6535HA
CTW	R	
DC m7		

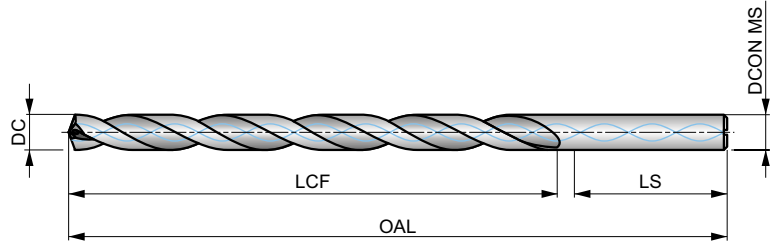

Grupo de Material de la pieza adecuado y condiciones de velocidad de corte iniciales (m/min) y código de avance alfabético. Tablas con avance por revolución a partir de la pag.274.

P1.1 ■ 143 V	P1.2 ■ 160 V	P1.3 ■ 166 V	P2.1 ■ 122 V	P2.2 ■ 108 U	P2.3 ■ 95 U	P3.1 ■ 106 U	P3.2 ■ 86 U	P3.3 ■ 72 U	P4.1 ■ 63 U	P4.2 ■ 54 U	P4.3 ■ 44 T	M1.1 ▣ 60 V	M1.2 ▣ 51 V
M2.1 ▣ 54 V	M2.2 ▣ 44 V	M2.3 ▣ 37 U	M3.1 ▣ 33 V	M3.2 ▣ 28 V	M3.3 ▣ 26 V	M4.1 ▣ 24 U	M4.2 ▣ 21 U	K1.1 ■ 88 W	K1.2 ■ 65 W	K1.3 ■ 49 W	K2.1 ■ 78 V	K2.2 ■ 64 V	K2.3 ■ 51 V
K3.1 ■ 70 V	K3.2 ■ 54 V	K3.3 ■ 43 V	K4.1 ■ 65 V	K4.2 ■ 49 V	K4.3 ■ 36 V	K4.4 ■ 30 V	K4.5 ■ 26 V	K5.1 ■ 73 V	K5.2 ■ 55 V	K5.3 ■ 42 V	N1.1 ▣ 1200 W	N1.2 ▣ 150 W	N1.3 ■ 100 W
N2.1 ■ 246 V	N2.2 ■ 222 V	N2.3 ■ 160 V	N3.1 ▣ 298 V	N3.2 ▣ 176 V	N3.3 ▣ 88 V								

DCON MS tolerancia h6.

Product	DC (inch)	DC (mm)	DC (inch)	LCF (mm)	OAL (mm)	LS (mm)	DCON MS (mm)
R4593.0	–	3.00	0.1181	37.0	79.0	36.0	6.00
R4593.1	–	3.10	0.1220	37.0	79.0	36.0	6.00
R4591/8	1/8	3.18	0.1250	37.0	79.0	36.0	6.00
R4593.2	–	3.20	0.1260	37.0	79.0	36.0	6.00
R4593.3	–	3.30	0.1299	37.0	79.0	36.0	6.00
R4593.4	–	3.40	0.1339	37.0	79.0	36.0	6.00
R4593.5	–	3.50	0.1378	37.0	79.0	36.0	6.00
R4599/64	9/64	3.57	0.1406	37.0	79.0	36.0	6.00
R4593.6	–	3.60	0.1417	37.0	79.0	36.0	6.00
R4593.7	–	3.70	0.1457	37.0	79.0	36.0	6.00
R4593.8	–	3.80	0.1496	48.0	90.0	36.0	6.00
R4593.9	–	3.90	0.1535	48.0	90.0	36.0	6.00
R4595/32	5/32	3.97	0.1563	48.0	90.0	36.0	6.00
R4594.0	–	4.00	0.1575	48.0	90.0	36.0	6.00
R4594.1	–	4.10	0.1614	48.0	90.0	36.0	6.00
R4594.2	–	4.20	0.1654	48.0	90.0	36.0	6.00
R4594.3	–	4.30	0.1693	48.0	90.0	36.0	6.00
R45911/64	11/64	4.37	0.1719	48.0	90.0	36.0	6.00
R4594.4	–	4.40	0.1732	48.0	90.0	36.0	6.00
R4594.5	–	4.50	0.1772	48.0	90.0	36.0	6.00
R4594.6	–	4.60	0.1811	48.0	90.0	36.0	6.00
R4594.7	–	4.70	0.1850	62.0	104.0	36.0	6.00
R4593/16	3/16	4.76	0.1875	62.0	104.0	36.0	6.00
R4594.8	–	4.80	0.1890	62.0	104.0	36.0	6.00
R4594.9	–	4.90	0.1929	62.0	104.0	36.0	6.00

Product	DC	DC	DC	LCF	OAL	LS	DCON MS
	(inch)	(mm)	(inch)	(mm)	(mm)	(mm)	(mm)
R4595.0	–	5.00	0.1969	62.0	104.0	36.0	6.00
R4595.1	–	5.10	0.2008	62.0	104.0	36.0	6.00
R45913/64	13/64	5.16	0.2031	62.0	104.0	36.0	6.00
R4595.2	–	5.20	0.2047	62.0	104.0	36.0	6.00
R4595.3	–	5.30	0.2087	62.0	104.0	36.0	6.00
R4595.4	–	5.40	0.2126	62.0	104.0	36.0	6.00
R4595.5	–	5.50	0.2165	62.0	104.0	36.0	6.00
R4597/32	7/32	5.56	0.2188	62.0	104.0	36.0	6.00
R4595.6	–	5.60	0.2205	62.0	104.0	36.0	6.00
R4595.7	–	5.70	0.2244	62.0	104.0	36.0	6.00
R4595.8	–	5.80	0.2283	62.0	104.0	36.0	6.00
R4595.9	–	5.90	0.2323	62.0	104.0	36.0	6.00
R45915/64	15/64	5.95	0.2344	62.0	104.0	36.0	6.00
R4596.0	–	6.00	0.2362	62.0	104.0	36.0	6.00
R4596.1	–	6.10	0.2402	84.0	126.0	36.0	8.00
R4596.2	–	6.20	0.2441	84.0	126.0	36.0	8.00
R4596.3	–	6.30	0.2480	84.0	126.0	36.0	8.00
R4591/4	1/4	6.35	0.2500	84.0	126.0	36.0	8.00
R4596.4	–	6.40	0.2520	84.0	126.0	36.0	8.00
R4596.5	–	6.50	0.2559	84.0	126.0	36.0	8.00
R4596.6	–	6.60	0.2598	84.0	126.0	36.0	8.00
R4596.7	–	6.70	0.2638	84.0	126.0	36.0	8.00
R45917/64	17/64	6.75	0.2656	84.0	126.0	36.0	8.00
R4596.8	–	6.80	0.2677	84.0	126.0	36.0	8.00
R4596.9	–	6.90	0.2717	84.0	126.0	36.0	8.00
R4597.0	–	7.00	0.2756	84.0	126.0	36.0	8.00
R4597.1	–	7.10	0.2795	84.0	126.0	36.0	8.00
R4599/32	9/32	7.14	0.2813	84.0	126.0	36.0	8.00
R4597.2	–	7.20	0.2835	84.0	126.0	36.0	8.00
R4597.3	–	7.30	0.2874	84.0	126.0	36.0	8.00
R4597.4	–	7.40	0.2913	84.0	126.0	36.0	8.00
R4597.5	–	7.50	0.2953	84.0	126.0	36.0	8.00
R45919/64	19/64	7.54	0.2969	84.0	126.0	36.0	8.00
R4597.6	–	7.60	0.2992	84.0	126.0	36.0	8.00
R4597.7	–	7.70	0.3031	84.0	126.0	36.0	8.00
R4597.8	–	7.80	0.3071	84.0	126.0	36.0	8.00
R4597.9	–	7.90	0.3110	84.0	126.0	36.0	8.00
R4595/16	5/16	7.94	0.3125	84.0	126.0	36.0	8.00
R4598.0	–	8.00	0.3150	84.0	126.0	36.0	8.00
R4598.1	–	8.10	0.3189	106.0	152.0	40.0	10.00
R4598.2	–	8.20	0.3228	106.0	152.0	40.0	10.00
R4598.3	–	8.30	0.3268	106.0	152.0	40.0	10.00
R45921/64	21/64	8.33	0.3281	106.0	152.0	40.0	10.00
R4598.4	–	8.40	0.3307	106.0	152.0	40.0	10.00
R4598.5	–	8.50	0.3346	106.0	152.0	40.0	10.00
R4598.6	–	8.60	0.3386	106.0	152.0	40.0	10.00
R4598.7	–	8.70	0.3425	106.0	152.0	40.0	10.00
R45911/32	11/32	8.73	0.3438	106.0	152.0	40.0	10.00
R4598.8	–	8.80	0.3465	106.0	152.0	40.0	10.00
R4598.9	–	8.90	0.3504	106.0	152.0	40.0	10.00
R4599.0	–	9.00	0.3543	106.0	152.0	40.0	10.00
R4599.1	–	9.10	0.3583	106.0	152.0	40.0	10.00
R45923/64	23/64	9.13	0.3594	106.0	152.0	40.0	10.00
R4599.2	–	9.20	0.3622	106.0	152.0	40.0	10.00
R4599.3	–	9.30	0.3661	106.0	152.0	40.0	10.00
R4599.4	–	9.40	0.3701	106.0	152.0	40.0	10.00
R4599.5	–	9.50	0.3740	106.0	152.0	40.0	10.00
R4593/8	3/8	9.53	0.3750	106.0	152.0	40.0	10.00
R4599.6	–	9.60	0.3780	106.0	152.0	40.0	10.00
R4599.7	–	9.70	0.3819	106.0	152.0	40.0	10.00
R4599.8	–	9.80	0.3858	106.0	152.0	40.0	10.00
R4599.9	–	9.90	0.3898	106.0	152.0	40.0	10.00



Product	DC	DC	DC	LCF	OAL	LS	DCON MS
	(inch)	(mm)	(inch)	(mm)	(mm)	(mm)	(mm)
R45925/64	25/64	9.92	0.3906	106.0	152.0	40.0	10.00
R45910.0	–	10.00	0.3937	106.0	152.0	40.0	10.00
R45910.2	–	10.20	0.4016	128.0	180.0	45.0	12.00
R45910.3	–	10.30	0.4055	128.0	180.0	45.0	12.00
R45913/32	13/32	10.32	0.4063	128.0	180.0	45.0	12.00
R45910.4	–	10.40	0.4094	128.0	180.0	45.0	12.00
R45910.5	–	10.50	0.4134	128.0	180.0	45.0	12.00
R45927/64	27/64	10.72	0.4219	128.0	180.0	45.0	12.00
R45910.8	–	10.80	0.4252	128.0	180.0	45.0	12.00
R45911.0	–	11.00	0.4331	128.0	180.0	45.0	12.00
R4597/16	7/16	11.11	0.4375	128.0	180.0	45.0	12.00
R45911.2	–	11.20	0.4409	128.0	180.0	45.0	12.00
R45911.3	–	11.30	0.4449	128.0	180.0	45.0	12.00
R45911.5	–	11.50	0.4528	128.0	180.0	45.0	12.00
R45929/64	29/64	11.51	0.4531	128.0	180.0	45.0	12.00
R45911.8	–	11.80	0.4646	128.0	180.0	45.0	12.00
R45915/32	15/32	11.91	0.4688	128.0	180.0	45.0	12.00
R45912.0	–	12.00	0.4724	128.0	180.0	45.0	12.00
R45912.2	–	12.20	0.4803	151.0	202.0	48.0	14.00
R45931/64	31/64	12.30	0.4844	151.0	202.0	48.0	14.00
R45912.5	–	12.50	0.4921	151.0	202.0	48.0	14.00
R4591/2	1/2	12.70	0.5000	151.0	202.0	48.0	14.00
R45912.8	–	12.80	0.5039	151.0	202.0	48.0	14.00
R45913.0	–	13.00	0.5118	151.0	202.0	48.0	14.00
R45933/64	33/64	13.10	0.5156	151.0	202.0	48.0	14.00
R45917/32	17/32	13.49	0.5313	151.0	202.0	48.0	14.00
R45913.5	–	13.50	0.5315	151.0	202.0	48.0	14.00
R45935/64	35/64	13.89	0.5469	151.0	202.0	48.0	14.00
R45914.0	–	14.00	0.5512	151.0	202.0	48.0	14.00
R45914.25	–	14.25	0.5610	172.0	227.0	48.0	16.00
R4599/16	9/16	14.29	0.5625	172.0	227.0	48.0	16.00
R45914.5	–	14.50	0.5709	172.0	227.0	48.0	16.00
R45937/64	37/64	14.68	0.5781	172.0	227.0	48.0	16.00
R45915.0	–	15.00	0.5906	172.0	227.0	48.0	16.00
R45919/32	19/32	15.08	0.5938	172.0	227.0	48.0	16.00
R45915.1	–	15.10	0.5945	172.0	227.0	48.0	16.00
R45915.5	–	15.50	0.6102	172.0	227.0	48.0	16.00
R4595/8	5/8	15.88	0.6250	172.0	227.0	48.0	16.00
R45916.0	–	16.00	0.6299	172.0	227.0	48.0	16.00

R467



Broca FORCE M, Metal Duro 3XD, con Refrigeración Interna, con Recubrimiento TiAlN

Broca de alto rendimiento, capaz de producir agujeros precisos y de alta calidad a altas velocidades y avances (tolerancia de agujero H9 en acero inoxidable y materiales termoresistentes). Punta dividida de 4 facetas a 140 ° y alma continuamente adelgazada (CTW). Los agujeros de refrigeración permiten mejorar la evacuación de virutas. El recubrimiento TiN aumenta la dureza superficial y prolonga la vida de la herramienta.

FORCE M

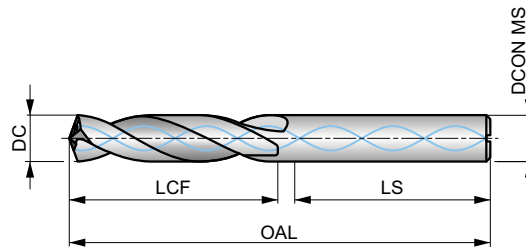

HM	DIN 6537K	3xD
140°	TiAlN	DIN 6535HA
CTW	R	Internal Cooling
DC m7		

Grupo de Material de la pieza adecuado y condiciones de velocidad de corte iniciales (m/min) y código de avance alfabético. Tablas con avance por revolución a partir de la pag.274.

M1.1 ■ 117 G	M1.2 ■ 99 G	M2.1 ■ 104 G	M2.2 ■ 85 G	M2.3 ■ 71 E	M3.1 ■ 87 G	M3.2 ■ 75 G	M3.3 ■ 68 F	M4.1 ■ 60 F	M4.2 ■ 52 E	S1.1 ■ 55 V	S1.2 ■ 45 V	S1.3 ■ 40 U	S2.1 ■ 60 U
S2.2 ■ 56 U	S3.1 ■ 45 U	S3.2 ■ 40 U	S4.1 ■ 35 U	S4.2 ■ 32 U									

DCON MS tolerancia h6.

Product	DC (inch)	DC (mm)	DC (inch)	LCF (mm)	OAL (mm)	LS (mm)	DCON MS (mm)
R4673.0	–	3.00	0.1181	20.0	62.0	36.0	6.00
R4673.1	–	3.10	0.1220	20.0	62.0	36.0	6.00
R4671/8	1/8	3.18	0.1250	20.0	62.0	36.0	6.00
R4673.2	–	3.20	0.1260	20.0	62.0	36.0	6.00
R4673.3	–	3.30	0.1299	20.0	62.0	36.0	6.00
R4673.4	–	3.40	0.1339	20.0	62.0	36.0	6.00
R467N29	N29	3.45	0.1360	20.0	62.0	36.0	6.00
R4673.5	–	3.50	0.1378	20.0	62.0	36.0	6.00
R4679/64	9/64	3.57	0.1406	20.0	62.0	36.0	6.00
R4673.6	–	3.60	0.1417	20.0	62.0	36.0	6.00
R4673.7	–	3.70	0.1457	20.0	62.0	36.0	6.00
R4673.8	–	3.80	0.1496	24.0	66.0	36.0	6.00
R4673.9	–	3.90	0.1535	24.0	66.0	36.0	6.00
R4675/32	5/32	3.97	0.1563	24.0	66.0	36.0	6.00
R4674.0	–	4.00	0.1575	24.0	66.0	36.0	6.00
R4674.05	–	4.05	0.1594	24.0	66.0	36.0	6.00
R4674.1	–	4.10	0.1614	24.0	66.0	36.0	6.00
R4674.2	–	4.20	0.1654	24.0	66.0	36.0	6.00
R4674.3	–	4.30	0.1693	24.0	66.0	36.0	6.00
R46711/64	11/64	4.37	0.1719	24.0	66.0	36.0	6.00
R4674.4	–	4.40	0.1732	24.0	66.0	36.0	6.00
R4674.5	–	4.50	0.1772	24.0	66.0	36.0	6.00
R4674.6	–	4.60	0.1811	24.0	66.0	36.0	6.00
R4674.7	–	4.70	0.1850	24.0	66.0	36.0	6.00
R4673/16	3/16	4.76	0.1875	28.0	66.0	36.0	6.00
R4674.8	–	4.80	0.1890	28.0	66.0	36.0	6.00
R4674.9	–	4.90	0.1929	28.0	66.0	36.0	6.00
R4675.0	–	5.00	0.1969	28.0	66.0	36.0	6.00
R4675.05	–	5.05	0.1988	28.0	66.0	36.0	6.00

Product	DC	DC	DC	LCF	OAL	LS	DCON MS
	(inch)	(mm)	(inch)	(mm)	(mm)	(mm)	(mm)
R4675.1	–	5.10	0.2008	28.0	66.0	36.0	6.00
R467N7	N7	5.11	0.2010	28.0	66.0	36.0	6.00
R46713/64	13/64	5.16	0.2031	28.0	66.0	36.0	6.00
R4675.2	–	5.20	0.2047	28.0	66.0	36.0	6.00
R467N5	N5	5.22	0.2055	28.0	66.0	36.0	6.00
R4675.3	–	5.30	0.2087	28.0	66.0	36.0	6.00
R4675.4	–	5.40	0.2126	28.0	66.0	36.0	6.00
R4675.5	–	5.50	0.2165	28.0	66.0	36.0	6.00
R4677/32	7/32	5.56	0.2188	28.0	66.0	36.0	6.00
R4675.6	–	5.60	0.2205	28.0	66.0	36.0	6.00
R4675.7	–	5.70	0.2244	28.0	66.0	36.0	6.00
R4675.8	–	5.80	0.2283	28.0	66.0	36.0	6.00
R4675.9	–	5.90	0.2323	28.0	66.0	36.0	6.00
R46715/64	15/64	5.95	0.2344	28.0	66.0	36.0	6.00
R4676.0	–	6.00	0.2362	28.0	66.0	36.0	6.00
R4676.05	–	6.05	0.2382	34.0	79.0	36.0	8.00
R4676.1	–	6.10	0.2402	34.0	79.0	36.0	8.00
R4676.2	–	6.20	0.2441	34.0	79.0	36.0	8.00
R4676.3	–	6.30	0.2480	34.0	79.0	36.0	8.00
R4671/4	1/4	6.35	0.2500	34.0	79.0	36.0	8.00
R4676.4	–	6.40	0.2520	34.0	79.0	36.0	8.00
R4676.5	–	6.50	0.2559	34.0	79.0	36.0	8.00
R4676.6	–	6.60	0.2598	34.0	79.0	36.0	8.00
R4676.7	–	6.70	0.2638	34.0	79.0	36.0	8.00
R46717/64	17/64	6.75	0.2656	34.0	79.0	36.0	8.00
R4676.8	–	6.80	0.2677	34.0	79.0	36.0	8.00
R4676.9	–	6.90	0.2717	34.0	79.0	36.0	8.00
R4677.0	–	7.00	0.2756	34.0	79.0	36.0	8.00
R4677.1	–	7.10	0.2795	41.0	79.0	36.0	8.00
R4679/32	9/32	7.14	0.2813	41.0	79.0	36.0	8.00
R4677.2	–	7.20	0.2835	41.0	79.0	36.0	8.00
R4677.3	–	7.30	0.2874	41.0	79.0	36.0	8.00
R4677.4	–	7.40	0.2913	41.0	79.0	36.0	8.00
R4677.5	–	7.50	0.2953	41.0	79.0	36.0	8.00
R46719/64	19/64	7.54	0.2969	41.0	79.0	36.0	8.00
R4677.6	–	7.60	0.2992	41.0	79.0	36.0	8.00
R4677.7	–	7.70	0.3031	41.0	79.0	36.0	8.00
R4677.8	–	7.80	0.3071	41.0	79.0	36.0	8.00
R4675/16	5/16	7.94	0.3125	41.0	79.0	36.0	8.00
R4678.0	–	8.00	0.3150	41.0	79.0	36.0	8.00
R4678.05	–	8.05	0.3169	47.0	89.0	40.0	10.00
R4678.1	–	8.10	0.3189	47.0	89.0	40.0	10.00
R4678.2	–	8.20	0.3228	47.0	89.0	40.0	10.00
R4678.3	–	8.30	0.3268	47.0	89.0	40.0	10.00
R4678.4	–	8.40	0.3307	47.0	89.0	40.0	10.00
R4678.5	–	8.50	0.3346	47.0	89.0	40.0	10.00
R4678.6	–	8.60	0.3386	47.0	89.0	40.0	10.00
R4678.7	–	8.70	0.3425	47.0	89.0	40.0	10.00
R46711/32	11/32	8.73	0.3438	47.0	89.0	40.0	10.00
R4678.8	–	8.80	0.3465	47.0	89.0	40.0	10.00
R4678.9	–	8.90	0.3504	47.0	89.0	40.0	10.00
R4679.0	–	9.00	0.3543	47.0	89.0	40.0	10.00
R4679.1	–	9.10	0.3583	47.0	89.0	40.0	10.00
R46723/64	23/64	9.13	0.3594	47.0	89.0	40.0	10.00
R4679.3	–	9.30	0.3661	47.0	89.0	40.0	10.00
R4679.4	–	9.40	0.3701	47.0	89.0	40.0	10.00
R4679.5	–	9.50	0.3740	47.0	89.0	40.0	10.00
R4673/8	3/8	9.53	0.3750	47.0	89.0	40.0	10.00
R4679.6	–	9.60	0.3780	47.0	89.0	40.0	10.00
R4679.7	–	9.70	0.3819	47.0	89.0	40.0	10.00
R4679.8	–	9.80	0.3858	47.0	89.0	40.0	10.00
R4679.9	–	9.90	0.3898	47.0	89.0	40.0	10.00

Product	DC	DC	DC	LCF	OAL	LS	DCON MS
	(inch)	(mm)	(inch)	(mm)	(mm)	(mm)	(mm)
R46725/64	25/64	9.92	0.3906	47.0	89.0	40.0	10.00
R46710.0	–	10.00	0.3937	47.0	89.0	40.0	10.00
R46710.05	–	10.05	0.3957	55.0	102.0	45.0	12.00
R46710.1	–	10.10	0.3976	55.0	102.0	45.0	12.00
R46710.2	–	10.20	0.4016	55.0	102.0	45.0	12.00
R46710.3	–	10.30	0.4055	55.0	102.0	45.0	12.00
R46713/32	13/32	10.32	0.4063	55.0	102.0	45.0	12.00
R46710.4	–	10.40	0.4094	55.0	102.0	45.0	12.00
R46710.5	–	10.50	0.4134	55.0	102.0	45.0	12.00
R46710.6	–	10.60	0.4173	55.0	102.0	45.0	12.00
R46727/64	27/64	10.72	0.4219	55.0	102.0	45.0	12.00
R46710.9	–	10.90	0.4291	55.0	102.0	45.0	12.00
R46711.0	–	11.00	0.4331	55.0	102.0	45.0	12.00
R4677/16	7/16	11.11	0.4375	55.0	102.0	45.0	12.00
R46711.2	–	11.20	0.4409	55.0	102.0	45.0	12.00
R46711.4	–	11.40	0.4488	55.0	102.0	45.0	12.00
R46711.5	–	11.50	0.4528	55.0	102.0	45.0	12.00
R46729/64	29/64	11.51	0.4531	55.0	102.0	45.0	12.00
R46711.8	–	11.80	0.4646	55.0	102.0	45.0	12.00
R46715/32	15/32	11.91	0.4688	55.0	102.0	45.0	12.00
R46712.0	–	12.00	0.4724	55.0	102.0	45.0	12.00
R46712.05	–	12.05	0.4744	60.0	107.0	45.0	14.00
R46712.1	–	12.10	0.4764	60.0	107.0	45.0	14.00
R46712.2	–	12.20	0.4803	60.0	107.0	45.0	14.00
R46731/64	31/64	12.30	0.4844	60.0	107.0	45.0	14.00
R46712.5	–	12.50	0.4921	60.0	107.0	45.0	14.00
R46712.7	–	12.70	0.5000	60.0	107.0	45.0	14.00
R4671/2	1/2	12.70	0.5000	60.0	107.0	45.0	14.00
R46713.0	–	13.00	0.5118	60.0	107.0	45.0	14.00
R46733/64	33/64	13.10	0.5156	60.0	107.0	45.0	14.00
R46717/32	17/32	13.49	0.5313	60.0	107.0	45.0	14.00
R46713.5	–	13.50	0.5315	60.0	107.0	45.0	14.00
R46735/64	35/64	13.89	0.5469	60.0	107.0	45.0	14.00
R46714.0	–	14.00	0.5512	60.0	107.0	45.0	14.00
R46714.25	–	14.25	0.5610	65.0	115.0	48.0	16.00
R4679/16	9/16	14.29	0.5625	65.0	115.0	48.0	16.00
R46714.5	–	14.50	0.5709	65.0	115.0	48.0	16.00
R46737/64	37/64	14.68	0.5781	65.0	115.0	48.0	16.00
R46715.0	–	15.00	0.5906	65.0	115.0	48.0	16.00
R46719/32	19/32	15.08	0.5938	65.0	115.0	48.0	16.00
R46715.1	–	15.10	0.5945	65.0	115.0	48.0	16.00
R46715.3	–	15.30	0.6024	65.0	115.0	48.0	16.00
R46715.5	–	15.50	0.6102	65.0	115.0	48.0	16.00
R4675/8	5/8	15.88	0.6250	65.0	115.0	48.0	16.00
R46716.0	–	16.00	0.6299	65.0	115.0	48.0	16.00

R463



Broca FORCE M, Metal Duro 5XD, con Refrigeración Interna, con Recubrimiento TiAlN

Broca de alto rendimiento, capaz de producir agujeros precisos y de alta calidad a altas velocidades y avances (tolerancia de agujero H9 en acero inoxidable y materiales termoresistentes). Punta dividida de 4 facetas a 140 ° y alma continuamente adelgazada (CTW). Los agujeros de refrigeración permiten mejorar la evacuación de virutas. El recubrimiento TiN aumenta la dureza superficial y prolonga la vida de la herramienta.

FORCE M

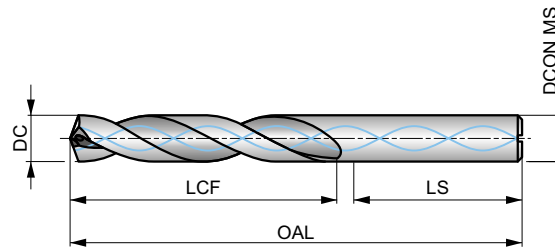

HM	DIN 6537L	5xD
140°	TiAlN	DIN 6535HA
CTW	R	Internal Cooling
DC m7		

Grupo de Material de la pieza adecuado y condiciones de velocidad de corte iniciales (m/min) y código de avance alfabético. Tablas con avance por revolución a partir de la pag.274.

M1.1 ■ 111 G	M1.2 ■ 94 G	M2.1 ■ 99 G	M2.2 ■ 81 G	M2.3 ■ 67 E	M3.1 ■ 83 G	M3.2 ■ 71 G	M3.3 ■ 65 F	M4.1 ■ 57 F	M4.2 ■ 49 E	S1.1 ■ 52 V	S1.2 ■ 43 V	S1.3 ■ 38 U	S2.1 ■ 57 U
S2.2 ■ 53 U	S3.1 ■ 43 U	S3.2 ■ 38 U	S4.1 ■ 33 U	S4.2 ■ 30 U									

DCON MS tolerancia h6.

Product	DC (inch)	DC (mm)	DC (inch)	LCF (mm)	OAL (mm)	LS (mm)	DCON MS (mm)
R4633.0	–	3.00	0.1181	28.0	66.0	36.0	6.00
R4633.1	–	3.10	0.1220	28.0	66.0	36.0	6.00
R4631/8	1/8	3.18	0.1250	28.0	66.0	36.0	6.00
R4633.2	–	3.20	0.1260	28.0	66.0	36.0	6.00
R4633.3	–	3.30	0.1299	28.0	66.0	36.0	6.00
R4633.4	–	3.40	0.1339	28.0	66.0	36.0	6.00
R463N29	N29	3.45	0.1360	28.0	66.0	36.0	6.00
R4633.5	–	3.50	0.1378	28.0	66.0	36.0	6.00
R4639/64	9/64	3.57	0.1406	28.0	66.0	36.0	6.00
R4633.6	–	3.60	0.1417	28.0	66.0	36.0	6.00
R4633.7	–	3.70	0.1457	28.0	66.0	36.0	6.00
R4633.8	–	3.80	0.1496	36.0	74.0	36.0	6.00
R4633.9	–	3.90	0.1535	36.0	74.0	36.0	6.00
R4635/32	5/32	3.97	0.1563	36.0	74.0	36.0	6.00
R4634.0	–	4.00	0.1575	36.0	74.0	36.0	6.00
R4634.05	–	4.05	0.1594	36.0	74.0	36.0	6.00
R4634.1	–	4.10	0.1614	36.0	74.0	36.0	6.00
R4634.2	–	4.20	0.1654	36.0	74.0	36.0	6.00
R4634.3	–	4.30	0.1693	36.0	74.0	36.0	6.00
R46311/64	11/64	4.37	0.1719	36.0	74.0	36.0	6.00
R4634.4	–	4.40	0.1732	36.0	74.0	36.0	6.00
R4634.5	–	4.50	0.1772	36.0	74.0	36.0	6.00
R4634.6	–	4.60	0.1811	36.0	74.0	36.0	6.00
R4634.7	–	4.70	0.1850	36.0	74.0	36.0	6.00
R4633/16	3/16	4.76	0.1875	44.0	82.0	36.0	6.00
R4634.8	–	4.80	0.1890	44.0	82.0	36.0	6.00
R4634.9	–	4.90	0.1929	44.0	82.0	36.0	6.00
R4635.0	–	5.00	0.1969	44.0	82.0	36.0	6.00
R4635.05	–	5.05	0.1988	44.0	82.0	36.0	6.00

Product	DC	DC	DC	LCF	OAL	LS	DCON MS
	(inch)	(mm)	(inch)	(mm)	(mm)	(mm)	(mm)
R4635.1	–	5.10	0.2008	44.0	82.0	36.0	6.00
R463N7	N7	5.11	0.2010	44.0	82.0	36.0	6.00
R46313/64	13/64	5.16	0.2031	44.0	82.0	36.0	6.00
R4635.2	–	5.20	0.2047	44.0	82.0	36.0	6.00
R463N5	N5	5.22	0.2055	44.0	82.0	36.0	6.00
R4635.3	–	5.30	0.2087	44.0	82.0	36.0	6.00
R4635.5	–	5.50	0.2165	44.0	82.0	36.0	6.00
R4637/32	7/32	5.56	0.2188	44.0	82.0	36.0	6.00
R4635.6	–	5.60	0.2205	44.0	82.0	36.0	6.00
R4635.7	–	5.70	0.2244	44.0	82.0	36.0	6.00
R4635.8	–	5.80	0.2283	44.0	82.0	36.0	6.00
R4635.9	–	5.90	0.2323	44.0	82.0	36.0	6.00
R46315/64	15/64	5.95	0.2344	44.0	82.0	36.0	6.00
R4636.0	–	6.00	0.2362	44.0	82.0	36.0	6.00
R4636.05	–	6.05	0.2382	53.0	91.0	36.0	8.00
R4636.1	–	6.10	0.2402	53.0	91.0	36.0	8.00
R4636.2	–	6.20	0.2441	53.0	91.0	36.0	8.00
R4636.3	–	6.30	0.2480	53.0	91.0	36.0	8.00
R4631/4	1/4	6.35	0.2500	53.0	91.0	36.0	8.00
R4636.4	–	6.40	0.2520	53.0	91.0	36.0	8.00
R4636.5	–	6.50	0.2559	53.0	91.0	36.0	8.00
R4636.6	–	6.60	0.2598	53.0	91.0	36.0	8.00
R4636.7	–	6.70	0.2638	53.0	91.0	36.0	8.00
R46317/64	17/64	6.75	0.2656	53.0	91.0	36.0	8.00
R4636.8	–	6.80	0.2677	53.0	91.0	36.0	8.00
R4636.9	–	6.90	0.2717	53.0	91.0	36.0	8.00
R4637.0	–	7.00	0.2756	53.0	91.0	36.0	8.00
R4637.1	–	7.10	0.2795	53.0	91.0	36.0	8.00
R4637.2	–	7.20	0.2835	53.0	91.0	36.0	8.00
R4637.3	–	7.30	0.2874	53.0	91.0	36.0	8.00
R4637.4	–	7.40	0.2913	53.0	91.0	36.0	8.00
R4637.5	–	7.50	0.2953	53.0	91.0	36.0	8.00
R4637.6	–	7.60	0.2992	53.0	91.0	36.0	8.00
R4637.7	–	7.70	0.3031	53.0	91.0	36.0	8.00
R4637.8	–	7.80	0.3071	53.0	91.0	36.0	8.00
R4637.9	–	7.90	0.3110	53.0	91.0	36.0	8.00
R4635/16	5/16	7.94	0.3125	53.0	91.0	36.0	8.00
R4638.0	–	8.00	0.3150	53.0	91.0	36.0	8.00
R4638.05	–	8.05	0.3169	61.0	103.0	40.0	10.00
R4638.1	–	8.10	0.3189	61.0	103.0	40.0	10.00
R4638.2	–	8.20	0.3228	61.0	103.0	40.0	10.00
R4638.3	–	8.30	0.3268	61.0	103.0	40.0	10.00
R46321/64	21/64	8.33	0.3281	61.0	103.0	40.0	10.00
R4638.4	–	8.40	0.3307	61.0	103.0	40.0	10.00
R4638.5	–	8.50	0.3346	61.0	103.0	40.0	10.00
R4638.6	–	8.60	0.3386	61.0	103.0	40.0	10.00
R4638.7	–	8.70	0.3425	61.0	103.0	40.0	10.00
R46311/32	11/32	8.73	0.3438	61.0	103.0	40.0	10.00
R4638.8	–	8.80	0.3465	61.0	103.0	40.0	10.00
R4638.9	–	8.90	0.3504	61.0	103.0	40.0	10.00
R4639.0	–	9.00	0.3543	61.0	103.0	40.0	10.00
R4639.1	–	9.10	0.3583	61.0	103.0	40.0	10.00
R46323/64	23/64	9.13	0.3594	61.0	103.0	40.0	10.00
R4639.2	–	9.20	0.3622	61.0	103.0	40.0	10.00
R4639.3	–	9.30	0.3661	61.0	103.0	40.0	10.00
R4639.4	–	9.40	0.3701	61.0	103.0	40.0	10.00
R4639.5	–	9.50	0.3740	61.0	103.0	40.0	10.00
R4633/8	3/8	9.53	0.3750	61.0	103.0	40.0	10.00
R4639.6	–	9.60	0.3780	61.0	103.0	40.0	10.00
R4639.7	–	9.70	0.3819	61.0	103.0	40.0	10.00
R4639.8	–	9.80	0.3858	61.0	103.0	40.0	10.00
R4639.9	–	9.90	0.3898	61.0	103.0	40.0	10.00

Product	DC	DC	DC	LCF	OAL	LS	DCON MS
	(inch)	(mm)	(inch)	(mm)	(mm)	(mm)	(mm)
R46310.0	–	10.00	0.3937	61.0	103.0	40.0	10.00
R46310.05	–	10.05	0.3957	70.0	118.0	45.0	12.00
R46310.1	–	10.10	0.3976	70.0	118.0	45.0	12.00
R46310.2	–	10.20	0.4016	70.0	118.0	45.0	12.00
R46310.3	–	10.30	0.4055	70.0	118.0	45.0	12.00
R46313/32	13/32	10.32	0.4063	70.0	118.0	45.0	12.00
R46310.4	–	10.40	0.4094	70.0	118.0	45.0	12.00
R46310.5	–	10.50	0.4134	70.0	118.0	45.0	12.00
R46327/64	27/64	10.72	0.4219	70.0	118.0	45.0	12.00
R46310.8	–	10.80	0.4252	70.0	118.0	45.0	12.00
R46311.0	–	11.00	0.4331	70.0	118.0	45.0	12.00
R4637/16	7/16	11.11	0.4375	70.0	118.0	45.0	12.00
R46311.2	–	11.20	0.4409	70.0	118.0	45.0	12.00
R46311.3	–	11.30	0.4449	70.0	118.0	45.0	12.00
R46311.4	–	11.40	0.4488	70.0	118.0	45.0	12.00
R46311.5	–	11.50	0.4528	70.0	118.0	45.0	12.00
R46329/64	29/64	11.51	0.4531	70.0	118.0	45.0	12.00
R46311.6	–	11.60	0.4567	70.0	118.0	45.0	12.00
R46311.8	–	11.80	0.4646	70.0	118.0	45.0	12.00
R46315/32	15/32	11.91	0.4688	70.0	118.0	45.0	12.00
R46312.0	–	12.00	0.4724	70.0	118.0	45.0	12.00
R46312.05	–	12.05	0.4744	76.0	124.0	45.0	14.00
R46312.2	–	12.20	0.4803	76.0	124.0	45.0	14.00
R46331/64	31/64	12.30	0.4844	76.0	124.0	45.0	14.00
R46312.5	–	12.50	0.4921	76.0	124.0	45.0	14.00
R46312.7	–	12.70	0.5000	76.0	124.0	45.0	14.00
R4631/2	1/2	12.70	0.5000	76.0	124.0	45.0	14.00
R46312.8	–	12.80	0.5039	76.0	124.0	45.0	14.00
R46313.0	–	13.00	0.5118	76.0	124.0	45.0	14.00
R46333/64	33/64	13.10	0.5156	76.0	124.0	45.0	14.00
R46313.5	–	13.50	0.5315	76.0	124.0	45.0	14.00
R46313.8	–	13.80	0.5433	76.0	124.0	45.0	14.00
R46314.0	–	14.00	0.5512	76.0	124.0	45.0	14.00
R46314.25	–	14.25	0.5610	82.0	133.0	48.0	16.00
R46314.5	–	14.50	0.5709	82.0	133.0	48.0	16.00
R46315.0	–	15.00	0.5906	82.0	133.0	48.0	16.00
R46315.3	–	15.30	0.6024	82.0	133.0	48.0	16.00
R46315.5	–	15.50	0.6102	82.0	133.0	48.0	16.00
R46315.8	–	15.80	0.6220	82.0	133.0	48.0	16.00
R46316.0	–	16.00	0.6299	82.0	133.0	48.0	16.00

R7131



Broca Escalonada de Metal Duro, con Refrigeración Interna, Recubrimiento TiAlN

Versátil, con diámetros y longitudes de piloto específicos para lograr el tamaño y la profundidad de agujero para roscas métricas. Taladrar y achafanar en una sola operación reduce el tiempo de ciclo y el inventario de herramientas. Ángulo de punta de 140° y avellanado de 90°. El recubrimiento TiAlN mejora el rendimiento y prolonga la vida útil de la herramienta. Apta para taladrar muchos materiales.

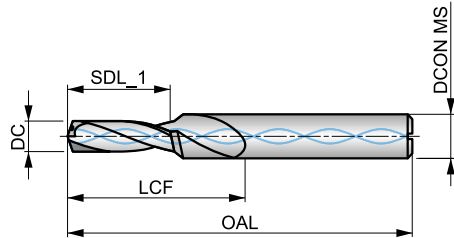

HM	DORMER	3xD
90°	TiAlN	DIN 6535HA
λ 20-35°	R	
DC m7		

Grupo de Material de la pieza adecuado y condiciones de velocidad de corte iniciales (m/min) y código de avance alfabético. Tablas con avance por revolución a partir de la pag.274.

P1.1 ■ 139 W	P1.2 ■ 156 W	P1.3 ■ 161 W	P2.1 ■ 119 W	P2.2 ■ 105 W	P2.3 ■ 93 V	P3.1 ■ 96 V	P3.2 ■ 77 V	P3.3 ■ 65 V	P4.1 ■ 57 V	P4.2 ■ 48 V	M1.1 ■ 62 V	M1.2 ■ 52 V	M2.1 ■ 55 V
M2.2 ■ 45 V	M3.1 ■ 47 V	M3.2 ■ 40 V	M3.3 ■ 36 U	M4.1 ■ 35 U	K1.1 ■ 90 W	K1.2 ■ 67 W	K1.3 ■ 50 W	K2.1 ■ 92 V	K2.2 ■ 75 V	K2.3 ■ 60 V	K3.1 ■ 82 V	K3.2 ■ 62 V	K3.3 ■ 50 V
K4.1 ■ 76 V	K4.2 ■ 57 V	K4.3 ■ 42 V	K4.4 ■ 36 V	K4.5 ■ 30 V	K5.1 ■ 86 V	K5.2 ■ 64 V	K5.3 ■ 50 V	N1.1 ■ 250 W	N1.2 ■ 188 W	N1.3 ■ 125 W	N2.1 ■ 308 V	N2.2 ■ 277 V	N2.3 ■ 200 V
N3.1 ■ 373 W	N3.2 ■ 220 W	N3.3 ■ 110 W											

DCON MS tolerancia h6.

Product	DC (mm)	DC (inch)	SDL_1 (mm)	LCF (mm)	OAL (mm)	DCON MS (mm)	TDZ
R71313.3	3.30	0.1299	11.40	20.0	66.0	6.00	M4
R71314.2	4.20	0.1654	13.60	24.0	66.0	6.00	M5
R71315.0	5.00	0.1969	16.50	28.0	79.0	8.00	M6
R71316.8	6.80	0.2677	21.00	34.0	89.0	10.00	M8
R71318.5	8.50	0.3346	25.50	47.0	102.0	12.00	M10
R713110.2	10.20	0.4016	30.00	55.0	107.0	14.00	M12
R713110.4	10.40	0.4094	30.00	55.0	107.0	14.00	M12

Código de Material (BMC)	HSS	HSS	HSS	HSS	HSS	HM	HM						
Grupo básico estándar (BSG)	DORMER	DORMER	DORMER	DORMER	DORMER	DORMER	DORMER						
Longitud Útil (ULDR)	1.5xD	3xD	5xD	8xD	12xD								
Ángulo de aplicación						140°	140°						
Recubrimiento	Bright Ni	Bright Ni	Bright Ni	Bright Ni	Bright Ni	Ti-phos	Ti-phos						
Mango	ISO 9766	DIN 6535HB DIN 6535HE	DIN 6535HB DIN 6535HE	DIN 6535HB DIN 6535HE									
Mano (dirección de corte)	R	R	R	R	R	R	R						
Refrigeración (CSP)													

Código de Familia de Producto	H851	H853	H855	H858	H8512	R950	R960	H860	H861				
Gama de diámetros de corte PSF	31/64 - 30.00	12.00 - 42.50	12.00 - 42.50	14.00 - 42.50	14.00 - 25.00	15/32 - 42.00	15/32 - 30.50	N1 - N7	N1 - N5				
	218	219	221	223	224	225	227	229	229				

P	P1					■	■						
	P2					■	■						
	P3					■	■						
	P4					■	■						
M	M1						■						
	M2						■						
	M3						■						
	M4						■						
K	K1						■						
	K2					■	■						
	K3					■	■						
	K4					■	■						
	K5					■	■						
N	N1												
	N2												
	N3												
	N4												
	N5												
S	S1						■						
	S2						■						
	S3						■						
	S4						■						
H	H1												
	H2												
	H3												
	H4												

H851



Cuerpo HYDRA 1.5XD, con Refrigeración Interna, Recubrimiento Niquelado Brillante

Se utiliza con cabezas HYDRA R950, R960 y R970. Se pueden utilizar varios diámetros de cabeza con el mismo cuerpo. Los agujeros de refrigerante alineados con las cabezas de corte ofrecen una refrigeración eficiente. El mango con brida evita que la broca se mueva en el soporte. La superficie brillante niquelada protege del óxido y la corrosión y mejora la evacuación de virutas.

HYDRA

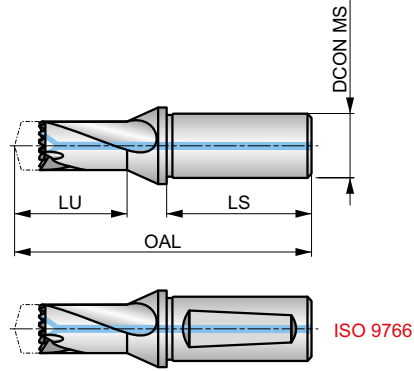

HSS	DORMER	1.5xD
Bright Ni	ISO 9766	R
		

Cuatro (4) tornillos y un (1) destornillador se incluyen en cada cuerpo de broca, DCON MS tolerancia h6.

Product	DCON MS	DCON MS	LU	OAL	LS	ADINTMS
	(inch)	(mm)	(mm)	(mm)	(mm)	
H85131/64	5/8	15.88	25.50	88.5	47.6	Cylindrical
H85117/32	5/8	15.88	30.90	93.9	47.6	Cylindrical
H85112.0	–	16.00	25.50	88.5	48.0	ISO 9766
H85112.5	–	16.00	25.80	88.8	48.0	ISO 9766
H85113.0	–	16.00	27.00	90.0	48.0	ISO 9766
H85114.0	–	16.00	30.90	93.9	48.0	ISO 9766
H85139/64	3/4	19.05	32.30	97.3	50.8	Cylindrical
H85141/64	3/4	19.05	34.90	99.9	50.8	Cylindrical
H85111/16	3/4	19.05	36.40	101.4	50.8	Cylindrical
H85123/32	3/4	19.05	39.00	104.0	50.8	Cylindrical
H85115.0	–	20.00	32.30	97.3	50.0	ISO 9766
H85116.0	–	20.00	34.90	99.9	50.0	ISO 9766
H85117.0	–	20.00	36.40	101.4	50.0	ISO 9766
H85118.0	–	20.00	39.00	104.0	50.0	ISO 9766
H85119.0	–	25.00	40.40	111.4	56.0	ISO 9766
H85120.0	–	25.00	43.00	114.0	56.0	ISO 9766
H85121.0	–	25.00	44.50	115.5	56.0	ISO 9766
H85122.0	–	25.00	46.10	117.1	56.0	ISO 9766
H85123.0	–	25.00	47.00	118.0	56.0	ISO 9766
H85149/64	1"	25.40	40.40	111.4	57.1	Cylindrical
H85151/64	1"	25.40	43.00	114.0	57.1	Cylindrical
H85127/32	1"	25.40	44.50	115.5	57.1	Cylindrical
H85157/64	1"	25.40	46.10	117.1	57.1	Cylindrical
H85159/64	1"	25.40	47.00	118.0	57.1	Cylindrical
H85131/32	1"	25.40	49.30	124.3	57.1	Cylindrical
H8511.1/64	1.1/4	31.75	49.70	124.7	60.3	Cylindrical
H8511.3/64	1.1/4	31.75	52.30	127.3	60.3	Cylindrical
H8511.3/32	1.1/4	31.75	52.80	127.8	60.3	Cylindrical
H8511.3/16	1.1/4	31.75	58.40	133.4	60.3	Cylindrical
H85124.0	–	32.00	49.30	124.3	60.0	ISO 9766
H85125.0	–	32.00	49.70	124.7	60.0	ISO 9766
H85126.0	–	32.00	52.30	127.3	60.0	ISO 9766
H85127.0	–	32.00	52.80	127.8	60.0	ISO 9766
H85128.0	–	32.00	54.40	129.4	60.0	ISO 9766
H85129.0	–	32.00	55.80	130.8	60.0	ISO 9766
H85130.0	–	32.00	58.40	133.4	60.0	ISO 9766

H853



Cuerpo HYDRA 3XD, con Refrigeración Interna, Recubrimiento Niquelado Brillante

Se utiliza con cabezas HYDRA R950, R960 y R970. Se pueden utilizar varios diámetros de cabeza con el mismo cuerpo. Los agujeros de refrigerante alineados con las cabezas de corte ofrecen una refrigeración eficiente. La superficie brillante niquelada protege del óxido y la corrosión y mejora la evacuación de virutas.

HYDRA

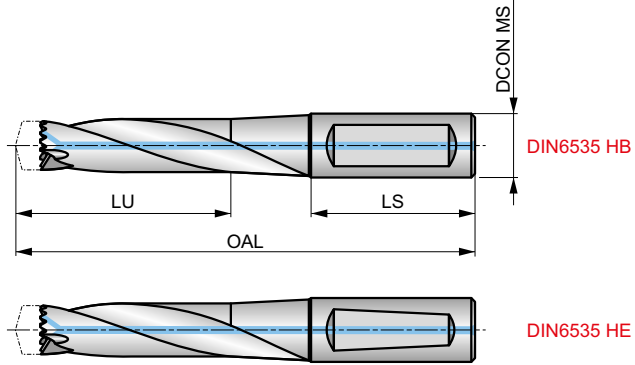

HSS	DORMER	3xD
Bright Ni	DIN 6535HB DIN 6535HE	R

Cuatro (4) tornillos y un (1) destornillador se incluyen en cada cuerpo de broca, DCON MS tolerancia h6.

Product	DCON MS	DCON MS	LU	OAL	LS	ADINTMS
	(inch)	(mm)	(mm)	(mm)	(mm)	
H85312.0	–	16.00	44.00	105.0	48.0	DIN6535HE
H85331/64	5/8	15.88	44.00	105.0	48.0	DIN6535HB
H85312.5	–	16.00	44.00	105.0	48.0	DIN6535HE
H8531/2	5/8	15.88	44.00	105.0	48.0	DIN6535HB
H85313.0	–	16.00	47.00	110.0	48.0	DIN6535HE
H85317/32	5/8	15.88	47.00	110.0	48.0	DIN6535HB
H85314.0	–	16.00	52.50	116.5	48.0	DIN6535HE
H8539/16	3/4	19.05	52.50	116.5	48.0	DIN6535HB
H85315.0	–	20.00	55.50	126.5	50.0	DIN6535HE
H85339/64	3/4	19.05	55.50	126.5	50.0	DIN6535HB
H85316.0	–	20.00	59.50	131.5	50.0	DIN6535HE
H85341/64	3/4	19.05	59.50	131.5	50.0	DIN6535HB
H85317.0	–	20.00	62.50	136.5	50.0	DIN6535HE
H85311/16	3/4	19.05	62.50	136.5	50.0	DIN6535HB
H85318.0	–	20.00	66.50	141.5	50.0	DIN6535HE
H85323/32	3/4	19.05	66.50	141.5	50.0	DIN6535HB
H85319.0	–	25.00	69.50	156.5	56.0	DIN6535HE
H85349/64	1"	25.40	69.50	156.5	56.0	DIN6535HB
H85320.0	–	25.00	73.50	156.5	56.0	DIN6535HE
H85351/64	1"	25.40	73.50	156.5	56.0	DIN6535HB
H85321.0	–	25.00	76.50	156.5	56.0	DIN6535HE
H85327/32	1"	25.40	76.50	156.5	56.0	DIN6535HB
H85322.0	–	25.00	80.10	161.5	56.0	DIN6535HE
H85357/64	1"	25.40	80.10	161.5	56.0	DIN6535HB
H85323.0	–	25.00	82.50	160.5	56.0	DIN6535HE
H85359/64	1"	25.40	82.50	160.5	56.0	DIN6535HB
H85324.0	–	32.00	86.20	170.2	60.0	DIN6535HE
H85331/32	1"	25.40	86.20	170.2	60.0	DIN6535HB
H85325.0	–	32.00	88.00	170.0	60.0	DIN6535HE
H8531.1/64	1.1/4	31.75	88.00	170.0	60.0	DIN6535HB
H85326.0	–	32.00	92.00	175.0	60.0	DIN6535HE
H8531.3/64	1.1/4	31.75	92.00	175.0	60.0	DIN6535HB
H85327.0	–	32.00	94.00	175.0	60.0	DIN6535HE
H8531.3/32	1.1/4	31.75	94.00	175.0	60.0	DIN6535HB



Product	DCON MS	DCON MS	LU	OAL	LS	ADINTMS
	(inch)	(mm)	(mm)	(mm)	(mm)	
H85328.0	–	32.00	97.00	180.0	60.0	DIN6535HE
H8531.1/8	1.1/4	31.75	97.00	180.0	60.0	DIN6535HB
H85329.0	–	32.00	100.00	185.0	60.0	DIN6535HE
H8531.11/64	1.1/4	31.75	100.00	185.0	60.0	DIN6535HB
H85330.0	–	32.00	104.00	185.0	60.0	DIN6535HE
H8531.3/16	1.1/4	31.75	104.00	185.0	60.0	DIN6535HB
H85332.0	–	32.00	111.50	196.5	60.0	DIN6535HE
H85333.5	–	32.00	116.50	201.5	60.0	DIN6535HE
H85335.0	–	40.00	121.50	216.5	70.0	DIN6535HB
H85336.5	–	40.00	125.50	221.5	70.0	DIN6535HB
H85338.0	–	40.00	131.50	226.5	70.0	DIN6535HB
H85339.5	–	40.00	136.50	231.5	70.0	DIN6535HB
H85341.0	–	40.00	146.50	246.5	70.0	DIN6535HB
H85342.5	–	40.00	151.60	251.6	70.0	DIN6535HB

H855



Cuerpo HYDRA 5XD, con Refrigeración Interna, Recubrimiento Niquelado Brillante

Se utiliza con cabezas HYDRA R950, R960 y R970. Se pueden utilizar varios diámetros de cabeza con el mismo cuerpo. Los agujeros de refrigerante alineados con las cabezas de corte ofrecen una refrigeración eficiente. La superficie brillante niquelada protege del óxido y la corrosión y mejora la evacuación de virutas.

HYDRA

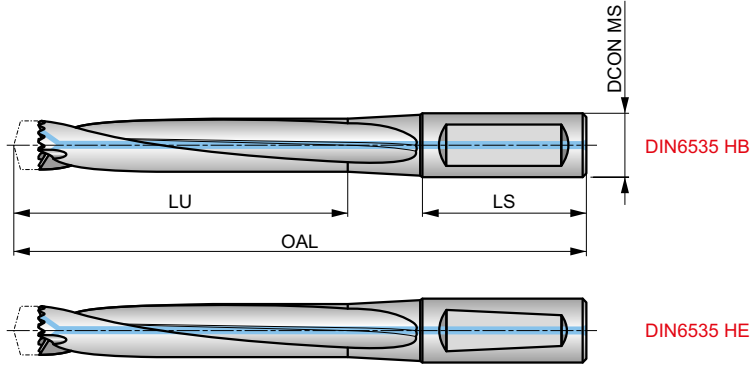

HSS	DORMER	5xD
Bright Ni	DIN 6535HB DIN 6535HE	R

Cuatro (4) tornillos y un (1) destornillador se incluyen en cada cuerpo de broca, DCON MS tolerancia h6.

Product	DCON MS		LU	OAL	LS	ADINTMS
	(inch)	(mm)	(mm)	(mm)	(mm)	
H85512.0	–	16.00	69.00	130.0	48.0	DIN6535HE
H85531/64	5/8	15.88	69.00	130.0	48.0	DIN6535HB
H85512.5	–	16.00	69.00	130.0	48.0	DIN6535HE
H8551/2	5/8	15.88	69.00	130.0	48.0	DIN6535HB
H85513.0	–	16.00	74.00	140.0	48.0	DIN6535HE
H85517/32	5/8	15.88	74.00	140.0	48.0	DIN6535HB
H85514.0	–	16.00	81.50	146.5	48.0	DIN6535HE
H8559/16	3/4	19.05	81.50	146.5	48.0	DIN6535HB
H85515.0	–	20.00	86.50	156.5	50.0	DIN6535HE
H85539/64	3/4	19.05	86.50	156.5	50.0	DIN6535HB
H85516.0	–	20.00	92.50	166.5	50.0	DIN6535HE
H85541/64	3/4	19.05	92.50	166.5	50.0	DIN6535HB
H85517.0	–	20.00	97.50	171.5	50.0	DIN6535HE
H85511/16	3/4	19.05	97.50	171.5	50.0	DIN6535HB
H85518.0	–	20.00	103.50	176.5	50.0	DIN6535HE
H85523/32	3/4	19.05	103.50	176.5	50.0	DIN6535HB
H85519.0	–	25.00	108.50	191.5	56.0	DIN6535HE
H85549/64	1"	25.40	108.50	191.5	56.0	DIN6535HB
H85520.0	–	25.00	114.50	196.5	56.0	DIN6535HE
H85551/64	1"	25.40	114.50	196.5	56.0	DIN6535HB
H85521.0	–	25.00	119.50	196.5	56.0	DIN6535HE
H85527/32	1"	25.40	119.50	196.5	56.0	DIN6535HB
H85522.0	–	25.00	125.10	201.1	56.0	DIN6535HE
H85557/64	1"	25.40	125.10	201.1	56.0	DIN6535HB
H85523.0	–	25.00	129.50	210.5	56.0	DIN6535HE
H85559/64	1"	25.40	129.50	210.5	56.0	DIN6535HB
H85524.0	–	32.00	135.20	220.2	60.0	DIN6535HE
H85531/32	1"	25.40	135.20	220.2	60.0	DIN6535HB
H85525.0	–	32.00	140.00	225.0	60.0	DIN6535HE
H8551.1/64	1.1/4	31.75	140.00	225.0	60.0	DIN6535HB
H85526.0	–	32.00	146.00	230.0	60.0	DIN6535HE
H8551.3/64	1.1/4	31.75	146.00	230.0	60.0	DIN6535HB
H85527.0	–	32.00	151.00	235.0	60.0	DIN6535HE
H8551.3/32	1.1/4	31.75	151.00	235.0	60.0	DIN6535HB



Product	DCON MS	DCON MS	LU	OAL	LS	ADINTMS
	(inch)	(mm)	(mm)	(mm)	(mm)	
H85528.0	–	32.00	157.00	240.0	60.0	DIN6535HE
H8551.1/8	1.1/4	31.75	157.00	240.0	60.0	DIN6535HB
H85529.0	–	32.00	162.00	245.0	60.0	DIN6535HE
H8551.11/64	1.1/4	31.75	162.00	245.0	60.0	DIN6535HB
H85530.0	–	32.00	167.00	255.0	60.0	DIN6535HE
H8551.3/16	1.1/4	31.75	167.00	255.0	60.0	DIN6535HB
H85532.0	–	32.00	176.50	261.5	60.0	DIN6535HE
H85533.5	–	32.00	186.50	271.5	60.0	DIN6535HE
H85535.0	–	40.00	196.50	291.5	70.0	DIN6535HB
H85536.5	–	40.00	201.50	296.5	70.0	DIN6535HB
H85538.0	–	40.00	211.50	306.5	70.0	DIN6535HB
H85539.5	–	40.00	221.50	316.5	70.0	DIN6535HB
H85541.0	–	40.00	226.50	325.6	70.0	DIN6535HB
H85542.5	–	40.00	236.50	336.5	70.0	DIN6535HB

H858



Cuerpo HYDRA 8XD, con Refrigeración Interna, Recubrimiento Niquelado Brillante

Se utiliza con cabezas HYDRA R950, R960 y R970. Se pueden utilizar varios diámetros de cabeza con el mismo cuerpo. Los agujeros de refrigerante alineados con las cabezas de corte ofrecen una refrigeración eficiente. La superficie brillante niquelada protege del óxido y la corrosión y mejora la evacuación de virutas.

HYDRA

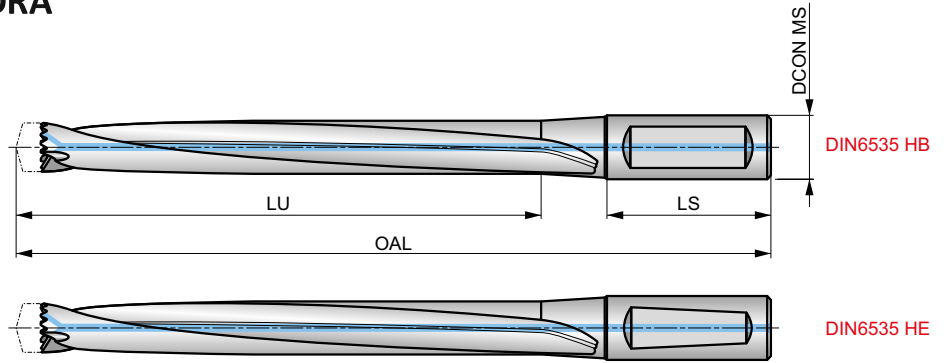

HSS		8xD
Bright Ni	DIN 6535HB DIN 6535HE	

Cuatro (4) tornillos y un (1) destornillador se incluyen en cada cuerpo de broca, DCON MS tolerancia h6.

Product	DCON MS (mm)	LU (mm)	OAL (mm)	LS (mm)	ADINTMS
H85814.0	16.00	124.50	191.5	48.0	DIN6535HE
H85815.0	20.00	133.50	201.5	50.0	DIN6535HE
H85816.0	20.00	141.50	211.5	50.0	DIN6535HE
H85817.0	20.00	150.50	221.5	50.0	DIN6535HE
H85818.0	20.00	158.50	226.5	50.0	DIN6535HE
H85819.0	25.00	167.50	251.5	56.0	DIN6535HE
H85820.0	25.00	175.50	264.5	56.0	DIN6535HE
H85821.0	25.00	184.50	266.5	56.0	DIN6535HE
H85822.0	25.00	192.10	271.1	56.0	DIN6535HE
H85823.0	25.00	200.50	280.5	56.0	DIN6535HE
H85824.0	32.00	208.20	295.2	60.0	DIN6535HE
H85825.0	32.00	217.00	300.0	60.0	DIN6535HE
H85826.0	32.00	225.00	310.0	60.0	DIN6535HE
H85827.0	32.00	234.00	320.0	60.0	DIN6535HE
H85828.0	32.00	242.00	325.0	60.0	DIN6535HE
H85829.0	32.00	251.00	335.0	60.0	DIN6535HE
H85830.0	32.00	259.00	345.0	60.0	DIN6535HE
H85832.0	32.00	271.50	356.5	60.0	DIN6535HE
H85833.5	32.00	286.50	371.5	60.0	DIN6535HE
H85835.0	40.00	301.50	396.5	70.0	DIN6535HB
H85836.5	40.00	311.50	406.5	70.0	DIN6535HB
H85838.0	40.00	326.50	421.5	70.0	DIN6535HB
H85839.5	40.00	336.50	431.5	70.0	DIN6535HB
H85841.0	40.00	351.50	451.5	70.0	DIN6535HB
H85842.5	40.00	361.50	461.5	70.0	DIN6535HB

H8512



Cuerpo HYDRA 12XD, con Refrigeración Interna, Recubrimiento Niquelado Brillante

Se utiliza con cabezas HYDRA R950, R960 y R970. Se pueden utilizar varios diámetros de cabeza con el mismo cuerpo. Los agujeros de refrigerante alineados con las cabezas de corte ofrecen una refrigeración eficiente. El mango con brida evita que la broca se mueva en el soporte. La superficie brillante niquelada protege del óxido y la corrosión y mejora la evacuación de virutas.

HYDRA

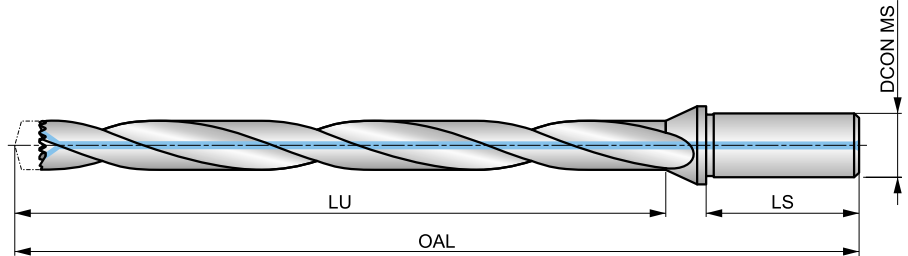

HSS	DORMER	12xD
Bright Ni		

Cuatro (4) tornillos y un (1) destornillador se incluyen en cada cuerpo de broca, DCON MS tolerancia h6.

Product	DCON MS (mm)	LU (mm)	OAL (mm)	LS (mm)
H851214.0	16.00	168.00	236.0	48.0
H851215.0	20.00	180.00	250.3	50.0
H851216.0	20.00	192.00	262.6	50.0
H851217.0	20.00	204.00	275.0	50.0
H851218.0	20.00	216.00	287.2	50.0
H851219.0	25.00	228.00	305.6	56.0
H851220.0	25.00	240.00	317.8	56.0
H851221.0	25.00	252.00	330.1	56.0
H851222.0	25.00	264.00	343.0	56.0
H851223.0	25.00	276.00	354.8	56.0
H851224.0	32.00	288.00	371.7	60.0
H851225.0	32.00	300.00	383.8	60.0

R950

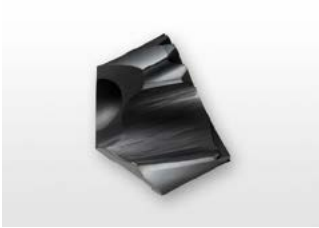

Cabeza HYDRA de Metal Duro Para Acero, con Recubrimiento Ti-phon

Cabeza intercambiable de precisión y altamente rentable para ofrecer un alto rendimiento en aceros y materiales mas duros. La punta dividida de 140° favorece el auto-centrado y reduce las fuerzas de corte. El recubrimiento Ti-phon evita el filo de aportación y mejora en gran medida el flujo de viruta, con una resistencia superior al desgaste y gran resistencia del filo.

HYDRA

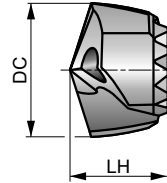

HM	DORMER	140°
Ti-phon	R	DC
DC h7		

H851	Aplicar valores de partida para la velocidad y el avance con un factor de corrección de 1.10
H853	Aplicar valores de partida para la velocidad y el avance con un factor de corrección de 1.00
H855	Aplicar valores de partida para la velocidad y el avance con un factor de corrección de 0.80
H858	Aplicar valores de partida para la velocidad y el avance con un factor de corrección de 0.60
H8512	Aplicar valores de partida para la velocidad y el avance con un factor de corrección de 0.50

Grupo de Material de la pieza adecuado y condiciones de velocidad de corte iniciales (m/min) y código de avance alfabético. Tablas con avance por revolución a partir de la pag.274.

P1.1	P1.2	P1.3	P2.1	P2.2	P2.3	P3.1	P3.2	P3.3	P4.1	P4.2	P4.3	M2.3	M4.2
133 W	148 W	154 W	114 W	100 W	88 W	125 W	101 W	85 W	75 W	63 W	52 T	41 T	35 T
K2.1	K2.2	K2.3	K3.1	K3.2	K3.3	K4.1	K4.2	K4.3	K4.4	K4.5	K5.1	K5.2	K5.3
108 V	88 V	70 V	96 V	73 V	59 V	89 V	67 V	49 V	42 V	35 V	100 V	76 V	58 V

Product	DC	DC	DC	LH
	(inch)	(mm)	(inch)	(mm)
R95015/32	15/32	11.91	0.4688	9.1
R95012.0	—	12.00	0.4724	9.1
R95012.1	—	12.10	0.4764	9.1
R95012.2	—	12.20	0.4803	9.1
R95031/64	31/64	12.30	0.4844	9.1
R95012.5	—	12.50	0.4921	9.4
R95012.6	—	12.60	0.4961	9.4
R9501/2	1/2	12.70	0.5000	9.4
R95012.8	—	12.80	0.5039	9.4
R95012.9	—	12.90	0.5079	9.4
R95013.0	—	13.00	0.5118	9.7
R95033/64	33/64	13.10	0.5156	9.7
R95013.2	—	13.20	0.5197	9.7
R95017/32	17/32	13.49	0.5313	9.7
R95013.5	—	13.50	0.5315	10.3
R95013.6	—	13.60	0.5354	10.3
R95013.7	—	13.70	0.5394	10.3
R95013.8	—	13.80	0.5433	10.3
R95035/64	35/64	13.89	0.5469	10.3
R95014.0	—	14.00	0.5512	10.3
R95014.1	—	14.10	0.5551	10.3
R95014.2	—	14.20	0.5591	10.3
R9509/16	9/16	14.29	0.5625	10.3
R95014.5	—	14.50	0.5709	10.3
R95014.6	—	14.60	0.5748	11.0
R95037/64	37/64	14.68	0.5781	11.0
R95014.7	—	14.70	0.5787	11.0
R95014.8	—	14.80	0.5827	11.0
R95015.0	—	15.00	0.5906	11.0
R95019/32	19/32	15.08	0.5938	11.0

Product	DC	DC	DC	LH
	(inch)	(mm)	(inch)	(mm)
R95015.1	—	15.10	0.5945	11.0
R95015.2	—	15.20	0.5984	11.0
R95015.24	—	15.24	0.6000	11.0
R95039/64	39/64	15.48	0.6094	11.0
R95015.5	—	15.50	0.6102	11.0
R95015.6	—	15.60	0.6142	11.6
R95015.7	—	15.70	0.6181	11.6
R9505/8	5/8	15.88	0.6250	11.6
R95016.0	—	16.00	0.6299	11.6
R95016.08	—	16.08	0.6331	11.6
R95016.1	—	16.10	0.6339	11.6
R95016.2	—	16.20	0.6378	11.6
R95041/64	41/64	16.27	0.6406	11.6
R95016.3	—	16.30	0.6417	11.6
R95016.5	—	16.50	0.6496	11.6
R95016.6	—	16.60	0.6535	12.2
R95021/32	21/32	16.67	0.6563	12.2
R95016.7	—	16.70	0.6575	12.2
R95017.0	—	17.00	0.6693	12.2
R95043/64	43/64	17.07	0.6719	12.2
R95017.1	—	17.10	0.6732	12.2
R95017.2	—	17.20	0.6772	12.2
R95011/16	11/16	17.46	0.6875	12.2
R95017.5	—	17.50	0.6890	12.2
R95017.6	—	17.60	0.6929	12.9
R95017.7	—	17.70	0.6969	12.9
R95045/64	45/64	17.86	0.7031	12.9
R95018.0	—	18.00	0.7087	12.9
R95018.1	—	18.10	0.7126	12.9
R95018.2	—	18.20	0.7165	12.9

Product	DC	DC	DC	LH
	(inch)	(mm)	(inch)	(mm)
R95023/32	23/32	18.26	0.7188	12.9
R95018.5	–	18.50	0.7283	12.9
R95018.6	–	18.60	0.7323	13.5
R95047/64	47/64	18.65	0.7344	13.5
R95018.7	–	18.70	0.7362	13.5
R95018.9	–	18.90	0.7441	13.5
R95019.0	–	19.00	0.7480	13.5
R9503/4	3/4	19.05	0.7500	13.5
R95019.1	–	19.10	0.7520	13.5
R95019.2	–	19.20	0.7559	13.5
R95019.25	–	19.25	0.7579	13.5
R95019.3	–	19.30	0.7598	13.5
R95019.35	–	19.35	0.7618	13.5
R95049/64	49/64	19.45	0.7656	13.5
R95019.5	–	19.50	0.7677	13.5
R95019.6	–	19.60	0.7717	14.1
R95019.7	–	19.70	0.7756	14.1
R95025/32	25/32	19.84	0.7813	14.1
R95020.0	–	20.00	0.7874	14.1
R95051/64	51/64	20.24	0.7969	14.1
R95020.5	–	20.50	0.8071	14.1
R95013/16	13/16	20.64	0.8125	14.8
R95021.0	–	21.00	0.8268	14.8
R95053/64	53/64	21.03	0.8281	14.8
R95027/32	27/32	21.43	0.8438	14.8
R95021.5	–	21.50	0.8465	14.8
R95055/64	55/64	21.83	0.8594	15.0
R95022.0	–	22.00	0.8661	15.0
R9507/8	7/8	22.22	0.8750	15.0
R95022.5	–	22.50	0.8858	15.0
R95057/64	57/64	22.62	0.8906	15.0
R95022.7	–	22.70	0.8937	15.0
R95023.0	–	23.00	0.9055	15.1
R95029/32	29/32	23.02	0.9063	15.1
R95059/64	59/64	23.42	0.9219	15.1
R95023.5	–	23.50	0.9252	15.1
R95015/16	15/16	23.81	0.9375	15.4
R95024.0	–	24.00	0.9449	15.4
R95061/64	61/64	24.21	0.9531	15.4
R95024.5	–	24.50	0.9646	15.4
R95031/32	31/32	24.61	0.9688	15.4
R95025.0	–	25.00	0.9844	15.8
R95063/64	63/64	25.00	0.9844	15.8
R9501	1"	25.40	1.0000	15.8
R95025.5	–	25.50	1.0039	15.8
R95025.6	–	25.60	1.0079	15.8
R95025.65	–	25.65	1.0098	15.8
R9501.1/64	1.1/64	25.80	1.0156	15.8
R95026.0	–	26.00	1.0236	16.4
R9501.1/32	1.1/32	26.19	1.0313	16.4

Product	DC	DC	DC	LH
	(inch)	(mm)	(inch)	(mm)
R95026.5	–	26.50	1.0433	16.4
R9501.3/64	1.3/64	26.59	1.0469	16.4
R9501.1/16	1.1/16	26.99	1.0625	17.1
R95027.0	–	27.00	1.0630	17.1
R9501.5/64	1.5/64	27.38	1.0781	17.1
R95027.5	–	27.50	1.0827	17.1
R9501.3/32	1.3/32	27.78	1.0938	17.1
R95028.0	–	28.00	1.1024	17.7
R9501.7/64	1.7/64	28.18	1.1094	17.7
R95028.5	–	28.50	1.1220	17.7
R9501.1/8	1.1/8	28.58	1.1250	17.7
R9501.9/64	1.9/64	28.97	1.1406	18.3
R95029.0	–	29.00	1.1417	18.3
R9501.5/32	1.5/32	29.37	1.1563	18.3
R95029.5	–	29.50	1.1614	18.3
R9501.11/64	1.11/64	29.77	1.1719	18.3
R95030.0	–	30.00	1.1811	19.0
R9501.3/16	1.3/16	30.16	1.1875	19.0
R95030.5	–	30.50	1.2008	19.0
R9501.7/32	1.7/32	30.96	1.2188	21.0
R95031.0	–	31.00	1.2205	21.0
R9501.1/4	1.1/4	31.75	1.2500	21.0
R95032.0	–	32.00	1.2598	21.0
R95032.5	–	32.50	1.2795	21.0
R9501.19/64	1.19/64	32.94	1.2969	21.0
R95033.0	–	33.00	1.2992	21.0
R95033.5	–	33.50	1.3189	21.0
R95034.0	–	34.00	1.3386	23.0
R9501.11/32	1.11/32	34.13	1.3438	23.0
R95034.5	–	34.50	1.3583	23.0
R9501.3/8	1.3/8	34.93	1.3750	23.0
R95035.0	–	35.00	1.3780	23.0
R95036.0	–	36.00	1.4173	23.0
R9501.27/64	1.27/64	36.12	1.4219	23.0
R95036.5	–	36.50	1.4370	23.0
R95037.0	–	37.00	1.4567	25.0
R9501.15/32	1.15/32	37.31	1.4688	25.0
R95037.5	–	37.50	1.4764	25.0
R95038.0	–	38.00	1.4961	25.0
R9501.1/2	1.1/2	38.10	1.5000	25.0
R95038.5	–	38.50	1.5157	25.0
R9501.17/32	1.17/32	38.89	1.5313	25.0
R95039.0	–	39.00	1.5354	25.0
R95039.5	–	39.50	1.5551	25.0
R9501.9/16	1.9/16	39.69	1.5625	27.0
R95040.0	–	40.00	1.5748	27.0
R95041.0	–	41.00	1.6142	27.0
R9501.5/8	1.5/8	41.28	1.6250	27.0
R95042.0	–	42.00	1.6535	27.0

R960

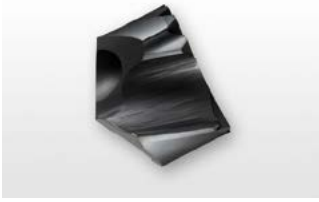

Cabeza HYDRA de Metal Duro Para Acero Inoxidable, con Recubrimiento Ti-phon

Cabeza intercambiable de precisión y altamente rentable para ofrecer un alto rendimiento en acero inoxidable. La punta dividida de 140° favorece el autocentrado y reduce las fuerzas de corte. El recubrimiento Ti-phon evita el filo de aportación y mejora en gran medida el flujo de viruta, con una resistencia superior al desgaste y gran resistencia del filo.

HYDRA

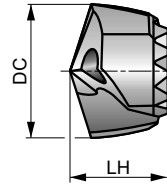

HM	DORMER	140°
Ti-phon	R	DC
DC h7		

H851	Aplicar valores de partida para la velocidad y el avance con un factor de corrección de 1.10
H853	Aplicar valores de partida para la velocidad y el avance con un factor de corrección de 1.00
H855	Aplicar valores de partida para la velocidad y el avance con un factor de corrección de 0.80
H858	Aplicar valores de partida para la velocidad y el avance con un factor de corrección de 0.60
H8512	Aplicar valores de partida para la velocidad y el avance con un factor de corrección de 0.50

Grupo de Material de la pieza adecuado y condiciones de velocidad de corte iniciales (m/min) y código de avance alfabético. Tablas con avance por revolución a partir de la pag.274.

P1.1	P1.2	P1.3	P2.1	M1.1	M1.2	M2.1	M2.2	M2.3	M3.1	M3.2	M3.3	M4.1	M4.2
■ 133 W	■ 148 W	■ 154 W	■ 114 W	■ 82 V	■ 70 V	■ 73 V	■ 60 V	▣ 50 T	■ 58 T	■ 50 T	■ 45 T	■ 40 T	▣ 34 T
K1.1	K1.2	K1.3	K2.1	K2.2	K2.3	K3.1	K3.2	K3.3	K4.1	K4.2	K4.3	K4.4	K4.5
■ 120 V	■ 89 V	■ 67 V	▣ 108 V	▣ 88 V	▣ 70 V	▣ 96 V	▣ 73 V	▣ 59 V	▣ 89 V	▣ 67 V	▣ 49 V	▣ 42 V	▣ 35 V
K5.1	K5.2	K5.3	S1.1	S1.2	S1.3	S2.1	S2.2	S3.1	S3.2	S4.1	S4.2		
▣ 100 V	▣ 76 V	▣ 58 V	▣ 45 T	▣ 35 T	▣ 30 S	▣ 40 S	▣ 35 S	▣ 30 S	▣ 25 S	▣ 23 S	▣ 20 S		

Product	DC (inch)	DC (mm)	DC (inch)	LH (mm)
R96015/32	15/32	11.91	0.4688	9.1
R96012.0	–	12.00	0.4724	9.1
R96012.1	–	12.10	0.4764	9.1
R96012.2	–	12.20	0.4803	9.1
R96031/64	31/64	12.30	0.4844	9.1
R96012.5	–	12.50	0.4921	9.4
R96012.6	–	12.60	0.4961	9.4
R9601/2	1/2	12.70	0.5000	9.4
R96012.8	–	12.80	0.5039	9.4
R96012.9	–	12.90	0.5079	9.4
R96013.0	–	13.00	0.5118	9.7
R96033/64	33/64	13.10	0.5156	9.7
R96013.2	–	13.20	0.5197	9.7
R96017/32	17/32	13.49	0.5313	9.7
R96013.5	–	13.50	0.5315	10.3
R96013.6	–	13.60	0.5354	10.3
R96013.7	–	13.70	0.5394	10.3
R96013.8	–	13.80	0.5433	10.3
R96035/64	35/64	13.89	0.5469	10.3
R96014.0	–	14.00	0.5512	10.3
R96014.1	–	14.10	0.5551	10.3
R96014.2	–	14.20	0.5591	10.3
R9609/16	9/16	14.29	0.5625	10.3
R96014.5	–	14.50	0.5709	10.3
R96014.6	–	14.60	0.5748	11.0
R96037/64	37/64	14.68	0.5781	11.0
R96014.7	–	14.70	0.5787	11.0
R96014.8	–	14.80	0.5827	11.0

Product	DC (inch)	DC (mm)	DC (inch)	LH (mm)
R96015.0	–	15.00	0.5906	11.0
R96019/32	19/32	15.08	0.5938	11.0
R96015.1	–	15.10	0.5945	11.0
R96015.2	–	15.20	0.5984	11.0
R96015.24	–	15.24	0.6000	11.0
R96039/64	39/64	15.48	0.6094	11.0
R96015.5	–	15.50	0.6102	11.0
R96015.6	–	15.60	0.6142	11.6
R96015.7	–	15.70	0.6181	11.6
R9605/8	5/8	15.88	0.6250	11.6
R96016.0	–	16.00	0.6299	11.6
R96016.08	–	16.08	0.6331	11.6
R96016.1	–	16.10	0.6339	11.6
R96016.2	–	16.20	0.6378	11.6
R96041/64	41/64	16.27	0.6406	11.6
R96016.3	–	16.30	0.6417	11.6
R96016.5	–	16.50	0.6496	11.6
R96016.6	–	16.60	0.6535	12.2
R96021/32	21/32	16.67	0.6563	12.2
R96016.7	–	16.70	0.6575	12.2
R96017.0	–	17.00	0.6693	12.2
R96043/64	43/64	17.07	0.6719	12.2
R96017.1	–	17.10	0.6732	12.2
R96017.2	–	17.20	0.6772	12.2
R96011/16	11/16	17.46	0.6875	12.2
R96017.5	–	17.50	0.6890	12.2
R96017.6	–	17.60	0.6929	12.9
R96017.7	–	17.70	0.6969	12.9



Product	DC	DC	DC	LH
	(inch)	(mm)	(inch)	(mm)
R96045/64	45/64	17.86	0.7031	12.9
R96018.0	–	18.00	0.7087	12.9
R96018.1	–	18.10	0.7126	12.9
R96018.2	–	18.20	0.7165	12.9
R96023/32	23/32	18.26	0.7188	12.9
R96018.5	–	18.50	0.7283	12.9
R96018.6	–	18.60	0.7323	13.5
R96047/64	47/64	18.65	0.7344	13.5
R96018.7	–	18.70	0.7362	13.5
R96018.9	–	18.90	0.7441	13.5
R96019.0	–	19.00	0.7480	13.5
R9603/4	3/4	19.05	0.7500	13.5
R96019.1	–	19.10	0.7520	13.5
R96019.2	–	19.20	0.7559	13.5
R96019.25	–	19.25	0.7579	13.5
R96019.3	–	19.30	0.7598	13.5
R96019.35	–	19.35	0.7618	13.5
R96049/64	49/64	19.45	0.7656	13.5
R96019.5	–	19.50	0.7677	13.5
R96019.6	–	19.60	0.7717	14.1
R96019.7	–	19.70	0.7756	14.1
R96025/32	25/32	19.84	0.7813	14.1
R96020.0	–	20.00	0.7874	14.1
R96051/64	51/64	20.24	0.7969	14.1
R96020.5	–	20.50	0.8071	14.1
R96013/16	13/16	20.64	0.8125	14.8
R96021.0	–	21.00	0.8268	14.8
R96053/64	53/64	21.03	0.8281	14.8
R96027/32	27/32	21.43	0.8438	14.8
R96021.5	–	21.50	0.8465	14.8
R96055/64	55/64	21.83	0.8594	15.0
R96022.0	–	22.00	0.8661	15.0
R9607/8	7/8	22.22	0.8750	15.0
R96022.5	–	22.50	0.8858	15.0
R96057/64	57/64	22.62	0.8906	15.0
R96022.7	–	22.70	0.8937	15.0

Product	DC	DC	DC	LH
	(inch)	(mm)	(inch)	(mm)
R96023.0	–	23.00	0.9055	15.1
R96029/32	29/32	23.02	0.9063	15.1
R96059/64	59/64	23.42	0.9219	15.1
R96023.5	–	23.50	0.9252	15.1
R96015/16	15/16	23.81	0.9375	15.4
R96024.0	–	24.00	0.9449	15.4
R96061/64	61/64	24.21	0.9531	15.4
R96024.5	–	24.50	0.9646	15.4
R96031/32	31/32	24.61	0.9688	15.4
R96025.0	–	25.00	0.9844	15.8
R96063/64	63/64	25.00	0.9844	15.8
R9601	1"	25.40	1.0000	15.8
R96025.5	–	25.50	1.0039	15.8
R96025.65	–	25.65	1.0098	15.8
R9601.1/64	1.1/64	25.80	1.0156	15.8
R96026.0	–	26.00	1.0236	16.4
R9601.1/32	1.1/32	26.19	1.0313	16.4
R96026.5	–	26.50	1.0433	16.4
R9601.3/64	1.3/64	26.59	1.0469	16.4
R9601.1/16	1.1/16	26.99	1.0625	17.1
R96027.0	–	27.00	1.0630	17.1
R9601.5/64	1.5/64	27.38	1.0781	17.1
R96027.5	–	27.50	1.0827	17.1
R9601.3/32	1.3/32	27.78	1.0938	17.1
R96028.0	–	28.00	1.1024	17.7
R9601.7/64	1.7/64	28.18	1.1094	17.7
R96028.5	–	28.50	1.1220	17.7
R9601.1/8	1.1/8	28.58	1.1250	17.7
R9601.9/64	1.9/64	28.97	1.1406	18.3
R96029.0	–	29.00	1.1417	18.3
R9601.5/32	1.5/32	29.37	1.1563	18.3
R96029.5	–	29.50	1.1614	18.3
R9601.11/64	1.11/64	29.77	1.1719	18.3
R96030.0	–	30.00	1.1811	19.0
R9601.3/16	1.3/16	30.16	1.1875	19.0
R96030.5	–	30.50	1.2008	19.0



H860

DORMER

Tornillos para HYDRA

Tornillos de repuesto para sujetar firmemente las cabezas HYDRA en su lugar.



HYDRA

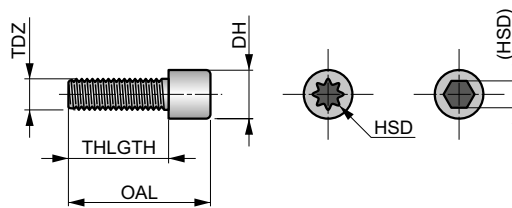

Product	Nr.	TDZ	OAL	THLGTH	DH	HSD
			(mm)	(mm)	(mm)	
H860N1	1	M2.2	7.5	5.70	3.5	8IP
H860N2	2	M2.5	9.0	7.00	4.1	10IP
H860N3	3	M3.0	10.5	8.00	4.9	15IP
H860N4	4	M3.5	11.5	8.80	5.5	15IP
H860N5	5	M4.0	12.5	9.50	6.0	20IP
H860N6	6	M4.5	14.3	10.80	6.8	25IP
H860N7	7	M5.0	20.0	15.00	8.5	4

H861

DORMER

Destornillador para HYDRA

Destornilladores para apretar los tornillos HYDRA.





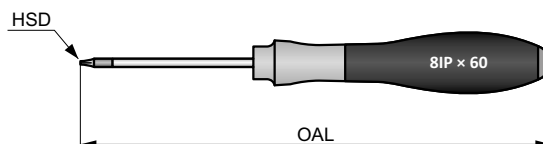





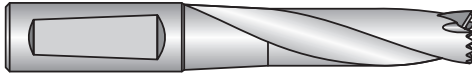



HYDRA



Product	Nr.	HSD	OAL
			(mm)
H861N1	N1	8IP	164.0
H861N2	N2	10IP	191.0
H861N3	N3	15IP	191.0
H861N4	N4	20IP	218.0
H861N5	N5	25IP	218.0

BROCAS DE ALTO RENDIMIENTO CON CABEZA INTERCAMBIABLE

Configuración									
DC	H851 1.5×D	H853 3×D	H855 5×D	H858 8×D	H8512 12×D	R950	R960	H860	H861
Rango	12.00 – 30.50 15/32" – 1.3/16"	12.00 – 42.50 15/32" – 1.5/8"	12.00 – 42.50 15/32" – 1.5/8"	13.50 – 42.50 35/64" – 1.5/8"	13.50 – 25.65 35/64" – 1.1/64"	12.00 – 42.00 15/32" – 1.5/8"	12.00 – 30.50 15/32" – 1.3/16"	N1 – N7	N1 – N6
Páginas	 218	 219	 221	 223	 224	 225	 227	 229	 229

DC	H851 1.5×D	H853 3×D	H855 5×D	H858 8×D	H8512 12×D	R950	R960	H860	H861
15/32"						R95015/32	R96015/32		
12.0						R95012.0	R96012.0		
12.1	H85112.0	H85312.0	H85512.0	-	-	R95012.1	R96012.1		
12.2	H85131/64	H85331/64	H85531/64			R95012.2	R96012.2		
31/64"						R95031/64	R96031/64		
12.5						R95012.5	R96012.5		
12.6						R95012.6	R96012.6		
1/2"	H85112.5	H85312.5	H85512.5	-	-	R9501/2	R9601/2		
12.8						R95012.8	R96012.8		
12.9						R95012.9	R96012.9		
13.0						R95013.0	R96013.0		
33/64"	H85113.0	H85313.0	H85513.0	-	-	R95033/64	R96033/64		
13.2	H85117/32	H85317/32	H85517/32			R95013.2	R96013.2		
17/32"						R95017/32	R96017/32		
13.5						R95013.5	R96013.5		
13.6						R95013.6	R96013.6		
13.7						R95013.7	R96013.7		
13.8						R95013.8	R96013.8	H860N1	H861N1
35/64"	H85114.0	H85314.0	H85514.0	H85814.0	H851214.0	R95035/64	R96035/64		
14.0		H85339/16	H85539/16			R95014.0	R96014.0		
14.1						R95014.1	R96014.1		
14.2						R95014.2	R96014.2		
9/16"						R9509/16	R9609/16		
14.5						R95014.5	R96014.5		
14.6						R95014.6	R96014.6		
37/64"						R95037/64	R96037/64		
14.7						R95014.7	R96014.7		
14.8						R95014.8	R96014.8		
15.0						R95015.0	R96015.0		
19/32"	H85115.0	H85315.0	H85515.0	H85815.0	H851215.0	R95019/32	R96019/32		
15.1	H85139/64	H85339/64	H85539/64			R95015.1	R96015.1		
15.2						R95015.2	R96015.2		
15.24						R95015.24	R96015.24		
39/64"						R95039/64	R96039/64		
15.5						R95015.5	R96015.5		

**BROCAS DE ALTO RENDIMIENTO CON CABEZA INTERCAMBIABLE**

DC	H851 1.5xD	H853 3xD	H855 5xD	H858 8xD	H8512 12xD	R950	R960	H860	H861
15.6						R95015.6	R96015.6	H860N2	H861N2
15.7						R95015.7	R96015.7		
5/8"						R9505/8	R9605/8		
16.0						R95016.0	R96016.0		
16.08	H85116.0	H85316.0	H85516.0	H85816.0	H851216.0	R95016.08	R96016.08		
16.1	H85141/64	H85341/64	H85541/64			R95016.1	R96016.1		
16.2						R95016.2	R96016.2		
16.3						R95016.3	R96016.3		
41/64"						R95041/64	R96041/64		
16.5						R95016.5	R96016.5		
16.6						R95016.6	R96016.6		
21/32"						R95021/32	R96021/32		
16.7						R95016.7	R96016.7		
17.0	H85117.0	H85317.0	H85517.0	H85817.0	H851217.0	R95017.0	R96017.0		
43/64"	H85111/16	H85311/16	H85511/16			R95043/64	R96043/64		
17.1						R95017.1	R96017.1		
17.2						R95017.2	R96017.2		
11/16"						R95011/16	R96011/16		
17.5						R95017.5	R96017.5		
17.6						R95017.6	R96017.6		
17.7						R95017.7	R96017.7		
45/64"						R95045/64	R96045/64		
18.0	H85118.0	H85318.0	H85518.0	H85818.0	H851218.0	R95018.0	R96018.0		
18.1	H85123/32	H85323/32	H85523/32			R95018.1	R96018.1		
18.2						R95018.2	R96018.2		
23/32"						R95023/32	R96023/32		
18.5						R95018.5	R96018.5		
18.6						R95018.6	R96018.6		
47/64"						R95047/64	R96047/64		
18.7						R95018.7	R96018.7		
18.9						R95018.9	R96018.9		
19.0						R95019.0	R96019.0		
3/4"						R9503/4	R9603/4		
19.1	H85119.0	H85319.0	H85519.0	H85819.0	H851219.0	R95019.1	R96019.1		
19.2	H85149/64	H85349/64	H85549/64			R95019.2	R96019.2		
19.25						R95019.25	R96019.25		
19.3						R95019.3	R96019.3		
19.35						R95019.35	R96019.35		
49/64"						R95049/64	R96049/64		
19.5						R95019.5	R96019.5		
19.6						R95019.6	R96019.6		
19.7						R95019.7	R96019.7		
25/32"	H85120.0	H85320.0	H85520.0	H85820.0	H851220.0	R95025/32	R96025/32		
20.0	H85151/64	H85351/64	H85551/64			R95020.0	R96020.0		
51/64"						R95051/64	R96051/64		
20.5						R95020.5	R96020.5		
13/16"						R95013/16	R96013/16		
21.0	H85121.0	H85321.0	H85521.0	H85821.0	H851221.0	R95021.0	R96021.0		
53/64"	H85127/32	H85327/32	H85527/32			R95053/64	R96053/64		
27/32"						R95027/32	R96027/32		
21.5						R95021.5	R96021.5		
55/64"						R95055/64	R96055/64		
22.0						R95022.0	R96022.0		
7/8"	H85122.0	H85322.0	H85522.0	H85822.0	H851222.0	R9507/8	R9607/8		
22.5	H85157/64	H85357/64	H85557/64			R95022.5	R96022.5		
57/64"						R95057/64	R96057/64		
22.7						R95022.7	R96022.7		
23.0						R95023.0	R96023.0		
29/32"	H85123.0	H85323.0	H85523.0	H85823.0	H851223.0	R95029/32	R96029/32		
59/64"	H85159/64	H85359/64	H85559/64			R95059/64	R96059/64		
23.5						R95023.5	R96023.5		

BROCAS DE ALTO RENDIMIENTO CON CABEZA INTERCAMBIABLE

DC	H851 1.5xD	H853 3xD	H855 5xD	H858 8xD	H8512 12xD	R950	R960	H860	H861
15/16	H85124.0 H85131/32	H85324.0 H85331/32	H85524.0 H85531/32	H85824.0	H851224.0	R95015/16	R96015/16	H860N4	H861N3
24.0						R95024.0	R96024.0		
61/64						R95061/64	R96061/64		
24.5						R95024.5	R96024.5		
31/32"						R95031/32	R96031/32		
25.0	H85125.0 H8511.1/64	H85325.0 H8531.1/64	H85525.0 H8551.1/64	H85825.0	H851225.0	R95025.0	R96025.0	H860N5	H861N4
63/64"						R95063/64	R96063/64		
1"						R9501	R9601		
25.5						R95025.5	R96025.5		
25.6						R95025.6	–		
25.65						R95025.65	R96025.65		
1.1/64"						R9501.1/64	R9601.1/64		
26.0	H85126.0 H8511.3/64	H85326.0 H8531.3/64	H85526.0 H8551.3/64	H85826.0	–	R95026.0	R96026.0	H860N6	H861N5
1.1/32"						R9501.1/32	R9601.1/32		
26.5						R95026.5	R96026.5		
1.3/64						R9501.3/64	R9601.3/64		
1.1/16"	H85127.0 H8511.3/32	H85327.0 H8531.3/32	H85527.0 H8551.3/32	H85827.0	–	R9501.1/16	R9601.1/16	H860N7	H861N6
27.0						R95027.0	R96027.0		
1.5/64"						R9501.5/64	R9601.5/64		
27.5						R95027.5	R96027.5		
1.3/32"						R9501.3/32	R9601.3/32		
28.0	H85128.0	H85328.0 H8531.1/8	H85528.0 H8551.1/8	H85828.0	–	R95028.0	R96028.0	H860N8	H861N7
1.7/64"						R9501.7/64	R9601.7/64		
28.5						R95028.5	R96028.5		
1.1/8"						R9501.1/8	R9601.1/8		
1.9/64"	H85129.0	H85329.0 H8531.11/64	H85529.0 H8551.11/64	H85829.0	–	R9501.9/64	R9601.9/64	H860N9	H861N8
29.0						R95029.0	R96029.0		
1.5/32"						R9501.5/32	R9601.5/32		
29.5						R95029.5	R96029.5		
1.11/64"						R9501.11/64	R9601.11/64		
30.0	H85130.0 H8511.3/16	H85330.0 H8531.3/16	H85530.0 H8551.3/16	H85830.0	–	R95030.0	R96030.0	H860N10	H861N9
1.3/16"						R9501.3/16	R9601.3/16		
30.5	–	H85332.0	H85532.0	H85832.0	–	R95030.5	R96030.5	H860N11	H861N10
1.7/32"						R9501.7/32	–		
31.0						R95031.0	–		
1.1/4"						R9501.1/4	–		
32.0	–	H85333.5	H85533.5	H85833.5	–	R95032.0	–	H860N12	H861N11
32.5						R95032.5	–		
1.19/64"						R9501.19/64	–		
33.0						R95033.0	–		
33.5						R95033.5	–		
34.0	–	H85335.0	H85535.0	H85835.0	–	R95034.0	–	H860N13	H861N12
1.11/32"						R9501.11/32	–		
34.5						R95034.5	–		
1.3/8"						R9501.3/8	–		
35.0	–	H85336.5	H85536.5	H85836.5	–	R95035.0	–	H860N14	H861N13
36.0						R95036.0	–		
1.27/64"						R9501.27/64	–		
36.5	–	H85338.0	H85538.0	H85838.0	–	R95036.5	–	H860N15	H861N14
37.0						R95037.0	–		
1.15/32"						R9501.15/32	–		
37.5						R95037.5	–		
38.0	–	H85339.5	H85539.5	H85839.5	–	R95038.0	–	H860N16	H861N15
1.1/2"						R9501.1/2	–		
38.5						R95038.5	–		
1.17/32"						R9501.17/32	–		
39.0						R95039.0	–		
39.5	R95039.5	–							
1.9/16"	–	H85341.0	H85541.0	H85841.0	–	R9501.9/16	–	H860N17	H861N16
40.0						R95040.0	–		
41.0	–	–	–	–	–	R95041.0	–	–	–

BROCAS DE ALTO RENDIMIENTO CON CABEZA INTERCAMBIABLE

DC	H851 1.5×D	H853 3×D	H855 5×D	H858 8×D	H8512 12×D	R950	R960	H860	H861
1.5/8"	–	H85342.5	H85542.5	H85842.5	–	R9501.5/8	–	H860N7	–
42.0						R95042.0	–		

Accesorios

H860	H861	Cabeza Hydra DC			Tamaño de la llave/broca
		Métrica (mín.-máx.)	Fracional (mín.-máx.)	Decimal (mín.-máx.)	
H860N1	H861N1	12.0 mm – 15.5 mm	15/32" – 39/64"	0.4688" – 0.6102"	8IP
H860N2	H861N2	15.6 mm – 18.5 mm	5/8" – 23/32"	0.6142" – 0.7283"	10IP
H860N3	H861N3	18.6 mm – 21.5 mm	47/64" – 27/32"	0.7323" – 0.8465"	15IP
H860N4	H861N3	22.0 mm – 24.5 mm	55/64" – 31/32"	0.8594" – 0.9688"	15IP
H860N5	H861N4	25.0 mm – 27.5 mm	63/64" – 1-3/32"	0.9843" – 1.0938"	20IP
H860N6	H861N5	28.0 mm – 33.5 mm	1-7/64" – 1-19/64"	1.1024" – 1.3189"	25IP
H860N7	–	34.0 mm – 42.0 mm	1-11/32" – 1-5/8"	1.3386" – 1.6535"	4 mm Hex

Código de Material (BMC)	HSS	HSS	HSS	HSS								
Longitud Útil (ULDR)	2×D	3×D	4×D	5×D								
Recubrimiento	Bright Ni	Bright Ni	Bright Ni	Bright Ni								
Mango	ISO 9766	ISO 9766	ISO 9766	ISO 9766								
Mano (dirección de corte)	R	R	R	R								
Refrigeración (CSP)												
Tolerancia de la broca	± 0.05	± 0.05	± 0.05	± 0.05								
Tolerancia del agujero *	0/+0.2	0/+0.3	0/+0.4	0/+0.5								
Acabado superficial *	2–6 µm	2–6 µm	2–6 µm	2–6 µm								
Código de Familia de Producto	802D	803D	804D	805D	XPET..AP	SCET..-UD	XPET..AP-SD	SCET..-SD	EP			
	15.0–40.0	15.0–58.0	17.0–58.0	19.0–31.0								
	236	238	241	243	246	245	246	245	247			
P	P1				■	■	■	■				
	P2				■	■	■	■				
	P3				■	■	■	■				
	P4				■	■	■	■				
M	M1						■	■				
	M2						■	■				
	M3						■	■				
	M4						■	■				
K	K1				▣	■	▣	▣				
	K2				▣	■	▣	▣				
	K3				▣	■	▣	▣				
	K4				▣	■	▣	▣				
	K5				▣	■	▣	▣				
N	N1											
	N2											
	N3											
	N4											
	N5											
S	S1						▣	▣				
	S2						▣	▣				
	S3						▣	▣				
	S4						▣	▣				
H	H1											
	H2											

* La tolerancia del agujero y el acabado superficial dependen en gran medida de las condiciones de mecanizado

802D

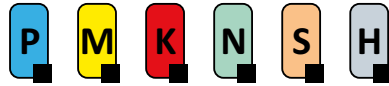

PRAMET

S







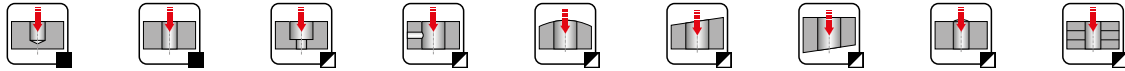
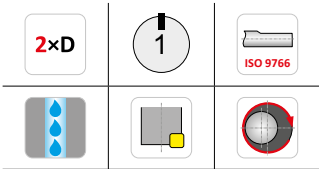
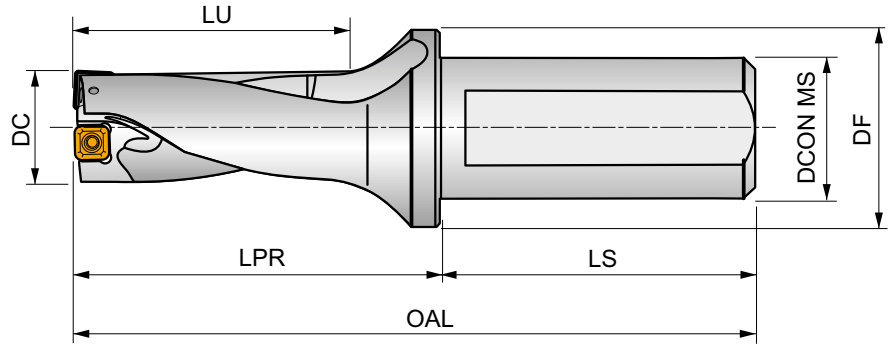



Cuerpo de broca 802D de placa intercambiable 2XD con Refrigeración Interna

Cuerpo de broca de plaquitas intercambiables de alto rendimiento para taladrar agujeros ciegos y pasantes. Potencialmente también taladrado de agujeros cruzados, descentrados y en paquetes de chapas, interpolación helicoidal, fresado axial (plunge), taladrado en superficies cóncavas o en ángulo, taladrado con cortes interrumpidos, achaflanado y mandrinado. Disponible desde Ø15 hasta Ø40 mm en 2xD.



Product	DC	APMX	OAL	LPR	LS	LU	DCON MS	DF	\bar{D}	D^+					
	(mm)	(mm)	(mm)	(mm)	(mm)	(mm)	(mm)	(mm)	(mm)	(mm)			kg		
802D-15-30-S25	15	30.00	121	65	56	34.5	25	35	0.25	0.35	EP253253	GI300	GI313	0.32	HM001
802D-16-32-S25	16	32.00	123	67	56	37	25	35	0.15	0.45	EP253253	GI300	GI313	0.32	HM001
802D-17-34-S25	17	34.00	125	69	56	39.5	25	35	0.10	0.50	EP253253	GI300	GI313	0.31	HM001
802D-18-36-S25	18	36.00	127	71	56	42	25	35	0.35	0.25	EP253253	GI301	GI314	0.31	HM002
802D-19-38-S25	19	38.00	129	73	56	44.5	25	35	0.15	0.45	EP253253	GI301	GI314	0.32	HM002
802D-20-40-S25	20	40.00	131	75	56	47	25	35	0.10	0.45	EP253253	GI302	GI315	0.35	HM003
802D-21-42-S25	21	42.00	133	77	56	49.5	25	35	0.10	0.50	EP253253	GI302	GI315	0.34	HM003
802D-22-44-S25	22	44.00	135	79	56	52	25	35	0.45	0.50	EP253253	GI303	GI316	0.35	HM004
802D-23-46-S25	23	46.00	137	81	56	54.5	25	35	0.35	0.50	EP253253	GI304	GI317	0.36	HM005
802D-24-48-S25	24	48.00	139	83	56	57	25	35	0.15	0.50	EP253253	GI304	GI317	0.37	HM005
802D-25-50-S32	25	50.00	145	85	60	57	32	42	0.15	0.50	EP324058	GI304	GI317	0.57	HM005
802D-26-52-S32	26	52.00	147	87	60	59.5	32	42	0.10	0.50	EP324058	GI304	GI317	0.58	HM005
802D-27-54-S32	27	54.00	149	89	60	62	32	42	0.50	0.30	EP324058	GI305	GI318	0.59	HM006
802D-28-56-S32	28	56.00	151	91	60	64.5	32	42	0.30	0.50	EP324058	GI306	GI319	0.61	HM007
802D-29-58-S32	29	58.00	153	93	60	67	32	42	0.20	0.50	EP324058	GI306	GI319	0.62	HM007
802D-30-60-S32	30	60.00	155	95	60	69.5	32	42	0.15	0.50	EP324058	GI306	GI319	0.67	HM007
802D-32-64-S32	32	64.00	159	99	60	70	32	42	0.50	0.35	EP324058	GI307	GI320	0.68	HM008
802D-32-64-S40	32	64.00	167	99	68	70	40	50	0.50	0.35	-	GI307	GI320	1.03	HM008
802D-34-68-S32	34	68.00	163	103	60	75	32	42	0.25	0.50	EP324058	GI307	GI320	0.73	HM008
802D-34-68-S40	34	68.00	171	103	68	75	40	50	0.25	0.50	-	GI307	GI320	1.07	HM008
802D-36-72-S32	36	72.00	167	107	60	80	32	42	0.10	0.50	EP324058	GI308	GI321	0.76	HM009
802D-36-72-S40	36	72.00	173	105	68	77.5	40	50	0.10	0.50	-	GI308	GI321	1.11	HM009
802D-38-76-S32	38	76.00	171	111	60	85	32	42	0.50	0.50	EP324058	GI308	GI321	0.83	HM009
802D-38-76-S40	38	76.00	179	111	68	85	40	50	0.50	0.50	-	GI308	GI321	1.17	HM009
802D-40-80-S32	40	80.00	175	115	60	90	32	42	0.20	0.50	EP324058	GI309	GI322	0.94	HM009
802D-40-80-S40	40	80.00	183	115	68	90	40	50	0.20	0.50	-	GI309	GI322	1.25	HM009

		
GI300	XPET 0502AP	SCET 050204-UD
GI301	XPET 0602AP	SCET 050204-UD
GI302	XPET 0602AP	SCET 060204-UD
GI303	XPET 0703AP	SCET 060204-UD
GI304	XPET 0703AP	SCET 070308-UD
GI305	XPET 0903AP	SCET 070308-UD
GI306	XPET 0903AP	SCET 09T308-UD
GI307	XPET 11T3AP	SCET 09T308-UD
GI308	XPET 11T3AP	SCET 120408-UD
GI309	XPET 12T3AP	SCET 120408-UD
GI313	XPET 0502AP-SD	SCET 050204-SD
GI314	XPET 0602AP-SD	SCET 050204-SD
GI315	XPET 0602AP-SD	SCET 060204-SD
GI316	XPET 0703AP-SD	SCET 060204-SD
GI317	XPET 0703AP-SD	SCET 070308-SD
GI318	XPET 0903AP-SD	SCET 070308-SD
GI319	XPET 0903AP-SD	SCET 09T308-SD
GI320	XPET 11T3AP-SD	SCET 09T308-SD
GI321	XPET 11T3AP-SD	SCET 120408-SD
GI322	XPET 12T3AP-SD	SCET 120408-SD

					
HM001	US 2245-T07P	0.9	US 2245-T07P	0.9	FLAG T07P
HM002	US 2205-T07P	0.9	US 2245-T07P	0.9	FLAG T07P
HM003	US 2205-T07P	0.9	US 2205-T07P	0.9	FLAG T07P
HM004	US 2506-T07P	1.2	US 2506-T07P	1.2	FLAG T07P
HM005	US 2507-T08P	1.2	US 3007-T08P	2.0	FLAG T08P
HM006	US 3007-T09P	2.0	US 3007-T09P	2.0	FLAG T09P
HM007	US 3007-T09P	2.0	US 3009-T09P	2.0	FLAG T09P
HM008	US 3510-T15P	3.0	US 3508-T15P	3.0	FLAG T15P
HM009	US 3510-T15P	3.0	US 5012-T15P	5.0	FLAG T15P

803D

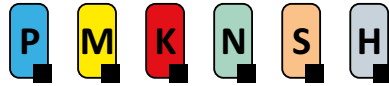

PRAMET

S



Cuerpo de Broca 803D de placa intercambiable 3XD con Refrigeración Interna

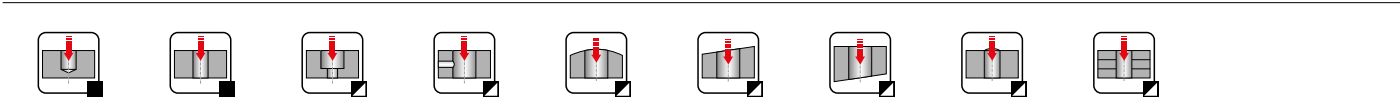
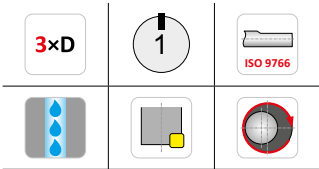
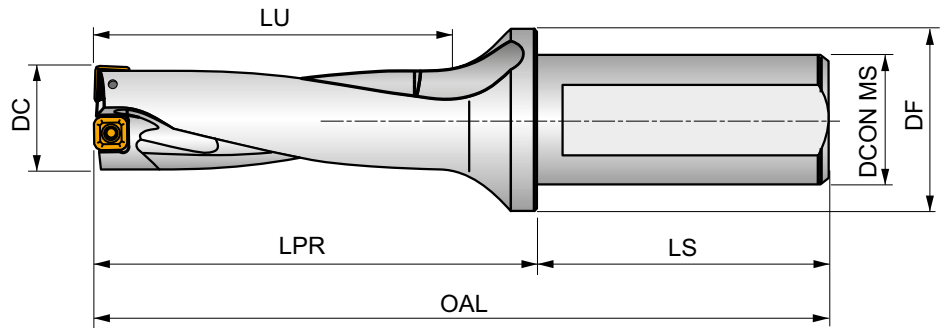

Cuerpo de broca de plaquitas intercambiables de alto rendimiento para taladrar agujeros ciegos y pasantes. Potencialmente también taladrado de agujeros cruzados, descentrados y en paquetes de chapas, interpolación helicoidal, fresado axial (plunge), taladrado en superficies cóncavas o en ángulo, taladrado con cortes interrumpidos, achaflanado y mandrinado. Disponible desde Ø15 hasta Ø58 mm en 3xD.









Product	DC	APMX	OAL	LPR	LS	LU	DCON MS	DF	\bar{D}	D^+					
	(mm)	(mm)	(mm)	(mm)	(mm)	(mm)	(mm)	(mm)	(mm)	(mm)		kg			
803D-15-45-S25	15	45.00	136	80	56	49.5	25	35	0.25	0.35	EP253253	GI300	GI313	0.33	HM001
803D-15,5-46,5-S25	15.5	47.00	137.5	81.5	56	51.2	25	35	0.30	0.35	EP253253	GI300	GI313	0.31	HM001
803D-16-48-S25	16	48.00	139	83	56	53	25	35	0.15	0.45	EP253253	GI300	GI313	0.32	HM001
803D-16,5-49,5-S25	16.5	50.00	140.5	84.5	56	54.7	25	35	0.15	0.40	EP253253	GI300	GI313	0.32	HM001
803D-17-51-S25	17	51.00	142	86	56	56.5	25	35	0.10	0.50	EP253253	GI300	GI313	0.35	HM001
803D-17,5-52,5-S25	17.5	53.00	143.5	87.5	56	58.2	25	35	0.50	0.50	EP253253	GI301	GI314	0.32	HM002
803D-18-54-S25	18	54.00	145	89	56	60	25	35	0.35	0.25	EP253253	GI301	GI314	0.33	HM002
803D-18,5-55,5-S25	18.5	56.00	146.5	90.5	56	61.2	25	35	0.35	0.25	EP253253	GI301	GI314	0.34	HM002
803D-19-57-S25	19	57.00	148	92	56	63.5	25	35	0.15	0.45	EP253253	GI301	GI314	0.34	HM002
803D-19,5-58,5-S25	19.5	59.00	149.5	93.5	56	63.7	25	35	0.25	0.40	EP253253	GI302	GI315	0.34	HM003
803D-20-60-S25	20	60.00	151	95	56	67	25	35	0.10	0.45	EP253253	GI302	GI315	0.33	HM003
803D-20,5-61,5-S25	20.5	62.00	152.5	96.5	56	67.2	25	35	0.10	0.50	EP253253	GI302	GI315	0.36	HM003
803D-21-63-S25	21	63.00	154	98	56	70.5	25	35	0.10	0.50	EP253253	GI302	GI315	0.36	HM003
803D-21,5-64,5-S25	21.5	65.00	155.5	99.5	56	70.8	25	35	0.35	0.50	EP253253	GI303	GI316	0.37	HM004
803D-22-66-S25	22	66.00	157	101	56	74	25	35	0.45	0.50	EP253253	GI303	GI316	0.40	HM004
803D-22,5-67,5-S25	22.5	68.00	158.5	102.5	56	74.3	25	35	0.35	0.50	EP253253	GI304	GI317	0.42	HM005
803D-23-69-S25	23	69.00	160	104	56	77.5	25	35	0.35	0.50	EP253253	GI304	GI317	0.40	HM005
803D-23,5-70,5-S25	23.5	71.00	161.5	105.5	56	77.6	25	35	0.10	0.50	EP253253	GI304	GI317	0.40	HM005
803D-24-72-S25	24	72.00	163	107	56	81	25	35	0.15	0.50	EP253253	GI304	GI317	0.41	HM005
803D-24,5-73,5-S25	24.5	74.00	168.5	108.5	60	78.7	25	35	0.10	0.50	EP253253	GI304	GI317	0.45	HM005
803D-25-75-S32	25	75.00	170	110	60	82	32	42	0.15	0.50	EP324058	GI304	GI317	0.62	HM005
803D-25,5-76,5-S32	25.5	77.00	171.5	111.5	60	82.2	32	42	0.50	0.10	EP324058	GI304	GI317	0.63	HM005
803D-26-78-S32	26	78.00	173	113	60	85.5	32	42	0.10	0.50	EP324058	GI304	GI317	0.66	HM005
803D-26,5-79,5-S32	26.5	80.00	174.5	114.5	60	85.7	32	42	0.50	0.10	EP324058	GI305	GI318	0.67	HM006
803D-27-81-S32	27	81.00	176	116	60	89	32	42	0.50	0.30	EP324058	GI305	GI318	0.65	HM006
803D-28-84-S32	28	84.00	179	119	60	92.5	32	42	0.30	0.50	EP324058	GI306	GI319	0.68	HM007
803D-29-87-S32	29	87.00	182	122	60	96	32	42	0.20	0.50	EP324058	GI306	GI319	0.70	HM007

Product	DC	APMX	OAL	LPR	LS	LU	DCON MS	DF	\bar{D}	D^+					
	(mm)	(mm)	(mm)	(mm)	(mm)	(mm)	(mm)	(mm)	(mm)	(mm)					
803D-30-90-S32	30	90.00	185	125	60	99.5	32	42	0.15	0.50	EP324058	GI306	GI319	0.73	HM007
803D-31-93-S32	31	93.00	188	128	60	103	32	42	0.15	0.50	EP324058	GI306	GI319	0.76	HM007
803D-32-96-S32	32	96.00	191	131	60	102	32	42	0.50	0.30	EP324058	GI307	GI320	0.79	HM008
803D-32-96-S40	32	96.00	199	131	68	102	40	50	0.50	0.30	-	GI307	GI320	1.14	HM008
803D-33-99-S32	33	99.00	194	134	60	105.5	32	42	0.50	0.50	EP324058	GI307	GI320	0.83	HM008
803D-33-99-S40	33	99.00	202	134	68	105.5	40	50	0.50	0.50	-	GI307	GI320	1.18	HM008
803D-34-102-S32	34	102.00	197	137	60	109	32	42	0.25	0.50	EP324058	GI307	GI320	0.86	HM008
803D-34-102-S40	34	102.00	205	137	68	109	40	50	0.25	0.50	-	GI307	GI320	1.12	HM008
803D-35-105-S32	35	105.00	200	140	60	112.5	32	42	0.25	0.50	EP324058	GI308	GI321	0.90	HM009
803D-35-105-S40	35	105.00	208	140	68	112.5	40	50	0.25	0.50	-	GI308	GI321	1.24	HM009
803D-36-108-S32	36	108.00	203	143	60	116	32	42	0.10	0.50	EP324058	GI308	GI321	0.91	HM009
803D-36-108-S40	36	108.00	211	143	68	116	40	50	0.10	0.50	-	GI308	GI321	1.25	HM009
803D-37-111-S32	37	111.00	206	146	60	119.5	32	42	0.10	0.50	EP324058	GI308	GI321	0.95	HM009
803D-37-111-S40	37	111.00	214	146	68	119.5	40	50	0.10	0.50	-	GI308	GI321	1.29	HM009
803D-38-114-S32	38	114.00	199	139	60	124.5	32	42	0.50	0.50	EP324058	GI308	GI321	1.00	HM009
803D-38-114-S40	38	114.00	217	149	68	123	40	50	0.50	0.50	-	GI308	GI321	1.34	HM009
803D-39-117-S32	38	114.00	209	149	60	123	32	42	0.40	0.50	EP324058	GI309	GI322	1.06	HM009
803D-39-117-S40	39	117.00	220	152	68	126.5	40	50	0.40	0.50	-	GI309	GI322	1.40	HM009
803D-40-120-S32	40	120.00	215	155	60	130	32	42	0.20	0.50	EP324058	GI309	GI322	1.12	HM009
803D-40-120-S40	40	120.00	223	155	68	130	40	50	0.20	0.50	-	GI309	GI322	1.46	HM009
803D-41-123-S40	41	123.00	219	149	70	133	40	50	0.20	0.50	-	GI309	GI322	1.48	HM009
803D-42-126-S40	42	126.00	221.5	152	70	136	40	50	0.15	0.50	-	GI309	GI322	1.52	HM009
803D-43-129-S40	43	129.00	224	154	70	139	40	50	0.10	0.50	-	GI309	GI322	1.58	HM009
803D-44-132-S40	44	132.00	226.5	157	70	142	40	50	0.50	0.50	-	GI310	GI323	1.63	HM010
803D-45-135-S40	45	135.00	230.5	161	70	144	40	55	0.50	0.50	-	GI311	GI324	1.73	HM010
803D-46-138-S40	46	138.00	235	165	70	148	40	55	0.50	0.50	-	GI311	GI324	1.82	HM010
803D-47-141-S40	47	141.00	237.5	168	70	151	40	55	0.50	0.50	-	GI311	GI324	1.90	HM010
803D-48-144-S40	48	144.00	240	170	70	154	40	55	0.50	0.50	-	GI311	GI324	1.98	HM010
803D-49-147-S40	49	147.00	242.5	173	70	157	40	55	0.30	0.50	-	GI311	GI324	2.06	HM010
803D-50-150-S40	50	150.00	246.5	177	70	160	40	58	0.15	0.50	-	GI311	GI324	2.18	HM010
803D-51-153-S40	51	153.00	249	179	70	163	40	58	0.15	0.50	-	GI311	GI324	2.24	HM010
803D-52-156-S40	52	156.00	251.5	182	70	166	40	58	0.50	0.50	-	GI312	GI325	2.20	HM010
803D-53-159-S40	53	159.00	254	184	70	169	40	58	0.50	0.50	-	GI312	GI325	2.29	HM010
803D-54-162-S40	54	162.00	257.5	188	70	173	40	58	0.50	0.50	-	GI312	GI325	2.39	HM010
803D-55-165-S40	55	165.00	260	190	70	176	40	58	0.50	0.50	-	GI312	GI325	2.46	HM010
803D-56-168-S40	56	168.00	264	194	70	179	40	58	0.50	0.50	-	GI312	GI325	2.59	HM010
803D-57-171-S40	57	171.00	266.5	197	70	182	40	58	0.35	0.50	-	GI312	GI325	2.70	HM010
803D-58-174-S40	58	174.00	270	200	70	186	40	58	0.15	0.50	-	GI312	GI325	2.83	HM010

GI300	XPET 0502AP	SCET 050204-UD
GI301	XPET 0602AP	SCET 050204-UD
GI302	XPET 0602AP	SCET 060204-UD
GI303	XPET 0703AP	SCET 060204-UD
GI304	XPET 0703AP	SCET 070308-UD
GI305	XPET 0903AP	SCET 070308-UD
GI306	XPET 0903AP	SCET 09T308-UD
GI307	XPET 11T3AP	SCET 09T308-UD
GI308	XPET 11T3AP	SCET 120408-UD
GI309	XPET 12T3AP	SCET 120408-UD
GI310	XPET 1504AP	SCET 120408-UD
GI311	XPET 1504AP	SCET 150512-UD
GI312	XPET 1904AP	SCET 150512-UD
GI313	XPET 0502AP-SD	SCET 050204-SD
GI314	XPET 0602AP-SD	SCET 050204-SD
GI315	XPET 0602AP-SD	SCET 060204-SD
GI316	XPET 0703AP-SD	SCET 060204-SD
GI317	XPET 0703AP-SD	SCET 070308-SD
GI318	XPET 0903AP-SD	SCET 070308-SD
GI319	XPET 0903AP-SD	SCET 09T308-SD

		
GI320	XPET 11T3AP-SD	SCET 09T308-SD
GI321	XPET 11T3AP-SD	SCET 120408-SD
GI322	XPET 12T3AP-SD	SCET 120408-SD
GI323	XPET 1504AP-SD	SCET 120408-SD
GI324	XPET 1504AP-SD	SCET 150512-SD
GI325	XPET 1904AP-SD	SCET 150512-SD

		 Nm		 Nm	
HM001	US 2245-T07P	0.9	US 2245-T07P	0.9	FLAG T07P
HM002	US 2205-T07P	0.9	US 2245-T07P	0.9	FLAG T07P
HM003	US 2205-T07P	0.9	US 2205-T07P	0.9	FLAG T07P
HM004	US 2506-T07P	1.2	US 2506-T07P	1.2	FLAG T07P
HM005	US 2507-T08P	1.2	US 3007-T08P	2.0	FLAG T08P
HM006	US 3007-T09P	2.0	US 3007-T09P	2.0	FLAG T09P
HM007	US 3007-T09P	2.0	US 3009-T09P	2.0	FLAG T09P
HM008	US 3510-T15P	3.0	US 3508-T15P	3.0	FLAG T15P
HM009	US 3510-T15P	3.0	US 5012-T15P	5.0	FLAG T15P
HM010	US 4011-T15P	3.5	US 5012-T15P	5.0	FLAG T15P

804D

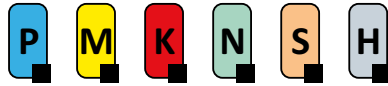

PRAMET

S







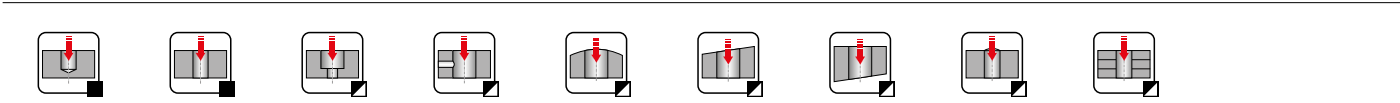
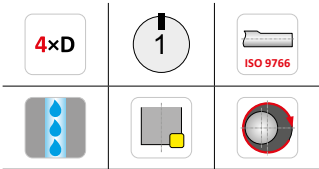
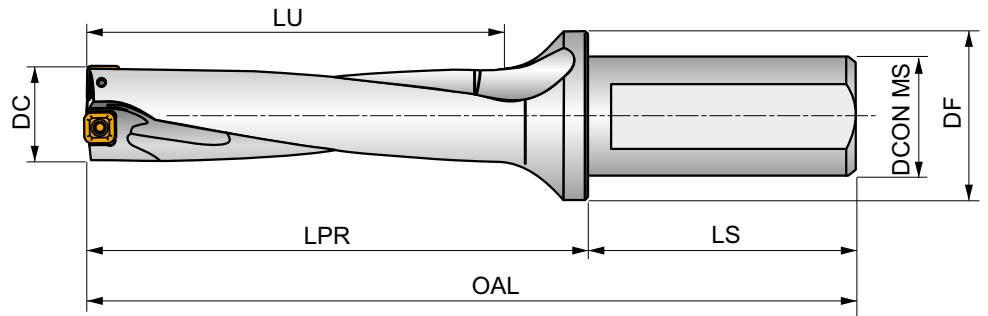



Cuerpo de Broca 804D de placa intercambiable 4XD con Refrigeración Interna







Cuerpo de broca de plaquitas intercambiables de alto rendimiento para taladrar agujeros ciegos y pasantes. Potencialmente también taladrado de agujeros cruzados, descentrados y en paquetes de chapas, interpolación helicoidal, fresado axial (plunge), taladrado en superficies cóncavas o en ángulo, taladrado con cortes interrumpidos, achaflanado y mandrinado. Disponible desde Ø17 hasta Ø58 mm en 4xD.



Product	DC	APMX	OAL	LPR	LS	LU	DCON MS	DF	\bar{D}	\bar{D}^+				kg	
	(mm)	(mm)	(mm)	(mm)	(mm)	(mm)	(mm)	(mm)	(mm)	(mm)					
804D-17-68-S25	17	68.00	149	93	56	73	25	35	0.10	0.50	–	GI300	GI313	0.34	HM001
804D-18-72-S25	18	72.00	153	97	56	77	25	35	0.35	0.25	–	GI301	GI314	0.35	HM002
804D-19-76-S25	19	76.00	157	101	56	81.5	25	35	0.15	0.45	–	GI301	GI314	0.36	HM002
804D-20-80-S25	20	80.00	161	105	56	85	25	35	0.10	0.45	–	GI302	GI315	0.37	HM003
804D-21-84-S25	21	84.00	165	109	56	89.5	25	35	0.10	0.50	–	GI302	GI315	0.43	HM003
804D-22-88-S25	22	88.00	169	113	56	94	25	35	0.45	0.50	–	GI303	GI316	0.45	HM004
804D-23-92-S25	23	92.00	173	117	56	98.5	25	35	0.35	0.50	–	GI304	GI317	0.44	HM005
804D-24-96-S25	24	96.00	177	121	56	103	25	35	0.15	0.50	–	GI304	GI317	0.45	HM005
804D-25-100-S32	25	100.00	185	125	60	105	32	42	0.15	0.50	–	GI304	GI317	0.67	HM005
804D-26-104-S32	26	104.00	189	129	60	109.5	32	42	0.10	0.50	–	GI304	GI317	0.70	HM005
804D-27-108-S32	27	108.00	193	133	60	114	32	42	0.50	0.30	–	GI305	GI318	0.71	HM006
804D-28-112-S32	28	112.00	197	137	60	118.5	32	42	0.30	0.50	–	GI306	GI319	0.75	HM007
804D-29-116-S32	29	116.00	201	141	60	123	32	42	0.20	0.50	–	GI306	GI319	0.78	HM007
804D-30-120-S32	30	120.00	205	145	60	127.5	32	42	0.15	0.50	–	GI306	GI319	0.82	HM007
804D-31-124-S32	31	124.00	209	149	60	132	32	42	0.15	0.50	–	GI306	GI319	0.85	HM007
804D-32-128-S32	32	128.00	213	153	60	136.5	32	42	0.50	0.30	–	GI307	GI320	0.90	HM008
804D-33-132-S32	33	132.00	217	157	60	141	32	42	0.50	0.50	–	GI307	GI320	0.95	HM008
804D-34-136-S32	34	136.00	221	161	60	145.5	32	42	0.25	0.50	–	GI307	GI320	0.99	HM008
804D-35-140-S32	35	140.00	225	165	60	149	32	42	0.25	0.50	–	GI308	GI321	1.04	HM009
804D-36-144-S32	36	144.00	229	169	60	153.5	32	42	0.10	0.50	–	GI308	GI321	1.05	HM009
804D-37-148-S32	37	148.00	233	173	60	158	32	42	0.10	0.50	–	GI308	GI321	1.11	HM009
804D-38-152-S32	38	152.00	237	177	60	162.5	32	42	0.50	0.50	–	GI308	GI321	1.18	HM009
804D-39-156-S32	39	156.00	241	181	60	167	32	42	0.40	0.50	–	GI309	GI322	1.25	HM009
804D-40-160-S32	40	160.00	245	185	60	171.5	32	42	0.20	0.50	–	GI309	GI322	1.33	HM009
804D-41-164-S40	41	164.00	259	189	70	172	40	50	0.20	0.50	–	GI309	GI322	1.68	HM009
804D-42-168-S40	42	168.00	263	193	70	176.5	40	50	0.15	0.50	–	GI309	GI322	1.76	HM009
804D-43-172-S40	43	172.00	267	197	70	181	40	50	0.10	0.50	–	GI309	GI322	1.83	HM009

Product	DC	APMX	OAL	LPR	LS	LU	DCON MS	DF	\bar{D}	D^+					
	(mm)	(mm)	(mm)	(mm)	(mm)	(mm)	(mm)	(mm)	(mm)	(mm)				kg	
804D-44-176-S40	44	176.00	271	201	70	185.5	40	50	0.50	0.50	–	GI310	GI323	1.91	HM010
804D-45-180-S40	45	180.00	275	205	70	187.5	40	55	0.50	0.50	–	GI311	GI324	2.02	HM010
804D-46-184-S40	46	184.00	279	209	70	192	40	55	0.50	0.50	–	GI311	GI324	2.12	HM010
804D-47-188-S40	47	188.00	283	213	70	196.5	40	55	0.50	0.50	–	GI311	GI324	2.22	HM010
804D-48-192-S40	48	192.00	287	217	70	201	40	55	0.50	0.50	–	GI311	GI324	2.33	HM010
804D-49-196-S40	49	196.00	291	221	70	205.5	40	55	0.30	0.50	–	GI311	GI324	2.45	HM010
804D-50-200-S40	50	200.00	295	225	70	208.5	40	58	0.15	0.50	–	GI311	GI324	2.58	HM010
804D-51-204-S40	51	204.00	299	229	70	213	40	58	0.15	0.50	–	GI311	GI324	2.68	HM010
804D-52-208-S40	52	208.00	303	233	70	217.5	40	58	0.50	0.50	–	GI312	GI325	2.64	HM010
804D-53-212-S40	53	212.00	307	237	70	222	40	58	0.50	0.50	–	GI312	GI325	2.76	HM010
804D-54-216-S40	54	216.00	311	241	70	226.5	40	58	0.50	0.50	–	GI312	GI325	2.90	HM010
804D-55-220-S40	55	220.00	315	245	70	231	40	58	0.50	0.50	–	GI312	GI325	3.00	HM010
804D-56-224-S40	56	224.00	319	249	70	235.5	40	58	0.50	0.50	–	GI312	GI325	3.15	HM010
804D-57-228-S40	57	228.00	323	253	70	240	40	58	0.35	0.50	–	GI312	GI325	3.30	HM010
804D-58-232-S40	58	232.00	327	257	70	244.5	40	58	0.15	0.50	–	GI312	GI325	3.46	HM010

		
GI300	XPET 0502AP	SCET 050204-UD
GI301	XPET 0602AP	SCET 050204-UD
GI302	XPET 0602AP	SCET 060204-UD
GI303	XPET 0703AP	SCET 060204-UD
GI304	XPET 0703AP	SCET 070308-UD
GI305	XPET 0903AP	SCET 070308-UD
GI306	XPET 0903AP	SCET 09T308-UD
GI307	XPET 11T3AP	SCET 09T308-UD
GI308	XPET 11T3AP	SCET 120408-UD
GI309	XPET 12T3AP	SCET 120408-UD
GI310	XPET 1504AP	SCET 120408-UD
GI311	XPET 1504AP	SCET 150512-UD
GI312	XPET 1904AP	SCET 150512-UD
GI313	XPET 0502AP-SD	SCET 050204-SD
GI314	XPET 0602AP-SD	SCET 050204-SD
GI315	XPET 0602AP-SD	SCET 060204-SD
GI316	XPET 0703AP-SD	SCET 060204-SD
GI317	XPET 0703AP-SD	SCET 070308-SD
GI318	XPET 0903AP-SD	SCET 070308-SD
GI319	XPET 0903AP-SD	SCET 09T308-SD
GI320	XPET 11T3AP-SD	SCET 09T308-SD
GI321	XPET 11T3AP-SD	SCET 120408-SD
GI322	XPET 12T3AP-SD	SCET 120408-SD
GI323	XPET 1504AP-SD	SCET 120408-SD
GI324	XPET 1504AP-SD	SCET 150512-SD
GI325	XPET 1904AP-SD	SCET 150512-SD

					
HM001	US 2245-T07P	0.9	US 2245-T07P	0.9	FLAG T07P
HM002	US 2205-T07P	0.9	US 2245-T07P	0.9	FLAG T07P
HM003	US 2205-T07P	0.9	US 2205-T07P	0.9	FLAG T07P
HM004	US 2506-T07P	1.2	US 2506-T07P	1.2	FLAG T07P
HM005	US 2507-T08P	1.2	US 3007-T08P	2.0	FLAG T08P
HM006	US 3007-T09P	2.0	US 3007-T09P	2.0	FLAG T09P
HM007	US 3007-T09P	2.0	US 3009-T09P	2.0	FLAG T09P
HM008	US 3510-T15P	3.0	US 3508-T15P	3.0	FLAG T15P
HM009	US 3510-T15P	3.0	US 5012-T15P	5.0	FLAG T15P
HM010	US 4011-T15P	3.5	US 5012-T15P	5.0	FLAG T15P

805D

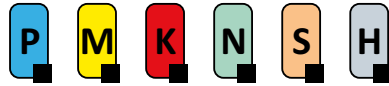

PRAMET







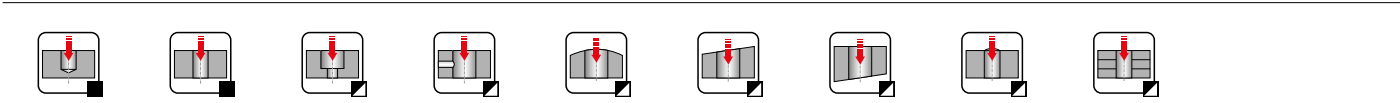
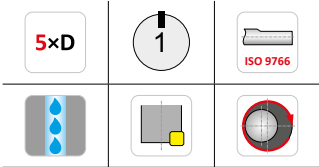
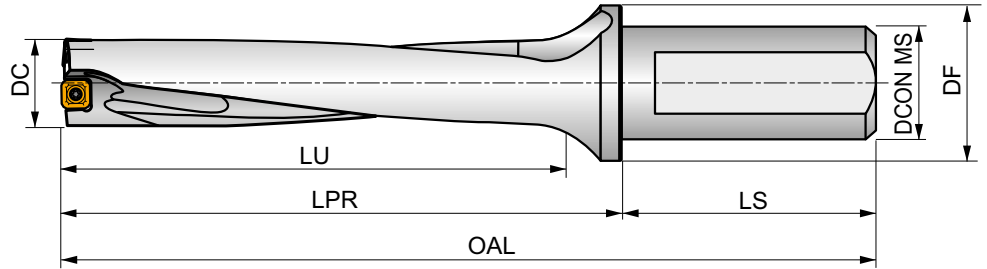

Cuerpo de Broca 805D de placa intercambiable 5XD con Refrigeración Interna

Cuerpo de broca de plaquitas intercambiables de alto rendimiento para taladrar agujeros ciegos y pasantes. Potencialmente también taladrado de agujeros cruzados, descentrados y en paquetes de chapas, interpolación helicoidal, fresado axial (plunge), taladrado en superficies cóncavas o en ángulo, taladrado con cortes interrumpidos, achaflanado y mandrinado. Disponible desde Ø19 hasta Ø31 mm en 5xD.



Product	DC	APMX	OAL	LPR	LS	LU	DCON MS	DF	\bar{D}	\bar{D}^+				kg	
	(mm)	(mm)	(mm)	(mm)	(mm)	(mm)	(mm)	(mm)	(mm)	(mm)					
805D-19-95-S25	19	95.00	176	120	56	100.5	25	35	0.15	0.45	–	GI301	GI314	0.38	HM002
805D-20-100-S25	20	100.00	181	125	56	105	25	35	0.10	0.45	–	GI302	GI315	0.40	HM003
805D-21-105-S25	21	105.00	186	130	56	110.5	25	35	0.10	0.50	–	GI302	GI315	0.42	HM003
805D-22-110-S25	22	110.00	191	135	56	116	25	35	0.45	0.50	–	GI303	GI316	0.45	HM004
805D-23-115-S25	23	115.00	196	140	56	121.5	25	35	0.35	0.50	–	GI304	GI317	0.48	HM005
805D-24-120-S25	24	120.00	201	145	56	127	25	35	0.15	0.50	–	GI304	GI317	0.49	HM005
805D-25-125-S32	25	125.00	210	150	60	130	32	42	0.15	0.50	–	GI304	GI317	0.72	HM005
805D-26-130-S32	26	130.00	215	155	60	135.5	32	42	0.10	0.50	–	GI304	GI317	0.82	HM005
805D-27-135-S32	27	135.00	220	160	60	141	32	42	0.50	0.30	–	GI305	GI318	0.78	HM006
805D-28-140-S32	28	140.00	225	165	60	146.5	32	42	0.30	0.50	–	GI306	GI319	0.82	HM007
805D-29-145-S32	29	145.00	230	170	60	152	32	42	0.20	0.50	–	GI306	GI319	0.86	HM007
805D-30-150-S32	30	150.00	235	175	60	157.5	32	42	0.15	0.50	–	GI306	GI319	0.90	HM007
805D-31-155-S32	31	155.00	240	180	60	163	32	42	0.15	0.50	–	GI306	GI319	0.95	HM007

GI301	XPET 0602AP	SCET 050204-UD
GI302	XPET 0602AP	SCET 060204-UD
GI303	XPET 0703AP	SCET 060204-UD
GI304	XPET 0703AP	SCET 070308-UD
GI305	XPET 0903AP	SCET 070308-UD
GI306	XPET 0903AP	SCET 09T308-UD
GI314	XPET 0602AP-SD	SCET 050204-SD
GI315	XPET 0602AP-SD	SCET 060204-SD
GI316	XPET 0703AP-SD	SCET 060204-SD
GI317	XPET 0703AP-SD	SCET 070308-SD
GI318	XPET 0903AP-SD	SCET 070308-SD
GI319	XPET 0903AP-SD	SCET 09T308-SD

					
HM002	US 2205-T07P	0.9	US 2245-T07P	0.9	FLAG T07P
HM003	US 2205-T07P	0.9	US 2205-T07P	0.9	FLAG T07P
HM004	US 2506-T07P	1.2	US 2506-T07P	1.2	FLAG T07P
HM005	US 2507-T08P	1.2	US 3007-T08P	2.0	FLAG T08P
HM006	US 3007-T09P	2.0	US 3007-T09P	2.0	FLAG T09P
HM007	US 3007-T09P	2.0	US 3009-T09P	2.0	FLAG T09P

SCET



	IC (mm)	D1 (mm)	L (mm)	S (mm)
0502	5.556	2.40	5.56	2.38
0602	6.350	2.90	6.35	2.38
0703	7.937	3.50	7.94	3.18
09T3	9.525	4.50	9.53	3.97
1204	12.700	5.60	12.70	4.76
1505	15.875	5.60	15.88	5.56

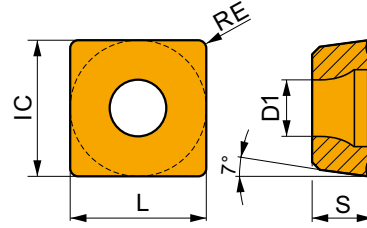

Valores de inicio adecuados para la velocidad de corte (vc), avance (f) y profundidad de corte (ap). Consulte nuestra APP Calculadora de mecanizado para obtener más cálculos.

Product	Intermittent/ Continuous cut	RE (mm)	P			M			K			N			S			H		
			vc (m/min)	f (mm/rev)	ap (mm)	vc (m/min)	f (mm/rev)	ap (mm)	vc (m/min)	f (mm/rev)	ap (mm)	vc (m/min)	f (mm/rev)	ap (mm)	vc (m/min)	f (mm/rev)	ap (mm)	vc (m/min)	f (mm/rev)	ap (mm)



SCET 050204-UD 0.12
 SCET 060204-UD 0.15
 SCET 070308-UD 0.15
 SCET 09T308-UD 0.15
 SCET 120408-UD 0.20
 SCET 150512-UD 0.20



Geometría UD con diseño universal para plaquitas periféricas.

SCET 050204-UD:D8330	●	0.4	165	0.08	-	-	-	-	155	0.08	-	-	-	-	-	-	-	-	-
SCET 050204-UD:D9335	●	0.4	240	0.08	-	-	-	-	225	0.08	-	-	-	-	-	-	-	-	-
SCET 060204-UD:D8330	●	0.4	165	0.11	-	-	-	-	155	0.11	-	-	-	-	-	-	-	-	-
SCET 060204-UD:D9335	●	0.4	240	0.11	-	-	-	-	225	0.11	-	-	-	-	-	-	-	-	-
SCET 070308-UD:D8330	●	0.8	165	0.13	-	-	-	-	155	0.13	-	-	-	-	-	-	-	-	-
SCET 070308-UD:D9335	●	0.8	240	0.13	-	-	-	-	225	0.13	-	-	-	-	-	-	-	-	-
SCET 09T308-UD:D8330	●	0.8	165	0.14	-	-	-	-	155	0.14	-	-	-	-	-	-	-	-	-
SCET 09T308-UD:D9335	●	0.8	240	0.14	-	-	-	-	225	0.14	-	-	-	-	-	-	-	-	-
SCET 120408-UD:D8330	●	0.8	165	0.16	-	-	-	-	155	0.16	-	-	-	-	-	-	-	-	-
SCET 120408-UD:D9335	●	0.8	240	0.16	-	-	-	-	225	0.16	-	-	-	-	-	-	-	-	-
SCET 150512-UD:D8330	●	1.2	165	0.18	-	-	-	-	155	0.18	-	-	-	-	-	-	-	-	-
SCET 150512-UD:D9335	●	1.2	240	0.18	-	-	-	-	225	0.18	-	-	-	-	-	-	-	-	-

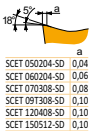

SCET 050204-SD 0.04
 SCET 060204-SD 0.06
 SCET 070308-SD 0.08
 SCET 09T308-SD 0.10
 SCET 120408-SD 0.10
 SCET 150512-SD 0.10



Geometría SD con diseño positivo para plaquitas periféricas.

SCET 050204-SD:D8330	●	0.4	165	0.08	-	95	0.07	-	155	0.08	-	-	-	40	0.06	-	-	-	-
SCET 050204-SD:D9335	●	0.4	240	0.08	-	140	0.07	-	225	0.08	-	-	-	60	0.06	-	-	-	-
SCET 060204-SD:D8330	●	0.4	165	0.11	-	95	0.09	-	155	0.11	-	-	-	40	0.07	-	-	-	-
SCET 060204-SD:D9335	●	0.4	240	0.11	-	140	0.09	-	225	0.11	-	-	-	60	0.07	-	-	-	-
SCET 070308-SD:D8330	●	0.8	165	0.13	-	95	0.11	-	155	0.13	-	-	-	40	0.09	-	-	-	-
SCET 070308-SD:D9335	●	0.8	240	0.13	-	140	0.11	-	225	0.13	-	-	-	60	0.09	-	-	-	-
SCET 09T308-SD:D8330	●	0.8	165	0.14	-	95	0.13	-	155	0.14	-	-	-	40	0.10	-	-	-	-
SCET 09T308-SD:D9335	●	0.8	240	0.14	-	140	0.13	-	225	0.14	-	-	-	60	0.10	-	-	-	-
SCET 120408-SD:D8330	●	0.8	165	0.16	-	95	0.14	-	155	0.16	-	-	-	40	0.11	-	-	-	-
SCET 120408-SD:D9335	●	0.8	240	0.16	-	140	0.14	-	225	0.16	-	-	-	60	0.11	-	-	-	-
SCET 150512-SD:D8330	●	1.2	165	0.18	-	95	0.16	-	155	0.18	-	-	-	40	0.12	-	-	-	-
SCET 150512-SD:D9335	●	1.2	240	0.18	-	140	0.16	-	225	0.18	-	-	-	60	0.12	-	-	-	-

XPET



	IC (mm)	D1 (mm)	L (mm)	S (mm)
0502	5.556	2.40	5.56	2.38
0602	6.350	2.60	6.35	2.38
0703	7.937	2.90	7.94	3.18
0903	9.525	3.50	9.53	3.18
11T3	11.509	3.90	11.50	3.97
12T3	12.700	3.90	12.70	3.97
1504	15.875	4.50	15.88	4.76
1904	19.050	4.50	19.05	4.76

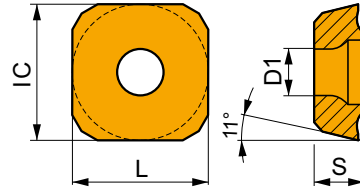

Valores de inicio adecuados para la velocidad de corte (vc), avance (f) y profundidad de corte (ap). Consulte nuestra APP Calculadora de mecanizado para obtener más cálculos.

Product	Incrumfeed/ Continuous cut (mm)	RE (mm)	P			M			K			N			S			H		
			vc (m/min)	f (mm/rev)	ap (mm)	vc (m/min)	f (mm/rev)	ap (mm)	vc (m/min)	f (mm/rev)	ap (mm)	vc (m/min)	f (mm/rev)	ap (mm)	vc (m/min)	f (mm/rev)	ap (mm)	vc (m/min)	f (mm/rev)	ap (mm)

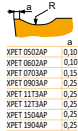

XPET 0502AP	0,10
XPET 0602AP	0,10
XPET 0703AP	0,15
XPET 0903AP	0,25
XPET 11T3AP	0,25
XPET 12T3AP	0,25
XPET 1504AP	0,25
XPET 1904AP	0,25



Geometría de diseño universal para plaquitas centrales.

XPET 0502AP:D8345	☹	—	■	165	0.08	—	—	—	—	■	155	0.08	—	—	—	—	—	—	—	—	—	—
XPET 0602AP:D8345	☹	—	■	165	0.11	—	—	—	—	■	155	0.11	—	—	—	—	—	—	—	—	—	—
XPET 0703AP:D8345	☹	—	■	165	0.13	—	—	—	—	■	155	0.13	—	—	—	—	—	—	—	—	—	—
XPET 0903AP:D8345	☹	—	■	165	0.14	—	—	—	—	■	155	0.14	—	—	—	—	—	—	—	—	—	—
XPET 11T3AP:D8345	☹	—	■	165	0.16	—	—	—	—	■	155	0.16	—	—	—	—	—	—	—	—	—	—
XPET 12T3AP:D8345	☹	—	■	165	0.16	—	—	—	—	■	155	0.16	—	—	—	—	—	—	—	—	—	—
XPET 1504AP:D8345	☹	—	■	165	0.18	—	—	—	—	■	155	0.18	—	—	—	—	—	—	—	—	—	—
XPET 1904AP:D8345	☹	—	■	165	0.18	—	—	—	—	■	155	0.18	—	—	—	—	—	—	—	—	—	—

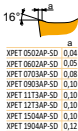

XPET 0502AP-SD	0,04
XPET 0602AP-SD	0,05
XPET 0703AP-SD	0,08
XPET 0903AP-SD	0,10
XPET 11T3AP-SD	0,10
XPET 12T3AP-SD	0,10
XPET 1504AP-SD	0,10
XPET 1904AP-SD	0,12



Geometría SD con diseño positivo para plaquitas centrales.

XPET 0502AP-SD:D8345	☹	—	■	165	0.08	—	■	95	0.07	—	■	155	0.08	—	—	—	■	40	0.06	—	—	—
XPET 0602AP-SD:D8345	☹	—	■	165	0.11	—	■	95	0.09	—	■	155	0.11	—	—	—	■	40	0.07	—	—	—
XPET 0703AP-SD:D8345	☹	—	■	165	0.13	—	■	95	0.11	—	■	155	0.13	—	—	—	■	40	0.09	—	—	—
XPET 0903AP-SD:D8345	☹	—	■	165	0.14	—	■	95	0.13	—	■	155	0.14	—	—	—	■	40	0.10	—	—	—
XPET 11T3AP-SD:D8345	☹	—	■	165	0.16	—	■	95	0.14	—	■	155	0.16	—	—	—	■	40	0.11	—	—	—
XPET 12T3AP-SD:D8345	☹	—	■	165	0.16	—	■	95	0.14	—	■	155	0.16	—	—	—	■	40	0.11	—	—	—
XPET 1504AP-SD:D8345	☹	—	■	165	0.18	—	■	95	0.16	—	■	155	0.18	—	—	—	■	40	0.12	—	—	—
XPET 1904AP-SD:D8345	☹	—	■	165	0.18	—	■	95	0.16	—	■	155	0.18	—	—	—	■	40	0.12	—	—	—



EP



Casquillo de Ajuste para Brocas de Plaquita Intercambiable

Manguito para ajustar el diámetro de la broca de plaquitas intercambiables. Se puede utilizar en portaherramientas Weldon de Ø32, Ø40 o Ø50 mm. El diámetro exterior de la broca se ajusta girando el manguito.

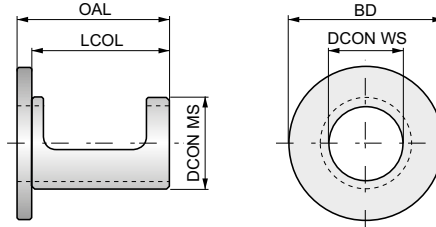

El rango de ajuste del diámetro es 0.4 – -0.2; rango de ajuste de altura central es 0.2 – -0.15.

Product	DCON WS (mm)	DCON MS (mm)	BD (mm)	OAL (mm)	LCOL (mm)	kg
EP253253	25.00	32.00	53.00	53.0	48	0.15
EP324058	32.00	40.00	58.00	58.0	53	0.19
EP405085-F	40.00	50.00	76.00	85.0	80	0.25

Código de Material (BMC)	HM	HM	HM	HM	HM								
Recubrimiento	Bright	Bright	Bright	Bright	Bright								
Grupo básico estándar (BSG)	DIN 8093	DIN 8093	DIN 8050	DIN 8094	DIN 8051								
Mano (dirección de corte)	R	R	R	R	R								
Mango													
Forma del Escariador	B	B	A	B	A								
Tolerancia del agujero alcanzable (TCHA)	H7	$\begin{matrix} \phi 95.5-5 \\ +0.004 \\ \phi 5.51-12 \\ +0.005 \end{matrix}$	H7	H7	H7								



Código de Familia de Producto	B400	B481	B441	B411	B442								
Gama de diámetros de corte PSF	1.00 - 20.00	0.98 - 12.05	10.00 - 20.00	5.00 - 30.00	10.00 - 20.00								
	250	251	253	254	255								

P	P1	■	■	■	■	■							
	P2	■	■	■	■	■							
	P3	■	■	■	■	■							
	P4	■	■	■	■	■							
M	M1	▣	▣	▣	▣	▣							
	M2	▣	▣	▣	▣	▣							
	M3												
	M4												
K	K1	■	■	■	■	■							
	K2	■	■	■	■	■							
	K3	■	■	■	■	■							
	K4												
	K5	■	■	■	■	■							
N	N1	■	■	■	■	■							
	N2	■	■	■	■	■							
	N3	■	■	■	■	■							
	N4	▣	▣	▣	▣	▣							
	N5												
S	S1												
	S2												
	S3												
	S4												
H	H1												
	H2												
	H3												
	H4												

B400



Escariador de Máquina de Metal Duro, Espacio Desigual, con Tolerancia H7, Acabado Brillante

Diseñado para proporcionar un acabado dentro de los límites de la tolerancia H7. Para un rendimiento superior y una mayor vida útil de la herramienta al escariar materiales duros y abrasivos. El diseño helicoidal, con un espaciado extremadamente desigual entre los canales, reduce la vibración y mejora la redondez del agujero, el tamaño y el acabado superficial.

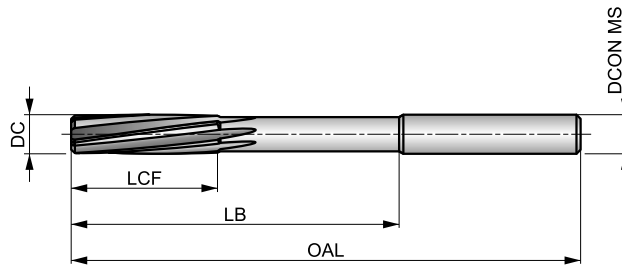

HM	Bright	DIN 8093
R		B
H7		

Grupo de Material de la pieza adecuado y condiciones de velocidad de corte iniciales (m/min) y código de avance alfabético. Tablas con avance por revolución a partir de la pag.279.

P1.1 ■ 23 B	P1.2 ■ 26 B	P1.3 ■ 27 B	P2.1 ■ 20 B	P2.2 ■ 18 B	P2.3 ■ 16 C	P3.1 ■ 16 B	P3.2 ■ 13 B	P3.3 ■ 11 C	P4.1 ■ 10 B	P4.2 ■ 8 C	P4.3 ■ 7 C	M1.1 ▣ 10 C	M1.2 ▣ 8 C
M2.1 ▣ 9 C	M2.2 ▣ 17 C	M2.3 ▣ 16 B	K1.1 ■ 20 D	K1.2 ■ 15 D	K1.3 ■ 11 D	K2.1 ■ 21 D	K2.2 ■ 17 D	K2.3 ■ 14 D	K3.1 ■ 18 D	K3.2 ■ 14 D	K3.3 ■ 11 D	K5.1 ■ 19 D	K5.2 ■ 15 D
K5.3 ■ 11 D	N1.1 ▣ 60 D	N1.2 ■ 45 D	N1.3 ■ 30 D	N2.1 ■ 38 D	N2.2 ■ 35 D	N2.3 ■ 25 D	N3.1 ■ 64 E	N3.2 ■ 38 E	N3.3 ▣ 19 E	N4.1 ▣ 35 C	N4.2 ▣ 30 C		

DCON MS tolerancia h6; DC>= 14 mm con Punta de Metal Duro

Product	DC (mm)	OAL (mm)	LCF (mm)	LB (mm)	NOF	DCON MS (mm)
B4001.0	1.00	34.0	5.5	15.00	3	1.00
B4001.2	1.20	38.0	7.5	16.50	3	1.20
B4001.4	1.40	40.0	8.0	18.00	3	1.50
B4001.5	1.50	40.0	8.0	18.00	3	1.50
B4001.6	1.60	43.0	9.0	20.00	3	1.60
B4001.8	1.80	46.0	10.0	22.00	4	1.80
B4002.0	2.00	49.0	11.0	24.00	4	2.00
B4002.2	2.20	53.0	12.0	25.00	4	2.20
B4002.5	2.50	57.0	14.0	29.00	4	2.50
B4002.8	2.80	61.0	15.0	33.00	6	3.00
B4003.0	3.00	61.0	15.0	33.00	6	3.00
B4003.2	3.20	65.0	16.0	37.00	6	3.20
B4003.5	3.50	70.0	18.0	42.00	6	3.50
B4004.0	4.00	75.0	19.0	47.00	6	4.00

Product	DC (mm)	OAL (mm)	LCF (mm)	LB (mm)	NOF	DCON MS (mm)
B4004.5	4.50	80.0	21.0	52.00	6	4.50
B4005.0	5.00	86.0	23.0	58.00	6	5.00
B4005.5	5.50	93.0	26.0	57.00	6	5.60
B4006.0	6.00	93.0	26.0	57.00	6	5.60
B4006.5	6.50	101.0	28.0	65.00	6	6.30
B4007.0	7.00	109.0	31.0	73.00	6	7.10
B4008.0	8.00	117.0	33.0	81.00	6	8.00
B4009.0	9.00	125.0	36.0	85.00	6	9.00
B40010.0	10.00	133.0	38.0	93.00	6	10.00
B40012.0	12.00	151.0	44.0	111.00	6	10.00
B40014.0	14.00	160.0	47.0	115.00	6	12.50
B40016.0	16.00	170.0	52.0	125.00	6	12.50
B40018.0	18.00	182.0	56.0	137.00	6	14.00
B40020.0	20.00	195.0	60.0	147.00	6	16.00

B481



Escariador de Máquina de Metal Duro, Centesimal, Incrementos de 0.01 mm, Acabado Brillante

Mango recto para alto rendimiento en mecanizado CNC. Los diferentes tamaños permiten producir tolerancias de agujero precisas. Los filos de metal duro de primera calidad brindan un rendimiento muy mejorado y una mayor vida útil de la herramienta al escariar materiales duros y abrasivos. Espaciado extremadamente desigual en los canales para reducir la vibración.

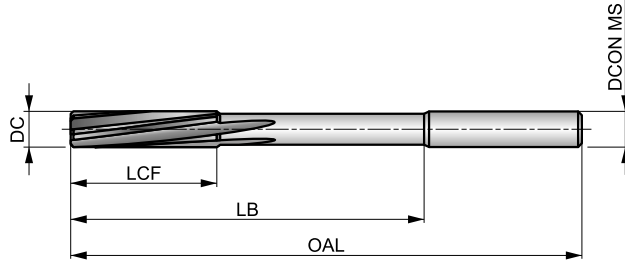

HM	Bright	DIN 8093
R	DIN 6535HA	B
ø 95-5.5 +0.004 ø 5.51-12 +0.005		

Grupo de Material de la pieza adecuado y condiciones de velocidad de corte iniciales (m/min) y código de avance alfabético. Tablas con avance por revolución a partir de la pag.279.

P1.1 ■ 23 B	P1.2 ■ 26 B	P1.3 ■ 27 B	P2.1 ■ 20 B	P2.2 ■ 18 B	P2.3 ■ 16 C	P3.1 ■ 16 B	P3.2 ■ 13 B	P3.3 ■ 11 C	P4.1 ■ 10 B	P4.2 ■ 8 C	P4.3 ■ 7 C	M1.1 ▣ 10 C	M1.2 ▣ 8 C
M2.1 ▣ 9 C	M2.2 ▣ 7 C	M2.3 ▣ 6 B	K1.1 ■ 20 D	K1.2 ■ 15 D	K1.3 ■ 11 D	K2.1 ■ 21 D	K2.2 ■ 17 D	K2.3 ■ 14 D	K3.1 ■ 18 D	K3.2 ■ 14 D	K3.3 ■ 11 D	K5.1 ■ 19 D	K5.2 ■ 15 D
K5.3 ■ 11 D	N1.1 ▣ 60 D	N1.2 ■ 45 D	N1.3 ■ 30 D	N2.1 ■ 38 D	N2.2 ■ 35 D	N2.3 ■ 25 D	N3.1 ■ 64 E	N3.2 ■ 38 E	N3.3 ▣ 19 E	N4.1 ▣ 35 C	N4.2 ▣ 30 C		

DCON MS tolerancia h6.

Product	DC	OAL	LCF	LB	NOF	DCON MS
	(mm)	(mm)	(mm)	(mm)		(mm)
B4810.98	0.98	50.0	6.0	22.00	3	3.00
B4810.99	0.99	50.0	6.0	22.00	3	3.00
B4811.03	1.03	50.0	6.0	22.00	3	3.00
B4811.50	1.50	50.0	9.0	22.00	3	3.00
B4811.51	1.51	50.0	10.0	22.00	3	3.00
B4811.52	1.52	50.0	10.0	22.00	3	3.00
B4811.53	1.53	50.0	10.0	22.00	3	3.00
B4811.98	1.98	50.0	12.0	22.00	4	3.00
B4811.99	1.99	50.0	12.0	22.00	4	3.00
B4812.00	2.00	50.0	12.0	22.00	4	3.00
B4812.01	2.01	50.0	12.0	22.00	4	3.00
B4812.02	2.02	50.0	12.0	22.00	4	3.00
B4812.03	2.03	50.0	12.0	22.00	4	3.00
B4812.48	2.48	60.0	16.0	32.00	4	3.00
B4812.49	2.49	60.0	16.0	32.00	4	3.00
B4812.50	2.50	60.0	16.0	32.00	4	3.00
B4812.51	2.51	60.0	16.0	32.00	4	3.00
B4812.52	2.52	60.0	16.0	32.00	4	3.00
B4812.53	2.53	60.0	16.0	32.00	4	3.00
B4812.97	2.97	65.0	17.0	37.00	6	4.00
B4812.98	2.98	65.0	17.0	37.00	6	4.00
B4812.99	2.99	65.0	17.0	37.00	6	4.00
B4813.00	3.00	65.0	17.0	37.00	6	4.00
B4813.01	3.01	65.0	17.0	37.00	6	4.00
B4813.02	3.02	65.0	17.0	37.00	6	4.00
B4813.03	3.03	65.0	17.0	37.00	6	4.00
B4813.97	3.97	75.0	19.0	47.00	6	4.00

Product	DC	OAL	LCF	LB	NOF	DCON MS
	(mm)	(mm)	(mm)	(mm)		(mm)
B4813.98	3.98	75.0	19.0	47.00	6	4.00
B4813.99	3.99	75.0	19.0	47.00	6	4.00
B4814.00	4.00	75.0	19.0	47.00	6	4.00
B4814.01	4.01	75.0	19.0	47.00	6	4.00
B4814.02	4.02	75.0	19.0	47.00	6	4.00
B4814.03	4.03	75.0	19.0	47.00	6	4.00
B4814.97	4.97	93.0	23.0	57.00	6	6.00
B4814.98	4.98	93.0	23.0	57.00	6	6.00
B4814.99	4.99	93.0	23.0	57.00	6	6.00
B4815.00	5.00	93.0	23.0	57.00	6	6.00
B4815.01	5.01	93.0	23.0	57.00	6	6.00
B4815.02	5.02	93.0	23.0	57.00	6	6.00
B4815.03	5.03	93.0	23.0	57.00	6	6.00
B4815.97	5.97	93.0	26.0	57.00	6	6.00
B4815.98	5.98	93.0	26.0	57.00	6	6.00
B4815.99	5.99	93.0	26.0	57.00	6	6.00
B4816.00	6.00	93.0	26.0	57.00	6	6.00
B4816.01	6.01	93.0	26.0	57.00	6	6.00
B4816.02	6.02	93.0	26.0	57.00	6	6.00
B4816.03	6.03	93.0	26.0	57.00	6	6.00
B4817.97	7.97	117.0	33.0	81.00	6	8.00
B4817.98	7.98	117.0	33.0	81.00	6	8.00
B4817.99	7.99	117.0	33.0	81.00	6	8.00
B4818.00	8.00	117.0	33.0	81.00	6	8.00
B4818.01	8.01	117.0	33.0	81.00	6	8.00
B4818.02	8.02	117.0	33.0	81.00	6	8.00
B4818.03	8.03	117.0	33.0	81.00	6	8.00



Product	DC	OAL	LCF	LB	NOF	DCON MS
	(mm)	(mm)	(mm)	(mm)		(mm)
B4818.04	8.04	117.0	33.0	81.00	6	8.00
B4819.97	9.97	133.0	38.0	93.00	6	10.00
B4819.98	9.98	133.0	38.0	93.00	6	10.00
B4819.99	9.99	133.0	38.0	93.00	6	10.00
B48110.00	10.00	133.0	38.0	93.00	6	10.00
B48110.01	10.01	133.0	38.0	93.00	6	10.00
B48110.02	10.02	133.0	38.0	93.00	6	10.00
B48110.03	10.03	133.0	38.0	93.00	6	10.00
B48110.04	10.04	133.0	38.0	93.00	6	10.00

Product	DC	OAL	LCF	LB	NOF	DCON MS
	(mm)	(mm)	(mm)	(mm)		(mm)
B48110.05	10.05	133.0	38.0	93.00	6	10.00
B48111.98	11.98	151.0	44.0	106.00	6	12.00
B48111.99	11.99	151.0	44.0	106.00	6	12.00
B48112.00	12.00	151.0	44.0	106.00	6	12.00
B48112.01	12.01	151.0	44.0	106.00	6	12.00
B48112.02	12.02	151.0	44.0	106.00	6	12.00
B48112.03	12.03	151.0	44.0	106.00	6	12.00
B48112.04	12.04	151.0	44.0	106.00	6	12.00
B48112.05	12.05	151.0	44.0	106.00	6	12.00

B441



Escariador de Máquina con Punta de Metal Duro, Mango Cilíndrico, Tolerancia H7, Acabado Brillante

La cabeza de metal duro soldada prolongará la vida útil de la herramienta y ofrecerá un rendimiento superior al escariar agujeros dentro de los límites de la tolerancia H7. El diseño extremadamente desigual de los canales reduce vibraciones y mejora la redondez del agujero, el acabado superficial y el tamaño. Esta herramienta ofrece un gran rendimiento en máquinas CNC.

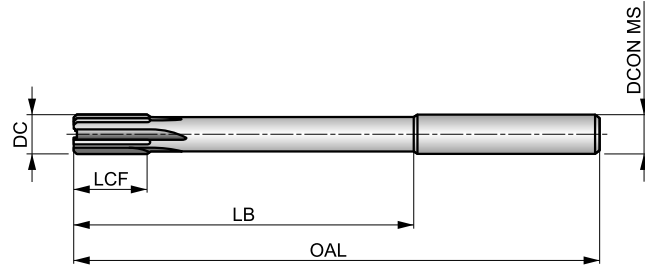

HM	Bright	DIN 8050
R		A
H7		

Grupo de Material de la pieza adecuado y condiciones de velocidad de corte iniciales (m/min) y código de avance alfabético. Tablas con avance por revolución a partir de la pag.279.

P1.1 ■ 23 B	P1.2 ■ 26 B	P1.3 ■ 27 B	P2.1 ■ 20 B	P2.2 ■ 18 B	P2.3 ■ 16 C	P3.1 ■ 16 B	P3.2 ■ 13 B	P3.3 ■ 11 C	P4.1 ■ 10 B	P4.2 ■ 8 C	P4.3 ■ 7 C	M1.1 ▣ 10 C	M1.2 ▣ 8 C
M2.1 ▣ 9 C	M2.2 ▣ 17 C	M2.3 ▣ 16 B	K1.1 ■ 20 D	K1.2 ■ 15 D	K1.3 ■ 11 D	K2.1 ■ 21 D	K2.2 ■ 17 D	K2.3 ■ 14 D	K3.1 ■ 18 D	K3.2 ■ 14 D	K3.3 ■ 11 D	K5.1 ■ 19 D	K5.2 ■ 15 D
K5.3 ■ 11 D	N1.1 ▣ 60 D	N1.2 ■ 45 D	N1.3 ■ 30 D	N2.1 ■ 38 D	N2.2 ■ 35 D	N2.3 ■ 25 D	N3.1 ■ 64 E	N3.2 ■ 38 E	N3.3 ▣ 19 E	N4.1 ▣ 35 C	N4.2 ▣ 30 C		

DCON MS tolerancia h9; con Punta de Metal Duro

Product	DC (mm)	OAL (mm)	LCF (mm)	LB (mm)	NOF	DCON MS (mm)
B44110.0	10.00	133.0	19.0	87.00	6	10.00
B44111.0	11.00	142.0	19.0	96.00	6	10.00
B44112.0	12.00	151.0	19.0	105.00	6	10.00
B44113.0	13.00	151.0	19.0	105.00	6	10.00
B44114.0	14.00	160.0	19.0	110.00	6	12.50
B44115.0	15.00	162.0	19.0	112.00	6	12.50
B44116.0	16.00	170.0	22.0	120.00	6	12.50
B44117.0	17.00	175.0	22.0	123.00	6	14.00
B44118.0	18.00	182.0	22.0	130.00	6	14.00
B44119.0	19.00	189.0	22.0	131.00	6	16.00
B44120.0	20.00	195.0	22.0	137.00	6	16.00

B411



Escariador de Máquina con Punta de Metal Duro, Mango Cónico, Tolerancia H7, Acabado Brillante

La cabeza de metal duro soldada ofrece mejoras significativas en el rendimiento y una vida útil más prolongada de la herramienta al escariar materiales duros y abrasivos. Los canales helicoidales tienen un espaciado desigual entre ellos, lo que reduce eficientemente las vibraciones y mejora la simetría, el tamaño y el acabado del agujero.

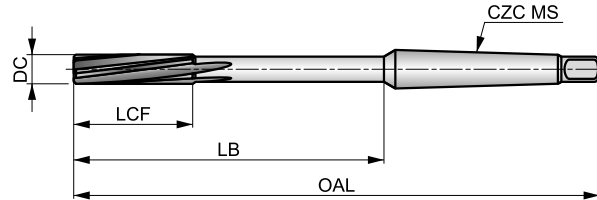

HM	Bright	DIN 8094
R		B
H7		

Grupo de Material de la pieza adecuado y condiciones de velocidad de corte iniciales (m/min) y código de avance alfabético. Tablas con avance por revolución a partir de la pag.279.

P1.1 ■ 23 B	P1.2 ■ 26 B	P1.3 ■ 27 B	P2.1 ■ 20 B	P2.2 ■ 18 B	P2.3 ■ 16 C	P3.1 ■ 16 B	P3.2 ■ 13 B	P3.3 ■ 11 C	P4.1 ■ 10 B	P4.2 ■ 8 C	P4.3 ■ 7 C	M1.1 ▣ 10 C	M1.2 ▣ 8 C
M2.1 ▣ 9 C	M2.2 ▣ 17 C	M2.3 ▣ 16 B	K1.1 ■ 20 D	K1.2 ■ 15 D	K1.3 ■ 11 D	K2.1 ■ 21 D	K2.2 ■ 17 D	K2.3 ■ 14 D	K3.1 ■ 18 D	K3.2 ■ 14 D	K3.3 ■ 11 D	K5.1 ■ 19 D	K5.2 ■ 15 D
K5.3 ■ 11 D	N1.1 ▣ 60 D	N1.2 ■ 45 D	N1.3 ■ 30 D	N2.1 ■ 38 D	N2.2 ■ 35 D	N2.3 ■ 25 D	N3.1 ■ 64 E	N3.2 ■ 38 E	N3.3 ▣ 19 E	N4.1 ▣ 35 C	N4.2 ▣ 30 C		

DC <= 16mm Cabeza de Metal Duro; DC > 16mm con Punta de Metal Duro

Product	DC (mm)	OAL (mm)	LCF (mm)	LB (mm)	NOF	CZC MS
B4115.0	5.00	133.0	23.0	67.50	6	MK 1
B4116.0	6.00	138.0	26.0	72.50	6	MK 1
B4117.0	7.00	150.0	31.0	84.50	6	MK 1
B4118.0	8.00	156.0	33.0	90.50	6	MK 1
B4119.0	9.00	162.0	36.0	96.50	6	MK 1
B41110.0	10.00	168.0	38.0	102.50	6	MK 1
B41112.0	12.00	182.0	44.0	116.50	6	MK 1
B41114.0	14.00	189.0	47.0	123.50	8	MK 1
B41115.0	15.00	204.0	50.0	124.00	8	MK 2
B41116.0	16.00	210.0	52.0	130.00	8	MK 2
B41117.0	17.00	214.0	54.0	134.00	6	MK 2
B41118.0	18.00	219.0	56.0	139.00	6	MK 2
B41119.0	19.00	223.0	58.0	143.00	6	MK 2
B41120.0	20.00	228.0	60.0	148.00	6	MK 2
B41122.0	22.00	237.0	64.0	157.00	6	MK 2
B41124.0	24.00	268.0	68.0	169.00	8	MK 3
B41125.0	25.00	268.0	68.0	169.00	8	MK 3
B41126.0	26.00	273.0	70.0	174.00	8	MK 3
B41130.0	30.00	281.0	73.0	182.00	8	MK 3

B442



Escariador de Máquina, Metal Duro, Mango Cónico, Espacio Desigual, Tolerancia H7, Acabado Brillante
 Diseñado con canales extremadamente desiguales para reducir la vibración y mejorar el tamaño del agujero, la redondez y el acabado superficial. El chaflán de entrada a 45° garantiza una ubicación y un centrado precisos para brindarle un mejor rendimiento y calidad de agujero. La punta de metal duro soldada proporciona una mayor vida útil de la herramienta y un rendimiento superior.

HM	Bright	DIN 8051
R		A
H7		

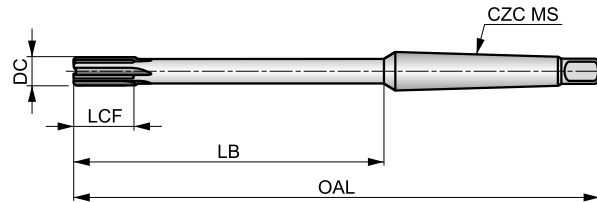

Grupo de Material de la pieza adecuado y condiciones de velocidad de corte iniciales (m/min) y código de avance alfabético. Tablas con avance por revolución a partir de la pag.279.

P1.1 ■ 23 B	P1.2 ■ 26 B	P1.3 ■ 27 B	P2.1 ■ 20 B	P2.2 ■ 18 B	P2.3 ■ 16 C	P3.1 ■ 16 B	P3.2 ■ 13 B	P3.3 ■ 11 C	P4.1 ■ 10 B	P4.2 ■ 8 C	P4.3 ■ 7 C	M1.1 ▣ 10 C	M1.2 ▣ 8 C
M2.1 ▣ 9 C	M2.2 ▣ 7 C	M2.3 ▣ 6 B	K1.1 ■ 20 D	K1.2 ■ 15 D	K1.3 ■ 11 D	K2.1 ■ 21 D	K2.2 ■ 17 D	K2.3 ■ 14 D	K3.1 ■ 18 D	K3.2 ■ 14 D	K3.3 ■ 11 D	K5.1 ■ 19 D	K5.2 ■ 15 D
K5.3 ■ 11 D	N1.1 ▣ 60 D	N1.2 ■ 45 D	N1.3 ■ 30 D	N2.1 ■ 38 D	N2.2 ■ 35 D	N2.3 ■ 25 D	N3.1 ■ 64 E	N3.2 ■ 38 E	N3.3 ▣ 19 E	N4.1 ▣ 35 C	N4.2 ▣ 30 C		

Product	DC (mm)	OAL (mm)	LCF (mm)	LB (mm)	NOF	CZC MS
B44210.0	10.00	168.0	19.0	102.50	6	MK 1
B44212.0	12.00	182.0	19.0	116.50	6	MK 1
B44214.0	14.00	189.0	19.0	123.50	6	MK 1
B44215.0	15.00	204.0	19.0	124.00	6	MK 2
B44216.0	16.00	210.0	22.0	130.00	6	MK 2
B44217.0	17.00	214.0	22.0	134.00	6	MK 2
B44218.0	18.00	219.0	22.0	139.00	6	MK 2
B44219.0	19.00	223.0	22.0	143.00	6	MK 2
B44220.0	20.00	228.0	22.0	148.00	6	MK 2



PMK
NSH



INSTRUCCIONES

BROCAS: PÁGINA RESUMEN

1 R003

DORMER



Broca de metal duro, punta recubierta TiN

Broca básica y versátil con ángulo de punta de 120° y geometría de punta dividida en cuatro facetas para reducir la fuerza de empuje. Tecnología CTW para mejorar la velocidad de taladrado. El recubrimiento TiN de la punta mejora el rendimiento y prolonga la vida útil de la herramienta. Adecuada para máquinas CNC y convencionales en el taladrado de una amplia gama de materiales.

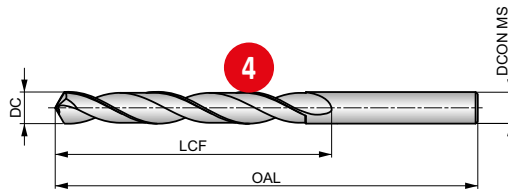

HM	DIN 338	4xD
120°	TiN-Tip	5
λ _{20-35°}	R	DC h7

Grupo de Material de la pieza adecuado y condiciones de velocidad de corte iniciales (m/min) y código de avance alfabético. Tablas con avance por revolución a partir de la pag.274.

P1.1	P1.2	P1.3	P2.1	P2.2	P2.3	P3.1	P3.2	P3.3	P4.1	P4.2	P4.3	K1.1	K1.2
■ 99 S	■ 111 S	■ 115 S	■ 85 S	■ 75 S	■ 66 S	■ 66 S	■ 53 S	■ 45 S	■ 40 S	■ 34 S	■ 27 S	■ 75 T	■ 56 T
K1.3	K2.1	K2.2	K2.3	K3.1	K3.2	K3.3	1.1	K4.2	K4.3	K4.4	K4.5	K5.1	K5.2
■ 42 T	■ 68 T	■ 55 T	■ 44 T	■ 60 T	■ 46 T	■ 37 T	■ 55 T	■ 42 T	■ 31 T	■ 26 T	■ 22 T	■ 63 T	■ 47 T
K5.3	N1.1	N1.2	N1.3	N2.1	N2.2	N2.3	N3.1	N3.2	N4.1	N4.2	H1.1	H2.1	H3.1
■ 37 T	■ 150 V	■ 113 V	■ 75 V	■ 129 V	■ 116 V	■ 84 V	■ 317 V	■ 190 V	■ 60 U	■ 100 U	■ 34 S	■ 20 S	■ 22 S

Product	DC (inch)	DC (mm)	DC (inch)	LCF (mm)	OAL (mm)	DCON MS (mm)
R0031.0	-	1.00	0.0394	12.0	34.0	1.00
R003N60	N60	1.02	0.0400	12.0	34.0	1.02
R0031.1	-	1.10	0.0433	14.0	36.0	1.10
R003N56	N56	1.18	0.0465	16.0	38.0	1.18
R003N54	3/64	1.19	0.0469	16.0	38.0	1.19
R0031.3	-	1.20	0.0472	16.0	38.0	1.20
R0031.3	-	1.30	0.0512	16.0	38.0	1.30
R003N54	N54	1.40	0.0550	18.0	40.0	1.40
R0031.4	-	1.40	0.0551	18.0	40.0	1.40
R0031.5	-	1.50	0.0591	18.0	40.0	1.50
R003N53	N53	1.51	0.0595	20.0	43.0	1.51
R0031/16	1/16	1.59	0.0625	20.0	43.0	1.59
R0031.6	-	1.60	0.0630	20.0	43.0	1.60
R003N52	N52	1.61	0.0635	20.0	43.0	1.61

Product	DC (inch)	DC (mm)	DC (inch)	LCF (mm)	OAL (mm)	DCON MS (mm)
R0032.3	-	2.30	0.0906	27.0	53.0	2.30
R0033/32	3/32	2.38	0.0937	30.0	57.0	2.38
R0032.4	-	2.40	0.0945	30.0	57.0	2.40
R003N41	N41	2.44	0.0960	30.0	57.0	2.44
R0032.5	-	2.50	0.0984	30.0	57.0	2.50
R003N39	N39	2.53	0.0995	30.0	57.0	2.53
R003N38	N38	2.58	0.1015	30.0	57.0	2.58
R0032.6	-	2.60	0.1024	30.0	57.0	2.60
R003N37	N37	2.64	0.1040	30.0	57.0	2.64
R0032.7	-	2.70	0.1063	33.0	61.0	2.70
R003N36	N36	2.71	0.1065	33.0	61.0	2.71
R0037/64	7/64	2.78	0.1094	33.0	61.0	2.78
R0032.8	-	2.80	0.1102	33.0	61.0	2.80
R003N33	N33	2.87	0.1130	33.0	61.0	2.87

Pos.	Descripción
1	Denominación de la broca
2	Descripción del producto
3	Imagen
4	Representación esquemática de la herramienta

Pos.	Descripción
5	Características del producto
6	Recomendaciones de grupos de materiales, incluidas la velocidad de corte y la guía de avance
7	Código de producto
8	Dimensiones del producto

PLAQUITAS DE CORTE: PÁGINA RESUMEN

1 SCET



	IC (mm)	D1 (mm)	L (mm)	S (mm)
0502	5.556	3	5.56	2.38
0602	6.350	2.90	6.35	2.38
0703	7.937	3.50	7.94	3.18
09T3	9.525	4.50	9.53	3.97
1204	12.700	5.60	12.70	4.76
1505	15.875	5.60	15.88	5.56

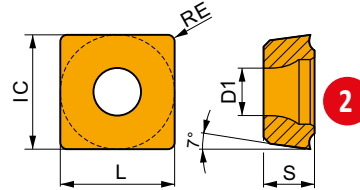

Valores de inicio adecuados para la velocidad de corte (vc), avance (f) y profundidad de corte (ap). Consulte nuestra APP Calculadora de mecanizado para obtener más cálculos.

Product	Intermittent/ Continuous cut	RE (mm)	P			M			K			N			S			H		
			vc (m/min)	f (mm/rev)	ap (mm)	vc (m/min)	f (mm/rev)	ap (mm)	vc (m/min)	f (mm/rev)	ap (mm)	vc (m/min)	f (mm/rev)	ap (mm)	vc (m/min)	f (mm/rev)	ap (mm)	vc (m/min)	f (mm/rev)	ap (mm)



Geometría UD con diseño universal para plaquitas periféricas.

SCET 050204-UD:D8330	● 0.4	■ 165	0.08	—	—	—	—	■ 155	0.08	—	—	—	—	—	—	—	—	—	—
SCET 050204-UD:D9335	● 0.4	■ 240	0.08	—	—	—	—	■ 225	0.08	—	—	—	—	—	—	—	—	—	—
SCET 060204-UD:D8330	● 0.4	■ 165	0.11	—	—	—	—	■ 155	0.11	—	—	—	—	—	—	—	—	—	—
SCET 060204-UD:D9335	● 0.4	■ 240	0.11	—	—	—	—	■ 225	0.11	—	—	—	—	—	—	—	—	—	—
SCET 070308-UD:D8330	● 0.4	■ 165	0.13	—	—	—	—	■ 155	0.13	—	—	—	—	—	—	—	—	—	—
SCET 070308-UD:D9335	● 0.4	■ 240	0.13	—	—	—	—	■ 225	0.13	—	—	—	—	—	—	—	—	—	—
SCET 09T308-UD:D8330	● 0.8	■ 165	0.14	—	—	—	—	■ 155	0.14	—	—	—	—	—	—	—	—	—	—
SCET 09T308-UD:D9335	● 0.8	■ 240	0.14	—	—	—	—	■ 225	0.14	—	—	—	—	—	—	—	—	—	—
SCET 120408-UD:D8330	● 0.8	■ 165	0.16	—	—	—	—	■ 155	0.16	—	—	—	—	—	—	—	—	—	—
SCET 120408-UD:D9335	● 0.8	■ 240	0.16	—	—	—	—	■ 225	0.16	—	—	—	—	—	—	—	—	—	—
SCET 150512-UD:D8330	● 1.2	■ 165	0.18	—	—	—	—	■ 155	0.18	—	—	—	—	—	—	—	—	—	—
SCET 150512-UD:D9335	● 1.2	■ 240	0.18	—	—	—	—	■ 225	0.18	—	—	—	—	—	—	—	—	—	—

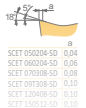

Geometría UD con diseño universal para plaquitas periféricas.

Pos.	Descripción
1	Denominación de la plaquita de corte
2	Representación esquemática de la plaquita de corte
3	Tabla de tamaños de plaquita de corte (mm)
4	Imagen representativa de una plaquita de corte
5	Perfil del filo de corte principal
6	Símbolos: características especiales y tipo de filo de corte

Pos.	Descripción
7	Código ISO para la plaquita de corte: Calidad
8	Condiciones de trabajo
9	Radios de plaquita de corte (mm)
10	Descripción de la geometría
11	Área de aplicación de la plaquita de corte

BROCAS DE PLAQUITA INTERCAMBIABLE: PÁGINA RESUMEN

1
2
P
M
K
N
S
H
PRAMET
S
3



Cuerpo de Broca 802D de placa intercambiable 2XD con Refrigeración Interna
 Cuerpo de broca de plaquitas intercambiables de alto rendimiento para taladrar agujeros ciegos y pasantes. Potencialmente también taladrado de agujeros cruzados, descentrados y en paquetes de chapas, interpolación helicoidal, fresado axial (plunge), taladrado en superficies cóncavas o en ángulo, taladrado con cortes interrumpidos, achaflanado y mandrinado. Disponible desde Ø15 hasta Ø40 mm en 2xD.

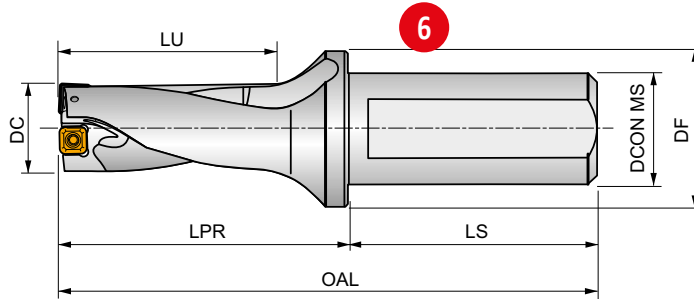

2xD
1
ISO 9766
7



Product	DC	APMX	OAL	LPR	LS	LU	DCON MS	DF	D ⁻	D ⁺	EP	GI300	GI313	0.30	HM001
	[mm]	[mm]	[mm]	[mm]	[mm]	[mm]	[mm]	[mm]	[mm]	[mm]	[mm]				
802D-15-30-S25	15	30.00	121	65	56	34.5	25	35	0.25	0.35	EP253253	GI300	GI313	0.30	HM001
802D-16-32-S25	16	32.00	123	67	56	37	25	35	0.15	0.45	EP253253	GI300	GI313	0.30	HM001
802D-17-34-S25	17	34.00	125	69	56	39.5	25	35	0.15	0.50	EP253253	GI301	GI314	0.31	HM002
802D-18-36-S25	18	36.00	127	71	56	42	25	35	0.35	0.25	EP253253	GI301	GI314	0.31	HM002
802D-19-38-S25	19	38.00	129	73	56	44.5	25	35	0.15	0.45	EP253253	GI301	GI314	0.32	HM002
802D-20-40-S25	20	40.00	131	75	56	47	25	35	0.10	0.45	EP253253	GI302	GI315	0.33	HM003
802D-21-42-S25	21	42.00	133	77	56	49.5	25	35	0.10	0.50	EP253253	GI302	GI315	0.34	HM003
802D-22-44-S25	22	44.00	135	79	56	52	25	35	0.45	0.50	EP253253	GI303	GI316	0.35	HM004
802D-23-46-S25	23	46.00	137	81	56	54.5	25	35	0.35	0.50	EP253253	GI304	GI317	0.36	HM005
802D-24-48-S25	24	48.00	139	83	56	57	25	35	0.15	0.50	EP253253	GI304	GI317	0.37	HM005

Product	APMX	DCON MS
GI300	XPET 0502AP	SCET 050204-UD
GI301	XPET 0602AP	SCET 050204-UD
GI302	XPET 0602AP	SCET 060204-UD
GI303	XPET 0703AP	SCET 060204-UD
GI304	XPET 0703AP	SCET 070308-UD
GI305	XPET 0903AP	SCET 070308-UD
GI306	XPET 0903AP	SCET 09T308-UD
GI307	XPET 11T3AP	SCET 09T308-UD
GI308	XPET 11T3AP	SCET 120408-UD
GI309	XPET 12T3AP	SCET 120408-UD
GI313	XPET 0502AP-SD	SCET 050204-SD
GI314	XPET 0602AP-SD	SCET 050204-SD
GI315	XPET 0602AP-SD	SCET 060204-SD
GI316	XPET 0703AP-SD	SCET 060204-SD
GI317	XPET 0703AP-SD	SCET 070308-SD

Product	APMX	DCON MS
GI300	XPET 0502AP	SCET 050204-UD
GI301	XPET 0602AP	SCET 050204-UD
GI302	XPET 0602AP	SCET 060204-UD
GI303	XPET 0703AP	SCET 060204-UD
GI304	XPET 0703AP	SCET 070308-UD

**BROCAS DE PLAQUITA INTERCAMBIABLE: PÁGINA RESUMEN**

Pos.	Descripción	Pos.	Descripción
1	Denominación de la broca	11	Ajuste radial (mm)
2	Recomendaciones de grupo de material	12	Manguito ajustable
3	Sistema de fijación de la plaquita de corte	13	Grupo de plaquitas de corte compatibles con rompevirutas UD ^{1),2)}
4	Descripción de la herramienta	14	Grupo de plaquitas de corte compatibles con rompevirutas SD ^{1),2)}
5	Imagen	15	Peso (kg)
6	Representación esquemática de la herramienta	16	Grupo de piezas de repuesto ¹⁾
7	Características del producto	17	Plaquitas de corte compatibles con rompevirutas UD
8	Aplicaciones del producto	18	Plaquitas de corte compatibles con rompevirutas SD
9	Código de la herramienta	19	Piezas de repuesto
10	Dimensiones de la herramienta		

¹⁾ El código de grupo de plaquitas de corte compatibles y piezas de repuesto se utiliza únicamente con fines de guía dentro de este catálogo. No se puede utilizar para pedidos.

²⁾ Las plaquitas de corte externas (SCET) e internas (XPET) deben tener siempre el mismo rompevirutas (AVISO: El rompevirutas UD no está visiblemente incluido en la denominación de las plaquitas de corte XPET, p. ej. XPET 0502AP); la información necesaria para la correcta elección del rompevirutas (UD o SD) se puede encontrar en el embalaje de la plaquita de corte.

RESUMEN DE SÍMBOLOS

Símbolos generales

<input type="checkbox"/>	Uso principal	<input checked="" type="checkbox"/>	Uso posible
--------------------------	---------------	-------------------------------------	-------------

Grupo básico de Normas (BSG)





DIN 1897	DIN 1897 - Normas sobre brocas extracortas	DIN 6539	DIN 6539	DIN 212	DIN 212 - Normas sobre escariadores de máquina
DIN 1899	DIN 1899 - Normas sobre microbrocas	DIN 6537K	DIN 6537 K	DIN 2179	DIN 2179 - Normas sobre escariadores para pasadores cónicos con mango paralelo
DIN 338	DIN 338 - Normas sobre brocas de mango recto	DIN 6537L	DIN 6537 L	DIN 2180	DIN 2180 - Normas sobre escariadores para pasadores cónicos con mango cónico Morse
NAS 907	NAS907 - Normas sobre brocas para aplicaciones aeroespaciales	DIN 333R	DIN 333R - Normas sobre avellanadores de mango recto	DIN 311	DIN 311 - Normas sobre escariadores guiados con mango cónico Morse
DIN 340	DIN 340 - Normas sobre brocas de longitud cónica	DIN 334C	DIN 334 C - Normas sobre avellanadores con mango recto	DIN 8050	DIN 8050 - Normas sobre escariadores con mango paralelo
DIN 1869-1	DIN 1869 / 1 - Normas sobre brocas extralargas con mango recto	DIN 335A	DIN 335 A - Normas sobre avellanadores con mango recto	DIN 8051	DIN 8051 - Normas sobre escariadores con mango cónico Morse
DIN 1869-2	DIN 1869 / 2 - Normas sobre brocas extralargas con mango recto	DIN 335C	DIN 335 C - Normas sobre avellanadores con mango recto	DIN 8093	DIN 8093 - Normas sobre escariadores con mango recto
DIN 1869-3	DIN 1869 / Avellanador de 60-100° - Normas sobre brocas extralargas con mango recto	DIN 334D	DIN 334 D - Normas sobre avellanadores con mango cónico Morse	DIN 8094	DIN 8094 - Normas sobre escariadores con mango cónico Morse
DIN 1870(2)	DIN 1870 (2) - Normas sobre brocas extralargas con mango cónico Morse	DIN 335D	DIN 335 D - Normas sobre avellanadores con mango cónico Morse	DIN 9	DIN Avance (mm/rev) - Normas sobre escariadores para pasadores cónicos
DIN 345	DIN 345 - Normas sobre brocas de mango cónico Morse	DIN 373	DIN 373 - Normas sobre escariado	DIN ANSI	Normas DIN/ANSI
DIN 8374	DIN 8374 - Normas sobre brocas bidiametrales	BS 328	BS 328 - Normas sobre brocas y escariadores	ANSI	ANSI – Norma sobre machos de roscar
DIN 8376	DIN 8376 - Normas sobre brocas escalonadas	DIN 206	DIN 206 - Normas sobre escariadores manuales	DORMER	Normas Dormer
DIN 333A	DIN 333A - Normas sobre brocas de centrar	DIN 208	DIN 208 - Normas sobre escariadores con mango cónico Morse		

Longitud Útil (ULDR)

1xD	Relación entre profundidad de la herramienta y diámetro útil 1xD	3.5xD	Relación entre profundidad de la herramienta y diámetro útil Avellanador de 60-100°.5xD	12xD	Relación entre profundidad de la herramienta y diámetro útil 12xD
1.25xD	Relación entre profundidad de la herramienta y diámetro útil 1,25xD	4xD	Relación entre profundidad de la herramienta y diámetro útil 4xD	15xD	Relación entre profundidad de la herramienta y diámetro útil 15xD
1.5xD	Relación entre profundidad de la herramienta y diámetro útil 1,5xD	5xD	Relación entre profundidad de la herramienta y diámetro útil 5xD	20xD	Relación entre profundidad de la herramienta y diámetro útil 20xD
2xD	Relación entre profundidad de la herramienta y diámetro útil 2xD	6xD	Relación entre profundidad de la herramienta y diámetro útil 6xD	25xD	Relación entre profundidad de la herramienta y diámetro útil 25xD
2.5xD	Relación entre profundidad de la herramienta y diámetro útil 2,5xD	8xD	Relación entre profundidad de la herramienta y diámetro útil 8xD		
3xD	Relación entre profundidad de la herramienta y diámetro útil 3xD	10xD	Relación entre profundidad de la herramienta y diámetro útil 10xD		

RESUMEN DE SÍMBOLOS





Ángulo de aplicación

 118°	Punta de la broca 118°	 120°	Punta de la broca de puntear 120°	 82°	Avellanador de 82°
 120°	Punta de la broca 120°	 150°	Punta de la broca de puntear 150°	 90°	Avellanador de 90°
 122°	Punta de la broca 122°	 90°	Pretaladrado con chaffan a 90° (para roscado con macho)	 100°	Avellanador de 100°
 130°	Punta de la broca 130°	 90°	Taladrado escalonado (para elementos de fijacion), escariado a 90°	 60-100°	Avellanador de 60-100°
 135°	Punta de la broca 135°	 180°	Taladrado escalonado (para elementos de fijacion), escariado a 180°	 60°	Broca de centrar avellanada a 60°
 140°	Punta de la broca 140°	 180°	Escariado de 180°	 R	Radio de avellanado broca de centrar
 90°	Punta de la broca de puntear 90°	 20°	Broca cónica de 20°		
 90°/120°	Punta de la broca de puntear a 90°/120°	 60°	Avellanador de 60°		

Mango

 Mango cilíndrico/mango recto	 Mango cilíndrico con cara cuadrada	 ISO 9766	Mango universal
 DIN 6535 HA	 Mango cilíndrico con cara hexagonal		Mango cilíndrico con ala
 Mango cilíndrico con espiga	 Mango cónico Morse	 ISO 9766	ISO 9766 - Mango cilíndrico (con o sin cara plana)
 Mango cilíndrico con tres caras planas	 Mango cilíndrico reducido	 DIN 6535 HB DIN 6535 HE	DIN 6535 - Mango HB (Weldon) o HE (Whistle Notch)

Forma de la Hélice





 CTW	Diseno con alma continuamente adelgazada	 λ > 35°	Diseno de canal helicoidal de evacuacion rapida	 λ 20-35°	Diseno de canal helicoidal de evacuacion estandar
 λ 32-40°	Diseno de canal helicoidal de evacuacion rapida	 VA	Afilado especial		

Mano (dirección de corte)

 L	Giro/corte a la izquierda	 R	Giro/corte a la derecha		Refrigeración interna
--	---------------------------	---	-------------------------	---	-----------------------

Refrigeración (CSP)

Clase de tolerancia del diámetro de corte (TCDC)

 DC h6	h6 - Clase de tolerancia de la herramienta estándar en la industria (en función del margen de diámetros)	 DC h8	h8 - Clase de tolerancia de la herramienta estándar en la industria (en función del margen de diámetros)
 DC h7	h7 - Clase de tolerancia de la herramienta estándar en la industria (en función del margen de diámetros)	 DC m7	m7 - Clase de tolerancia de la herramienta estándar en la industria (en función del margen de diámetros)

RESUMEN DE SÍMBOLOS

Tolerancia del agujero alcanzable (TCHA)

H7	H7 - Clase de tolerancia de agujero estándar en la industria (en función del margen de diámetros)	k11	k11 - Clase de tolerancia de la herramienta estándar en la industria (en función del margen de diámetros)		Clase de tolerancia de agujero de alta precisión (en función del margen de diámetros)
-----------	---	------------	---	---	---



















Forma del Escariador

A	DIN Forma A - Canal recto $\leq \emptyset 3$, Características de la plaquita de corte mm	B	DIN Forma B - Canal helicoidal $\leq \emptyset 3$, Características de la plaquita de corte mm
----------	---	----------	--

Gradiente cónico (tasa de cónico) (tasa de cónico) - milímetros (TG)

1:50	Gradiente de conicidad (conicidad de 1 mm por 50 mm)	1:48	Gradiente de conicidad (conicidad de 1/Operaciones de taladrado" por pie)
-------------	--	-------------	---

Operaciones de taladrado

	Taladrado de agujeros ciegos		Taladrado de materiales apilados		Mandrilado
	Taladrado de agujeros pasantes		Taladrado de interpolación helicoidal		Mandrinado de agujeros ciegos
	Taladrado en una superficie inclinada		Taladrado de uniones soldadas		Mandrilado de agujeros pasantes
	Taladrado en una superficie curva		Corte interrumpido		Mandrilado de interpolación helicoidal
	Salida de broca en superficie inclinada		Achaflanado (biselado)		Mandrilado hasta una escuadra
	Taladrado a través de un agujero existente		Achaflanado (biselado) en agujero		Mandrilado a través de agujeros transversales



Características de la plaquita de corte

	Para materiales difíciles de mecanizar (viruta larga)		Opción universal
	Condiciones de trabajo pesadas		Filo redondeado con faceta

Características generales de las herramientas

	1 diente efectivo por revolución		Diseño monobloque		Posibilidad de uso para mecanizado excéntrico
--	----------------------------------	---	-------------------	---	---

Otros símbolos

	Par de apriete del tornillo (Nm)	S	S - Tornillo de sujeción a través del agujero		Avance (mm/rev)
--	----------------------------------	----------	---	---	-----------------

PLAQUITAS – DESIGNACIÓN CÓDIGO ISO

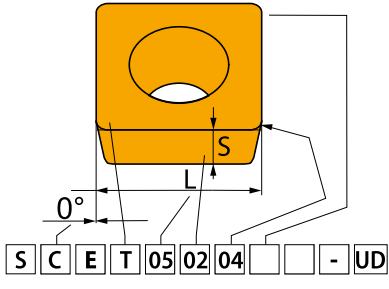

ISO	1	2	3	4
	S	C	E	T
ANSI	1	2	3	4
	S	C	E	T

1				2				4			
Forma de plaquita				Ángulo de incidencia				Tipo de plaquita			
H 	O 	P 	R 	A 	B 	N 		F 	A 	M 	G
S 	T 	C 	D 	C 	D 	W 	T 	E 	F 	Q 	U
E 	M 	V 	W 	G 	N 	B 	H 	L 	A 	B 	C
L 	A 	B 	K 	P 	O Especial	J 	X Especial				

3				3			
Tolerancias							
	(mm)			(")			
	M(±)	S(±)	IC(±)	M(±)	S(±)	IC(±)	
A	0.005	0.025	0.025	.0002"	.001"	.0010"	
F	0.005	0.025	0.013	.0002"	.001"	.0005"	
C	0.013	0.025	0.025	.0005"	.001"	.0010"	
H	0.013	0.025	0.013	.0005"	.001"	.0005"	
E	0.025	0.025	0.025	.0010"	.001"	.0010"	
G	0.025	0.130	0.025	.0010"	.005"	.0010"	
J	0.005	0.025	0.05 – 0.13	.0002"	.001"	.002 – 0.005"	
K	0.013	0.025	0.05 – 0.13	.0005"	.001"	.002 – 0.005"	
L	0.025	0.025	0.05 – 0.13	.0010"	.001"	.002 – 0.005"	
M	0.08 – 0.18	0.130	0.05 – 0.13	.003 – 0.007"	.005"	.002 – 0.005"	
N	0.08 – 0.18	0.025	0.05 – 0.13	.003 – 0.007"	.001"	.002 – 0.005"	
U	0.05 – 0.38	0.130	0.05 – 0.13	.005 – 0.015"	.005"	.003 – 0.010"	

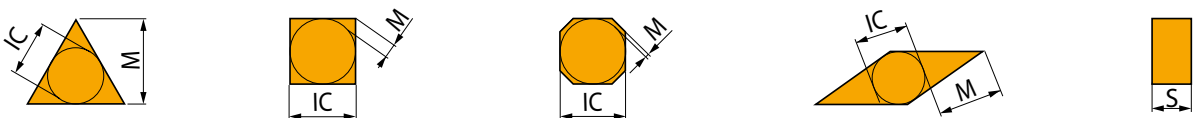

PLAQUITAS – DESIGNACIÓN CÓDIGO ISO

5	6	7	8	9	10
05	02	04			UD
5	6	7	8	9	10
1.8	1.5	1			UD

5												5												6			7		
Longitud del filo de corte (tamaño de plaquita)																								Espesor			Radio de punta		
d=IC		H	O	P	S	T	C	D	E	M	V	W	R	K	S		RE												
(mm)	(in)													(mm)	(in)	(mm)	(in)	(mm)	(in)										
3.97					03	06		04				06	02						00	0	0"								
4.76	5/32"				04	08	04	05	04	04	08	L3						02	0.2	1/128"									
5.56	3/16"				05	09	05	06	05	05	09	03						04	0.4	1/64"									
6.35	7/32"	03	02	04	08	11	06	07	08	08	11	04	06					08	0.8	1/32"									
7.94	1/4"	04	03	05	07	13	08	09	06	07	13	05	07					12	1.2	3/64"									
9.525	5/16"	05	04	07	09	16	09	11	09	09	16	06	09	16				16	1.6	1/16"									
12.7	3/8"	07	05	09	12	22	12	15	13	12	22	08	12					24	2.4	3/32"									
15.875	1/2"	09	06	11	15	27	16	19	16	15	27	10	15					32	3.2	1/8"									
19.05	5/8"	11	07	13	19	33	19	23	19	19	33	13	19					Plaquitas redondas											
25.40	3/4"	14	10	18	25	44	25	31	26	25	44	17	25					d=I.C.											
31.75	1"	18	13	23	31	54	32	38	32	31	54	21	31					(")	00										
	1 1/4"																	(mm)	M0										

ANSI											
5			6			7					
Círculo inscrito			Espesor			Radio de punta					
Symbol			Symbol			Symbol			Symbol		
d=I.C.			S			RE					
	(mm)	(")		(mm)	(")		(mm)	(")		(mm)	(")
1	3.175	1/8"	1	1.588	1/16"	0	0	0"	0.2	0.099	1/256"
1.2	3.969	5/32"	1.2	1.984	5/64"	0.2	0.198	1/128"	0.5	0.198	1/128"
1.5	4.763	3/16"	1.5	2.381	3/32"	1	0.397	1/64"	2	0.794	1/32"
1.8	5.556	7/32"	2	3.175	1/8"	3	1.191	3/64"	3	1.191	3/64"
2	6.350	1/4"	2.5	3.969	5/32"	4	1.588	1/16"	4	1.588	1/16"
2.5	7.938	5/16"	3	4.763	3/16"	5	1.984	5/64"	5	1.984	5/64"
3	9.525	3/8"	3.5	5.556	7/32"	6	2.381	3/32"	6	2.381	3/32"
4	12.700	1/2"	4	6.350	1/4"	7	2.778	7/64"	7	2.778	7/64"
5	15.875	5/8"	5	7.938	5/16"	8	3.175	1/8"	8	3.175	1/8"
6	19.050	3/4"	6	9.525	3/8"	10	3.969	5/32"	10	3.969	5/32"
7	22.225	7/8"	7	11.113	7/16"	12	4.763	3/16"	12	4.763	3/16"
8	25.400	1"	8	12.700	1/2"	14	5.556	7/32"	14	5.556	7/32"
10	31.750	5/4"	9	14.288	9/16"	16	6.350	1/4"	16	6.350	1/4"
12	38.100	6/4"	10	15.875	5/8"						

8												8		
Condición del filo de corte														
Filos vivos						Filos redondeados								
Filos con faceta						Filo redondeado con faceta								
Filos con doble faceta						Filos redondeados con doble faceta								
9												9		
Dirección de avance														
Avance						Avance						Avance		
10												10		
Designación del rompevirutas														

MARCADO DE LAS BROCAS

1	2	3		4		5		6	7
8	05	D	-	19	-	95	-	S	25



1		2		3		4	
Tipo de herramienta		Longitud aproximada		Variante		Diámetro de corte	
8	Broca intercambiable	02	2 × DC	D	Broca	15.5	DC = 15.5 mm
		03	3 × DC				19
		04	4 × DC				
		05	5 × DC				

5		6		7	
Profundidad de taladrado máx.		Tipo de mango		Diámetro del mango	
35	35 mm	E	Whistle Notch	25	D CON MS = 25 mm
95	95 mm			32	D CON MS = 32 mm
140	140 mm	S	ISO 9766	40	D CON MS = 40 mm

PARÁMETROS DE HERRAMIENTAS DE CORTE SEGÚN ISO 13399

Todas las herramientas de corte están definidas por una serie de parámetros según la norma ISO 13399. Esta lista contiene todos los parámetros utilizados en este catálogo y sus definiciones.

ISO 13399 es una norma internacional de información sobre herramientas de corte. Proporciona dimensiones y parámetros en un formato neutro que es independiente de cualquier sistema particular o nomenclatura de empresa. Cuando las herramientas de corte están claramente definidas de acuerdo con un estándar global, todos los tipos de software pueden procesar los datos electrónicos más rápidamente, mejorando la calidad de la comunicación y ayudando a que el intercambio de información se realice sin problemas. Admitir un

lenguaje común en nuestras descripciones de herramientas de corte ayudará a la comunicación entre sistemas. Le ahorrará una cantidad significativa de tiempo, proporcionando una recopilación más fácil de datos de alta calidad en nuestras 40.000 herramientas integrales e intercambiables. Al utilizar un sistema compatible con ISO 13399, no habrá necesidad de interpretar manualmente los datos e ingresarlos con una clave en su sistema.

Ejemplos

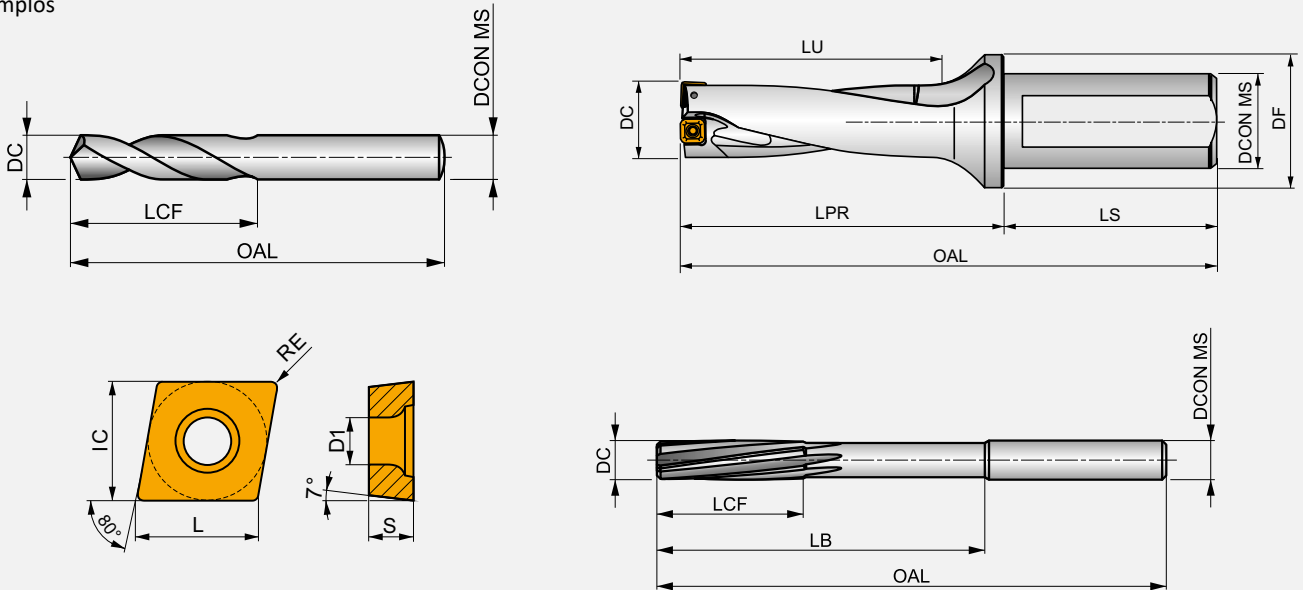





ISO 13399	Descripción
BD	Diámetro del cuerpo
BDX	Diámetro del cuerpo máximo
CZC MS	Código de tamaño de conexión del lado de la máquina
D1	Diámetro del agujero de fijación
DC	Diámetro de corte
DCN	Diámetro de corte mínimo
DCON MS	Diámetro de conexión del lado de la máquina
DCON WS	Diámetro de conexión del lado de la pieza
DCX	Diámetro de corte máximo
DHUB	Diámetro de apoyo
FLGT	Espesor de ala
IC	Diámetro de la circunferencia inscrita
L	Longitud del filo de corte
LB	Longitud del cuerpo
LF	Longitud funcional
LPR	Longitud del saliente
LU	Longitud útil
OAL	Longitud total
RE	Radio angular
S	Espesor de la plaquita de corte
WF	Ancho funcional
APMX	Profundidad de corte máxima
D1	Diámetro del agujero de fijación
DC_1	Diámetro del primer paso de corte
DC_2	Diámetro del segundo paso de corte







ISO 13399	Descripción
DF	Diámetro del ala
DH	Diámetro del cabezal
GPD	Diámetro del piloto guía
GPL	Longitud del piloto guía
H	Altura del mango
HSD	Tamaño de la parte de accionamiento
IC	Diámetro de la circunferencia inscrita
LCF	Longitud del canal de virutas
LCOL	Longitud de la pinza
LDC	Distancia punto de referencia PK
LH	Longitud del cabezal
LS	Longitud del mango
LSC	Longitud de sujeción
NOF	Número de canales
PLGL	Longitud de la punta semicónica
RCSK	Radio del avellanador
RE	Radio angular
SDI	Incrementos del diámetro de paso
SDL	Longitud del diámetro de paso
SDL_1	Longitud del diámetro de paso del primer paso de corte
SDL_2	Longitud del diámetro de paso del segundo paso de corte
TDZ	Tamaño del diámetro de rosca
THLGTH	Longitud de rosca
WSC	Ancho de fijación

NAVEGADOR DE MATERIALES DE HERRAMIENTA





Materiales de herramientas

Acero rápido		Se trata de un acero rápido de aleación media que presenta una buena maquinabilidad y un excelente rendimiento. El HSS presenta características de dureza, tenacidad y resistencia al desgaste que lo hacen atractivo en una amplia variedad de aplicaciones, por ejemplo en brocas y machos de roscar.
Acero rápido al cobalto		Este acero rápido contiene cobalto para aumentar la dureza en caliente. La composición del HSSCo proporciona una buena combinación de tenacidad y dureza. Posee una buena maquinabilidad y una elevada resistencia al desgaste, lo que lo hace apropiado para brocas, machos de roscar, fresas y escariadores.
Metal duro y High Speed Steel		Los materiales mixtos de metal duro y acero rápido suelen unirse con una aleación de soldadura fuerte a alta temperatura que actúa a modo de interfaz. Esta combinación soldada de materiales de herramientas ofrece una sección de corte de metal duro que proporciona una alta resistencia a la compresión, dureza y resistencia al desgaste, unida a un cuerpo de acero rápido que confiere resistencia a la flexión y tenacidad en el cuerpo de la herramienta.
Materiales de metal duro (o materiales duros)		Un sustrato pulvimetalúrgico sinterizado, formado por un compuesto de carburo metálico con metal aglutinante. La materia prima más importante es el carburo de tungsteno (WC). El carburo de tungsteno contribuye al endurecimiento del material. El carburo de tántalo (TaC), el carburo de titanio (TiC) y el carburo de niobio (NbC) complementan al WC y adaptan sus propiedades según se desee. Estos tres materiales se conocen como carburos cúbicos. El cobalto (Co) actúa como aglutinante y mantiene el material unido. Los materiales de carburo suelen caracterizarse por su alta resistencia a la compresión, su elevada dureza y, por tanto, su alta resistencia al desgaste, pero también por su limitada resistencia a la flexión y por su tenacidad. El carburo se utiliza en machos de roscar, escariadores, fresas, brocas y fresas de roscar.

Tratamientos superficiales

Brillante (sin recubrimiento)		El acabado brillante (superficie sin recubrimiento) mejora el flujo de virutas en materiales suaves o materiales no féreos, plásticos y materiales compuestos, a la vez que mantiene afilados los filos de corte.
Niquelado brillante		La superficie niquelada brillante protege el cuerpo de acero endurecido de la oxidación, la corrosión y también mejora la evacuación de las virutas.
Combinación de brillante y templado al vapor		La combinación del recubrimiento brillante y el tratamiento de templado al vapor puede ser eficaz, ya que la superficie de óxido azul —más porosa— actúa para retener y guiar el fluido de corte hacia el interior del agujero, mientras que la superficie brillante ayuda a la evacuación de la viruta. Esta combinación se consigue rectificando la superficie brillante después del proceso de templado.
Tratamiento de templado al vapor		El templado al vapor proporciona una superficie de óxido azul fuertemente adherida que permite retener el fluido de corte y evitar que la viruta se suelde con la herramienta, lo cual contrarresta la formación de un filo de aportación. El templado al vapor puede aplicarse a cualquier herramienta brillante, pero es más eficaz en brocas y machos de roscar.
Templado de bronce		El templado de bronce crea una fina y suave capa de óxido de bronce en la superficie de la herramienta. Al igual que el templado al vapor, ayuda a evitar la soldadura de la viruta con la herramienta y favorece la evacuación de la viruta. El templado de bronce puede aplicarse a cualquier herramienta brillante y también puede combinarse con el templado al vapor en algunas herramientas.
Tratamiento de la superficie con una combinación de vapor y bronce templado		La combinación de vapor y templado de bronce puede ser eficaz, ya que la superficie de óxido azul —más porosa— actúa para retener y guiar el fluido de corte hacia el interior del agujero, mientras que la superficie de bronce ayuda a la evacuación de la viruta. Ambos tratamientos de la superficie añaden un grado de protección a la superficie de la herramienta. Estas combinaciones se consiguen utilizando dos ciclos de templado diferentes.

Recubrimientos superficiales

Brillante y TiN (recubrimiento de la punta) Nitruro de titanio (TiN)		El nitruro de titanio es un recubrimiento cerámico de color dorado que se aplica por deposición física de vapor (PVD). La alta dureza, combinada con las propiedades de baja fricción, garantizan una vida útil más larga de la herramienta y/o un mejor rendimiento de corte de las herramientas que no están recubiertas.
Recubrimientos de nitruro de titanio Recubrimientos de nitruro (TiAlN, TiAlN-Top y X-CEED)		El nitruro de aluminio y titanio es un recubrimiento cerámico multicapa aplicado mediante la tecnología de recubrimiento PVD, que presenta una gran tenacidad y estabilidad a la oxidación. Estas propiedades lo convierten en ideal para alcanzar velocidades y avances más rápidos, al tiempo que mejora la vida útil de la herramienta. El TiAlN se utiliza en aplicaciones de taladrado, roscado con macho y fresado y es apropiado para el mecanizado sin refrigerante. El recubrimiento TiAlN-Top es el mismo que el TiAlN, pero con un proceso posterior al recubrimiento diseñado para suavizar las imperfecciones, mejorar el flujo de la viruta y reducir la formación de filos de aportación.
Ti-phon (TiAlCrSiN)		El recubrimiento Ti-phon es un recubrimiento similar al de TiAlN, pero con la adición de cromo (Cr) y silicio (Si) especialmente formulados para los cabezales Hydra, a fin de evitar la formación de filos de aportación y mejorar en gran medida la evacuación de las virutas. Este recubrimiento presenta una alta dureza en caliente, una gran resistencia a la oxidación y una lubricidad superior cuando se utiliza en herramientas para aplicaciones de mecanizado que implican fuertes tensiones mecánicas y térmicas, altas velocidades y altos avances. Estas propiedades del recubrimiento se traducen en una resistencia al desgaste y una fuerza del filo superiores.
Carbonitruro de titanio-aluminio (AlTiCN)		El carbonitruro de titanio-aluminio (AlTiCN) es un recubrimiento de PVD diseñado específicamente para cumplir los rigurosos requisitos de la industria de los dispositivos médicos. Sin embargo, se puede utilizar también para determinadas operaciones de corte gracias a una tecnología de película fina de alta calidad, con excelentes características de microdureza y adherencia.

CALIDADES DE TALADRADO

Identificación de la calidad	Área de aplicación	Aplicación	Avance	Velocidad de corte	Resistencia a condiciones de trabajo adversas	Recubrimiento	Color	Sustrato	Ventajas del refrigerante	Descripción de la calidad
D9335	P20 - P35	■				MT-CVD	■	FGM	+++	Esta calidad se recomienda para plaquitas de corte periféricas en brocas de plaquita intercambiable; es más adecuada para velocidades de corte y avances elevados.
	M15 - M30	■	▴	▴	▴					
	K15 - K35	■	▴	▴	▴					
	S10 - S20	▣								
D8330	P20 - P35	■				PVD	■	submicron H	+++	Se trata de una calidad universal para la plaquita de corte periférica en brocas de plaquita intercambiable; se puede utilizar en la mayoría de materiales y destaca por su fiabilidad de funcionamiento.
	M15 - M30	■	▴	▴	▴					
	K15 - K35	■	▴	▴	▴					
	S10 - S20	▣								
D8345	P30 - P50	■				PVD	■	submicron H	+++	Se trata de una calidad universal para la plaquita de corte central en brocas de plaquita intercambiable; es extremadamente resistente, por lo que es válida para la mayoría de materiales existentes.
	M20 - M40	■	▴	▴	▴					
	K30 - K40	■	▴	▴	▴					
	S20 - S30	▣								

Sustrato

submicron H	Sustrato de base WC-Co de grano fino (< 1 µm)
FGM	Sustrato de grado funcional

Recubrimiento

MT-CVD	Método de recubrimiento químico a media temperatura
PVD	Método de recubrimiento físico

Ventajas del refrigerante

+++	Uso esencial de refrigerante
-----	------------------------------

BROCAS DE METAL DURO Y HSS: INFORMACIÓN TÉCNICA

Nomenclatura de la broca

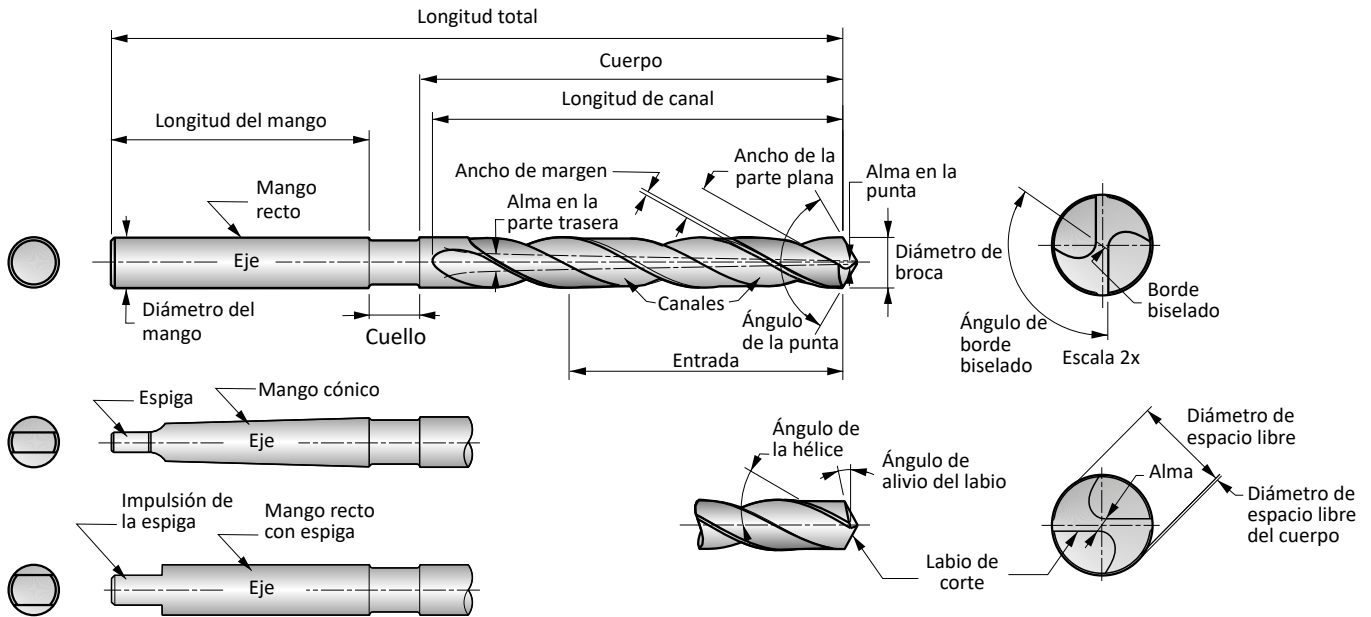

- **Eje:** línea recta imaginaria que forma la línea central longitudinal de una broca.
- **Chaflán de salida:** una ligera disminución del diámetro desde la parte delantera a la trasera en el cuerpo de una broca.
- **Cuerpo:** la parte de una broca que va desde el mango o cuello hasta las esquinas exteriores de los labios de corte.
- **Diámetro de espacio libre del cuerpo:** parte de la parte plana que se ha cortado para que no se adhiera a las paredes del agujero.
- **Borde biselado:** borde al final del alma que conecta los labios de corte.
- **Ángulo del borde biselado:** el ángulo entre el borde biselado y el labio de corte, visto desde el extremo de una broca.
- **Diámetro de espacio libre:** el diámetro sobre la parte cortada de las partes planas de la broca.
- **Broca:** herramienta de corte de extremo giratorio que tiene uno o más labios de corte, y que cuenta con uno o más canales helicoidales o rectos para el paso de las virutas y la entrada de un fluido de corte.
- **Diámetro de broca:** diámetro sobre los márgenes de una broca medido en la punta.
- **Longitud de canal:** longitud desde las esquinas exteriores de los labios de corte hasta el extremo posterior de los canales. Incluye el barrido de la herramienta utilizada para generar los canales y, por lo tanto, no indica la longitud útil de los canales.
- **Canales:** ranuras rectas o helicoidales cortadas o formadas en el cuerpo de una broca para obtener labios de corte, permitir la eliminación de virutas y facilitar el acceso del fluido de corte a los labios de corte.
- **Ángulo de la hélice:** ángulo formado por el borde de entrada de la parte plana con un plano que contiene el eje de una broca.
- **Parte plana:** la parte periférica del cuerpo entre canales adyacentes.
- **Ancho de la parte plana:** distancia entre el borde de entrada y el talón de la parte plana medida en ángulo recto al borde de entrada.
- **Entrada:** avance axial de un borde de entrada de la parte plana en una vuelta alrededor de la circunferencia.
- **Ángulo de alivio del labio:** ángulo de alivio axial en la esquina exterior del labio medido por proyección a un plano tangente a la periferia en la esquina exterior del labio.
- **Labios:** los filos de corte de una broca de dos canales que van desde el borde biselado hasta la periferia.
- **Margen:** parte cilíndrica de la parte plana que no se corta para ofrecer espacio libre.
- **Cuello:** sección de diámetro reducido entre el cuerpo y el mango de una broca.
- **Longitud total:** longitud desde el extremo del mango hasta las esquinas exteriores del labio de corte. No incluye el extremo de mango cónico que se suele utilizar en las brocas de mango recto, ni la punta de corte cónica que se utiliza en las brocas de mango recto y cónico.
- **Punta:** extremo de corte de una broca formado por los extremos de las partes planas y el alma. Su forma es similar a la de un cono, pero difiere de la de un verdadero cono para proporcionar un espacio libre detrás de los labios de corte.
- **Convencionales:** las puntas convencionales con ángulos de punta incluidos de 118° son las más utilizadas, ya que proporcionan resultados satisfactorios en una amplia variedad de materiales. Una posible limitación es que el borde biselado contribuye a que el punto de taladrado se desvíe, por lo que a menudo es necesario puntear el agujero para mejorar la precisión.

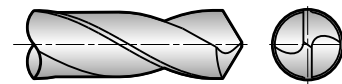

- **Divididas:** las puntas divididas (comúnmente llamadas puntas de cigüeñal) se desarrollaron originalmente para su uso en agujeros profundos de aceite en los cigüeñales de los automóviles. Desde su creación, el uso de las puntas divididas se ha generalizado y se aplica a los ángulos de punta incluidos de 118° y 135°. Sus principales ventajas son la capacidad de reducir la fuerza y eliminar el

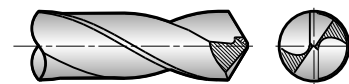



BROCAS DE METAL DURO Y HSS: INFORMACIÓN TÉCNICA

- **Ranuradas:** las puntas ranuradas se crearon para taladrar aleaciones resistentes. Normalmente se incorporan a las brocas de alma dura, lo que permite que la punta resista las mayores cargas de empuje que se requieren en el taladrado de estos materiales. Al igual que la punta dividida, la punta ranurada contiene dos filos de corte adicionales con ángulo de desprendimiento positivo que se extienden hacia el centro de la broca. Estos labios de corte secundarios —que no se prolongan más allá de la mitad del labio de corte original— pueden ayudar a controlar la viruta y reducir el par necesario para taladrar materiales difíciles de mecanizar. Las puntas ranuradas se pueden incorporar en puntas con ángulo de 118° y de 135°, por lo que son ideales para taladrar en una amplia variedad de materiales.

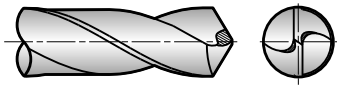

Indicaciones generales sobre el taladrado

1. Seleccione la broca más adecuada para la aplicación, teniendo en cuenta el material que se va a mecanizar, la capacidad de la máquina-herramienta y el refrigerante empleado.
2. La flexibilidad dentro del componente y del husillo de la máquina-herramienta puede provocar daños en la broca, así como en el componente y la máquina: asegúrese de que haya la máxima estabilidad en todo momento. Esta puede mejorarse seleccionando la broca más corta posible para la aplicación.
3. La sujeción de la herramienta es un aspecto importante de la operación de taladrado, por lo que no se puede permitir que la broca se deslice o se mueva en el portaherramientas.
4. El uso correcto de las brocas con mango cónico Morse depende de un ajuste perfecto entre las superficies cónicas de la herramienta y el portaherramientas. Se debe utilizar un martillo suave para introducir la broca en el portaherramientas.
5. Se recomienda utilizar refrigerantes y lubricantes adecuados según lo requiera la operación de taladrado en cuestión. Cuando se utilicen refrigerantes y lubricantes, hay que asegurar un suministro abundante, especialmente en la punta de la broca.
6. La evacuación de las virutas durante el taladrado es esencial para garantizar un correcto proceso de taladrado. No permita que las virutas se queden estancadas en el canal.
7. Al reafilarse una broca, asegúrese siempre de que se genera la geometría de punta correcta y de que se ha eliminado cualquier rastro de desgaste.

- **Ángulo de la punta:** el ángulo incluido entre los labios de corte proyectados sobre un plano paralelo al eje de la broca y paralelo a los dos labios de corte.
- **Altura de labio relativa:** diferencia en la lectura del indicador entre los labios de corte de una broca, medida en ángulo recto al labio de corte a una distancia específica desde el eje de la herramienta.
- **Mango:** la sección por la que se sujeta e impulsa la broca.
- **Espiga:** extremo aplanado de un mango cónico, destinado a encajar en una ranura de posicionamiento en un manguito.
- **Espiga de posicionamiento:** dos planos de arrastre paralelos opuestos en el extremo de un mango recto.
- **Mango cónico:** brocas con mango cónico, apropiadas para el montaje directo en husillos de máquinas, casquillos de arrastre o manguitos. Por lo general, los mangos cónicos llevan una espiga.
- **Alma:** porción central del cuerpo que actúa como unión de las partes planas. El extremo del alma forma el borde biselado en una broca de dos canales.
- **Espesor del alma:** el espesor del alma en la punta, salvo que se indique otra ubicación específica.

TABLA DE VELOCIDADES DE AVANCE DE TALADRADO

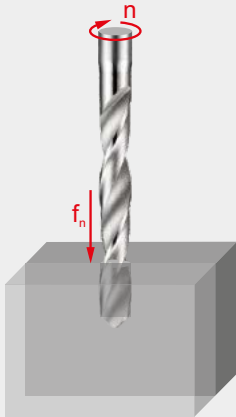

Avance por revolución (f_n en mm/rev)
 Dependiendo de las condiciones de trabajo puede ser necesario ajustar estos valores $\pm 25\%$

Cómo utilizar esta tabla para encontrar el valor de avance por revolución (f_n):

1. Localice su código alfa en la página del producto (ejemplo: 46J, «J» es el código alfa).
2. Localice en la fila superior de la tabla el diámetro más adecuado para su aplicación de corte.
3. Localice su código alfa en la columna de la izquierda de la tabla.
4. La intersección (celda) del diámetro y el código alfa es el avance por revolución (f_n).

		ø DC (mm)																		
		0.15	0.50	1.00	2.00	3.00	4.00	5.00	6.00	8.00	10.00	12.00	15.00	16.00	20.00	25.00	30.00	40.00	50.00	100.00
Avances (mm/rev)	A	0.003	0.006	0.012	0.023	0.029	0.032	0.036	0.042	0.054	0.062	0.069	0.082	0.086	0.110	0.125	0.135	0.155	0.175	0.263
	B	0.004	0.007	0.014	0.028	0.037	0.041	0.046	0.053	0.067	0.080	0.090	0.103	0.108	0.135	0.153	0.165	0.188	0.208	0.312
	C	0.004	0.008	0.015	0.032	0.044	0.050	0.056	0.064	0.080	0.098	0.110	0.125	0.130	0.160	0.180	0.195	0.220	0.240	0.360
	D	0.004	0.008	0.016	0.038	0.053	0.060	0.068	0.078	0.098	0.119	0.130	0.149	0.155	0.188	0.210	0.228	0.253	0.275	0.413
	E	0.004	0.009	0.017	0.043	0.062	0.071	0.080	0.092	0.115	0.140	0.150	0.173	0.180	0.215	0.240	0.260	0.285	0.310	0.465
	F	0.005	0.009	0.018	0.050	0.073	0.084	0.095	0.109	0.138	0.165	0.178	0.202	0.210	0.248	0.275	0.295	0.320	0.343	0.515
	G	0.005	0.010	0.019	0.056	0.084	0.096	0.109	0.126	0.160	0.190	0.205	0.231	0.240	0.280	0.310	0.330	0.355	0.375	0.563
	H	0.005	0.010	0.020	0.066	0.102	0.116	0.130	0.150	0.190	0.228	0.243	0.271	0.280	0.320	0.355	0.375	0.398	0.418	0.627
	I	0.005	0.011	0.021	0.076	0.119	0.134	0.150	0.173	0.220	0.265	0.280	0.310	0.320	0.360	0.400	0.420	0.440	0.460	0.690
	J	0.006	0.012	0.024	0.084	0.135	0.152	0.170	0.197	0.250	0.298	0.315	0.349	0.360	0.405	0.445	0.465	0.485	0.503	0.755
	K	0.007	0.013	0.026	0.092	0.150	0.170	0.190	0.220	0.280	0.330	0.350	0.388	0.400	0.450	0.490	0.510	0.530	0.545	0.818
	L	0.007	0.014	0.028	0.101	0.165	0.186	0.208	0.240	0.305	0.360	0.385	0.419	0.430	0.485	0.525	0.545	0.568	0.588	0.882
	M	0.008	0.015	0.030	0.110	0.180	0.202	0.225	0.260	0.330	0.390	0.420	0.450	0.460	0.520	0.560	0.580	0.605	0.630	0.945
	N	0.008	0.016	0.032	0.119	0.195	0.218	0.242	0.280	0.355	0.420	0.455	0.481	0.490	0.555	0.595	0.615	0.642	0.672	1.008
	S	0.002	0.004	0.008	0.014	0.020	0.025	0.030	0.037	0.050	0.080	0.100	0.123	0.130	0.150	0.170	0.190	0.220	0.240	-
	T	0.004	0.008	0.015	0.028	0.040	0.050	0.060	0.070	0.090	0.110	0.130	0.160	0.170	0.190	0.210	0.230	0.260	0.275	-
	U	0.007	0.013	0.026	0.048	0.070	0.080	0.090	0.107	0.140	0.170	0.200	0.223	0.230	0.240	0.270	0.300	0.360	0.375	-
	V	0.010	0.019	0.038	0.069	0.100	0.115	0.130	0.153	0.200	0.250	0.280	0.310	0.320	0.340	0.400	0.440	0.510	0.530	-
	W	0.012	0.025	0.049	0.089	0.130	0.150	0.170	0.200	0.260	0.330	0.380	0.418	0.430	0.450	0.470	0.490	0.520	0.540	-
	X	0.014	0.028	0.056	0.103	0.150	0.180	0.210	0.250	0.330	0.420	0.480	0.533	0.550	0.580	-	-	-	-	-
Y	0.017	0.034	0.068	0.124	0.180	0.220	0.260	0.317	0.430	0.550	0.700	0.700	0.700	0.740	-	-	-	-	-	
Z	0.024	0.047	0.094	0.172	0.250	0.325	0.400	0.533	0.800	1.000	1.100	1.175	1.200	1.200	-	-	-	-	-	

Fórmulas (sistema métrico)		Términos		Fórmulas (sistema imperial)	
$v_c = \frac{n \times DC \times \pi}{1000}$	v_c	(m/min)	Velocidad de corte	SFM	(pies/min)
	n	(rev/min)	Velocidad del husillo	RPM	(rev/min)
$n = \frac{v_c \times 1000}{DC \times \pi}$	V_f	(mm/min)	Velocidad de avance	IPM	(pulgadas/min)
	f_z	(mm/diente)	Avance por diente	IPT	(in/diente)
$V_f = f_z \times z \times n$	DC	(mm)	Diámetro de corte	DC	(in)
$f_z = \frac{V_f}{z \times n}$	z	(-)	Número de dientes	T	(-)
$Q = \frac{V_f \times a_p \times a_e}{1000}$	a_p	(mm)	Profundidad de corte	DOC	(in)
	a_e	(mm)	Ancho de corte	WOC	(in)
	Q	(cm ³ /min)	Tasa de eliminación de metal	MRR	(pulg. ³ /min)
				$SFM = \frac{RPM \times DC \times \pi}{12}$ $RPM = \frac{SFM \times 12}{DC \times \pi}$ $IPM = IPT \times T \times RPM$ $IPT = \frac{IPM}{T \times RPM}$ $MRR = IPM \times DOC \times WOC$	

INFORMACIÓN TÉCNICA GENERAL

Tabla de velocidades de corte

		Vc															
m/min		5	8	10	15	20	25	30	40	50	60	70	80	90	100	110	150
SFM (pies/min)		16	26	32	50	66	82	98	130	165	197	230	262	296	330	362	495
Ø		RPM															
mm	pulgadas																
1.00	–	1592	2546	3183	4775	6366	7958	9549	12732	15916	19099	22282	25465	28648	31831	35014	47747
1.50	–	1061	1698	2122	3183	4244	5305	6366	8488	10610	12732	14854	16977	19099	21221	23343	31831
2.00	–	796	1273	1592	2387	3183	3979	4775	6366	7958	9549	11141	12732	14324	15916	17507	23873
2.50	–	637	1019	1273	1910	2546	3183	3820	5093	6366	7639	8913	10186	11459	12732	14006	19099
3.00	–	531	849	1061	1592	2122	2653	3183	4244	5305	6366	7427	8488	9549	10610	11671	15916
3.18	1/8	500	801	1001	1501	2002	2502	3003	4004	5005	6006	7007	8008	9009	10010	11011	15015
3.50	–	455	728	909	1364	1819	2274	2728	3638	4547	5457	6366	7276	8185	9095	10004	13642
4.00	–	398	637	796	1194	1592	1989	2387	3183	3979	4775	5570	6366	7162	7958	8754	11937
4.50	–	354	566	707	1061	1415	1768	2122	2829	3537	4244	4951	5659	6366	7074	7781	10610
4.76	3/16	334	535	669	1003	1337	1672	2006	2675	3344	4012	4681	5350	6018	6687	7356	10031
5.00	–	318	509	637	955	1273	1592	1910	2546	3183	3820	4456	5093	5730	6366	7003	9549
6.00	–	265	424	531	796	1061	1326	1592	2122	2653	3183	3714	4244	4775	5305	5836	7958
6.35	1/4	251	401	501	752	1003	1253	1504	2005	2506	3008	3509	4010	4511	5013	5514	7519
7.00	–	227	364	455	682	909	1137	1364	1819	2274	2728	3183	3638	4093	4547	5002	6821
7.94	5/16	200	321	401	601	802	1002	1203	1604	2004	2405	2806	3207	3608	4009	4410	6013
8.00	–	199	318	398	597	796	995	1194	1592	1989	2387	2785	3183	3581	3979	4377	5968
9.00	–	177	283	354	531	707	884	1061	1415	1768	2122	2476	2829	3183	3537	3890	5305
9.53	3/8	167	267	334	501	668	835	1002	1336	1670	2004	2338	2672	3006	3340	3674	5010
10.00	–	159	255	318	477	637	796	955	1273	1592	1910	2228	2546	2865	3183	3501	4775
11.11	7/16	143	229	287	430	573	716	860	1146	1433	1719	2006	2292	2579	2865	3152	4298
12.00	–	133	212	265	398	531	663	796	1061	1326	1592	1857	2122	2387	2653	2918	3979
12.70	1/2	125	201	251	376	501	627	752	1003	1253	1504	1754	2005	2256	2506	2757	3760
14.00	–	114	182	227	341	455	568	682	909	1137	1364	1592	1819	2046	2274	2501	3410
14.29	9/16	111	178	223	334	446	557	668	891	1114	1337	1559	1782	2005	2228	2450	3341
15.00	–	106	170	212	318	424	531	637	849	1061	1273	1485	1698	1910	2122	2334	3183
15.88	5/8	100	160	200	301	401	501	601	802	1002	1203	1403	1604	1804	2004	2205	3007
16.00	–	99	159	199	298	398	497	597	796	995	1194	1393	1592	1790	1989	2188	2984
17.46	11/16	91	146	182	273	365	456	547	729	912	1094	1276	1458	1641	1823	2005	2735
18.00	–	88	141	177	265	354	442	531	707	884	1061	1238	1415	1592	1768	1945	2653
19.05	3/4	84	134	167	251	334	418	501	668	835	1003	1170	1337	1504	1671	1838	2506
20.00	–	80	127	159	239	318	398	477	637	796	955	1114	1273	1432	1592	1751	2387
24.00	–	66	106	133	199	265	332	398	531	663	796	928	1061	1194	1326	1459	1989
25.00	–	64	102	127	191	255	318	382	509	637	764	891	1019	1146	1273	1401	1910
27.00	–	59	94	118	177	236	295	354	472	589	707	825	943	1061	1179	1297	1768
30.00	–	53	85	106	159	212	265	318	424	531	637	743	849	955	1061	1167	1592
32.00	–	50	80	99	149	199	249	298	398	497	597	696	796	895	995	1094	1492
36.00	–	44	71	88	133	177	221	265	354	442	531	619	707	796	884	973	1326
40.00	–	40	64	80	119	159	199	239	318	398	477	557	637	716	796	875	1194
50.00	–	32	51	64	95	127	159	191	255	318	382	446	509	573	637	700	955



ESCARIADO: INFORMACIÓN TÉCNICA

Definiciones y nomenclatura del escariador

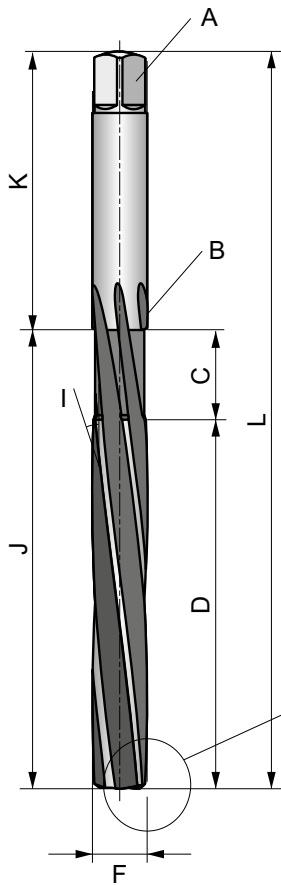

A	Espiga o cuadradillo de arrastre	G	Paso biselado
B	Diámetro de sangrado	H	Ángulo del chaflán de entrada
C	Longitud de sangrado	I	Angulo de helice
D	Longitud de corte	J	Longitud del cuerpo
E	Longitud del paso biselado	K	Longitud del mango
F	Diámetro	L	Longitud total

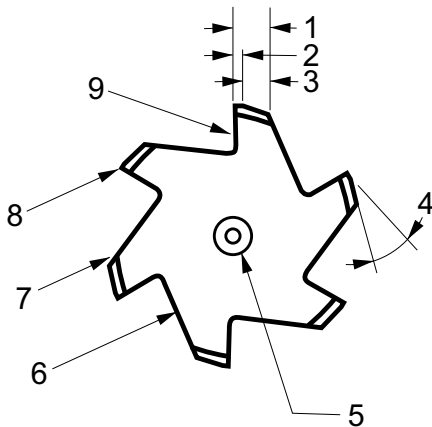
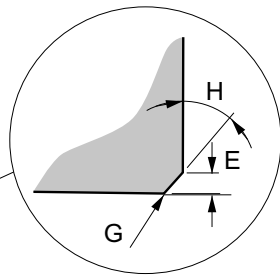

1	Ancho de la parte plana
2	Cara plana circular
3	Espacio libre
4	Ángulo de desprendimiento
5	Agujero central
6	Canal
7	Talón
8	Filo de corte
9	Cara

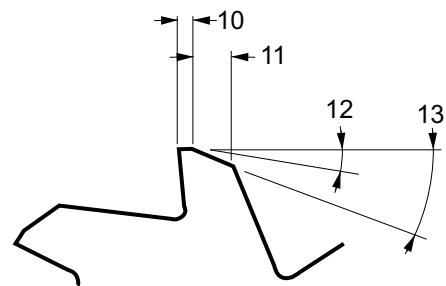

10	Ancho de holgura primaria
11	Ancho de holgura secundaria
12	Ángulo de salida primaria
13	Ángulo de salida secundaria

ESCARIADO: INFORMACIÓN TÉCNICA

Escariado

Para obtener los mejores resultados con los escariadores, es esencial hacerlos ‘trabajar’. Un error frecuente es el de preparar orificios para escariar dejando dentro poco material. Si se deja en el orificio material insuficiente antes de escariar, el escariador rozará, se desgastará rápidamente y el resultado será la pérdida de diámetro. Para garantizar un buen rendimiento, también es importante no dejar demasiado material en el agujero. (Véase el apartado “Eliminación de material” a continuación).

1. Seleccionar el tipo óptimo de escariador y las velocidades y avances óptimos para la aplicación. Asegurar que los agujeros pretaladrados sean del diámetro correcto.
2. La pieza de trabajo debe sujetarse rígida y el husillo de la máquina no debe tener juego.
3. El portapinzas en el que se sujeta un escariador de mango recto debe ser de buena calidad. Si el escariador resbala en el portapinzas y el avance es automático, el escariador podría romperse.
4. Mantener al mínimo el voladizo de la herramienta respecto al husillo de la máquina.

5. Usar los lubricantes recomendados para prolongar la vida útil del escariador y asegurar que el fluido llegue a los filos de corte. Como la operación de escariar no es un trabajo de corte pesado, normalmente bastará una disolución 40:1 de aceite soluble. Cuando se trata de mecanizado en seco, se puede emplear aire a presión (ej. con el mecanizado de acero de fundición gris).
6. No permitir que las estrías del escariador se atasquen de virutas.
7. Antes de volver a reafilear el escariador, comprobar la concentricidad entre centros. En la mayoría de los casos, sólo habrá que rectificar el paso del bisel.
8. Mantener afilados los escariadores. El reafileado frecuente es rentable, pero es importante entender que los escariadores sólo cortan en el chaflán de entrada y no en las superficies entre estrías. Por lo tanto, sólo hay que rectificar dichas superficies. La exactitud de la rectificación es importante para la calidad del acabado del orificio y la vida útil de la herramienta.

Eliminación de material

La eliminación de material recomendada al escariar depende del material de aplicación y el acabado de la superficie del orificio pretaladrado. En la siguiente tabla se dan las directrices generales para la eliminación de material:

Tamaño del agujero escariado (mm)	Con pretaladrado	Con pretaladrado de núcleo
Menos de 4	0.1	0.1
De 4 a 11	0.2	0.15
De 11 a 39	0.3	0.2
De 39 a 50	0.4	0.3

Tamaño del agujero escariado (pulgadas)	Con pretaladrado	Con pretaladrado de núcleo
Menos de 3/16"	0.004"	0.004"
3/16" a 1/2"	0.008"	0.006"
1/2" a 1.1/2"	0.010"	0.008"
1.1/2" a 2"	0.016"	0.010"

ESCARIADO MANUAL/A MÁQUINA

Aunque tanto los escariadores manuales como los de máquina ofrecen la misma capacidad en cuanto al tamaño del agujero terminado, el uso de uno u otro debe considerarse según la aplicación. Por razones de alineación, un escariador manual tiene una entrada cónica larga, mientras que un escariador de máquina cuenta con un paso biselado de tan solo 45°. Un escariador de máquina solo corta en el paso biselado, mientras que un escariador manual corta tanto en el paso biselado como en el cónico.

Los tipos más comunes de escariadores tienen una espiral a la izquierda, ya que las principales aplicaciones incluyen agujeros pasantes que requieren que las virutas sean impulsadas hacia adelante. Para los agujeros ciegos se recomienda el uso de escariadores con canales rectos o espirales a la derecha.

Las condiciones de escariado más eficaces dependen de la aplicación, el material, la calidad del agujero requerido, el arranque de viruta, la lubricación y otros factores. En las tablas de WMG y de avance de los escariadores de máquina (véase el catálogo de Dormer o el selector

de productos) y en las tablas de arranque de viruta se muestra una guía general de las velocidades superficiales y los avances de los escariadores.

El espacio extremadamente desigual en los escariadores significa que la división no es la misma para cada diente. Como no hay dos dientes diametralmente opuestos, el escariador produce un agujero con una variación de redondez de entre 1 y 2 µm. La diferencia es de hasta 10µm con el espaciado desigual convencional.

Escariadores de metal duro: comparación de espaciado/espaciado europeo

Espaciado desigual
Error de redondez de hasta 10 µm

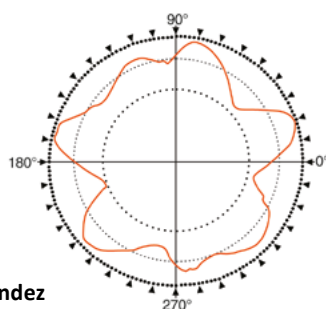

Resultados de redondez

Espaciado extremadamente desigual
Error de redondez de hasta 1-2 µm

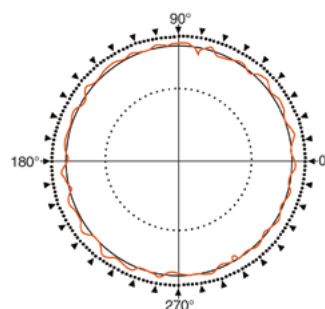

Resultados de redondez

ESCARIADO: LÍMITES DE TOLERANCIA E INFORMACIÓN TÉCNICA

Límites de tolerancia

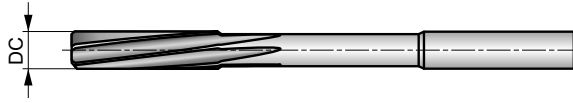

1. En el diámetro de corte de los escariadores estándar

El diámetro (DC) se mide sobre la superficie circular entre estrías inmediatamente detrás del bisel o paso cónico. La tolerancia se ajusta a DIN 1420 y sirve para producir agujeros H7.

TOLERANCIA DEL ESCARIADOR			
Diámetro (mm)		Límite de tolerancia (mm)	
Por encima de	Hasta e incluido	Alto +	Bajo +
-	3	0.008	0.004
3	6	0.010	0.005
6	10	0.012	0.006
10	18	0.015	0.008

TOLERANCIA DEL ESCARIADOR			
Diámetro (mm)		Límite de tolerancia (mm)	
Por encima de	Hasta e incluido	Alto +	Bajo +
18	30	0.017	0.009
30	50	0.021	0.012
50	80	0.025	0.014

2. En un agujero H7

La tolerancia más común en un agujero acabado es H7 (ver la tabla de abajo). Para cualquier otra tolerancia, ver la figura y la tabla del punto 3 (se muestra más abajo); esta tabla se puede usar para calcular el ancho y la ubicación de tolerancia de los escariadores.

TOLERANCIA DEL AGUJERO			
Diámetro (mm)		Límite de tolerancia (mm)	
Por encima de	Hasta e incluido	Alto +	Bajo +
-	3	0.010	0
3	6	0.012	0
6	10	0.015	0
10	18	0.018	0

TOLERANCIA DEL AGUJERO			
Diámetro (mm)		Límite de tolerancia (mm)	
Por encima de	Hasta e incluido	Alto +	Bajo +
18	30	0.021	0
30	50	0.025	0
50	80	0.030	0

3. Cuando es necesario definir las dimensiones para un escariador especial para cortar según una tolerancia específica, por ejemplo D8, se puede usar esta guía.

Ancho de tolerancia del diámetro (µm)								
Ancho de tolerancia (micrones)	por encima de 1 incl. 3	por encima de 3 incl. 6	por encima de 6 incl. 10	por encima de 10 incl. 18	por encima de 18 incl. 30	por encima de 30 incl. 50	por encima de 50 incl. 80	por encima de 80 incl. 120
IT5	4	5	6	8	9	11	13	15
IT6	6	8	9	11	13	16	19	22
IT7	10	12	15	18	21	25	30	35
IT8	14	18	22	27	33	39	46	54
IT9	25	30	36	43	52	62	74	87
IT10	40	48	58	70	84	100	120	140
IT11	60	75	90	110	130	160	190	220
IT12	100	120	150	180	210	250	300	350

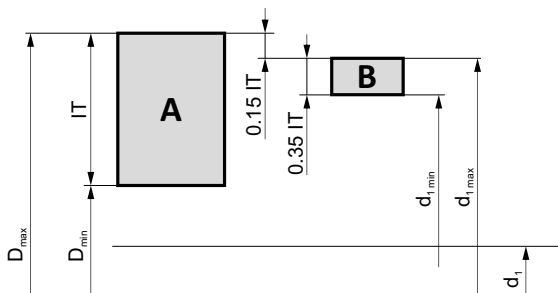

- A = Tolerancia del Agujero
- B = Tolerancia del Escariador
- IT = Ancho de tolerancia
- D_{max} = Diámetro máx. del agujero
- D_{min} = Diámetro mín. del agujero
- d_1 = Diámetro nominal
- d_{1max} = Diámetro máx. del escariador
- d_{1min} = Diámetro mín. del escariador

por ejemplo: agujero de 10 mm con tolerancia D8, diám. máx. = 10,062, diám. mín. = 10,040, toler. del agujero (IT8) = 0,022

Límite máximo: $0.15 \times$ tolerancia de agujero (IT8) = 0.0033, redondeado = 0.004

Límite mínimo: $0.35 \times$ tolerancia de agujero (IT8) = 0.0077, redondeado = 0.008

Límite máximo para escariador = $10.062 - 0.004 = 10.058$

Límite mínimo para escariador = $10.058 - 0.008 = 10.050$

TABLA DE VELOCIDADES DE AVANCE PARA ESCARIADORES

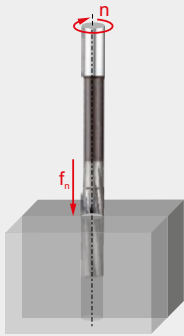

Avance por revolución (f_n en mm/rev)
 Dependiendo de las condiciones de trabajo puede ser necesario ajustar estos valores $\pm 15\%$

Cómo utilizar esta tabla para encontrar el valor de avance por revolución (f_n):

1. Localice su código alfa en la página del producto (ejemplo: 21C, «C» es el código alfa).
2. Localice en la fila superior de la tabla el diámetro más adecuado para su aplicación de corte.
3. Localice su código alfa en la columna de la izquierda de la tabla.
4. La intersección (celda) del diámetro y el código alfa es el avance por revolución (f_n).

		ϕ DC (mm)																		
		1.00	1.50	2.00	3.00	4.00	5.00	6.00	7.00	8.00	10.00	12.00	15.00	16.00	20.00	25.00	30.00	40.00	50.00	80.00
Avances (mm/rev)	A	0.030	0.045	0.055	0.078	0.090	0.100	0.125	0.137	0.150	0.170	0.185	0.210	0.220	0.250	0.280	0.320	0.390	0.440	0.500
	B	0.035	0.055	0.072	0.110	0.130	0.150	0.165	0.172	0.180	0.210	0.240	0.270	0.280	0.310	0.360	0.400	0.500	0.550	0.600
	C	0.040	0.065	0.085	0.135	0.160	0.185	0.200	0.210	0.220	0.260	0.285	0.325	0.335	0.390	0.440	0.480	0.600	0.680	0.750
	D	0.050	0.080	0.110	0.160	0.180	0.200	0.235	0.253	0.270	0.320	0.360	0.400	0.410	0.470	0.540	0.600	0.730	0.850	0.950
	E	0.065	0.100	0.140	0.180	0.215	0.250	0.300	0.325	0.350	0.390	0.430	0.485	0.500	0.530	0.640	0.750	0.910	1.100	1.200
	F	0.090	0.140	0.180	0.260	0.305	0.350	0.395	0.417	0.440	0.500	0.550	0.610	0.630	0.700	0.800	0.930	1.200	1.500	1.650

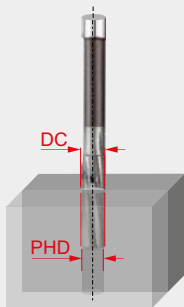

Sobreespesor de mecanizado al utilizar un **escariador de máquina** (MA en mm)
 Diámetro de agujero premecanizado
 $PHD = DC - MA$

Cómo utilizar esta tabla para encontrar el diámetro correcto del agujero premecanizado (PHD):

1. Localice en la fila superior de la tabla el rango de diámetro más adecuado para su aplicación de corte.
2. Localice su código de grupo ISO en la columna de la izquierda de la tabla (ejemplo: para el acero inoxidable, el código de grupo ISO es «M»)
3. La intersección (celda) del rango de diámetro y el código de grupo ISO es el sobreespesor de mecanizado (MA)
4. Reste el sobreespesor de mecanizado al diámetro de escariado para obtener el diámetro de agujero premecanizado (PHD).

(Ejemplo: para un agujero de 6 mm en acero (P), el PHD es de 5,85 mm)

		ϕ DC (mm)																
		1.00	5.00	5.00	8.00	8.00	12.00	12.00	16.00	16.00	30.00	30.00	80.00					
Grupo ISO	P	0.10			0.15			0.20				0.20			0.30			0.30
	M	0.08			0.10			0.10				0.20			0.20			0.30
	K	0.10			0.15			0.20				0.20			0.30			0.30
	N	0.10			0.15			0.20				0.20			0.30			0.30
	S	0.05			0.10			0.10				0.15			0.20			0.20
	H	0.05			0.05			0.10				0.10			0.15			0.20

Tenga cuidado con las tolerancias de mecanizado de las brocas, ya que el diámetro de la herramienta no es el mismo que el diámetro del agujero producido.

Nota: El sobreespesor recomendado al utilizar un escariador manual es de 0,05 a 0,10 mm

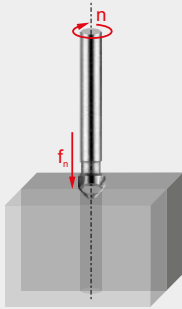
**TABLA DE VELOCIDADES DE AVANCE PARA AVELLANADORES**

Avance por revolución (f_n en mm/rev)
Dependiendo de las condiciones de trabajo puede ser necesario ajustar estos valores $\pm 15\%$

Cómo utilizar esta tabla para encontrar el valor de avance por revolución (f_n):

1. Localice su código alfa en la página del producto (ejemplo: 23E, «E» es el código alfa).
2. Localice en la fila superior de la tabla el diámetro más adecuado para su aplicación de corte.
3. Localice su código alfa en la columna de la izquierda de la tabla.
4. La intersección (celda) del diámetro y el código alfa es el avance por revolución (f_n).

	$\varnothing DC$ (mm)										
	6.00	8.00	10.00	16.00	20.00	25.00	32.00	40.00	60.00	80.00	
Avances (mm/rev)	A	0.030	0.040	0.050	0.060	0.080	0.090	0.100	0.120	0.140	0.160
	B	0.040	0.050	0.060	0.080	0.100	0.120	0.140	0.160	0.180	0.200
	C	0.050	0.060	0.080	0.100	0.120	0.140	0.160	0.180	0.200	0.220
	D	0.060	0.080	0.100	0.120	0.150	0.180	0.200	0.220	0.250	0.280
	E	0.080	0.100	0.120	0.150	0.180	0.200	0.250	0.270	0.300	0.320
	F	0.090	0.110	0.130	0.160	0.190	0.210	0.260	0.290	0.330	0.360
	G	0.100	0.120	0.150	0.180	0.200	0.220	0.280	0.320	0.360	0.400
	H	0.120	0.150	0.180	0.200	0.220	0.250	0.300	0.350	0.400	0.450

HYDRA: INFORMACIÓN TÉCNICA

Tabla de pares

H860	H861	Ø cabeza Hydra gama métrica	Ø cabeza Hydra gama fraccional	Ø cabeza Hydra gama de tamanos decimales (min./max.)	Valores de par Nm (sistema métrico)	Valores de par in/lbs (sistema imperial)
H860N1	H861N1	12.0 mm – 15.5 mm	15/32" – 39/64"	0.4688" – 0.6102"	0.75 – 0.99	6.6 – 8.8
H860N2	H861N2	15.6 mm – 18.5 mm	5/8" – 23/32"	0.6142" – 0.7283v	0.93 – 1.24	8.2 – 11.0
H860N3	H861N3	18.6 mm – 21.5 mm	47/64" – 27/32"	0.7323" – 0.8465"	1.84 – 2.44	16.3 – 21.6
H860N4	H861N3	22.0 mm – 24.5 mm	55/64" – 31/32"	0.8594" – 0.9688"	2.73 – 3.72	24.2 – 32.9
H860N5	H861N4	25.0 mm – 27.5 mm	63/64" – 1-3/32"	0.9843" – 1.0938"	4.14 – 5.52	36.6 – 48.8
H860N6	H861N5	28.0 mm – 33.5 mm	1-7/64" – 1-19/64"	1.1024" – 1.3189"	4.97 – 6.63	44.0 – 58.7
H860N7	H861N6	34.0 mm – 42.0 mm	1-11/32" – 1-5/8"	1.3386" – 1.6535"	7.2	63.7

Datos del tornillo y el destornillador

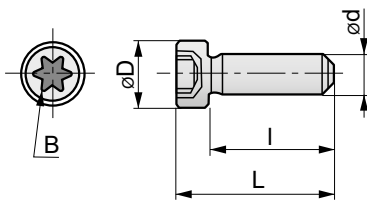

Código e	d	Paso	L (mm)	l (mm)	D (mm)	B
H860N1	M2.2	0.45	7.5	5.7	3.5	8IP
H860N2	M2.5	0.45	9.0	7.0	4.1	10IP
H860N3	M3.0	0.50	10.5	8.0	4.9	15IP
H860N4	M3.5	0.60	11.5	8.8	5.5	15IP
H860N5	M4.0	0.70	12.5	9.5	6.0	20IP
H860N6	M4.5	0.75	14.3	10.8	6.8	25IP

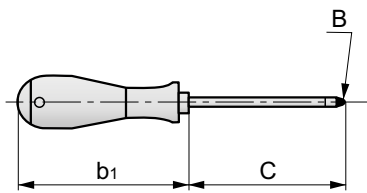

Código e	B	C	b ₁
H861N1	8IP	60	104
H861N2	10IP	80	111
H861N3	15IP	80	111
H861N4	20IP	100	118
H861N5	25IP	100	118

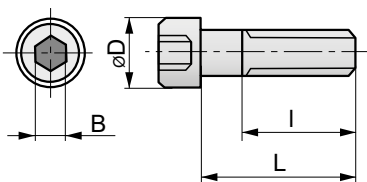

Código e	d	Paso	L (mm)	l (mm)	D (mm)	B
H860N7	M5.0	0.8	15	full	8.5	4

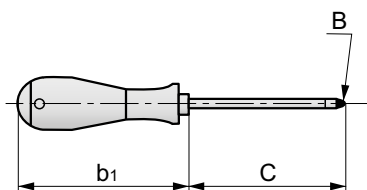

Código e	B	C	b ₁
H861N6	4	75	111

HYDRA: INFORMACIÓN TÉCNICA

Uso del programa especial para el taladrado 8xD y 12xD

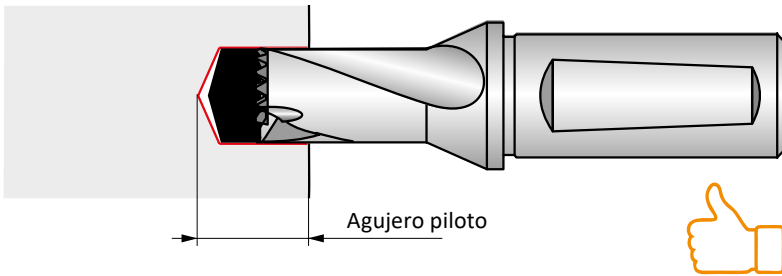

Taladre un agujero piloto (de 1,5xD a 3xD de profundidad) con el mismo diámetro del cabezal HYDRA (si es necesario, compruebe la excentricidad de la broca máx. +/- 0,05 mm).

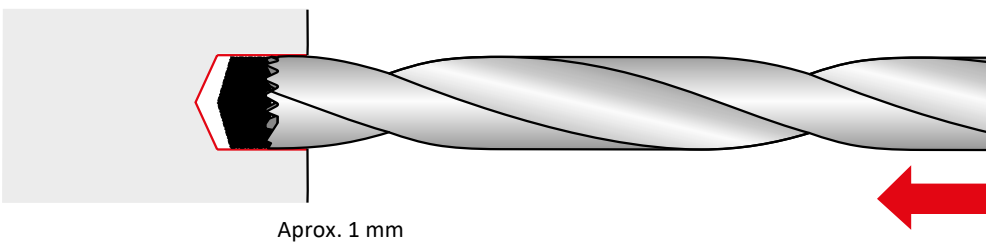

Introduzca el agujero piloto con el cuerpo 8xD o 12xD a un máximo de 500 rpm, hasta aproximadamente 1 mm, por encima de la profundidad del agujero piloto pretaladrado.

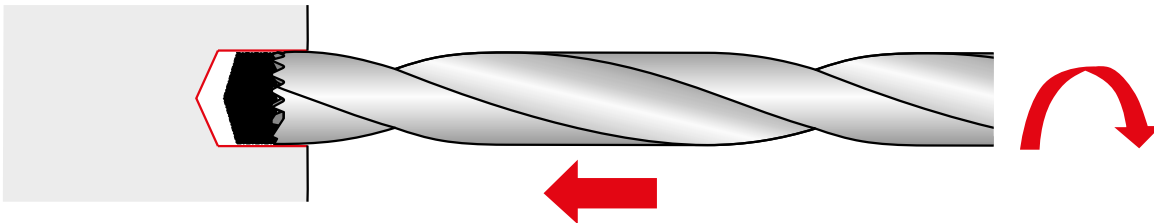

Inicie el flujo de refrigerante y aumente la velocidad de rotación hasta alcanzar el valor de RPM recomendado.

Nota: Aplique un tiempo de permanencia corto y no inicie la alimentación antes de alcanzar el valor de RPM recomendado.

Taladre sin llegar hasta la profundidad requerida.

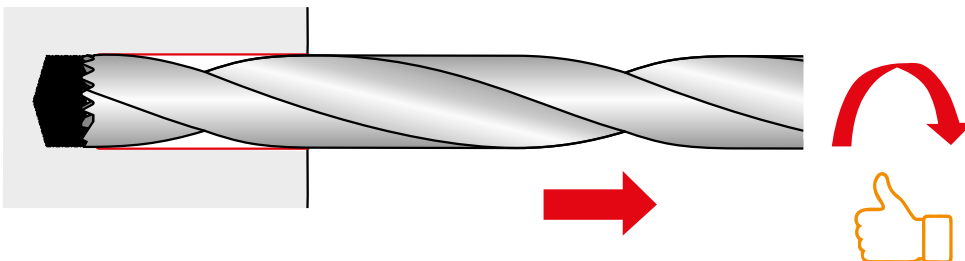

Cuando se alcance la profundidad deseada, retraiga la broca aproximadamente de 0,1 mm a 0,5 mm y reduzca a 500 rpm; a continuación, retraiga la broca por completo con el avance normal. **Nota:** Retraer la broca con una velocidad de husillo más elevada puede provocar un daño en el hombro a causa del rebasamiento o dañar la superficie del agujero y afectar a la tolerancia.

HYDRA: INFORMACIÓN TÉCNICA

Consejos para taladrar con la broca Hydra

Refrigerantes

Para lograr una evacuación de viruta y un rendimiento de la herramienta máximos se recomienda utilizar refrigerante. Se recomienda una concentración de refrigerante en emulsión del 6 al 8 % para la mayoría de las aplicaciones, con una presión de refrigerante de 20 bar (290 PSI) o superior. Para los aceros de alta resistencia, los aceros inoxidable y las aplicaciones de perforación más duras, utilice una concentración más alta, del 10 al 12 %. En estas aplicaciones, especialmente en aceros inoxidable, se recomienda utilizar la máxima presión de refrigerante en la máquina. Las brocas Hydra con lubricación interior proporcionan una mayor resistencia del alma y reducen el calor en los filos de corte para aumentar la productividad y prolongar la vida útil de la herramienta.

Portaherramientas

Utilice siempre portaherramientas y pinzas que garanticen una buena

concentricidad entre la broca y el husillo de la máquina. Utilice un tope positivo para evitar que la herramienta retroceda en el portaherramientas. Se debe comprobar y mantener con precisión la desviación radial en el conjunto de la herramienta.

Pieza

Una pieza segura y rígida minimizará la desviación y permitirá una mayor precisión y una posición real del agujero.

Avances

Es importante no aplicar velocidades de avance muy bajas en la broca, ya que esto provocaría su parada momentánea y que se quedara sin filo. Esto se da especialmente en materiales con endurecimiento por deformación en frío. Las velocidades de avance deben ser lo suficientemente elevadas para permitir la correcta formación de virutas.

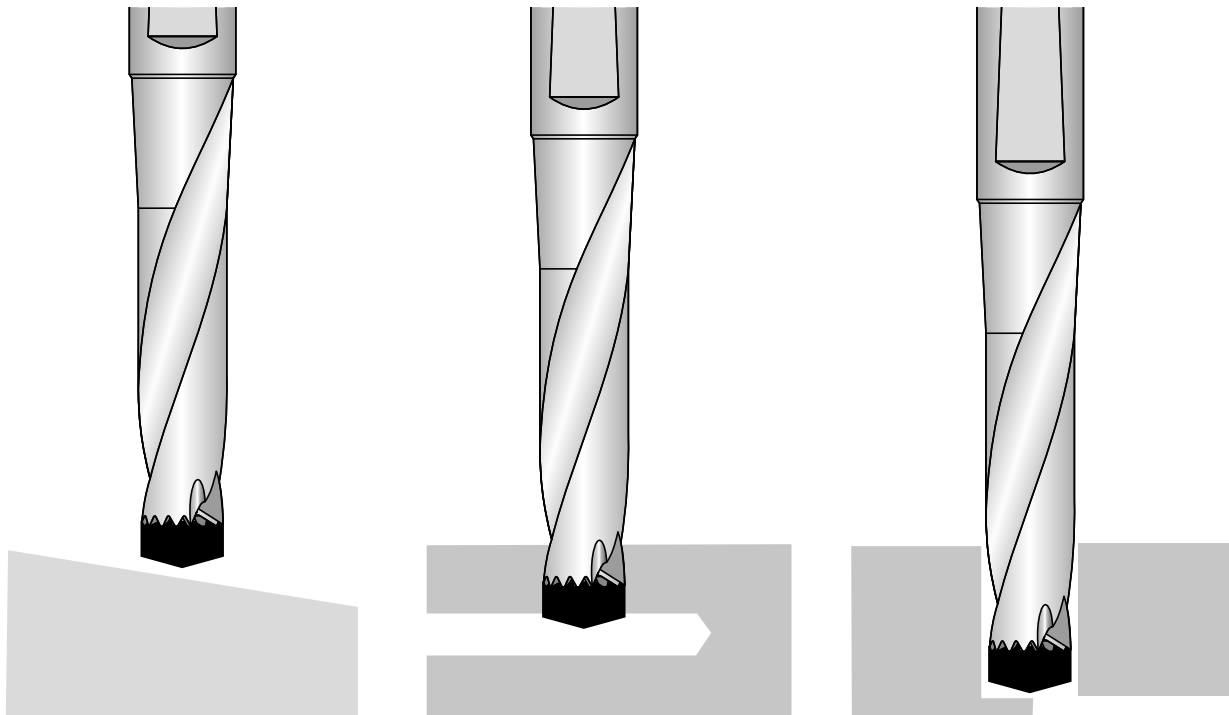

Entrada o salida en una superficie angular

Taladrado a través de agujeros transversales

Interrupción en la salida

En estos casos de taladrado suele ser recomendable reducir la velocidad de avance a 1/3 (33 %). Taladrado NO es recomendable en un ángulo de entrada de más de 10°; en dicho caso, la superficie debe ser fresada plana primero.

CARACTERÍSTICAS DE MECANIZADO PARA BROCAS CON PLAQUITAS INTERCAMBIALES

Ajuste radial

Ajuste del diámetro del agujero y recomendaciones de colocación
 Las brocas de plaquita se pueden desplazar fuera del centro para lograr un diámetro del agujero más pequeño o más grande que con la broca. Los valores de ajuste radial se encuentran en la tabla principal de datos de las brocas.

Broca estacionaria (torno)

Al montar la broca, asegúrese de que la línea del centro de la broca y la línea del centro de la pieza que se trabajará están alineadas. Para lograr un diámetro mayor del agujero, desplace la broca de forma que la plaquita periférica se mueva en ese sentido desde la línea del centro de la pieza que se trabajará.

Broca rotativa (centro de mecanizado)

Para taladrar agujeros con tolerancia IT10 y superior con brocas 802D, 803D, 804D y 805D, se recomienda utilizar soportes ajustables.

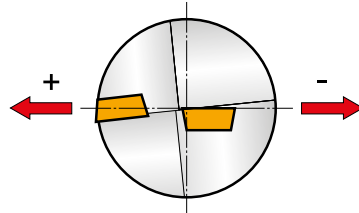

Vida útil de la herramienta

No se deberían utilizar plaquitas con un desgaste en flanco superior a 0,2 – 0,4 mm medidos en el punto mayor. Las recomendaciones acerca de la velocidad de corte que se mencionan en este catálogo se basan en la vida útil de las plaquitas periféricas en agujeros taladrados con una longitud total de 7 m (durabilidad 20 ÷ 30 min).

EP

CASQUILLO AJUSTABLE

Diám. del mango	Diám. broca	Rango
25	15 – 24	+0.4 – -0.2
32	24.5 – 40	+0.4 – -0.2

Ajuste del diámetro – para centro de mecanizado

Rango de ajuste del diámetro

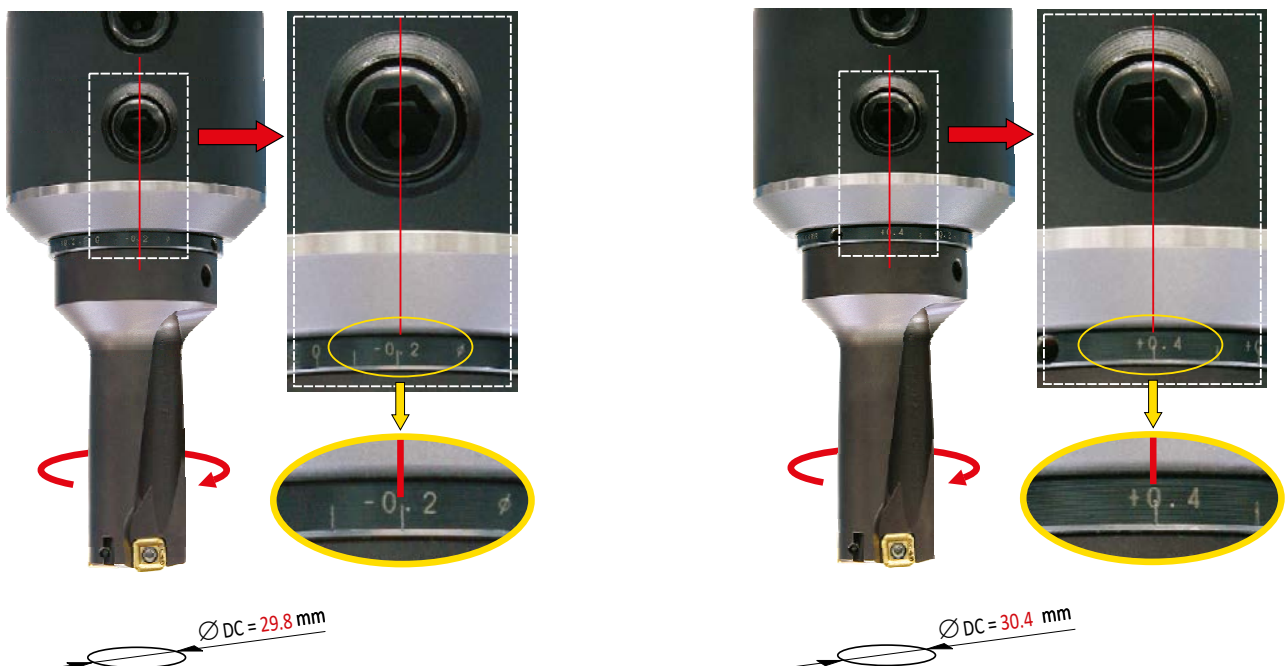

EP

CASQUILLO AJUSTABLE

Diám. del mango	Diám. broca	Rango
25	15 – 24	+0.2 – -0.15
32	24.5 – 40	+0.2 – -0.15

Ajuste del diámetro – para torno

Rango de ajuste de altura centro

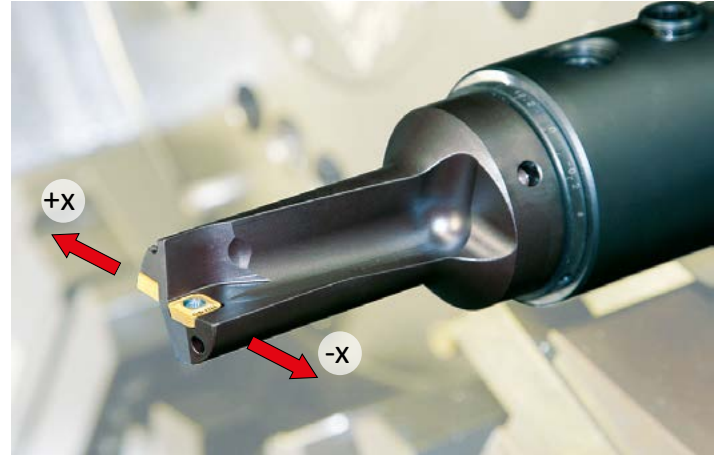

CARACTERÍSTICAS DE MECANIZADO PARA BROCAS CON PLAQUITAS INTERCAMBIABLES

Presion recomendada del fluido de corte

Diámetro de la broca DC (mm)	Presión del liquido de corte	
	Longitud de la broca	
	2.0 – 2.5 DC	3.0 – 5.0 DC
15 – 25	6 bar	12 bar
26 – 40	4.5 bar	9 bar
> 40	3 bar	6 bar

Requisito de volumen de refrigerante

TALADRADO EN SECO

Se puede taladrar fundición o acero sin refrigerante, aunque se necesitará aire presurizado a través de la broca al realizar el taladrado.

Consumo eléctrico neto

 $f \Rightarrow = 0.18$
 $f \Rightarrow = 0.12$
 $f \Rightarrow = 0.08$

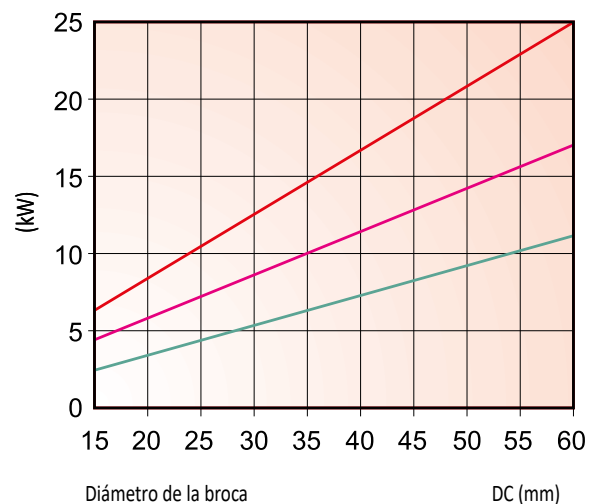
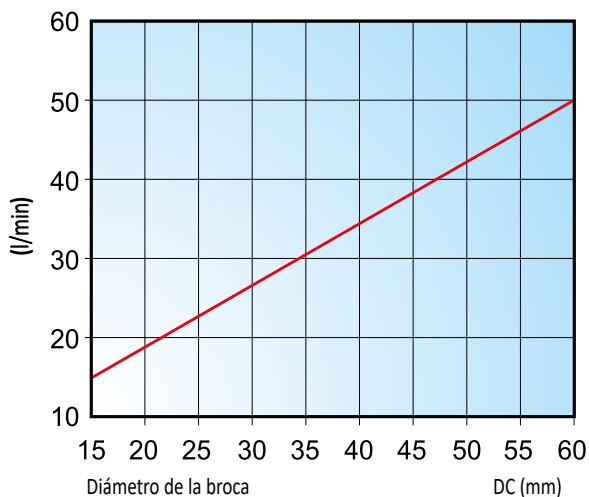

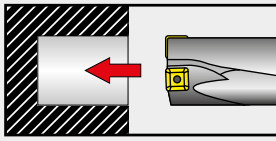
**DATOS DE MECANIZADO GENERALES****TALADRADO DE AGUJERO CIEGO**

Para agujeros con una profundidad mayor de $1xD$ es necesario refrigerante.

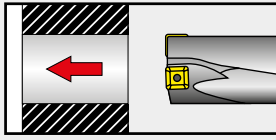
**TALADRADO DE AGUJERO PASANTE**

Se puede producir un disco a la salida de la broca de plaquitas que puede ser proyectado a gran velocidad cuando la pieza esta girando. Es esencial que la máquina esté protegida adecuadamente para garantizar la seguridad del operario.

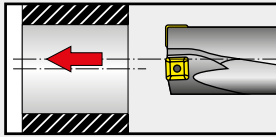
**BROCA DESCENTRADA**

Reducir el avance al mínimo recomendado para las plaquitas utilizadas. Ver la descripción de las plaquitas. No exceder los valores de ajuste radial.

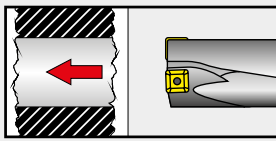
**INICIO DEL TALADRADO EN SUPERFICIES IRREGULARES**

Reducir el avance un 50% a la entrada hasta que las dos plaquitas estén dentro del agujero.

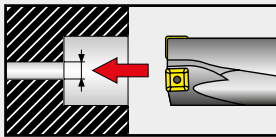
**TALADRADO Y MANDRINADO CON AGUJERO PILOTO**

Si el agujero piloto es mayor de $1/4$ del diámetro de la broca, reducir el avance.

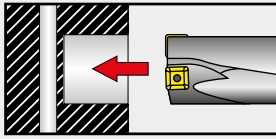
**TALADRADO CON AGUJEROS CRUZADOS**

Reducir el avance un 50% al taladrar a través de un agujero existente. El diámetro de los agujeros cruzados no debe ser mayor de $0,25xD$.

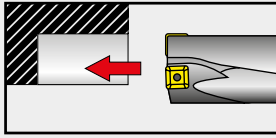
**CORTE INTERRUMPIDO Y PLUNGING**

Reducir el avance al mínimo recomendado para las plaquitas utilizadas. Ver la descripción de las plaquitas.

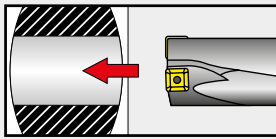
**TALADRADO EN SUPERFICIES CURVAS**

Se puede taladrar con el centro reduciendo el avance al 50% durante la entrada y la salida.

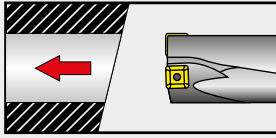
**TALADRADO EN SUPERFICIES INCLINADAS**

Reducir el avance un 50% a la entrada hasta que las dos plaquitas estén dentro del agujero si el ángulo de entrada es mayor de 5° .

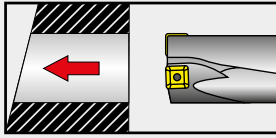
**SALIDA EN SUPERFICIES INCLINADAS**

Reducir el avance un 50% a la salida si el ángulo de salida es mayor de 5° .

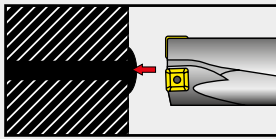
**ENTRADA EN SOLDADURA**

Se recomienda fresar previamente. Reducir el avance un 50% durante el taladrado del material de soldadura.

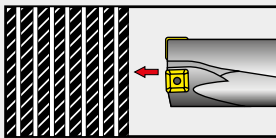
**TALADRADO DE CHAPAS O DE PIEZAS APILADAS**

Evite dejar espacios de más de 0,2 mm entre las diferentes capas. El componente debe estar bien sujeto. En caso necesario, reduzca el avance.

**BROCAS DE PLAQUITA INTERCAMBIABLE: CONDICIONES DE CORTE RECOMENDADAS****802D, 803D (XPET..AP, SCET..-UD)**

	D9335	D8330	D8345	∅ 15	∅ 20	∅ 25	∅ 30	∅ 40	∅ 58
P1	■	■	■	0.07	0.08	0.09	0.10	0.12	0.16
P2	■	■	■	0.11	0.13	0.15	0.17	0.21	0.28
P3	■	■	■	0.13	0.15	0.18	0.20	0.24	0.32
P4	■	■	■	0.12	0.14	0.16	0.18	0.22	0.30
K1	■	■	■	0.14	0.16	0.19	0.21	0.26	0.34
K2	■	■	■	0.14	0.16	0.19	0.21	0.26	0.34
K3	■	■	■	0.14	0.16	0.19	0.21	0.26	0.34
K4	■	■	■	0.14	0.16	0.19	0.21	0.26	0.34
K5	■	■	■	0.14	0.16	0.19	0.21	0.26	0.34

802D, 803D (XPET..AP-SD, SCET..-SD)

	D9335	D8330	D8345	∅ 15	∅ 20	∅ 25	∅ 30	∅ 40	∅ 58
P1	■	■	■	0.08	0.09	0.10	0.11	0.14	0.18
P2	■	■	■	0.11	0.13	0.15	0.17	0.21	0.28
P3	■	■	■	0.13	0.15	0.18	0.20	0.24	0.32
P4	■	■	■	-	-	-	-	-	-
K1	▣	▣	▣	0.08	0.09	0.10	0.11	0.14	0.18
K2	▣	▣	▣	0.11	0.13	0.15	0.17	0.21	0.28
K3	▣	▣	▣	0.12	0.14	0.16	0.18	0.22	0.24
K4	▣	▣	▣	0.13	0.15	0.18	0.20	0.24	0.32
K5	▣	▣	▣	0.14	0.16	0.19	0.21	0.25	0.33
M1	■	■	■	0.12	0.14	0.16	0.18	0.22	0.30
M2	■	■	■	0.11	0.13	0.15	0.17	0.21	0.28
M3	■	■	■	0.07	0.08	0.09	0.10	0.12	0.16
M4	■	■	■	0.07	0.08	0.09	0.10	0.12	0.16
S1	▣	▣	▣	0.08	0.09	0.10	0.11	0.14	0.18
S2	▣	▣	▣	0.08	0.09	0.10	0.11	0.14	0.18
S3	▣	▣	▣	0.07	0.08	0.09	0.10	0.12	0.16
S4	▣	▣	▣	0.07	0.08	0.09	0.10	0.12	0.16

804D (XPET..AP, SCET..-UD)

	D9335	D8330	D8345	∅ 15	∅ 20	∅ 25	∅ 30	∅ 40	∅ 58
P1	■	■	■	0.06	0.07	0.08	0.09	0.10	0.14
P2	■	■	■	0.10	0.12	0.14	0.16	0.19	0.25
P3	■	■	■	0.12	0.14	0.16	0.18	0.22	0.30
P4	■	■	■	0.11	0.13	0.15	0.17	0.21	0.28
K1	■	■	■	0.13	0.15	0.18	0.20	0.24	0.32
K2	■	■	■	0.13	0.15	0.18	0.20	0.24	0.32
K3	■	■	■	0.13	0.15	0.18	0.20	0.24	0.32
K4	■	■	■	0.13	0.15	0.18	0.20	0.24	0.32
K5	■	■	■	0.13	0.15	0.18	0.20	0.24	0.32

BROCAS DE PLAQUITA INTERCAMBIABLE: CONDICIONES DE CORTE RECOMENDADAS

804D (XPET..AP-SD, SCET..-SD)



	D9335	D8330	D8345	∅ 15	∅ 20	∅ 25	∅ 30	∅ 40	∅ 58
P1	■	■	■	0.07	0.08	0.09	0.10	0.12	0.16
P2	■	■	■	0.10	0.12	0.14	0.16	0.19	0.25
P3	■	■	■	0.12	0.14	0.16	0.18	0.22	0.30
P4	■	■	■	-	-	-	-	-	-
K1	▣	▣	▣	0.07	0.08	0.09	0.10	0.12	0.16
K2	▣	▣	▣	0.10	0.12	0.14	0.16	0.19	0.25
K3	▣	▣	▣	0.11	0.13	0.15	0.17	0.20	0.27
K4	▣	▣	▣	0.12	0.14	0.16	0.18	0.22	0.30
K5	▣	▣	▣	0.14	0.16	0.19	0.21	0.25	0.33
M1	■	■	■	0.11	0.13	0.15	0.17	0.21	0.28
M2	■	■	■	0.10	0.12	0.14	0.16	0.19	0.25
M3	■	■	■	0.06	0.07	0.08	0.09	0.10	0.14
M4	■	■	■	0.06	0.07	0.08	0.09	0.10	0.14
S1	▣	▣	▣	0.07	0.08	0.09	0.10	0.12	0.16
S2	▣	▣	▣	0.07	0.08	0.09	0.10	0.12	0.16
S3	▣	▣	▣	0.06	0.07	0.08	0.09	0.10	0.14
S4	▣	▣	▣	0.06	0.07	0.08	0.09	0.10	0.14

805D (XPET..AP, SCET..-UD)



	D9335	D8330	D8345	∅ 15	∅ 20	∅ 25	∅ 30	∅ 40	∅ 58
P1	■	■	■	0.06	0.07	0.08	0.09	0.10	0.14
P2	■	■	■	0.10	0.12	0.14	0.16	0.19	0.25
P3	■	■	■	0.12	0.14	0.16	0.18	0.22	0.30
P4	■	■	■	0.11	0.13	0.15	0.17	0.21	0.28
K1	■	■	■	0.13	0.15	0.18	0.20	0.24	0.32
K2	■	■	■	0.13	0.15	0.18	0.20	0.24	0.32
K3	■	■	■	0.13	0.15	0.18	0.20	0.24	0.32
K4	■	■	■	0.13	0.15	0.18	0.20	0.24	0.32
K5	■	■	■	0.13	0.15	0.18	0.20	0.24	0.32

805D (XPET..AP-SD, SCET..-SD)



	D9335	D8330	D8345	∅ 15	∅ 20	∅ 25	∅ 30	∅ 40	∅ 58
P1	■	■	■	0.07	0.08	0.09	0.10	0.12	0.16
P2	■	■	■	0.10	0.12	0.14	0.16	0.19	0.25
P3	■	■	■	0.12	0.14	0.16	0.18	0.22	0.30
P4	■	■	■	-	-	-	-	-	-
K1	▣	▣	▣	0.07	0.08	0.09	0.10	0.12	0.16
K2	▣	▣	▣	0.10	0.12	0.14	0.16	0.19	0.25
K3	▣	▣	▣	0.11	0.13	0.15	0.17	0.20	0.27
K4	▣	▣	▣	0.12	0.14	0.16	0.18	0.22	0.30
K5	▣	▣	▣	0.12	0.14	0.16	0.18	0.22	0.30
M1	■	■	■	0.11	0.13	0.15	0.17	0.21	0.28
M2	■	■	■	0.10	0.12	0.14	0.16	0.19	0.25
M3	■	■	■	0.06	0.07	0.08	0.09	0.10	0.14
M4	■	■	■	0.06	0.07	0.08	0.09	0.10	0.14
S1	▣	▣	▣	0.07	0.08	0.09	0.10	0.12	0.16
S2	▣	▣	▣	0.07	0.08	0.09	0.10	0.12	0.16
S3	▣	▣	▣	0.06	0.07	0.08	0.09	0.10	0.14
S4	▣	▣	▣	0.06	0.07	0.08	0.09	0.10	0.14



FÓRMULAS DE CÁLCULO DE LOS PARÁMETROS DE CORTE

NOMENCLATURA Y FÓRMULAS

Parámetro	Fórmula	Unidad
Velocidad del husillo	$n = \frac{v_c \cdot 1000}{DC \cdot \pi}$	(rpm/min)
Velocidad de corte	$v_c = \frac{\pi \cdot DC \cdot n}{1000}$	(m/min)
Velocidad de avance	$v_f = n \cdot f$	(mm/min)
Area de la seccion transversal del agujero	$A = \frac{\pi \cdot DC^2}{4}$	(mm ²)
Volumen de viruta	$Q = \frac{v_f \cdot A}{1000}$	(cm ³ /min)
Tiempo de mecanizado	$T_c = \frac{L + h}{v_f}$	[min/pieza]

DC Diámetro de la broca

(mm)

f Avance por revolución

(mm/rev)







h Distancia desde el punto de taladrado hasta la pieza que se trabaja antes de avanzar

(mm)

L Profundidad del agujero

(mm)

FÓRMULAS DE CÁLCULO DE LOS PARÁMETROS DE CORTE

						
US 2245-T07P	0.9	FLAG T07P	M 2.2	5.3	D-T7P	MR-0.8-2.0 vario
US 2205-T07P	0.9	FLAG T07P	M2.2	5.4	D-T7P	MR-0.8-2.0 vario
US 2506-T07P	1.2	FLAG T07P	M 2.5	6	D-T7P	MR-0.8-2.0 vario
US 2507-T08P	1.2	FLAG T08P	M 2.5	7	D-T8P	MR-0.8-2.0 vario
US 3007-T08P	2.0	FLAG T08P	M 3	7	D-T8P	MR-1.0-5.0 vario
US 3007-T09P	2.0	FLAG T09P	M 3	7.4	D-T9P	MR-1.0-5.0 vario
US 3009-T09P	2.0	FLAG T09P	M 3	8.7	D-T9P	MR-1.0-5.0 vario
US 3508-T15P	3.0	FLAG T15P	M 3.5	8.3	D-T15P	MR-1.0-5.0 vario
US 3510-T15P	3.0	FLAG T15P	M 3.5	10.6	D-T15P	MR-1.0-5.0 vario
US 4011-T15P	3.5	FLAG T15P	M 4	10.7	D-T15P	MR-1.0-5.0 vario
US 5012-T15P	5.0	FLAG T15P	M 5	12.2	D-T15P	MR-1.0-5.0 vario



WMG (GRUPO DE MATERIAL)

GRUPO ISO	WMG (GRUPO DE MATERIAL)		Dureza (HB o HRC)	Resistencia Traccion (MPa)			
P	P1	P1.1	Sulfurizados	< 240 HB	≤ 830		
		P1.2	Acero facil mecanizado	Sulfurizados y fosforizados	< 180 HB	≤ 620	
		P1.3	(aceros al carbono con mayor maquinabilidad)	Sulfurizados/fosforizados y al plomo	< 180 HB	≤ 620	
	P2	P2.1	ACEROS AL CARBONO (aceros compuestos principalmente de hierro y carbono)	Contiene < 0.25 % C	< 180 HB	≤ 620	
		P2.2		Contiene < 0.55 % C	< 240 HB	≤ 830	
		P2.3		Contiene > 0.55 % C	< 300 HB	≤ 1030	
	P3	P3.1	ACEROS ALEADOS (aceros al carbono con un contenido de aleación del 10 %)	Recocido	< 180 HB	≤ 620	
		P3.2		Templado y endurecido	180 – 260 HB	> 620 ≤ 900	
		P3.3			260 – 360 HB	> 900 ≤ 1240	
	P4	P4.1	ACERO DE HERRAMIENTAS (aleaciones especiales para herramientas, moldes y matrices)	Recocido	< 26 HRC	≤ 900	
		P4.2		Templado y endurecido	26 – 39 HRC	> 900 ≤ 1240	
		P4.3			39 – 45 HRC	> 1240 ≤ 1450	
M	M1	M1.1	ACERO INOXIDABLE FERRITICO (aleaciones al cromo no endurecidas)	< 160 HB	≤ 520		
		M1.2		160 – 220 HB	> 520 ≤ 700		
	M2	M2.1	ACERO INOXIDABLE MARTENSITICO (aleaciones al cromo endurecidas)	Recocido	< 200 HB	≤ 670	
		M2.2		Enfriadas y templadas	200 – 280 HB	> 670 ≤ 950	
		M2.3		Templado por precipitacion	280 – 380 HB	> 950 ≤ 1300	
	M3	M3.1	ACERO INOXIDABLE AUSTENITICO (aleaciones cromo - níquel y cromo - níquel - manganeso)	< 200 HB	≤ 750		
		M3.2		200 – 260 HB	> 750 ≤ 870		
		M3.3		260 – 300 HB	> 870 ≤ 1040		
	M4	M4.1	AUTENITICO-FERRITICO (DUPLEX) O ACERO INOXIDABLE SUPER AUSTENITICO	< 300 HB	≤ 990		
		M4.2	ACEROS INOXIDABLE AUSTENITICOS ENDURECIDOS POR PRECIPITACION	300 – 380 HB	≤ 1320		
	K	K1	K1.1	FUNDICION GRIS (ASTM A48) O FUNDICION GRIS AUTOMOCION (ASTM A159) (fundicion hierro - carbono con micro estructura de grafito laminar)	Ferrítica o ferrítica-perlítica	< 180 HB	≤ 190
			K1.2		Ferrítica-perlítica o perlítica	180 – 240 HB	> 190 ≤ 310
K1.3			Perlítica		240 – 280 HB	> 310 ≤ 390	
K2		K2.1	FUNDICION MALEABLE (ASTM A602) (fundición de hierro-carbono con una microestructura libre de grafito)	Ferrítica	< 160 HB	≤ 400	
		K2.2		Ferrítica o perlítica	160 – 200 HB	> 400 ≤ 550	
		K2.3		Perlítica	200 – 240 HB	> 550 ≤ 660	
K3		K3.1	FUNDICION DÚCTIL (ASTM A536) (fundición de hierro-carbono con microestructura de grafito nodular)	Ferrítica	< 180 HB	≤ 560	
		K3.2		Ferrítica o perlítica	180 – 220 HB	> 560 ≤ 680	
		K3.3		Perlítica	220 – 260 HB	> 680 ≤ 800	
K4		K4.1	FUNDICION GRIS AUSTENITICO (ASTM A436) (fundiciones de aleación de hierro-carbono con microestructura de grafito laminar austenítico)	< 180 HB	≤ 190		
		K4.2	FUNDICION DÚCTIL AUSTENITICA (ASTM A439 o ASTM A571) (fundiciones de hierro-carbono con microestructura de grafito nodular austenítico)	< 240 HB	≤ 740		
				< 280 HB	> 840 ≤ 980		
		K4.3	FUNDICION DÚCTIL AUSTEMPERADA (ASTM A897) (fundiciones de hierro y carbono con microestructura de ausferrita)	280 – 320 HB	> 980 ≤ 1130		
		K4.4		320 – 360 HB	> 1130 ≤ 1280		
		K4.5		< 180 HB	≤ 400		
K5	K5.1	FUNDICION DE GRAFITO COMPACTADO CGI (ASTM A842) (fundición de hierro-carbono con estructura vermicular de grafito)	Ferrítico	< 180 HB	≤ 400		
	K5.2		Ferrítico-perlítico	180 – 220 HB	> 400 ≤ 450		
	K5.3		Perlítico	220 – 260 HB	> 450 ≤ 500		
N	N1	N1.1	Aluminio forjado comercialmente puro	< 60 HB	≤ 240		
		N1.2		Templado medio	60 – 100 HB	> 240 ≤ 400	
		N1.3		Templado completo	100 – 150 HB	> 400 ≤ 590	
	N2	N2.1	Fundicion de aluminio	< 75 HB	≤ 240		
		N2.2		75 – 90 HB	> 240 ≤ 270		
		N2.3		90 – 140 HB	> 270 ≤ 440		
	N3	N3.1	Aleaciones de cobre de facil mecanizacion	-	-		
		N3.2	Aleaciones de cobre de viruta corta con maquinabilidad moderada	-	-		
		N3.3	Cobre electrolítico y aleaciones de cobre de viruta larga con baja maquinabilidad	-	-		
	N4	N4.1	Polimeros termoplasticos	-	-		
		N4.2	Polimeros termoendurecibles	-	-		
		N4.3	Composites o polimeros reforzados	-	-		
	N5	N5.1	Grafito	-	-		
	S	S1	S1.1	Titanio o aleaciones de titanio	< 200 HB	≤ 660	
			S1.2		200 – 280 HB	> 660 ≤ 950	
S1.3			280 – 360 HB		> 950 ≤ 1200		
S2		S2.1	Aleaciones termostresistentes con base hierro	< 200 HB	≤ 690		
		S2.2		200 – 280 HB	> 690 ≤ 970		
S3		S3.1	Aleaciones termostresistentes con base níquel	< 280 HB	≤ 940		
		S3.2		280 – 360 HB	> 940 ≤ 1200		
S4		S4.1	Aleaciones termostresistentes con base cobalto	< 240 HB	≤ 800		
	S4.2	240 – 320 HB		> 800 ≤ 1070			
H	H1	H1.1	Fundicion en frio	< 440 HB	-		
	H2	H2.1	Fundiciones templadas	< 55 HRC	-		
		H2.2		> 55 HRC	-		
	H3	H3.1	Aceros templados < 55 HRC	< 51 HRC	-		
		H3.2		51 – 55 HRC	-		
	H4	H4.1	Acero templados > 55 HRC	55 – 59 HRC	-		
		H4.2		> 59 HRC	-		



TABLA DE CONVERSIÓN DE DUREZA

Resistencia (MPa)	Dureza			
	BRINELL	VICKERS	ROCKWELL	ROCKWELL
R_m	HB	HV	HRB	HRC
285	86	90	1190	–
320	95	100	56.2	–
350	105	110	62.3	–
385	114	120	66.7	–
415	124	130	71.2	–
450	133	140	75.0	–
480	143	150	78.7	–
510	152	160	81.7	–
545	162	170	85.8	–
575	171	180	87.1	–
610	181	190	89.5	–
640	190	200	91.5	–
675	199	210	93.5	–
705	209	220	95	–
740	219	230	96.7	–
770	228	240	98.1	–
800	238	250	99.5	–
820	242	255	–	23.1
850	252	265	–	24.8
880	261	275	–	26.4
900	266	280	–	27.1
930	276	290	–	28.5
950	280	295	–	29.2
995	295	310	–	31.0
1030	304	320	–	32.2
1060	314	330	–	33.3
1095	323	340	–	34.4
1125	333	350	–	35.5
1155	342	360	–	36.6

Resistencia (MPa)	Dureza			
	BRINELL	VICKERS	ROCKWELL	ROCKWELL
R_m	HB	HV	HRB	HRC
1190	352	370	–	37.7
1220	361	380	–	38.8
1255	371	390	–	39.8
1290	380	400	–	40.8
1320	390	410	–	41.8
1350	399	420	–	42.7
1385	409	430	–	43.6
1420	418	440	–	44.5
1455	428	450	–	45.3
1485	437	460	–	46.1
1520	447	470	–	46.9
1555	456	480	–	47.7
1595	466	490	–	48.4
1630	475	500	–	49.1
1665	485	510	–	49.8
1700	494	520	–	50.5
1740	504	530	–	51.1
1775	513	540	–	51.7
1810	523	550	–	52.3
1845	532	560	–	53.0
1880	542	570	–	53.6
1920	551	580	–	54.1
1955	561	590	–	54.7
1995	570	600	–	55.2
2030	580	610	–	55.7
2070	589	620	–	56.3
2105	599	630	–	56.8
2145	608	640	–	57.3
2180	618	650	–	57.8

SIMPLY RELIABLE

Como profesional se puede juzgar la calidad del trabajo sólo mirando la viruta. Nuestra viruta es una forma limpia y sin complicaciones que en sí misma cuenta una historia. Es una señal clara y consistente y es por eso que la usamos como un símbolo por ser **Simplemente Fiables**.

DORMER PRAMET

www.dormerpramet.com



**CONTACTO DEL SOPORTE
DE VENTAS LOCAL
¡SIEMPRE ACTUALIZADO!**



DP-CAT-HOLEMAKING-2024-ES

FOLLOW US...



ONLINE



SEGMENTS



LIBRARY APP.



CALCULATOR APP.

