

DORMER  PRAMET

TURNING

2024



TURNING – GENERAL CONTENT

ISO TURNING	Positive inserts	Chip-breakers navigators	P	M	K	N	S	H		6	
			Fine-finishing FF2 SF3 AL SF3 SF3 J. NF1 FF2 SF3 SF2								13
			Finishing FM NF2 UR AL UR W FM FM NF2 .CMW								33
			Medium FM2 SI RF AL .CMW								49
			Roughing RM RM AL RM RM3								61
			Heavy roughing OR OR DR4								67
	TOOLS	by insert shape									69
		by clamping style	External: Internal: PSC:								154
	Negative inserts	Chip-breakers navigators	P	M	K	N	S	H			160
			Fine-finishing NF NF FF FF SF SF								167
Finishing FM SF FM SF W .NMA										175	
Medium SM NMR M SM .NMA M SI NM SF										187	
Roughing RM NRM KR NRM R R SF										213	
Heavy roughing OR NR2 HR2 NR2 HR 923										229	
TOOLS	by insert shape									240	
	by clamping style	External: Internal: PSC:								322	
	Other carbide & cermet inserts									327	
	Advanced materials inserts	CER (ISO-K)	PCD (ISO-N)	CBN (ISO-H)						336	
GROOVING & PARTING-OFF	External grooving and parting-off	GL	LCMF							355	
	Blades and modular blades	GL	LFMX	LFUX						381	
	Face grooving	GL	LFMX							401	
	Internal grooving	GL	LCMF 13							411	
	O-ring and circlips grooving		X61							419	
THREAD TURNING		Threading inserts and tools								429	
BROACHING & TOOL BITS		Keyway slotting tools and HSS-E tool bits								461	
INSTRUCTIONS	How to read catalogue data? (ISO 13399, icons, navigation...)								472		
	Grades navigator and detail description								492		
	Turning – technical info								497		
	Machining formulas, corrections and technical details								505		
	Workpiece material groups (WMG)								510		

PRODUCT FAMILY		PRODUCT FAMILY		PRODUCT FAMILY		PRODUCT FAMILY	
C		DTFN(RL) INT	306	PDJN(RL) EXT	264	SEUP(RL) INT	107
C.-DCLN(RL) EXT	254	DTGN(RL) EXT	300	PDNN(RL) EXT	265	SEXP(RL)-E INT	109
C.-DCLN(RL) INT	262	DU, D	399	PDUN(RL) INT	271	SEXP(RL) INT	108
C.-DDJN(RL) EXT	267	DVJN(RL) EXT	309	PDXN(RL) EXT	266	SI(RL)	457
C.-DDNN EXT	268	DVPN(RL) EXT	310	PHZ	462	SI(RL)-S	459
C.-DDUN(RL) EXT	269	DVUN(RL) INT	313	PHZ-2	463	SRDCN EXT	113
C.-DDUN(RL) INT	272	DWLN(RL) EXT	314	PLBN(RL) EXT	274	SRDC(RL) EXT	112
C.-DRSN(RL) EXT	279	DWLN(RL) INT	319	PRDCN EXT	110	SRS(C) EXT	114
C.-DSDNN EXT	291	G		PRSC(RL) EXT	111	SSBC(RL) EXT	119
C.-DSKN(RL) EXT	292	GFI(RL) EXT	372	PRSN(RL) EXT	278	SSDCN EXT	120
C.-DSRN(RL) EXT	293	GFM(RL) EXT	374	PSBN(RL) EXT	285	SSKC(RL) EXT	121
C.-DSSN(RL) EXT	294	GG.(RL) INT	415	PSDNN EXT	287	SSSC(RL) INT	122
C.-DTFN(RL) INT	308	GLAF(RL) EXT	356	PSKN(RL) EXT	288	STAC(RL) EXT	125
C.-DTJN(RL) EXT	305	GLAF(RL) EXT-S	358	PSKN(RL) INT	298	STFC(RL)-A EXT	127
C.-DVJN(RL) EXT	312	GLAG (RL) INT	412	PSSN(RL) EXT	290	STFC(RL)-E INT	131
C.-DWLN(RL) EXT	318	GLS B	382	PTFN(RL) EXT	302	STFC(RL) EXT	126
C.-DWLN(RL) INT	321	GLS BS	383	PTFN(RL) INT	307	STFC(RL) INT	129
C.-SCLC(RL) EXT	83	GLSF L-R AXIAL	402	PTGN(RL) EXT	303	STJC(RL) EXT	128
C.-SCLC(RL) INT	89	GLSF R-L AXIAL	403	PTTN(RL) EXT	304	SVAC(RL)-DC EXT	145
C.-SDJC(RL) EXT	96	GLSF(RL) EXT	359	PWLN(RL) EXT	317	SVHB(C)(RL) EXT	132
C.-SDNCN EXT	97	GLSF(RL) EXT-G	362	PWLN(RL) INT	320	SVJB(C)(RL) EXT	133
C.-SDUC(RL) INT	102	GLSF(RL) EXT-S	361	S		SVJB(RL) INT	141
C.-SRDCN EXT	116	GLSG R-R AXIAL	405	SCAC(RL) EXT	77	SVJC(RL)-DC EXT	146
C.-SVHB(RL) EXT	138	H		SCBC(RL) EXT	78	SVLC(RL) INT	147
C.-SVJB(RL) EXT	139	HOSE SET	366	SCDCR EXT	79	SVPB(C)(RL) EXT	135
C.-SVQB(RL) INT	144	K		SCFC(RL) EXT	80	SVQB(C)(RL) INT	142
C.-SVVBN EXT	140	KHP-CBN(RL)	256	SCFC(RL) INT	84	SVUB(C)(RL) INT	143
CKJN(RL) EXT	273	KHP-CLN(RL)	257	SCKC(RL) INT	85	SVVB(C)N EXT	136
D		KHP-LBN(RL)	275	SCLC(RL) EXT	81	SVXB(C)(RL) EXT	137
DCBN(RL) EXT	246	KHP-RSC(RL)	117	SCLC(RL) INT	86	SVXC(RL)-E INT	149
DCKN(RL) EXT	248	KHP-SBN(RL)	295	SCXC(RL) INT	88	SVXC(RL) INT	148
DCLN(RL) EXT	249	KHP-SSN(RL)	296	SDFC(RL) EXT	90	SWLC(RL) EXT	150
DCLN(RL) INT	259	KHS-SBC(RL)	123	SDJC(RL) EXT	91	SWLC(RL) INT	151
DDJN(RL) EXT	263	M		SDNCN EXT	93	SWUC(RL)-E INT	153
DDUN(RL) INT	270	MS-EN	398	SDQC(RL) INT	98	SWUC(RL) INT	152
	118	MTJN(RL) EXT	301	SDUCL EXT	94	T	
	124	MVJN(RL) EXT	311	SDUC(RL)-E INT	100	TOOL BITS F	466
DKH(RL)	258	MWLN(RL) EXT	316	SDUC(RL) INT	99	TOOL BITS R	467
	276	P		SDXC(RL) EXT	95	TOOL BITS S	468
	297	P61(RL) EXT	420	SDZC(RL) INT	101	TOOL BITS SA	469
DRSN(RL) EXT	277	P61(RL) INT	421	SEGC(RL) EXT	103	X	
DSBN(RL) EXT	280	P61S(RL)-1 INT	424	SELP(RL)-E INT	106	XLCFN B	390
DSDNN EXT	281	PCBN(RL) EXT	251	SELP(RL) INT	105	XLCFN B LFUX	396
DSKN(RL) EXT	282	PCKN(RL) EXT	252	SE(RL)	455	XLCF(NRL) BS	391
DSSN(RL) EXT	283	PCLN(RL) EXT	253	SE(RL)-S	456	XLXFL BS AXIAL	407
DTFN(RL) EXT	299	PCLN(RL) INT	260	SEUC(RL) INT	104		

PRODUCT FAMILY		PRODUCT FAMILY		PRODUCT FAMILY		PRODUCT FAMILY	
923	238	DNMG	177	SNMG	208	CCMT	66
CNMM	239	SNMG	178	TNMG	208	RCMT	66
SNMM	238	TNMG	179	VNMG	208	SCMT	66
.CMW	58	VNMG	179	WNMG	209	TCMT	66
CCMW	59	WNMG	180	NMR	202	SF	181
DCMW	59	FM2	50	CNMG	202	CNGG	182
ECMW	59	CCMT	51	DNMG	203	CNMG	182
RCMW	59	DCMT	51	SNMG	204	DNMG	182
SCMW	60	ECMT	52	TNMG	204	SNMG	183
TCMW	60	SCMT	52	VNMG	205	TNMG	183
VCGW	60	TCMT	52	WNMG	205	VNMG	184
VCMW	60	VBMT	53	NR2	233	WNMG	184
.NMA/NMA..S	210	VCGT	53	CNMM	234	SF2	25
CNMA	211	HR	236	DNMM	234	ECGT	25
DNMA	211	CNMM	237	SNMM	235	VCGT	25
SNMA	211	SNMM	237	TNMM	235	SF3	19
TNMA	212	TNMM	237	WNMM	235	CCGT	20
WNMA	212	HR2	238	NRM	223	DCGT	20
AL	26	CNMM	239	CNMG	224	ECGT	21
CCGT	27	SNMM	239	CNMM	224	SCGT	21
DCGT	27	JZ / JQ / JR	29	DNMG	224	TCGT	21
RCGT	27	CPGX	30	SNMG	225	VCGT	22
SCGT	27	EPGX	30	SNMM	225	SI	54
TCGT	28	TPGX	30	WNMG	225	CCGT	54
VCGT	28	WCGX	31	OR	68	DCGT	55
WCGT	28	KR	226	SCMT	68	TCGT	55
DR4	68	CNMG	227	OR	230	SI	198
SCMT	68	DNMG	227	CNMM	231	CNMG	199
FF	172	SNMG	227	DNMM	231	DNMG	199
CNMG	173	TNMG	227	SNMM	232	TNMG	200
DNMG	173	WNMG	227	TNMM	232	WNMG	201
TNMG	173	M	193	WNMM	232	SM	188
VNMG	173	CNMG	194	R	220	CNMG	189
WNMG	173	DNMG	195	CNMG	221	DNMG	190
FF2	14	SNMG	196	DNMG	221	SNMG	190
CCGT	15	TNMG	196	SNMG	221	TNMG	191
CCMT	15	VNMG	196	TNMG	222	VNMG	191
DCGT	15	WNMG	197	WNMG	222	WNMG	192
DCMT	15	NF	168	RF	56	UR	42
SCMT	16	CNMG	169	CCMT	57	CCMT	43
TCGT	16	DNMG	169	DCMT	57	DCMT	44
TCMT	16	SNMG	170	SCMT	57	RCMT	44
VBMT	17	TNMG	170	TCMT	57	SCMT	45
VCGT	17	VNMG	171	WCMT	57	TCMT	45
VCGX	17	WNMG	171	RM	62	VBMT	46
WCGT	18	NF1	23	CCMT	63	VCMT	46
FM	34	CCGT	24	DCMT	63	WCMT	46
CCMT	35	DCGT	24	SCMT	64	W-FM / W-UR	47
DCMT	36	TCGT	24	TCMT	64	CCMT	47
RCMT	37	SCGT	24	VBMT	64	DCMX	47
SCMT	37	NF2	40	RM	214	W-M / W-MR	185
TCMT	38	CCMT	40	CNMG	215	CNMG	186
VBMT	38	EPMT	41	DNMG	216	DNMG	186
VCMT	39	VCGT	41	SNMG	217	WNMG	186
WCMT	39	NM	206	TNMG	218		
FM	176	CNMG	207	WNMG	219		
CNMG	177	DNMG	207	RM3	65		

INDEXABLE INSERTS – CONTENT (ALPHABETICAL)

PRODUCT FAMILY		PRODUCT FAMILY		PRODUCT FAMILY		PRODUCT FAMILY	
C		L		SPUN-IT		TNMM	
CCGW CBN	347	LCMF 13 – CM	416		336	TN NPT EXT	334
CNGA CBN	348	LCMF 13 – F	416	T		TN NPT EXT – P1	445
CNGA CER	340	LCMF 13 – MP	417	TCGW CBN	349	TN NPT INT	446
CNGN CER	340	LCMF 16 – CM	375	TN 55° PP EXT	444	TN NPT INT – P1	435
DCGW CBN	348	LCMF 16, LCMF 30 – F	376	TN 55° PP EXT – P1	434	TN RD EXT	452
DCMW PCD	346	LCMF 16, LCMF 30 – MP	377	TN 55° PP INT	444	TN RD INT	452
DNGA CBN	349	LCMF 16 – M	377	TN 55° PP INT – P1	434	TN STACME INT	450
DNGA CER	341	LCMR 16 – CM	378	TN 60° PP EXT	440	TN TR EXT	448
DNGN CER	341	LCMR 16, LCMR 30 – F	378	TN 60° PP EXT – P1	432	TN TR INT	449
G		LCMR 16 – M	379	TN 60° PP INT	441	TN TR-S EXT	446
	370	LCMR 16 – MP	379	TN 60° PP INT – P1	432	TN TR-S INT	447
GL. D – GM	387	LFMX – F1	392	TN 60°-S PP EXT	447	TN UN EXT	438
	406		408	TN 60°-S PP INT	448	TN UN EXT – P1	431
	414	LFMX – F2	392	TN ACME EXT	449	TN UN INT	439
	370		408	TN ACME INT	450	TN UN INT – P1	431
GL. D – MM	387	LFMX – M2	393	TN API RD EXT	453	TN W EXT	442
	406		409	TN API RD INT	453	TN W EXT – P1	433
	414	LFUX	397	TN BSPT EXT	451	TN W INT	443
	367	LNFX 40, LN.X 50	329	TN BSPT INT	451	TN W INT – P1	433
GL. D – PM	384	R		TNGA CBN	350	TPGN CER	345
	368	RCGX CER	342	TNGA CER	344	TPMR	335
GL. D – PR	385	RCMT	330	TNGN CER	345	TPUN-IT	337
	369	RCMX	331	TNMA	210	V	
GL. S – PM	386	RNGN CER	342	TN M EXT	436	VBGW CBN	350
	369	RNMG	333	TN M EXT	454	VCMW PCD	347
GL. S – PR	386	SNGA CER	343	TN M EXT – P1	430	VNGA CBN	351
		SNGN CER	343	TN M INT	437	VNGA CER	346
H		SNMM	333	TN M INT	454	W	
HZ	464	SNMX	334	TN M INT – P1	430	WNGA CBN	351
HZ-2	465	SPGN CER	344	TNMM	230	X	
K		SPMR	335	TNMM	233	X 61	422
KNUX	328			TNMM	236	X 61 R	423
						X 61-1	425
						X 61 R-1	426

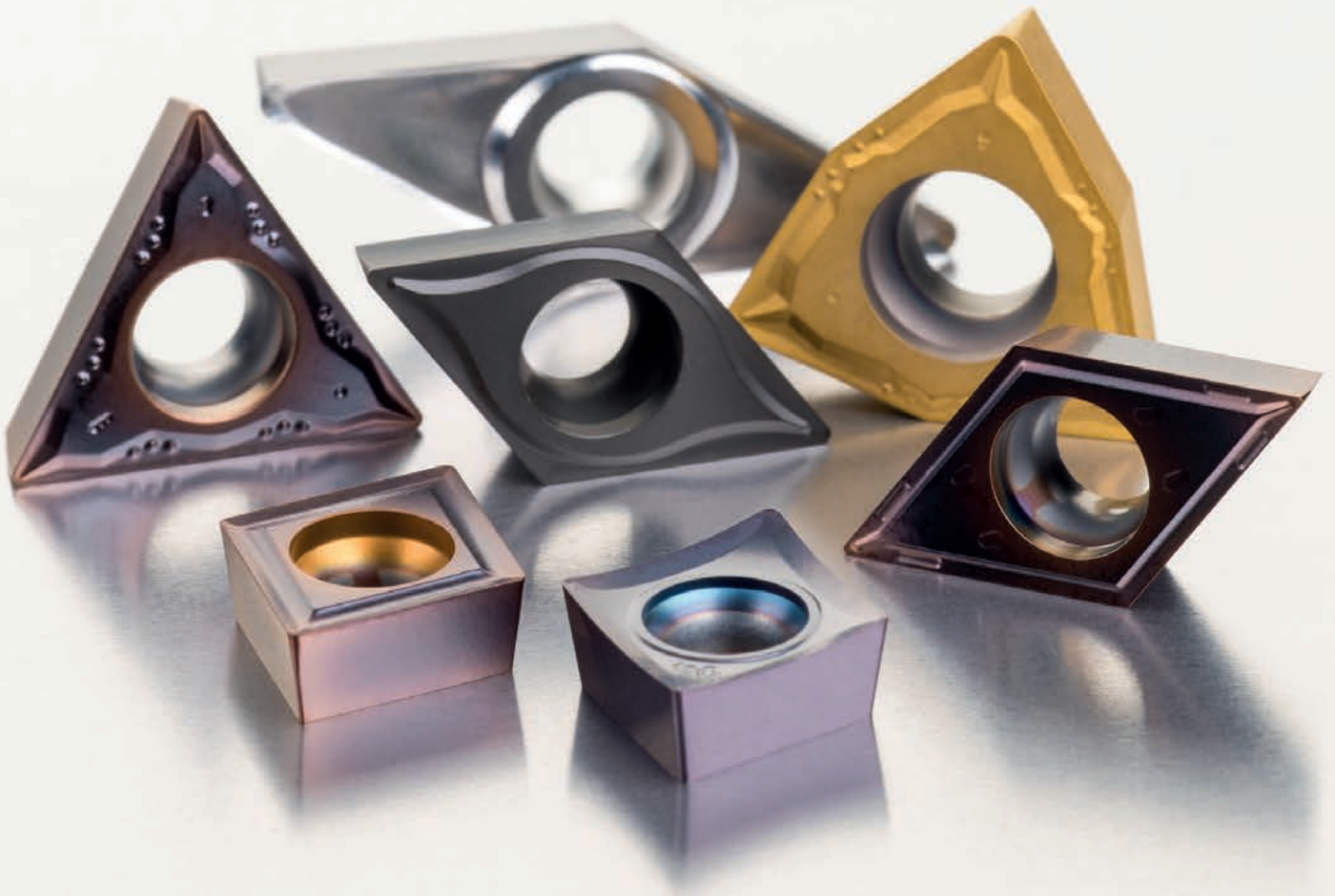

POSITIVE INSERTS

ISO INSERTS POSITIVE – CHIPBREAKER NAVIGATOR

P

Very unstable working conditions

Unstable working conditions

Stable working conditions

Thin-walled and slim workpieces

1st choice

 Possible use

RF

FF2

FM2

RM3

FF

UR

FM

RM

OR

DR4

SF3



	0.05 – 0.2 mm/rev	0.05 – 0.2 mm/rev	0.2 – 0.4 mm/rev	0.4 – 1.0 mm/rev	> 1.0 mm/rev
	0.05 – 2 mm	0.05 – 2 mm	2 – 4 mm	4 – 10 mm	> 10 mm

UR		Designed for fine to finish machining, steels and cast irons and potentially stainless steel, continuous and interrupted cuts
FM		Designed for finish to semi-rough machining, steels and stainless steels, potentially cast irons and non ferrous materials, continuous and moderately interrupted cuts
RM		Designed for semi-rough machining, steels, stainless steels and cast irons, potentially super alloys and hardened materials, continuous and interrupted cuts
OR		Designed for rough and heavy rough machining, steels, stainless steels and cast irons, potentially super alloys. continuous and interrupted cuts

ISO INSERTS POSITIVE – CHIPBREAKER NAVIGATOR

M

Very unstable working conditions

Unstable working conditions

Stable working conditions

Thin-walled and slim workpieces

1st choice

Possible use

NF1

FM2

RF

SF2

NF2

FM

RM

OR

DR4



	0.05 – 0.2 mm/rev	0.05 – 0.2 mm/rev	0.2 – 0.4 mm/rev	0.4 – 1.0 mm/rev	> 1.0 mm/rev
	0.05 – 2 mm	0.05 – 2 mm	2 – 4 mm	4 – 10 mm	> 10 mm

NF2		Positive design for fine-finish to semi rough machining, stainless steels and super alloys, continuous cuts
FM		Designed for finish to semi-rough machining, steels and stainless steels, potentially cast irons and non ferrous materials, continuous and moderately interrupted cuts
RM		Designed for semi-rough machining, steels, stainless steels and cast irons, potentially super alloys and hardened materials, continuous and interrupted cuts
OR		Designed for rough and heavy rough machining, steels, stainless steels and cast irons, potentially super alloys. continuous and interrupted cuts

ISO INSERTS POSITIVE – CHIPBREAKER NAVIGATOR

K

Very unstable working conditions

Unstable working conditions

Stable working conditions

Thin-walled and slim workpieces

1st choice
 Possible use

RM3

.CMW

OR

DR4

UR

RF

RM

SF3



	0.05 – 0.2 mm/rev	0.05 – 0.2 mm/rev	0.2 – 0.4 mm/rev	0.4 – 1.0 mm/rev	> 1.0 mm/rev
	0.05 – 2 mm	0.05 – 2 mm	2 – 4 mm	4 – 10 mm	> 10 mm

RF	<table border="1" style="font-size: small; margin-top: 5px;"> <tr><td>I.C.</td><td>R</td></tr> <tr><td>6,35</td><td>1,0</td></tr> <tr><td>9,525</td><td>1,5</td></tr> <tr><td>12,7</td><td>2,5</td></tr> </table>	I.C.	R	6,35	1,0	9,525	1,5	12,7	2,5	Designed for rough machining, cast irons, potentially steels, stainless steels and hard materials, continuous and interrupted cuts		
I.C.	R											
6,35	1,0											
9,525	1,5											
12,7	2,5											
RM		Designed for semi-rough machining, steels, stainless steels and cast irons, potentially super alloys and hardened materials, continuous and interrupted cuts										
OR		Designed for rough and heavy rough machining, steels, stainless steels and cast irons, potentially super alloys. continuous and interrupted cuts										

ISO INSERTS POSITIVE – CHIPBREAKER NAVIGATOR

N

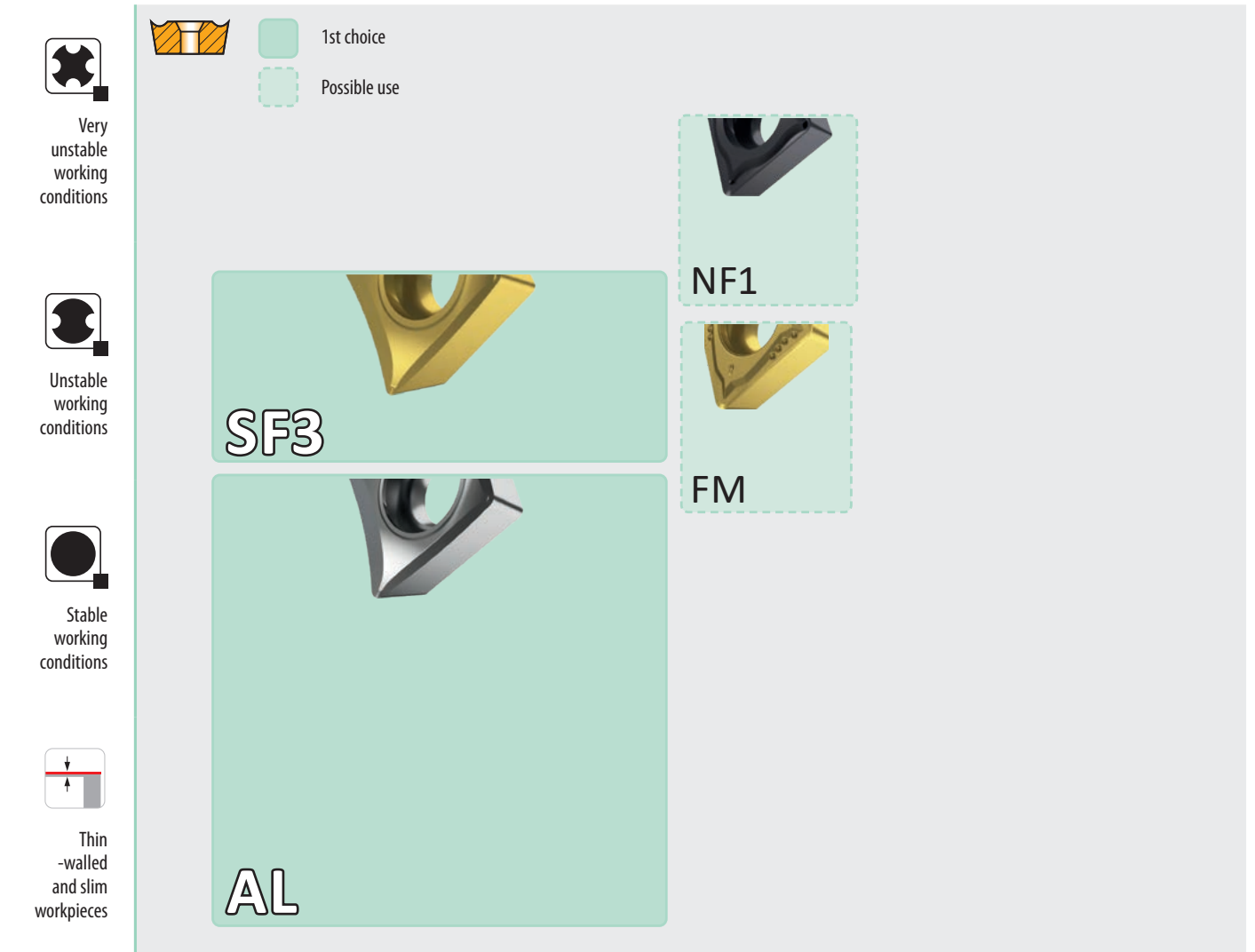

f	0.05 – 0.2 mm/rev	0.05 – 0.2 mm/rev	0.2 – 0.4 mm/rev	0.4 – 1.0 mm/rev	> 1.0 mm/rev
a_p	0.05 – 2 mm	0.05 – 2 mm	2 – 4 mm	4 – 10 mm	> 10 mm

SF3		Very positive design for fine and finish machining, super alloys, stainless steels and non ferrous materials, potentially steel, cast irons and hard materials, continuous cuts		
AL		Highly positive design for fine finish to rough machining, aluminium, aluminium alloys and other non ferrous materials, potentially super alloys, continuous cuts		

ISO INSERTS POSITIVE – CHIPBREAKER NAVIGATOR

S

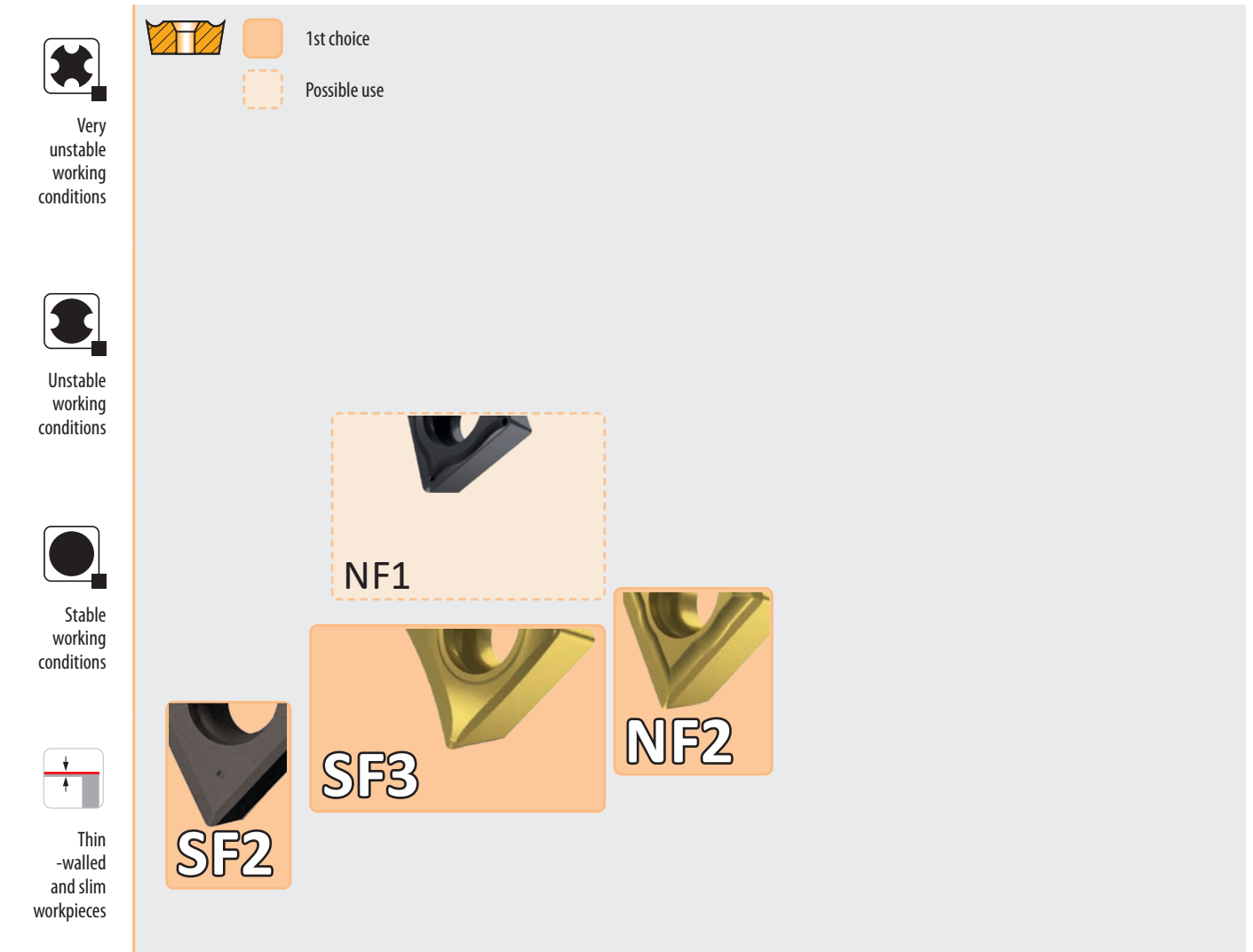

	0.05 – 0.2 mm/rev	0.05 – 0.2 mm/rev	0.2 – 0.4 mm/rev	0.4 – 1.0 mm/rev	> 1.0 mm/rev
	0.05 – 2 mm	0.05 – 2 mm	2 – 4 mm	4 – 10 mm	> 10 mm

SF2		Very positive design for fine and finish machining, super alloys, potentially stainless steels, steels and non ferrous materials, continuous cuts		
SF3		Very positive design for fine and finish machining, super alloys, stainless steels and non ferrous materials, potentially steel, cast irons and hard materials, continuous cuts		
NF2		Positive design for fine-finish to semi rough machining, stainless steels and super alloys, continuous cuts		

ISO INSERTS POSITIVE – CHIPBREAKER NAVIGATOR

H

Very unstable working conditions

Unstable working conditions

Stable working conditions

Thin-walled and slim workpieces

1st choice
 Possible use

RM3

NF1

.CMW

SF3

FF

F

M









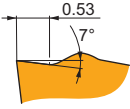
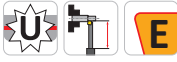
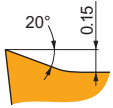

R

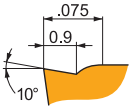
HR

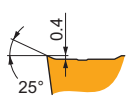
	0.05 – 0.2 mm/rev	0.05 – 0.2 mm/rev	0.2 – 0.4 mm/rev	0.4 – 1.0 mm/rev	> 1.0 mm/rev
	0.05 – 2 mm	0.05 – 2 mm	2 – 4 mm	4 – 10 mm	> 10 mm

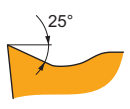
SF3		Very positive design for fine and finish machining, super alloys, stainless steels and non ferrous materials, potentially steel, cast irons and hard materials, continuous cuts
NF1		Positive design for fine-finish to medium machining, stainless steels and super alloys, potentially steels, non ferrous and hard materials, continuous cuts
.CMW		Designed for fine finish to semi rough machining, cast irons, potentially hard materials, continuous and slightly interrupted cuts
		RM3 Designed for rough machining, cast irons, potentially steels, stainless steels and hard materials, continuous and interrupted cuts

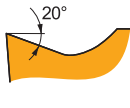
FINE-FINISHING – NAVIGATOR

FF2			<p>FF2 chip breaker is sharp and the first choice for fine-finishing of Steels. It features slightly positive rake angle without T-land. It's also suitable for Cast irons.</p>
SF3			<p>SF3 chip breaker is sharp and the first choice for fine-finishing of Stainless steels and Super-alloys. It features highly positive rake angle without T-land. It's also suitable for Non-ferrous alloys, and conditionally for Steels, Cast irons and Hard materials.</p>
NF1			<p>NF1 chip breaker is sharp and designed for fine-finishing of Steels, Stainless steels and Super-alloys. It features positive rake angle without T-land. It's also conditionally suitable for Non-ferrous alloys and Hard materials.</p>
SF2			<p>SF2 chip breaker is sharp and designed for fine-finishing of Stainless steels and Super-alloys. It features highly positive rake angle without T-land. It's also conditionally suitable for Steels and Non-ferrous alloys.</p>
AL			<p>AL chip breaker is sharp and the first choice for all-around machining of Non-ferrous alloys. It features highly positive rake angle without T-land. It's also conditionally suitable for Super-alloys.</p>
JQ JR JZ			<p>JQ chip breaker is sharp and designed for fine-finishing of Steels. It features highly positive rake angle without T-land. It's also conditionally suitable for Stainless steels.</p>

FF2

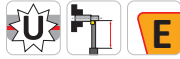
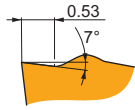

FF2 chip breaker is sharp and the first choice for fine-finishing of Steels. It features slightly positive rake angle without T-land. It's also suitable for Cast irons.



CCGT / CCMT

	IC (mm)	D1 (mm)	L (mm)	S (mm)
0602	6.350	2.80	6.40	2.38
0803	7.940	3.40	8.10	3.18
09T3	9.525	4.40	9.70	3.97

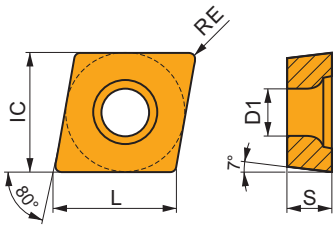

DCGT / DCMT

	IC (mm)	D1 (mm)	L (mm)	S (mm)
0702	6.350	2.80	7.80	2.38
11T3	9.525	4.40	11.60	3.97

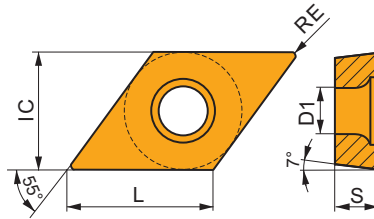

SCMT

	IC (mm)	D1 (mm)	L (mm)	S (mm)
09T3	9.525	4.40	9.53	3.97

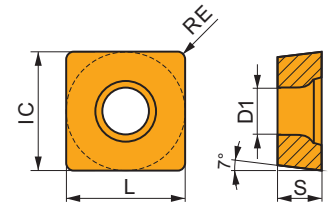

TCGT / TCMT

	IC (mm)	D1 (mm)	L (mm)	S (mm)
06T1	3.970	2.20	6.90	1.98
0902	5.560	2.50	9.60	2.38
1102	6.350	2.80	11.00	2.38
16T3	9.525	4.40	16.50	3.97

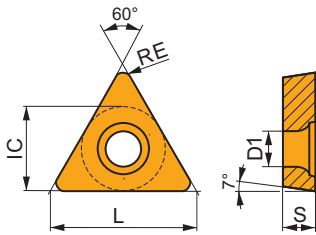

VBMT

	IC (mm)	D1 (mm)	L (mm)	S (mm)
1604	9.525	4.40	16.60	4.76

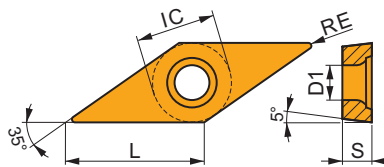

VCGT

	IC (mm)	D1 (mm)	L (mm)	S (mm)
0702	3.970	2.20	6.90	2.38
1303	7.940	3.40	13.80	3.18

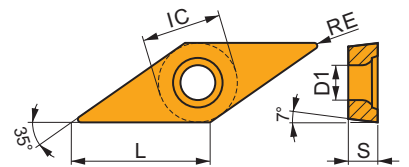

VCGX

	IC (mm)	D1 (mm)	L (mm)	S (mm)
1303	7.940	3.40	13.80	3.18

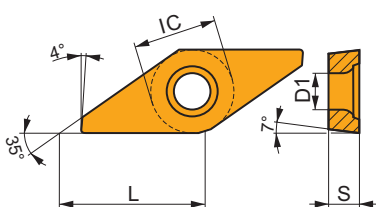

WCGT

	IC (mm)	D1 (mm)	L (mm)	S (mm)
0201	3.970	2.20	2.70	1.59

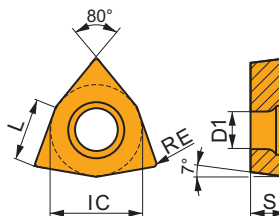

Suitability and starting values for cutting speed (vc), feed (f) and depth of cut (ap). Refer to our Machining Calculator app for further calculations.

Product	RE (mm)	P			M			K			N			S			H		
		vc (m/min)	f (mm/rev)	ap (mm)	vc (m/min)	f (mm/rev)	ap (mm)	vc (m/min)	f (mm/rev)	ap (mm)	vc (m/min)	f (mm/rev)	ap (mm)	vc (m/min)	f (mm/rev)	ap (mm)	vc (m/min)	f (mm/rev)	ap (mm)

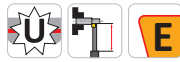
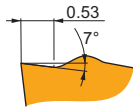

FF2 chip breaker is sharp and the first choice for fine-finishing of Steels. It features slightly positive rake angle without T-land. It's also suitable for Cast irons.

CCGT 09T302E-FF2:T9325	● 0.2	■ 345	0.05	1.0	—	—	—	■ 325	0.05	1.0	—	—	—	—	—	—	—	—	—
------------------------	-------	-------	------	-----	---	---	---	-------	------	-----	---	---	---	---	---	---	---	---	---

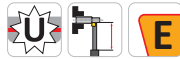
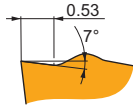
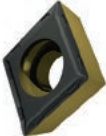

FF2 chip breaker is sharp and the first choice for fine-finishing of Steels. It features slightly positive rake angle without T-land. It's also suitable for Cast irons.

CCMT 060202E-FF2:T8430	● 0.2	■ 280	0.05	0.8	—	—	—	■ 230	0.05	0.8	—	—	—	—	—	—	—	—	—
CCMT 060202E-FF2:T9325	● 0.2	■ 350	0.05	0.8	—	—	—	■ 330	0.05	0.8	—	—	—	—	—	—	—	—	—
CCMT 060202E-FF2:T9415	● 0.2	■ 395	0.05	0.8	—	—	—	■ 375	0.05	0.8	—	—	—	—	—	—	—	—	—
CCMT 060202E-FF2:TT010	● 0.2	■ 345	0.05	0.5	—	—	—	—	—	—	—	—	—	—	—	—	—	—	—
CCMT 060204E-FF2:T7325	● 0.4	■ 190	0.12	1.0	—	—	—	—	—	—	—	—	—	—	—	—	—	—	—
CCMT 060204E-FF2:T8430	● 0.4	■ 205	0.12	1.0	—	—	—	■ 170	0.12	1.0	—	—	—	—	—	—	—	—	—
CCMT 060204E-FF2:T9325	● 0.4	■ 255	0.12	1.0	—	—	—	■ 240	0.12	1.0	—	—	—	—	—	—	—	—	—
CCMT 060204E-FF2:T9335	● 0.4	■ 215	0.12	1.0	—	—	—	—	—	—	—	—	—	—	—	—	—	—	—
CCMT 060204E-FF2:T9415	● 0.4	■ 305	0.12	1.0	—	—	—	■ 285	0.12	1.0	—	—	—	—	—	—	—	—	—
CCMT 060204E-FF2:TT010	● 0.4	■ 280	0.12	0.5	—	—	—	—	—	—	—	—	—	—	—	—	—	—	—
CCMT 080302E-FF2:T8430	● 0.2	■ 280	0.05	0.8	—	—	—	■ 230	0.05	0.8	—	—	—	—	—	—	—	—	—
CCMT 080302E-FF2:T9325	● 0.2	■ 350	0.05	0.8	—	—	—	■ 330	0.05	0.8	—	—	—	—	—	—	—	—	—
CCMT 080304E-FF2:T7325	● 0.4	■ 190	0.12	1.0	—	—	—	—	—	—	—	—	—	—	—	—	—	—	—
CCMT 080304E-FF2:T8430	● 0.4	■ 205	0.12	1.0	—	—	—	■ 170	0.12	1.0	—	—	—	—	—	—	—	—	—
CCMT 080304E-FF2:T9325	● 0.4	■ 255	0.12	1.0	—	—	—	■ 240	0.12	1.0	—	—	—	—	—	—	—	—	—
CCMT 080304E-FF2:TT010	● 0.4	■ 350	0.06	0.5	—	—	—	—	—	—	—	—	—	—	—	—	—	—	—
CCMT 080308E-FF2:T8430	● 0.8	■ 210	0.17	1.0	—	—	—	■ 175	0.17	1.0	—	—	—	—	—	—	—	—	—
CCMT 080308E-FF2:T9325	● 0.8	■ 260	0.17	1.0	—	—	—	■ 245	0.17	1.0	—	—	—	—	—	—	—	—	—
CCMT 09T304E-FF2:T8430	● 0.4	■ 200	0.12	1.2	—	—	—	■ 165	0.12	1.2	—	—	—	—	—	—	—	—	—
CCMT 09T304E-FF2:T9325	● 0.4	■ 250	0.12	1.2	—	—	—	■ 235	0.12	1.2	—	—	—	—	—	—	—	—	—
CCMT 09T304E-FF2:T9335	● 0.4	■ 215	0.12	1.2	—	—	—	—	—	—	—	—	—	—	—	—	—	—	—
CCMT 09T304E-FF2:T9415	● 0.4	■ 300	0.12	1.2	—	—	—	■ 285	0.12	1.2	—	—	—	—	—	—	—	—	—
CCMT 09T304E-FF2:TT010	● 0.4	■ 350	0.06	0.5	—	—	—	—	—	—	—	—	—	—	—	—	—	—	—
CCMT 09T308E-FF2:T8430	● 0.8	■ 205	0.17	1.2	—	—	—	■ 170	0.17	1.2	—	—	—	—	—	—	—	—	—
CCMT 09T308E-FF2:T9325	● 0.8	■ 255	0.17	1.2	—	—	—	■ 240	0.17	1.2	—	—	—	—	—	—	—	—	—
CCMT 09T308E-FF2:T9415	● 0.8	■ 300	0.20	1.2	—	—	—	■ 285	0.20	1.2	—	—	—	—	—	—	—	—	—
CCMT 09T308E-FF2:TT010	● 0.8	■ 350	0.10	0.8	—	—	—	—	—	—	—	—	—	—	—	—	—	—	—

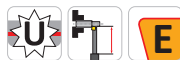
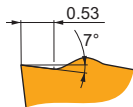

FF2 chip breaker is sharp and the first choice for fine-finishing of Steels. It features slightly positive rake angle without T-land. It's also suitable for Cast irons.

DCGT 11T302E-FF2:T8430	● 0.2	■ 225	0.05	0.8	—	—	—	■ 185	0.05	0.8	—	—	—	—	—	—	—	—	—
DCGT 11T302E-FF2:T9325	● 0.2	■ 280	0.05	0.8	—	—	—	■ 265	0.05	0.8	—	—	—	—	—	—	—	—	—
DCGT 11T302E-FF2:TT010	● 0.2	■ 275	0.05	0.5	—	—	—	—	—	—	—	—	—	—	—	—	—	—	—

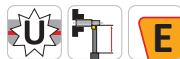
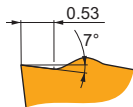

FF2 chip breaker is sharp and the first choice for fine-finishing of Steels. It features slightly positive rake angle without T-land. It's also suitable for Cast irons.

DCMT 070202E-FF2:T7325	● 0.2	■ 190	0.05	0.8	—	—	—	—	—	—	—	—	—	—	—	—	—	—	—
DCMT 070202E-FF2:T8430	● 0.2	■ 225	0.05	0.8	—	—	—	■ 185	0.05	0.8	—	—	—	—	—	—	—	—	—
DCMT 070202E-FF2:T9325	● 0.2	■ 280	0.05	0.8	—	—	—	■ 265	0.05	0.8	—	—	—	—	—	—	—	—	—
DCMT 070202E-FF2:TT010	● 0.2	■ 275	0.05	0.5	—	—	—	—	—	—	—	—	—	—	—	—	—	—	—
DCMT 070204E-FF2:T7325	● 0.4	■ 160	0.12	0.8	—	—	—	—	—	—	—	—	—	—	—	—	—	—	—
DCMT 070204E-FF2:T8430	● 0.4	■ 170	0.12	0.8	—	—	—	■ 135	0.12	0.8	—	—	—	—	—	—	—	—	—
DCMT 070204E-FF2:T9325	● 0.4	■ 205	0.12	0.8	—	—	—	■ 190	0.12	0.8	—	—	—	—	—	—	—	—	—
DCMT 070204E-FF2:T9415	● 0.4	■ 250	0.12	0.8	—	—	—	■ 235	0.12	0.8	—	—	—	—	—	—	—	—	—
DCMT 070208E-FF2:T7325	● 0.8	■ 170	0.17	0.8	—	—	—	—	—	—	—	—	—	—	—	—	—	—	—
DCMT 070208E-FF2:T8430	● 0.8	■ 175	0.17	0.8	—	—	—	■ 140	0.17	0.8	—	—	—	—	—	—	—	—	—
DCMT 070208E-FF2:T9325	● 0.8	■ 215	0.17	0.8	—	—	—	■ 200	0.17	0.8	—	—	—	—	—	—	—	—	—
DCMT 070208E-FF2:T9415	● 0.8	■ 265	0.17	0.8	—	—	—	■ 250	0.17	0.8	—	—	—	—	—	—	—	—	—

Suitability and starting values for cutting speed (vc), feed (f) and depth of cut (ap). Refer to our Machining Calculator app for further calculations.

Product	RE (mm)	P			M			K			N			S			H		
		vc (m/min)	f (mm/rev)	ap (mm)	vc (m/min)	f (mm/rev)	ap (mm)	vc (m/min)	f (mm/rev)	ap (mm)	vc (m/min)	f (mm/rev)	ap (mm)	vc (m/min)	f (mm/rev)	ap (mm)	vc (m/min)	f (mm/rev)	ap (mm)

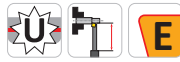
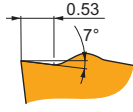
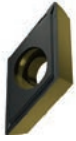

FF2 chip breaker is sharp and the first choice for fine-finishing of Steels. It features slightly positive rake angle without T-land. It's also suitable for Cast irons.

DCMT 11T304E-FF2:T7325	● 0.4	160	0.12	0.8	-	-	-	-	-	-	-	-	-	-	-	-	-	-
DCMT 11T304E-FF2:T8430	● 0.4	170	0.12	0.8	-	-	-	135	0.12	0.8	-	-	-	-	-	-	-	-
DCMT 11T304E-FF2:T9325	● 0.4	205	0.12	0.8	-	-	-	190	0.12	0.8	-	-	-	-	-	-	-	-
DCMT 11T304E-FF2:T9415	● 0.4	250	0.12	0.8	-	-	-	235	0.12	0.8	-	-	-	-	-	-	-	-
DCMT 11T304E-FF2:TT010	● 0.4	280	0.06	0.5	-	-	-	-	-	-	-	-	-	-	-	-	-	-
DCMT 11T308E-FF2:T7325	● 0.8	170	0.17	0.8	-	-	-	-	-	-	-	-	-	-	-	-	-	-
DCMT 11T308E-FF2:T8430	● 0.8	175	0.17	0.8	-	-	-	140	0.17	0.8	-	-	-	-	-	-	-	-
DCMT 11T308E-FF2:T9325	● 0.8	215	0.17	0.8	-	-	-	200	0.17	0.8	-	-	-	-	-	-	-	-
DCMT 11T308E-FF2:T9415	● 0.8	265	0.17	0.8	-	-	-	250	0.17	0.8	-	-	-	-	-	-	-	-
DCMT 11T308E-FF2:TT010	● 0.8	280	0.10	0.8	-	-	-	-	-	-	-	-	-	-	-	-	-	-

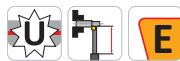
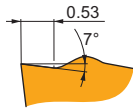
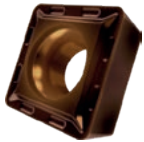

FF2 chip breaker is sharp and the first choice for fine-finishing of Steels. It features slightly positive rake angle without T-land. It's also suitable for Cast irons.

SCMT 09T304E-FF2:T8430	● 0.4	210	0.12	1.2	-	-	-	175	0.12	1.2	-	-	-	-	-	-	-	-
SCMT 09T304E-FF2:T9325	● 0.4	260	0.12	1.2	-	-	-	245	0.12	1.2	-	-	-	-	-	-	-	-
SCMT 09T308E-FF2:T8430	● 0.8	220	0.17	1.2	-	-	-	180	0.17	1.2	-	-	-	-	-	-	-	-
SCMT 09T308E-FF2:T9325	● 0.8	265	0.17	1.2	-	-	-	250	0.17	1.2	-	-	-	-	-	-	-	-

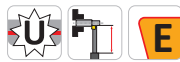
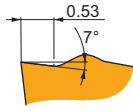

FF2 chip breaker is sharp and the first choice for fine-finishing of Steels. It features slightly positive rake angle without T-land. It's also suitable for Cast irons.

TCGT 06T102E-FF2:T8430	● 0.2	235	0.05	0.8	-	-	-	190	0.05	0.8	-	-	-	-	-	-	-	-
TCGT 06T102E-FF2:TT010	● 0.2	295	0.05	0.5	-	-	-	-	-	-	-	-	-	-	-	-	-	-
TCGT 090202E-FF2:TT010	● 0.2	295	0.05	0.5	-	-	-	-	-	-	-	-	-	-	-	-	-	-

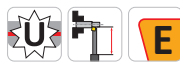
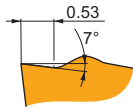

FF2 chip breaker is sharp and the first choice for fine-finishing of Steels. It features slightly positive rake angle without T-land. It's also suitable for Cast irons.

TCMT 06T102E-FF2:T8430	● 0.2	235	0.05	0.8	-	-	-	190	0.05	0.8	-	-	-	-	-	-	-	-
TCMT 06T102E-FF2:T9415	● 0.2	335	0.05	0.8	-	-	-	315	0.05	0.8	-	-	-	-	-	-	-	-
TCMT 06T104E-FF2:T7325	● 0.4	170	0.12	0.8	-	-	-	-	-	-	-	-	-	-	-	-	-	-
TCMT 06T104E-FF2:T8430	● 0.4	180	0.12	0.8	-	-	-	145	0.12	0.8	-	-	-	-	-	-	-	-
TCMT 06T104E-FF2:T9325	● 0.4	220	0.12	0.8	-	-	-	205	0.12	0.8	-	-	-	-	-	-	-	-
TCMT 06T104E-FF2:T9415	● 0.4	265	0.12	0.8	-	-	-	250	0.12	0.8	-	-	-	-	-	-	-	-
TCMT 090204E-FF2:T5315	● 0.4	240	0.12	1.0	-	-	-	225	0.12	1.0	-	-	-	-	-	-	-	-
TCMT 090204E-FF2:T7325	● 0.4	165	0.12	1.0	-	-	-	-	-	-	-	-	-	-	-	-	-	-
TCMT 090204E-FF2:T8430	● 0.4	175	0.12	1.0	-	-	-	140	0.12	1.0	-	-	-	-	-	-	-	-
TCMT 090204E-FF2:T9325	● 0.4	215	0.12	1.0	-	-	-	200	0.12	1.0	-	-	-	-	-	-	-	-
TCMT 090204E-FF2:T9415	● 0.4	260	0.12	1.0	-	-	-	245	0.12	1.0	-	-	-	-	-	-	-	-
TCMT 110204E-FF2:T8430	● 0.4	180	0.12	0.8	-	-	-	145	0.12	0.8	-	-	-	-	-	-	-	-
TCMT 110204E-FF2:T9325	● 0.4	220	0.12	0.8	-	-	-	205	0.12	0.8	-	-	-	-	-	-	-	-
TCMT 110204E-FF2:T9335	● 0.4	185	0.12	0.8	-	-	-	-	-	-	-	-	-	-	-	-	-	-
TCMT 110204E-FF2:T9415	● 0.4	265	0.12	0.8	-	-	-	250	0.12	0.8	-	-	-	-	-	-	-	-
TCMT 110208E-FF2:T8430	● 0.8	185	0.17	0.8	-	-	-	150	0.17	0.8	-	-	-	-	-	-	-	-
TCMT 110208E-FF2:T9325	● 0.8	225	0.17	0.8	-	-	-	210	0.17	0.8	-	-	-	-	-	-	-	-
TCMT 110208E-FF2:T9415	● 0.8	280	0.17	0.8	-	-	-	265	0.17	0.8	-	-	-	-	-	-	-	-
TCMT 16T304E-FF2:T8430	● 0.4	180	0.12	0.8	-	-	-	145	0.12	0.8	-	-	-	-	-	-	-	-
TCMT 16T304E-FF2:T9325	● 0.4	220	0.12	0.8	-	-	-	205	0.12	0.8	-	-	-	-	-	-	-	-
TCMT 16T304E-FF2:T9335	● 0.4	185	0.12	0.8	-	-	-	-	-	-	-	-	-	-	-	-	-	-
TCMT 16T304E-FF2:T9415	● 0.4	265	0.12	0.8	-	-	-	250	0.12	0.8	-	-	-	-	-	-	-	-
TCMT 16T304E-FF2:TT010	● 0.4	295	0.06	0.5	-	-	-	-	-	-	-	-	-	-	-	-	-	-

Suitability and starting values for cutting speed (vc), feed (f) and depth of cut (ap). Refer to our Machining Calculator app for further calculations.

Product	RE (mm)	P			M			K			N			S			H		
		vc (m/min)	f (mm/rev)	ap (mm)	vc (m/min)	f (mm/rev)	ap (mm)	vc (m/min)	f (mm/rev)	ap (mm)	vc (m/min)	f (mm/rev)	ap (mm)	vc (m/min)	f (mm/rev)	ap (mm)	vc (m/min)	f (mm/rev)	ap (mm)

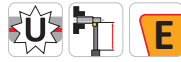
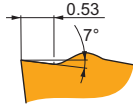

FF2 chip breaker is sharp and the first choice for fine-finishing of Steels. It features slightly positive rake angle without T-land. It's also suitable for Cast irons.

TCMT 16T308E-FF2:T8430	● 0.8	■ 185	0.17	0.8	–	–	–	■ 150	0.17	0.8	–	–	–	–	–	–	–	–
TCMT 16T308E-FF2:T9325	● 0.8	■ 225	0.17	0.8	–	–	–	■ 210	0.17	0.8	–	–	–	–	–	–	–	–
TCMT 16T308E-FF2:T9335	● 0.8	■ 195	0.17	0.8	–	–	–	–	–	–	–	–	–	–	–	–	–	–
TCMT 16T308E-FF2:T9415	● 0.8	■ 280	0.17	0.8	–	–	–	■ 265	0.17	0.8	–	–	–	–	–	–	–	–

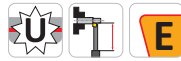
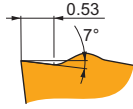

FF2 chip breaker is sharp and the first choice for fine-finishing of Steels. It features slightly positive rake angle without T-land. It's also suitable for Cast irons.

VBMT 160404E-FF2:T7325	● 0.4	■ 145	0.12	0.8	–	–	–	–	–	–	–	–	–	–	–	–	–	–
VBMT 160404E-FF2:T8430	● 0.4	■ 150	0.12	0.8	–	–	–	■ 125	0.12	0.8	–	–	–	–	–	–	–	–
VBMT 160404E-FF2:T9325	● 0.4	■ 190	0.12	0.8	–	–	–	■ 180	0.12	0.8	–	–	–	–	–	–	–	–
VBMT 160404E-FF2:T9335	● 0.4	■ 160	0.12	0.8	–	–	–	–	–	–	–	–	–	–	–	–	–	–
VBMT 160404E-FF2:T9415	● 0.4	■ 230	0.12	0.8	–	–	–	■ 215	0.12	0.8	–	–	–	–	–	–	–	–

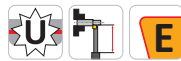
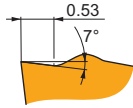

FF2 chip breaker is sharp and the first choice for fine-finishing of Steels. It features slightly positive rake angle without T-land. It's also suitable for Cast irons.

VCGT 070202E-FF2:T8315	● 0.2	■ 150	0.05	0.8	–	–	–	■ 140	0.05	0.8	–	–	–	–	–	–	–	–
VCGT 070202E-FF2:T8415	● 0.2	■ 185	0.05	0.8	–	–	–	■ 165	0.05	0.8	–	–	–	–	–	–	–	–
VCGT 070202E-FF2:T8430	● 0.2	■ 190	0.05	0.8	–	–	–	■ 155	0.05	0.8	–	–	–	–	–	–	–	–
VCGT 070204E-FF2:T8315	● 0.4	■ 125	0.12	0.8	–	–	–	■ 115	0.12	0.8	–	–	–	–	–	–	–	–
VCGT 070204E-FF2:T8415	● 0.4	■ 155	0.12	0.8	–	–	–	■ 140	0.12	0.8	–	–	–	–	–	–	–	–
VCGT 070204E-FF2:T8430	● 0.4	■ 145	0.12	0.8	–	–	–	■ 120	0.12	0.8	–	–	–	–	–	–	–	–
VCGT 130302E-FF2:T5315	● 0.2	■ 250	0.05	1.0	–	–	–	■ 235	0.05	1.0	–	–	–	–	–	–	–	–
VCGT 130302E-FF2:T8430	● 0.2	■ 185	0.05	1.0	–	–	–	■ 150	0.05	1.0	–	–	–	–	–	–	–	–
VCGT 130302E-FF2:T9325	● 0.2	■ 240	0.05	1.0	–	–	–	■ 225	0.05	1.0	–	–	–	–	–	–	–	–
VCGT 130302E-FF2:T9415	● 0.2	■ 270	0.05	1.0	–	–	–	■ 255	0.05	1.0	–	–	–	–	–	–	–	–
VCGT 130302E-FF2:TT010	● 0.2	■ 240	0.05	0.5	–	–	–	–	–	–	–	–	–	–	–	–	–	–
VCGT 130304E-FF2:T5315	● 0.4	■ 195	0.12	1.0	–	–	–	■ 185	0.12	1.0	–	–	–	–	–	–	–	–
VCGT 130304E-FF2:T7325	● 0.4	■ 135	0.12	1.0	–	–	–	–	–	–	–	–	–	–	–	–	–	–
VCGT 130304E-FF2:T8430	● 0.4	■ 140	0.12	1.0	–	–	–	■ 115	0.12	1.0	–	–	–	–	–	–	–	–
VCGT 130304E-FF2:T9325	● 0.4	■ 175	0.12	1.0	–	–	–	■ 165	0.12	1.0	–	–	–	–	–	–	–	–
VCGT 130304E-FF2:T9415	● 0.4	■ 215	0.12	1.0	–	–	–	■ 200	0.12	1.0	–	–	–	–	–	–	–	–
VCGT 130304E-FF2:TT010	● 0.4	■ 245	0.06	0.5	–	–	–	–	–	–	–	–	–	–	–	–	–	–
VCGT 130308E-FF2:T9325	● 0.8	■ 180	0.17	1.0	–	–	–	■ 170	0.17	1.0	–	–	–	–	–	–	–	–
VCGT 130308E-FF2:T9415	● 0.8	■ 225	0.17	1.0	–	–	–	■ 210	0.17	1.0	–	–	–	–	–	–	–	–
VCGT 130308E-FF2:TT010	● 0.8	■ 245	0.10	0.8	–	–	–	–	–	–	–	–	–	–	–	–	–	–

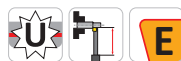
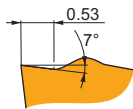

FF2 chip breaker is sharp and the first choice for fine-finishing of Steels. It features slightly positive rake angle without T-land. It's also suitable for Cast irons.

VCGX 130300FR-FF2:T6310	● 0.0	■ 140	0.05	1.0	–	–	–	■ 110	0.05	1.0	–	–	–	–	–	–	–	–
VCGX 130300FR-FF2:T8315	● 0.0	■ 150	0.05	1.0	–	–	–	■ 140	0.05	1.0	–	–	–	–	–	–	–	–
VCGX 130300FR-FF2:T8415	● 0.0	■ 180	0.05	1.0	–	–	–	■ 160	0.05	1.0	–	–	–	–	–	–	–	–
VCGX 130300FR-FF2:TT010	● 0.0	■ 240	0.05	0.5	–	–	–	–	–	–	–	–	–	–	–	–	–	–
VCGX 130301FR-FF2:T6310	● 0.1	■ 140	0.05	1.0	–	–	–	■ 110	0.05	1.0	–	–	–	–	–	–	–	–
VCGX 130301FR-FF2:T8315	● 0.1	■ 150	0.05	1.0	–	–	–	■ 140	0.05	1.0	–	–	–	–	–	–	–	–
VCGX 130301FR-FF2:T8415	● 0.1	■ 180	0.05	1.0	–	–	–	■ 160	0.05	1.0	–	–	–	–	–	–	–	–
VCGX 130301FR-FF2:TT010	● 0.1	■ 240	0.05	0.5	–	–	–	–	–	–	–	–	–	–	–	–	–	–

Suitability and starting values for cutting speed (vc), feed (f) and depth of cut (ap). Refer to our Machining Calculator app for further calculations.

Product	RE (mm)	P			M			K			N			S			H		
		vc (m/min)	f (mm/rev)	ap (mm)	vc (m/min)	f (mm/rev)	ap (mm)	vc (m/min)	f (mm/rev)	ap (mm)	vc (m/min)	f (mm/rev)	ap (mm)	vc (m/min)	f (mm/rev)	ap (mm)	vc (m/min)	f (mm/rev)	ap (mm)

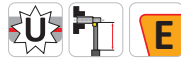
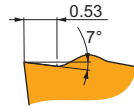

FF2 chip breaker is sharp and the first choice for fine-finishing of Steels. It features slightly positive rake angle without T-land. It's also suitable for Cast irons.

VCGX 130300FL-FF2:T8315	● 0.0	150	0.05	1.0	–	–	–	140	0.05	1.0	–	–	–	–	–	–	–	–
VCGX 130300FL-FF2:T8415	● 0.0	180	0.05	1.0	–	–	–	160	0.05	1.0	–	–	–	–	–	–	–	–
VCGX 130300FL-FF2:TT010	● 0.0	240	0.05	0.5	–	–	–	–	–	–	–	–	–	–	–	–	–	–
VCGX 130301FL-FF2:T8315	● 0.1	150	0.05	1.0	–	–	–	140	0.05	1.0	–	–	–	–	–	–	–	–
VCGX 130301FL-FF2:T8415	● 0.1	180	0.05	1.0	–	–	–	160	0.05	1.0	–	–	–	–	–	–	–	–

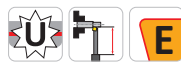
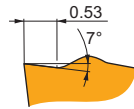

FF2 chip breaker is sharp and the first choice for fine-finishing of Steels. It features slightly positive rake angle without T-land. It's also suitable for Cast irons.

WCGT 020102E-FF2:HF7	● 0.2	–	–	–	–	–	–	210	0.05	0.8	–	–	–	–	–	–	–	–
WCGT 020102E-FF2:T8430	● 0.2	280	0.05	0.8	–	–	–	230	0.05	0.8	–	–	–	–	–	–	–	–
WCGT 020102E-FF2:TT010	● 0.2	345	0.05	0.5	–	–	–	–	–	–	–	–	–	–	–	–	–	–
WCGT 020104E-FF2:HF7	● 0.4	–	–	–	–	–	–	155	0.12	0.8	–	–	–	–	–	–	–	–
WCGT 020104E-FF2:T8430	● 0.4	205	0.12	0.8	–	–	–	170	0.12	0.8	–	–	–	–	–	–	–	–
WCGT 020104E-FF2:TT010	● 0.4	350	0.06	0.5	–	–	–	–	–	–	–	–	–	–	–	–	–	–

SF3

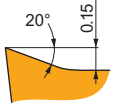

SF3 chip breaker is sharp and the first choice for fine-finishing of Stainless steels and Super-alloys. It features highly positive rake angle without T-land. It's also suitable for Non-ferrous alloys, and conditionally for Steels, Cast irons and Hard materials.



CCGT

	IC (mm)	D1 (mm)	L (mm)	S (mm)
0602-SF3	6.350	2.80	6.40	2.58
0803-SF3	7.940	3.40	8.10	3.43
09T3-SF3	9.525	4.40	9.70	4.22
1204-SF3	12.700	5.50	12.90	5.01

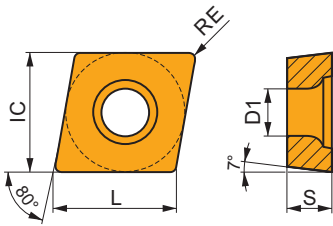

DCGT

	IC (mm)	D1 (mm)	L (mm)	S (mm)
0702-SF3	6.350	2.80	7.80	2.58
11T3-SF3	9.525	4.40	11.60	4.22

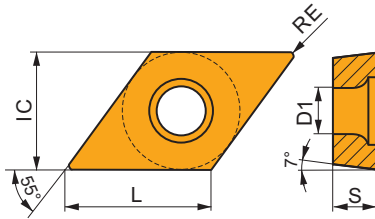

ECGT

	IC (mm)	D1 (mm)	L (mm)	S (mm)
0602-SF3	6.350	2.80	6.50	2.58
0803-SF3	7.940	3.40	8.20	3.43

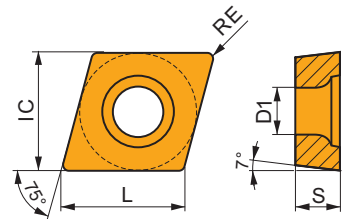

SCGT

	IC (mm)	D1 (mm)	L (mm)	S (mm)
09T3-SF3	9.525	4.40	9.53	4.22

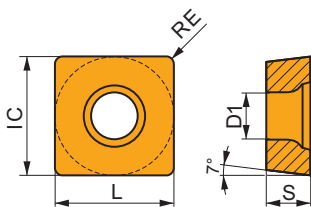

TCGT

	IC (mm)	D1 (mm)	L (mm)	S (mm)
1102-SF3	6.350	2.80	11.00	2.58
16T3-SF3	9.525	4.40	16.50	4.22

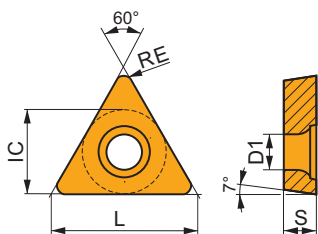

VCGT

	IC (mm)	D1 (mm)	L (mm)	S (mm)
0702	3.970	2.20	6.90	2.38
1102-SF3	6.350	2.80	11.10	2.58
1103-SF3	6.350	2.80	11.10	3.43
1303-SF3	7.940	3.40	13.80	3.43
1604-SF3	9.525	4.40	16.60	5.01

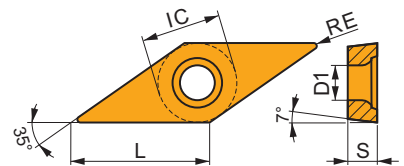

Suitability and starting values for cutting speed (vc), feed (f) and depth of cut (ap). Refer to our Machining Calculator app for further calculations.

Product	RE (mm)	P			M			K			N			S			H		
		vc (m/min)	f (mm/rev)	ap (mm)	vc (m/min)	f (mm/rev)	ap (mm)	vc (m/min)	f (mm/rev)	ap (mm)	vc (m/min)	f (mm/rev)	ap (mm)	vc (m/min)	f (mm/rev)	ap (mm)	vc (m/min)	f (mm/rev)	ap (mm)

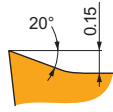

SF3 chip breaker is sharp and the first choice for fine-finishing of Stainless steels and Super-alloys. It features highly positive rake angle without T-land. It's also suitable for Non-ferrous alloys, and conditionally for Steels, Cast irons and Hard materials.

CCGT 060201E-SF3:T6310	●	0.1	200	0.05	0.5	140	0.05	0.5	160	0.05	0.5	600	0.06	0.5	60	0.04	0.4	40	0.05	0.1
CCGT 060202E-SF3:T6310	●	0.2	205	0.05	0.8	145	0.05	0.8	165	0.05	0.8	615	0.06	0.8	60	0.04	0.6	40	0.05	0.2
CCGT 060202E-SF3:T8315	●	0.2	215	0.05	0.8	125	0.05	0.8	200	0.05	0.8	645	0.06	0.8	50	0.04	0.6	40	0.05	0.2
CCGT 060202E-SF3:T8415	●	0.2	270	0.05	0.8	140	0.04	0.8	245	0.05	0.8	675	0.06	0.8	60	0.04	0.6	45	0.05	0.2
CCGT 060204E-SF3:H07	●	0.4	-	-	-	95	0.09	0.8	150	0.10	0.8	485	0.12	0.8	45	0.07	0.6	-	-	-
CCGT 060204E-SF3:T6310	●	0.4	180	0.10	0.8	125	0.09	0.8	145	0.10	0.8	540	0.12	0.8	50	0.07	0.6	35	0.07	0.3
CCGT 060204E-SF3:T8315	●	0.4	190	0.10	0.8	110	0.09	0.8	180	0.10	0.8	570	0.12	0.8	45	0.07	0.6	35	0.07	0.3
CCGT 060204E-SF3:T8415	●	0.4	230	0.10	0.8	120	0.09	0.8	210	0.10	0.8	585	0.12	0.8	50	0.07	0.6	40	0.07	0.3
CCGT 080302E-SF3:T6310	●	0.2	205	0.05	0.8	145	0.05	0.8	165	0.05	0.8	615	0.06	0.8	60	0.04	0.6	40	0.05	0.2
CCGT 080302E-SF3:T8315	●	0.2	215	0.05	0.8	125	0.05	0.8	200	0.05	0.8	645	0.06	0.8	50	0.04	0.6	40	0.05	0.2
CCGT 080302E-SF3:T8415	●	0.2	270	0.05	0.8	140	0.04	0.8	245	0.05	0.8	675	0.06	0.8	60	0.04	0.6	45	0.05	0.2
CCGT 080304E-SF3:T6310	●	0.4	180	0.10	1.0	125	0.09	1.0	145	0.10	1.0	540	0.12	1.0	50	0.07	0.8	35	0.10	0.3
CCGT 080304E-SF3:T8315	●	0.4	190	0.10	1.0	110	0.09	1.0	180	0.10	1.0	570	0.12	1.0	45	0.07	0.8	35	0.10	0.3
CCGT 080304E-SF3:T8415	●	0.4	225	0.10	1.0	115	0.09	1.0	205	0.10	1.0	570	0.12	1.0	50	0.07	0.8	35	0.10	0.3
CCGT 09T301E-SF3:T6310	●	0.1	200	0.05	0.5	140	0.05	0.5	160	0.05	0.5	600	0.06	0.5	60	0.04	0.4	40	0.05	0.1
CCGT 09T302E-SF3:T6310	●	0.2	205	0.05	0.8	145	0.05	0.8	165	0.05	0.8	615	0.06	0.8	60	0.04	0.6	40	0.05	0.2
CCGT 09T302E-SF3:T8315	●	0.2	215	0.05	0.8	125	0.05	0.8	200	0.05	0.8	645	0.06	0.8	50	0.04	0.6	40	0.05	0.2
CCGT 09T302E-SF3:T8415	●	0.2	270	0.05	0.8	140	0.04	0.8	245	0.05	0.8	675	0.06	0.8	60	0.04	0.6	45	0.05	0.2
CCGT 09T304E-SF3:H07	●	0.4	-	-	-	95	0.09	1.0	150	0.10	1.0	485	0.12	1.0	45	0.07	0.8	-	-	-
CCGT 09T304E-SF3:T6310	●	0.4	180	0.10	1.0	125	0.09	1.0	145	0.10	1.0	540	0.12	1.0	50	0.07	0.8	35	0.05	0.3
CCGT 09T304E-SF3:T8315	●	0.4	190	0.10	1.0	110	0.09	1.0	180	0.10	1.0	570	0.12	1.0	45	0.07	0.8	35	0.05	0.3
CCGT 09T304E-SF3:T8415	●	0.4	225	0.10	1.0	115	0.09	1.0	205	0.10	1.0	570	0.12	1.0	50	0.07	0.8	35	0.05	0.3
CCGT 09T308E-SF3:H07	●	0.8	-	-	-	110	0.09	1.0	175	0.10	1.0	565	0.12	1.0	55	0.08	0.8	-	-	-
CCGT 09T308E-SF3:T6310	●	0.8	210	0.10	1.0	150	0.09	1.0	165	0.10	1.0	630	0.12	1.0	60	0.08	0.8	40	0.08	0.7
CCGT 09T308E-SF3:T8315	●	0.8	225	0.10	1.0	135	0.09	1.0	210	0.10	1.0	675	0.12	1.0	55	0.08	0.8	45	0.08	0.7
CCGT 09T308E-SF3:T8415	●	0.8	275	0.10	1.0	140	0.09	1.0	250	0.10	1.0	690	0.12	1.0	60	0.08	0.8	45	0.08	0.7
CCGT 120404E-SF3:T6310	●	0.4	180	0.10	1.0	125	0.09	1.0	145	0.10	1.0	540	0.12	1.0	50	0.07	0.8	35	0.07	0.3
CCGT 120404E-SF3:T8415	●	0.4	225	0.10	1.0	115	0.09	1.0	205	0.10	1.0	570	0.12	1.0	50	0.07	0.8	35	0.07	0.3
CCGT 120408E-SF3:H07	●	0.8	-	-	-	105	0.12	1.0	165	0.12	1.0	525	0.14	1.0	50	0.11	0.8	-	-	-
CCGT 120408E-SF3:T6310	●	0.8	200	0.12	1.0	140	0.12	1.0	160	0.12	1.0	600	0.14	1.0	60	0.11	0.8	40	0.10	0.7
CCGT 120408E-SF3:T8315	●	0.8	210	0.12	1.0	125	0.12	1.0	195	0.12	1.0	630	0.14	1.0	50	0.11	0.8	40	0.10	0.7
CCGT 120408E-SF3:T8415	●	0.8	255	0.12	1.0	135	0.12	1.0	230	0.12	1.0	645	0.14	1.0	55	0.11	0.8	45	0.10	0.7

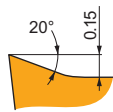

SF3 chip breaker is sharp and the first choice for fine-finishing of Stainless steels and Super-alloys. It features highly positive rake angle without T-land. It's also suitable for Non-ferrous alloys, and conditionally for Steels, Cast irons and Hard materials.

DCGT 070201E-SF3:T6310	●	0.1	160	0.05	0.5	115	0.05	0.5	125	0.05	0.5	480	0.06	0.5	45	0.04	0.4	30	0.05	0.1
DCGT 070202E-SF3:T6310	●	0.2	165	0.05	0.8	115	0.05	0.8	130	0.05	0.8	495	0.06	0.8	45	0.04	0.6	30	0.05	0.2
DCGT 070202E-SF3:T8315	●	0.2	175	0.05	0.8	105	0.05	0.8	165	0.05	0.8	525	0.06	0.8	40	0.04	0.6	35	0.05	0.2
DCGT 070202E-SF3:T8415	●	0.2	215	0.05	0.8	110	0.04	0.8	195	0.05	0.8	540	0.06	0.8	45	0.04	0.6	35	0.05	0.2
DCGT 070204E-SF3:H07	●	0.4	-	-	-	75	0.09	0.8	120	0.10	0.8	390	0.12	0.8	35	0.07	0.6	-	-	-
DCGT 070204E-SF3:T6310	●	0.4	145	0.10	0.8	100	0.09	0.8	115	0.10	0.8	435	0.12	0.8	40	0.07	0.6	25	0.07	0.3
DCGT 070204E-SF3:T8315	●	0.4	155	0.10	0.8	90	0.09	0.8	145	0.10	0.8	465	0.12	0.8	35	0.07	0.6	30	0.07	0.3
DCGT 070204E-SF3:T8415	●	0.4	185	0.10	0.8	95	0.09	0.8	165	0.10	0.8	465	0.12	0.8	40	0.07	0.6	30	0.07	0.3
DCGT 11T301E-SF3:T6310	●	0.1	160	0.05	0.5	115	0.05	0.5	125	0.05	0.5	480	0.06	0.5	45	0.04	0.4	30	0.05	0.1
DCGT 11T302E-SF3:H07	●	0.2	-	-	-	95	0.05	0.8	150	0.05	0.8	485	0.06	0.8	45	0.04	0.6	-	-	-
DCGT 11T302E-SF3:T6310	●	0.2	165	0.05	0.8	115	0.05	0.8	130	0.05	0.8	495	0.06	0.8	45	0.04	0.6	30	0.05	0.2
DCGT 11T302E-SF3:T8415	●	0.2	215	0.05	0.8	110	0.04	0.8	195	0.05	0.8	540	0.06	0.8	45	0.04	0.6	35	0.05	0.2
DCGT 11T304E-SF3:H07	●	0.4	-	-	-	75	0.09	0.8	120	0.10	0.8	390	0.12	0.8	35	0.07	0.6	-	-	-
DCGT 11T304E-SF3:T6310	●	0.4	145	0.10	0.8	100	0.09	0.8	115	0.10	0.8	435	0.12	0.8	40	0.07	0.6	25	0.07	0.3
DCGT 11T304E-SF3:T8315	●	0.4	155	0.10	0.8	90	0.09	0.8	145	0.10	0.8	465	0.12	0.8	35	0.07	0.6	30	0.07	0.3
DCGT 11T304E-SF3:T8415	●	0.4	185	0.10	0.8	95	0.09	0.8	165	0.10	0.8	465	0.12	0.8	40	0.07	0.6	30	0.07	0.3
DCGT 11T308E-SF3:H07	●	0.8	-	-	-	90	0.09	0.8	145	0.10	0.8	455	0.12	0.8	45	0.08	0.6	-	-	-
DCGT 11T308E-SF3:T6310	●	0.8	170	0.10	0.8	120	0.09	0.8	135	0.10	0.8	510	0.12	0.8	50	0.08	0.6	30	0.08	0.7
DCGT 11T308E-SF3:T8315	●	0.8	180	0.10	0.8	105	0.09	0.8	170	0.10	0.8	540	0.12	0.8	45	0.08	0.6	35	0.08	0.7
DCGT 11T308E-SF3:T8415	●	0.8	220	0.10	0.8	115	0.09	0.8	200	0.10	0.8	555	0.12	0.8	50	0.08	0.6	35	0.08	0.7

Suitability and starting values for cutting speed (vc), feed (f) and depth of cut (ap). Refer to our Machining Calculator app for further calculations.

Product	RE (mm)	P			M			K			N			S			H		
		vc (m/min)	f (mm/rev)	ap (mm)	vc (m/min)	f (mm/rev)	ap (mm)	vc (m/min)	f (mm/rev)	ap (mm)	vc (m/min)	f (mm/rev)	ap (mm)	vc (m/min)	f (mm/rev)	ap (mm)	vc (m/min)	f (mm/rev)	ap (mm)

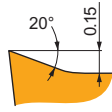
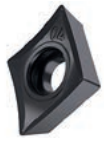

SF3 chip breaker is sharp and the first choice for fine-finishing of Stainless steels and Super-alloys. It features highly positive rake angle without T-land. It's also suitable for Non-ferrous alloys, and conditionally for Steels, Cast irons and Hard materials.

ECGT 060202E-SF3:H07	● 0.2	–	–	–	█ 105	0.05	0.8	█ 170	0.05	0.8	█ 540	0.06	0.8	█ 55	0.04	0.6	–	–	–
ECGT 060202E-SF3:T6310	● 0.2	█ 185	0.05	0.8	█ 130	0.05	0.8	█ 145	0.05	0.8	█ 555	0.06	0.8	█ 55	0.04	0.6	█ 35	0.05	0.2
ECGT 060202E-SF3:T8415	● 0.2	█ 240	0.05	0.8	█ 125	0.04	0.8	█ 215	0.05	0.8	█ 600	0.06	0.8	█ 55	0.04	0.6	█ 40	0.05	0.2
ECGT 080304E-SF3:H07	● 0.4	–	–	–	█ 85	0.09	1.0	█ 135	0.10	1.0	█ 430	0.12	1.0	█ 40	0.07	0.8	–	–	–
ECGT 080304E-SF3:T6310	● 0.4	█ 160	0.10	1.0	█ 115	0.09	1.0	█ 125	0.10	1.0	█ 480	0.12	1.0	█ 45	0.07	0.8	█ 30	0.05	0.3
ECGT 080304E-SF3:T8415	● 0.4	█ 200	0.10	1.0	█ 105	0.09	1.0	█ 185	0.10	1.0	█ 510	0.12	1.0	█ 45	0.07	0.8	█ 35	0.05	0.3

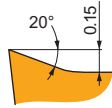
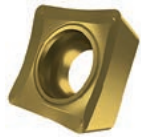

SF3 chip breaker is sharp and the first choice for fine-finishing of Stainless steels and Super-alloys. It features highly positive rake angle without T-land. It's also suitable for Non-ferrous alloys, and conditionally for Steels, Cast irons and Hard materials.

SCGT 09T304E-SF3:H07	● 0.4	–	–	–	█ 95	0.09	1.0	█ 155	0.10	1.0	█ 495	0.12	1.0	█ 50	0.07	0.8	–	–	–
SCGT 09T304E-SF3:T6310	● 0.4	█ 185	0.10	1.0	█ 130	0.09	1.0	█ 145	0.10	1.0	█ 555	0.12	1.0	█ 55	0.07	0.8	█ 35	0.05	0.3
SCGT 09T304E-SF3:T8315	● 0.4	█ 200	0.10	1.0	█ 120	0.09	1.0	█ 190	0.10	1.0	█ 600	0.12	1.0	█ 50	0.07	0.8	█ 40	0.05	0.3
SCGT 09T304E-SF3:T8415	● 0.4	█ 240	0.10	1.0	█ 125	0.09	1.0	█ 215	0.10	1.0	█ 600	0.12	1.0	█ 55	0.07	0.8	█ 40	0.05	0.3
SCGT 09T308E-SF3:T6310	● 0.8	█ 210	0.12	1.0	█ 150	0.12	1.0	█ 165	0.12	1.0	█ 630	0.14	1.0	█ 60	0.11	0.8	█ 40	0.10	0.7
SCGT 09T308E-SF3:T8315	● 0.8	█ 220	0.12	1.0	█ 130	0.12	1.0	█ 205	0.12	1.0	█ 660	0.14	1.0	█ 55	0.11	0.8	█ 40	0.10	0.7
SCGT 09T308E-SF3:T8415	● 0.8	█ 270	0.12	1.0	█ 140	0.12	1.0	█ 245	0.12	1.0	█ 675	0.14	1.0	█ 60	0.11	0.8	█ 45	0.10	0.7

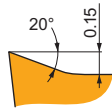

SF3 chip breaker is sharp and the first choice for fine-finishing of Stainless steels and Super-alloys. It features highly positive rake angle without T-land. It's also suitable for Non-ferrous alloys, and conditionally for Steels, Cast irons and Hard materials.

TCGT 110202E-SF3:T6310	● 0.2	█ 175	0.05	0.8	█ 125	0.05	0.8	█ 140	0.05	0.8	█ 525	0.06	0.8	█ 50	0.04	0.6	█ 35	0.05	0.2
TCGT 110202E-SF3:T8315	● 0.2	█ 185	0.05	0.8	█ 110	0.05	0.8	█ 175	0.05	0.8	█ 555	0.06	0.8	█ 45	0.04	0.6	█ 35	0.05	0.2
TCGT 110202E-SF3:T8415	● 0.2	█ 225	0.05	0.8	█ 115	0.04	0.8	█ 205	0.05	0.8	█ 570	0.06	0.8	█ 50	0.04	0.6	█ 35	0.05	0.2
TCGT 110204E-SF3:H07	● 0.4	–	–	–	█ 80	0.09	0.8	█ 130	0.10	0.8	█ 415	0.12	0.8	█ 40	0.07	0.6	–	–	–
TCGT 110204E-SF3:T6310	● 0.4	█ 155	0.10	0.8	█ 110	0.09	0.8	█ 125	0.10	0.8	█ 465	0.12	0.8	█ 45	0.07	0.6	█ 30	0.07	0.3
TCGT 110204E-SF3:T8315	● 0.4	█ 165	0.10	0.8	█ 95	0.09	0.8	█ 155	0.10	0.8	█ 495	0.12	0.8	█ 40	0.07	0.6	█ 30	0.07	0.3
TCGT 110204E-SF3:T8415	● 0.4	█ 195	0.10	0.8	█ 100	0.09	0.8	█ 180	0.10	0.8	█ 495	0.12	0.8	█ 45	0.07	0.6	█ 30	0.07	0.3
TCGT 16T304E-SF3:H07	● 0.4	–	–	–	█ 80	0.09	1.0	█ 125	0.10	1.0	█ 405	0.12	1.0	█ 40	0.07	0.8	–	–	–
TCGT 16T304E-SF3:T6310	● 0.4	█ 150	0.10	1.0	█ 105	0.09	1.0	█ 120	0.10	1.0	█ 450	0.12	1.0	█ 45	0.07	0.8	█ 30	0.07	0.3
TCGT 16T304E-SF3:T8315	● 0.4	█ 160	0.10	1.0	█ 95	0.09	1.0	█ 150	0.10	1.0	█ 480	0.12	1.0	█ 40	0.07	0.8	█ 30	0.07	0.3
TCGT 16T304E-SF3:T8415	● 0.4	█ 195	0.10	1.0	█ 100	0.09	1.0	█ 180	0.10	1.0	█ 495	0.12	1.0	█ 45	0.07	0.8	█ 30	0.07	0.3
TCGT 16T308E-SF3:H07	● 0.8	–	–	–	█ 90	0.09	1.2	█ 145	0.10	1.2	█ 470	0.12	1.2	█ 45	0.08	1.0	–	–	–
TCGT 16T308E-SF3:T6310	● 0.8	█ 175	0.10	1.2	█ 125	0.09	1.2	█ 140	0.10	1.2	█ 525	0.12	1.2	█ 50	0.08	1.0	█ 35	0.08	0.7
TCGT 16T308E-SF3:T8315	● 0.8	█ 185	0.10	1.2	█ 110	0.09	1.2	█ 175	0.10	1.2	█ 555	0.12	1.2	█ 45	0.08	1.0	█ 35	0.08	0.7
TCGT 16T308E-SF3:T8415	● 0.8	█ 225	0.10	1.2	█ 115	0.09	1.2	█ 205	0.10	1.2	█ 570	0.12	1.2	█ 50	0.08	1.0	█ 35	0.08	0.7
TCGT 16T312E-SF3:T6310	● 1.2	█ 150	0.20	1.2	█ 105	0.18	1.2	█ 120	0.20	1.2	█ 450	0.24	1.2	█ 45	0.14	1.0	█ 30	0.10	0.9
TCGT 16T312E-SF3:T8415	● 1.2	█ 190	0.20	1.2	█ 100	0.18	1.2	█ 170	0.20	1.2	█ 480	0.24	1.2	█ 40	0.14	1.0	█ 30	0.10	0.9

Suitability and starting values for cutting speed (vc), feed (f) and depth of cut (ap). Refer to our Machining Calculator app for further calculations.

Product	RE (mm)	P			M			K			N			S			H		
		vc (m/min)	f (mm/rev)	ap (mm)	vc (m/min)	f (mm/rev)	ap (mm)	vc (m/min)	f (mm/rev)	ap (mm)	vc (m/min)	f (mm/rev)	ap (mm)	vc (m/min)	f (mm/rev)	ap (mm)	vc (m/min)	f (mm/rev)	ap (mm)

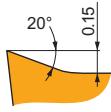

SF3 chip breaker is sharp and the first choice for fine-finishing of Stainless steels and Super-alloys. It features highly positive rake angle without T-land. It's also suitable for Non-ferrous alloys, and conditionally for Steels, Cast irons and Hard materials.

VCGT 070202E-SF3:H07	●	0.2	–	–	–	■	80	0.05	0.8	■	130	0.05	0.8	■	415	0.06	0.8	■	40	0.04	0.6	–	–	–		
VCGT 070202E-SF3:T6310	●	0.2	■	145	0.05	0.8	■	100	0.05	0.8	■	115	0.05	0.8	■	435	0.06	0.8	■	40	0.04	0.6	■	25	0.05	0.2
VCGT 070202E-SF3:T8415	●	0.2	■	185	0.05	0.8	■	95	0.04	0.8	■	165	0.05	0.8	■	465	0.06	0.8	■	40	0.04	0.6	■	30	0.05	0.2
VCGT 070204E-SF3:T6310	●	0.4	■	125	0.10	0.8	■	90	0.09	0.8	■	100	0.10	0.8	■	375	0.12	0.8	■	35	0.07	0.6	■	25	0.07	0.3
VCGT 070204E-SF3:T8415	●	0.4	■	160	0.10	0.8	■	85	0.09	0.8	■	145	0.10	0.8	■	405	0.12	0.8	■	35	0.07	0.6	■	25	0.07	0.3
VCGT 110202E-SF3:T6310	●	0.2	■	145	0.05	0.8	■	100	0.05	0.8	■	115	0.05	0.8	■	435	0.06	0.8	■	40	0.04	0.6	■	25	0.05	0.2
VCGT 110202E-SF3:T8315	●	0.2	■	150	0.05	0.8	■	90	0.05	0.8	■	140	0.05	0.8	■	450	0.06	0.8	■	35	0.04	0.6	■	30	0.05	0.2
VCGT 110202E-SF3:T8415	●	0.2	■	185	0.05	0.8	■	95	0.04	0.8	■	165	0.05	0.8	■	465	0.06	0.8	■	40	0.04	0.6	■	30	0.05	0.2
VCGT 110204E-SF3:H07	●	0.4	–	–	–	■	65	0.09	0.8	■	105	0.10	0.8	■	335	0.12	0.8	■	30	0.07	0.6	–	–	–		
VCGT 110204E-SF3:T6310	●	0.4	■	125	0.10	0.8	■	90	0.09	0.8	■	100	0.10	0.8	■	375	0.12	0.8	■	35	0.07	0.6	■	25	0.07	0.3
VCGT 110204E-SF3:T8315	●	0.4	■	135	0.10	0.8	■	80	0.09	0.8	■	125	0.10	0.8	■	405	0.12	0.8	■	30	0.07	0.6	■	25	0.07	0.3
VCGT 110204E-SF3:T8415	●	0.4	■	160	0.10	0.8	■	85	0.09	0.8	■	145	0.10	0.8	■	405	0.12	0.8	■	35	0.07	0.6	■	25	0.07	0.3
VCGT 110301E-SF3:T6310	●	0.1	■	140	0.05	0.5	■	100	0.05	0.5	■	110	0.05	0.5	■	420	0.06	0.5	■	40	0.04	0.4	■	25	0.05	0.1
VCGT 110302E-SF3:T6310	●	0.2	■	145	0.05	0.8	■	100	0.05	0.8	■	115	0.05	0.8	■	435	0.06	0.8	■	40	0.04	0.6	■	25	0.05	0.2
VCGT 110304E-SF3:T6310	●	0.4	■	125	0.10	0.8	■	90	0.09	0.8	■	100	0.10	0.8	■	375	0.12	0.8	■	35	0.07	0.6	■	25	0.07	0.3
VCGT 110304E-SF3:T8415	●	0.4	■	160	0.10	0.8	■	85	0.09	0.8	■	145	0.10	0.8	■	405	0.12	0.8	■	35	0.07	0.6	■	25	0.07	0.3
VCGT 130302E-SF3:H07	●	0.2	–	–	–	■	80	0.05	0.8	■	130	0.05	0.8	■	415	0.06	0.8	■	40	0.04	0.6	–	–	–		
VCGT 130302E-SF3:T6310	●	0.2	■	145	0.05	0.8	■	100	0.05	0.8	■	115	0.05	0.8	■	435	0.06	0.8	■	40	0.04	0.6	■	25	0.05	0.2
VCGT 130302E-SF3:T8315	●	0.2	■	150	0.05	0.8	■	90	0.05	0.8	■	140	0.05	0.8	■	450	0.06	0.8	■	35	0.04	0.6	■	30	0.05	0.2
VCGT 130302E-SF3:T8415	●	0.2	■	185	0.05	0.8	■	95	0.04	0.8	■	165	0.05	0.8	■	465	0.06	0.8	■	40	0.04	0.6	■	30	0.05	0.2
VCGT 130304E-SF3:H07	●	0.4	–	–	–	■	65	0.09	1.0	■	105	0.10	1.0	■	335	0.12	1.0	■	30	0.07	0.8	–	–	–		
VCGT 130304E-SF3:T6310	●	0.4	■	125	0.10	1.0	■	90	0.09	1.0	■	100	0.10	1.0	■	375	0.12	1.0	■	35	0.07	0.8	■	25	0.07	0.3
VCGT 130304E-SF3:T8315	●	0.4	■	130	0.10	1.0	■	75	0.09	1.0	■	120	0.10	1.0	■	390	0.12	1.0	■	30	0.07	0.8	■	25	0.07	0.3
VCGT 130304E-SF3:T8415	●	0.4	■	160	0.10	1.0	■	85	0.09	1.0	■	145	0.10	1.0	■	405	0.12	1.0	■	35	0.07	0.8	■	25	0.07	0.3
VCGT 130308E-SF3:H07	●	0.8	–	–	–	■	75	0.09	1.0	■	120	0.10	1.0	■	390	0.12	1.0	■	35	0.08	0.8	–	–	–		
VCGT 130308E-SF3:T6310	●	0.8	■	145	0.10	1.0	■	100	0.09	1.0	■	115	0.10	1.0	■	435	0.12	1.0	■	40	0.08	0.8	■	25	0.08	0.7
VCGT 130308E-SF3:T8315	●	0.8	■	155	0.10	1.0	■	90	0.09	1.0	■	145	0.10	1.0	■	465	0.12	1.0	■	35	0.08	0.8	■	30	0.08	0.7
VCGT 130308E-SF3:T8415	●	0.8	■	190	0.10	1.0	■	100	0.09	1.0	■	170	0.10	1.0	■	480	0.12	1.0	■	40	0.08	0.8	■	30	0.08	0.7
VCGT 160402E-SF3:T6310	●	0.2	■	145	0.05	0.8	■	100	0.05	0.8	■	115	0.05	0.8	■	435	0.06	0.8	■	40	0.04	0.6	■	25	0.05	0.2
VCGT 160402E-SF3:T8415	●	0.2	■	185	0.05	0.8	■	95	0.04	0.8	■	165	0.05	0.8	■	465	0.06	0.8	■	40	0.04	0.6	■	30	0.05	0.2
VCGT 160404E-SF3:H07	●	0.4	–	–	–	■	65	0.09	1.0	■	105	0.10	1.0	■	335	0.12	1.0	■	30	0.07	0.8	–	–	–		
VCGT 160404E-SF3:T6310	●	0.4	■	125	0.10	1.0	■	90	0.09	1.0	■	100	0.10	1.0	■	375	0.12	1.0	■	35	0.07	0.8	■	25	0.07	0.3
VCGT 160404E-SF3:T8315	●	0.4	■	130	0.10	1.0	■	75	0.09	1.0	■	120	0.10	1.0	■	390	0.12	1.0	■	30	0.07	0.8	■	25	0.07	0.3
VCGT 160404E-SF3:T8415	●	0.4	■	160	0.10	1.0	■	85	0.09	1.0	■	145	0.10	1.0	■	405	0.12	1.0	■	35	0.07	0.8	■	25	0.07	0.3
VCGT 160408E-SF3:H07	●	0.8	–	–	–	■	75	0.09	1.2	■	120	0.10	1.2	■	390	0.12	1.2	■	35	0.08	1.0	–	–	–		
VCGT 160408E-SF3:T6310	●	0.8	■	145	0.10	1.2	■	100	0.09	1.2	■	115	0.10	1.2	■	435	0.12	1.2	■	40	0.08	1.0	■	25	0.08	0.7
VCGT 160408E-SF3:T8315	●	0.8	■	155	0.10	1.2	■	90	0.09	1.2	■	145	0.10	1.2	■	465	0.12	1.2	■	35	0.08	1.0	■	30	0.08	0.7
VCGT 160408E-SF3:T8415	●	0.8	■	185	0.10	1.2	■	95	0.09	1.2	■	165	0.10	1.2	■	465	0.12	1.2	■	40	0.08	1.0	■	30	0.08	0.7
VCGT 160412E-SF3:H07	●	1.2	–	–	–	■	60	0.18	1.2	■	95	0.20	1.2	■	310	0.24	1.2	■	30	0.14	1.0	–	–	–		
VCGT 160412E-SF3:T6310	●	1.2	■	125	0.20	1.2	■	90	0.18	1.2	■	100	0.20	1.2	■	375	0.24	1.2	■	35	0.14	1.0	■	25	0.10	0.9
VCGT 160412E-SF3:T8415	●	1.2	■	160	0.20	1.2	■	85	0.18	1.2	■	145	0.20	1.2	■	405	0.24	1.2	■	35	0.14	1.0	■	25	0.10	0.9

NF1

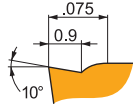

NF1 chip breaker is sharp and designed for fine-finishing of Steels, Stainless steels and Super-alloys. It features positive rake angle without T-land. It's also conditionally suitable for Non-ferrous alloys and Hard materials.



CCGT

	IC (mm)	D1 (mm)	L (mm)	S (mm)
0602	6.350	2.80	6.40	2.38
09T3	9.525	4.40	9.70	3.97

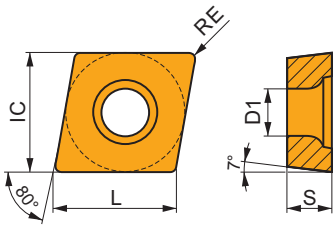

DCGT

	IC (mm)	D1 (mm)	L (mm)	S (mm)
11T3	9.525	4.40	11.60	3.97

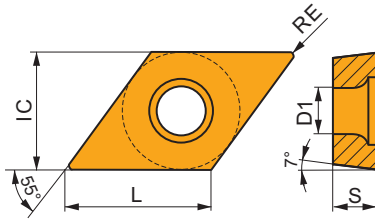

SCGT

	IC (mm)	D1 (mm)	L (mm)	S (mm)
09T3	9.525	4.40	9.53	3.97
1204	12.700	5.50	12.70	4.76

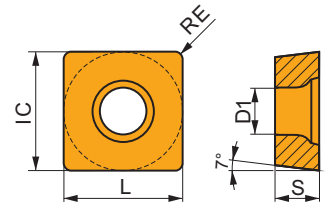

TCGT

	IC (mm)	D1 (mm)	L (mm)	S (mm)
1102	6.350	2.80	11.00	2.38

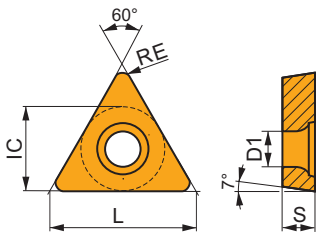

Suitability and starting values for cutting speed (vc), feed (f) and depth of cut (ap). Refer to our Machining Calculator app for further calculations.

Product	RE (mm)	P			M			K			N			S			H		
		vc (m/min)	f (mm/rev)	ap (mm)	vc (m/min)	f (mm/rev)	ap (mm)	vc (m/min)	f (mm/rev)	ap (mm)	vc (m/min)	f (mm/rev)	ap (mm)	vc (m/min)	f (mm/rev)	ap (mm)	vc (m/min)	f (mm/rev)	ap (mm)

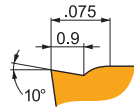

NF1 chip breaker is sharp and designed for fine-finishing of Steels, Stainless steels and Super-alloys. It features positive rake angle without T-land. It's also conditionally suitable for Non-ferrous alloys and Hard materials.

CCGT 060204E-NF1:T6310	● 0.4	180	0.10	0.8	125	0.09	0.8	-	-	-	540	0.12	0.8	50	0.07	0.6	35	0.08	0.3
CCGT 060204E-NF1:T7325	● 0.4	210	0.10	0.8	160	0.09	0.8	-	-	-	-	-	-	65	0.07	0.6	-	-	-
CCGT 060208E-NF1:T6310	● 0.8	205	0.12	0.8	145	0.11	0.8	-	-	-	615	0.14	0.8	60	0.11	0.6	40	0.09	0.7
CCGT 09T304E-NF1:T6310	● 0.4	175	0.10	1.2	125	0.09	1.2	-	-	-	525	0.12	1.2	50	0.07	1.0	35	0.08	0.3
CCGT 09T304E-NF1:T7325	● 0.4	200	0.10	1.2	155	0.09	1.2	-	-	-	-	-	-	65	0.07	1.0	-	-	-
CCGT 09T308E-NF1:T6310	● 0.8	190	0.14	1.2	135	0.13	1.2	-	-	-	570	0.17	1.2	55	0.13	1.0	35	0.11	0.7
CCGT 09T308E-NF1:T7325	● 0.8	215	0.14	1.2	165	0.13	1.2	-	-	-	-	-	-	65	0.13	1.0	-	-	-

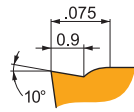

NF1 chip breaker is sharp and designed for fine-finishing of Steels, Stainless steels and Super-alloys. It features positive rake angle without T-land. It's also conditionally suitable for Non-ferrous alloys and Hard materials.

DCGT 11T304E-NF1:T6310	● 0.4	145	0.10	0.8	100	0.09	0.8	-	-	-	435	0.12	0.8	40	0.07	0.6	25	0.07	0.3
DCGT 11T304E-NF1:T7325	● 0.4	165	0.10	0.8	125	0.09	0.8	-	-	-	-	-	-	50	0.07	0.6	-	-	-
DCGT 11T308E-NF1:T6310	● 0.8	155	0.14	0.8	110	0.13	0.8	-	-	-	465	0.17	0.8	45	0.13	0.6	30	0.10	0.7
DCGT 11T308E-NF1:T7325	● 0.8	180	0.14	0.8	140	0.13	0.8	-	-	-	-	-	-	55	0.13	0.6	-	-	-

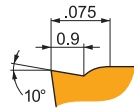
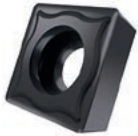

NF1 chip breaker is sharp and designed for fine-finishing of Steels, Stainless steels and Super-alloys. It features positive rake angle without T-land. It's also conditionally suitable for Non-ferrous alloys and Hard materials.

SCGT 09T308E-NF1:T6310	● 0.8	200	0.14	1.2	140	0.13	1.2	-	-	-	600	0.17	1.2	60	0.13	1.0	40	0.10	0.7
SCGT 120408E-NF1:T6310	● 0.8	180	0.18	1.4	125	0.16	1.4	-	-	-	540	0.22	1.4	50	0.16	1.1	35	0.13	0.7
SCGT 120408E-NF1:T7325	● 0.8	205	0.18	1.4	155	0.16	1.4	-	-	-	-	-	-	65	0.16	1.1	-	-	-

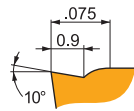

NF1 chip breaker is sharp and designed for fine-finishing of Steels, Stainless steels and Super-alloys. It features positive rake angle without T-land. It's also conditionally suitable for Non-ferrous alloys and Hard materials.

TCGT 110204E-NF1:T6310	● 0.4	155	0.10	0.8	110	0.09	0.8	-	-	-	465	0.12	0.8	45	0.08	0.6	30	0.08	0.3
------------------------	-------	-----	------	-----	-----	------	-----	---	---	---	-----	------	-----	----	------	-----	----	------	-----

SF2





SF2 chip breaker is sharp and designed for fine-finishing of Stainless steels and Super-alloys. It features highly positive rake angle without T-land. It's also conditionally suitable for Steels and Non-ferrous alloys.

PRAMET

ECGT

	IC (mm)	D1 (mm)	L (mm)	S (mm)
0602	6.350	2.80	6.50	2.38
0803	7.940	3.40	8.20	3.18

VCGT

	IC (mm)	D1 (mm)	L (mm)	S (mm)
1303	7.940	3.40	13.80	3.18

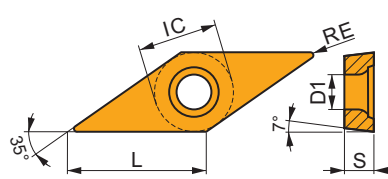
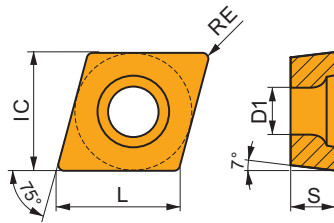

Suitability and starting values for cutting speed (vc), feed (f) and depth of cut (ap). Refer to our Machining Calculator app for further calculations.

Product	RE (mm)	P			M			K			N			S			H		
		vc (m/min)	f (mm/rev)	ap (mm)	vc (m/min)	f (mm/rev)	ap (mm)	vc (m/min)	f (mm/rev)	ap (mm)	vc (m/min)	f (mm/rev)	ap (mm)	vc (m/min)	f (mm/rev)	ap (mm)	vc (m/min)	f (mm/rev)	ap (mm)
	● 0.2	–	–	–	■ 105	0.05	1.0	–	–	–	■ 525	0.06	1.0	■ 50	0.04	0.8	–	–	–
ECGT 060202E-SF2:T6310	● 0.2	■ 185	0.05	1.0	■ 130	0.05	1.0	–	–	–	■ 555	0.06	1.0	■ 55	0.04	0.8	–	–	–
ECGT 060204E-SF2:H07	● 0.4	–	–	–	■ 85	0.09	1.0	–	–	–	■ 430	0.12	1.0	■ 40	0.07	0.8	–	–	–
ECGT 060204E-SF2:T6310	● 0.4	■ 160	0.10	1.0	■ 115	0.09	1.0	–	–	–	■ 480	0.12	1.0	■ 45	0.07	0.8	–	–	–
ECGT 080302E-SF2:H07	● 0.2	–	–	–	■ 105	0.05	1.0	–	–	–	■ 525	0.06	1.0	■ 50	0.04	0.8	–	–	–
ECGT 080302E-SF2:T6310	● 0.2	■ 185	0.05	1.0	■ 130	0.05	1.0	–	–	–	■ 555	0.06	1.0	■ 55	0.04	0.8	–	–	–
ECGT 080304E-SF2:H07	● 0.4	–	–	–	■ 85	0.09	1.0	–	–	–	■ 430	0.12	1.0	■ 40	0.07	0.8	–	–	–
ECGT 080304E-SF2:T6310	● 0.4	■ 160	0.10	1.0	■ 115	0.09	1.0	–	–	–	■ 480	0.12	1.0	■ 45	0.07	0.8	–	–	–

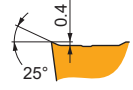



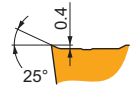

SF2 chip breaker is sharp and designed for fine-finishing of Stainless steels and Super-alloys. It features highly positive rake angle without T-land. It's also conditionally suitable for Steels and Non-ferrous alloys.

ECGT 060202E-SF2:H07	● 0.2	–	–	–	■ 105	0.05	1.0	–	–	–	■ 525	0.06	1.0	■ 50	0.04	0.8	–	–	–
ECGT 060202E-SF2:T6310	● 0.2	■ 185	0.05	1.0	■ 130	0.05	1.0	–	–	–	■ 555	0.06	1.0	■ 55	0.04	0.8	–	–	–
ECGT 060204E-SF2:H07	● 0.4	–	–	–	■ 85	0.09	1.0	–	–	–	■ 430	0.12	1.0	■ 40	0.07	0.8	–	–	–
ECGT 060204E-SF2:T6310	● 0.4	■ 160	0.10	1.0	■ 115	0.09	1.0	–	–	–	■ 480	0.12	1.0	■ 45	0.07	0.8	–	–	–
ECGT 080302E-SF2:H07	● 0.2	–	–	–	■ 105	0.05	1.0	–	–	–	■ 525	0.06	1.0	■ 50	0.04	0.8	–	–	–
ECGT 080302E-SF2:T6310	● 0.2	■ 185	0.05	1.0	■ 130	0.05	1.0	–	–	–	■ 555	0.06	1.0	■ 55	0.04	0.8	–	–	–
ECGT 080304E-SF2:H07	● 0.4	–	–	–	■ 85	0.09	1.0	–	–	–	■ 430	0.12	1.0	■ 40	0.07	0.8	–	–	–
ECGT 080304E-SF2:T6310	● 0.4	■ 160	0.10	1.0	■ 115	0.09	1.0	–	–	–	■ 480	0.12	1.0	■ 45	0.07	0.8	–	–	–







SF2 chip breaker is sharp and designed for fine-finishing of Stainless steels and Super-alloys. It features highly positive rake angle without T-land. It's also conditionally suitable for Steels and Non-ferrous alloys.

VCGT 130301E-SF2:H07	● 0.1	–	–	–	■ 80	0.05	1.0	–	–	–	■ 405	0.06	1.0	■ 40	0.04	0.8	–	–	–
VCGT 130301E-SF2:T6310	● 0.1	■ 140	0.05	1.0	■ 100	0.05	1.0	–	–	–	■ 420	0.06	1.0	■ 40	0.04	0.8	–	–	–
VCGT 130302E-SF2:H07	● 0.2	–	–	–	■ 80	0.05	1.0	–	–	–	■ 405	0.06	1.0	■ 40	0.04	0.8	–	–	–
VCGT 130302E-SF2:HF7	● 0.2	–	–	–	■ 90	0.05	1.0	–	–	–	■ 450	0.06	1.0	–	–	–	–	–	–
VCGT 130302E-SF2:T6310	● 0.2	■ 140	0.05	1.0	■ 100	0.05	1.0	–	–	–	■ 420	0.06	1.0	■ 40	0.04	0.8	–	–	–
VCGT 130304E-SF2:H07	● 0.4	–	–	–	■ 65	0.09	1.0	–	–	–	■ 335	0.12	1.0	■ 30	0.07	0.8	–	–	–
VCGT 130304E-SF2:HF7	● 0.4	–	–	–	■ 75	0.09	1.0	–	–	–	■ 375	0.12	1.0	–	–	–	–	–	–
VCGT 130304E-SF2:T6310	● 0.4	■ 125	0.10	1.0	■ 90	0.09	1.0	–	–	–	■ 375	0.12	1.0	■ 35	0.07	0.8	–	–	–
VCGT 130308E-SF2:HF7	● 0.8	–	–	–	■ 85	0.09	1.0	–	–	–	■ 435	0.12	1.0	–	–	–	–	–	–
VCGT 130308E-SF2:T6310	● 0.8	■ 145	0.10	1.0	■ 100	0.09	1.0	–	–	–	■ 435	0.12	1.0	■ 40	0.08	0.8	–	–	–

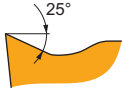
AL



AL chip breaker is sharp and the first choice for all-around machining of Non-ferrous alloys. It features highly positive rake angle without T-land. It's also conditionally suitable for Super-alloys.



CCGT

	IC (mm)	D1 (mm)	L (mm)	S (mm)
0602	6.350	2.80	6.40	2.38
0803-AL	7.940	3.40	8.10	3.43
09T3	9.525	4.40	9.70	3.97
1204	12.700	5.50	12.90	4.76

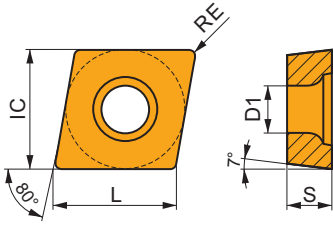

DCGT

	IC (mm)	D1 (mm)	L (mm)	S (mm)
0702	6.350	2.80	7.80	2.38
11T3	9.525	4.40	11.60	3.97

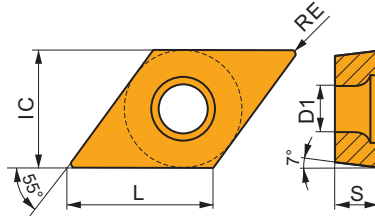

RCGT

	IC (mm)	D1 (mm)	L (mm)	S (mm)
0803	8.000	3.40	3.18	3.97
1003	10.000	4.40	3.18	

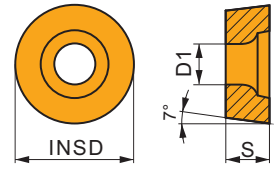

SCGT

	IC (mm)	D1 (mm)	L (mm)	S (mm)
1204	12.700	5.50	12.70	4.76

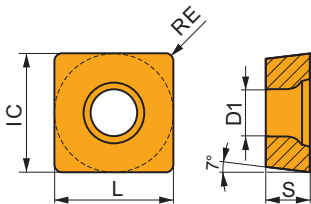

TCGT

	IC (mm)	D1 (mm)	L (mm)	S (mm)
0902	5.560	2.50	9.60	2.38
1102	6.350	2.80	11.00	2.38
16T3	9.525	4.40	16.50	3.97

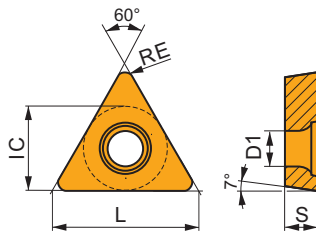

VCGT

	IC (mm)	D1 (mm)	L (mm)	S (mm)
0702	3.970	2.20	6.90	2.38
1103	6.350	2.80	11.10	3.18
1303-AL	7.940	3.40	13.80	3.43
1604	9.525	4.40	16.60	4.76

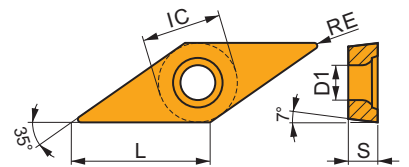

WCGT

	IC (mm)	D1 (mm)	L (mm)	S (mm)
06T3	9.525	4.40	6.50	3.97
0804	12.700	5.50	8.70	4.76

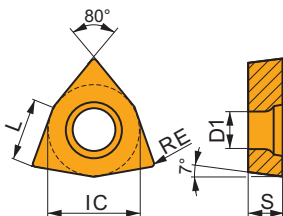

Suitability and starting values for cutting speed (vc), feed (f) and depth of cut (ap). Refer to our Machining Calculator app for further calculations.

Product	RE (mm)	P			M			K			N			S			H		
		vc (m/min)	f (mm/rev)	ap (mm)	vc (m/min)	f (mm/rev)	ap (mm)	vc (m/min)	f (mm/rev)	ap (mm)	vc (m/min)	f (mm/rev)	ap (mm)	vc (m/min)	f (mm/rev)	ap (mm)	vc (m/min)	f (mm/rev)	ap (mm)

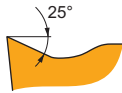
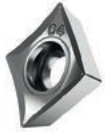

AL chip breaker is sharp and the first choice for all-around machining of Non-ferrous alloys. It features highly positive rake angle without T-land. It's also conditionally suitable for Super-alloys.

CCGT 060202F-AL:HF7	● 0.2	-	-	-	-	-	-	-	-	■ 450	0.12	1.0	-	-	-	-	-	-
CCGT 060202F-AL:T0315	● 0.2	-	-	-	-	-	-	-	-	■ 645	0.12	1.0	-	-	-	-	-	-
CCGT 060204F-AL:HF7	● 0.4	-	-	-	-	-	-	-	-	■ 360	0.24	1.0	-	-	-	-	-	-
CCGT 060204F-AL:T0315	● 0.4	-	-	-	-	-	-	-	-	■ 525	0.24	1.0	-	-	-	-	-	-
CCGT 080302F-AL:T0315	● 0.2	-	-	-	-	-	-	-	-	■ 645	0.12	1.0	-	-	-	-	-	-
CCGT 080304F-AL:HF7	● 0.4	-	-	-	-	-	-	-	-	■ 360	0.24	1.0	-	-	-	-	-	-
CCGT 080304F-AL:T0315	● 0.4	-	-	-	-	-	-	-	-	■ 525	0.24	1.0	-	-	-	-	-	-
CCGT 09T302F-AL:HF7	● 0.2	-	-	-	-	-	-	-	-	■ 450	0.12	1.0	-	-	-	-	-	-
CCGT 09T302F-AL:T0315	● 0.2	-	-	-	-	-	-	-	-	■ 645	0.12	1.0	-	-	-	-	-	-
CCGT 09T304F-AL:HF7	● 0.4	-	-	-	-	-	-	-	-	■ 345	0.24	1.5	-	-	-	-	-	-
CCGT 09T304F-AL:T0315	● 0.4	-	-	-	-	-	-	-	-	■ 495	0.24	1.5	-	-	-	-	-	-
CCGT 09T308F-AL:HF7	● 0.8	-	-	-	-	-	-	-	-	■ 315	0.48	1.5	-	-	-	-	-	-
CCGT 09T308F-AL:T0315	● 0.8	-	-	-	-	-	-	-	-	■ 450	0.48	1.5	-	-	-	-	-	-
CCGT 120404F-AL:HF7	● 0.4	-	-	-	-	-	-	-	-	■ 330	0.24	2.4	-	-	-	-	-	-
CCGT 120404F-AL:T0315	● 0.4	-	-	-	-	-	-	-	-	■ 480	0.24	2.4	-	-	-	-	-	-
CCGT 120408F-AL:HF7	● 0.8	-	-	-	-	-	-	-	-	■ 300	0.48	2.4	-	-	-	-	-	-
CCGT 120408F-AL:T0315	● 0.8	-	-	-	-	-	-	-	-	■ 435	0.48	2.4	-	-	-	-	-	-

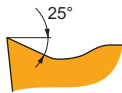

AL chip breaker is sharp and the first choice for all-around machining of Non-ferrous alloys. It features highly positive rake angle without T-land. It's also conditionally suitable for Super-alloys.

DCGT 070202F-AL:HF7	● 0.2	-	-	-	-	-	-	-	-	■ 360	0.12	1.0	-	-	-	-	-	-
DCGT 070202F-AL:T0315	● 0.2	-	-	-	-	-	-	-	-	■ 510	0.12	1.0	-	-	-	-	-	-
DCGT 070204F-AL:HF7	● 0.4	-	-	-	-	-	-	-	-	■ 285	0.24	1.0	-	-	-	-	-	-
DCGT 070204F-AL:T0315	● 0.4	-	-	-	-	-	-	-	-	■ 420	0.24	1.0	-	-	-	-	-	-
DCGT 11T302F-AL:HF7	● 0.2	-	-	-	-	-	-	-	-	■ 345	0.12	1.5	-	-	-	-	-	-
DCGT 11T302F-AL:T0315	● 0.2	-	-	-	-	-	-	-	-	■ 495	0.12	1.5	-	-	-	-	-	-
DCGT 11T304F-AL:HF7	● 0.4	-	-	-	-	-	-	-	-	■ 270	0.24	1.5	-	-	-	-	-	-
DCGT 11T304F-AL:T0315	● 0.4	-	-	-	-	-	-	-	-	■ 390	0.24	1.5	-	-	-	-	-	-
DCGT 11T308F-AL:HF7	● 0.8	-	-	-	-	-	-	-	-	■ 255	0.48	1.5	-	-	-	-	-	-
DCGT 11T308F-AL:T0315	● 0.8	-	-	-	-	-	-	-	-	■ 360	0.48	1.5	-	-	-	-	-	-

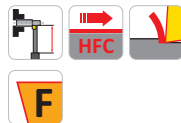
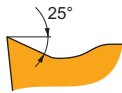

AL chip breaker is sharp and the first choice for all-around machining of Non-ferrous alloys. It features highly positive rake angle without T-land. It's also conditionally suitable for Super-alloys.

RCGT 0803MOF-AL:HF7	● -	-	-	-	-	-	-	-	-	■ 285	1.20	1.0	-	-	-	-	-	-
RCGT 0803MOF-AL:T0315	● -	-	-	-	-	-	-	-	-	■ 420	1.20	1.0	-	-	-	-	-	-
RCGT 1003MOF-AL:HF7	● -	-	-	-	-	-	-	-	-	■ 255	1.50	1.0	-	-	-	-	-	-
RCGT 1003MOF-AL:T0315	● -	-	-	-	-	-	-	-	-	■ 390	1.50	1.0	-	-	-	-	-	-

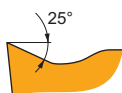
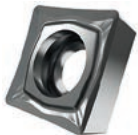

AL chip breaker is sharp and the first choice for all-around machining of Non-ferrous alloys. It features highly positive rake angle without T-land. It's also conditionally suitable for Super-alloys.

SCGT 120408F-AL:HF7	● 0.8	-	-	-	-	-	-	-	-	■ 315	0.48	2.0	-	-	-	-	-	-
SCGT 120408F-AL:T0315	● 0.8	-	-	-	-	-	-	-	-	■ 465	0.48	2.0	-	-	-	-	-	-

Suitability and starting values for cutting speed (vc), feed (f) and depth of cut (ap). Refer to our Machining Calculator app for further calculations.

Product	RE (mm)	P			M			K			N			S			H		
		vc (m/min)	f (mm/rev)	ap (mm)	vc (m/min)	f (mm/rev)	ap (mm)	vc (m/min)	f (mm/rev)	ap (mm)	vc (m/min)	f (mm/rev)	ap (mm)	vc (m/min)	f (mm/rev)	ap (mm)	vc (m/min)	f (mm/rev)	ap (mm)

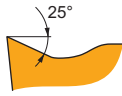

AL chip breaker is sharp and the first choice for all-around machining of Non-ferrous alloys. It features highly positive rake angle without T-land. It's also conditionally suitable for Super-alloys.

TCGT 090202F-AL-HF7	●	0.2	-	-	-	-	-	-	-	■	375	0.12	1.0	-	-	-	-	-	-
TCGT 090202F-AL:T0315	●	0.2	-	-	-	-	-	-	-	■	555	0.12	1.0	-	-	-	-	-	-
TCGT 090204F-AL-HF7	●	0.4	-	-	-	-	-	-	-	■	300	0.24	1.0	-	-	-	-	-	-
TCGT 090204F-AL:T0315	●	0.4	-	-	-	-	-	-	-	■	450	0.24	1.0	-	-	-	-	-	-
TCGT 110202F-AL-HF7	●	0.2	-	-	-	-	-	-	-	■	360	0.12	1.5	-	-	-	-	-	-
TCGT 110202F-AL:T0315	●	0.2	-	-	-	-	-	-	-	■	525	0.12	1.5	-	-	-	-	-	-
TCGT 110204F-AL-HF7	●	0.4	-	-	-	-	-	-	-	■	285	0.24	1.5	-	-	-	-	-	-
TCGT 110204F-AL:T0315	●	0.4	-	-	-	-	-	-	-	■	420	0.24	1.5	-	-	-	-	-	-
TCGT 110208F-AL-HF7	●	0.8	-	-	-	-	-	-	-	■	270	0.48	1.5	-	-	-	-	-	-
TCGT 16T304F-AL-HF7	●	0.4	-	-	-	-	-	-	-	■	285	0.24	2.4	-	-	-	-	-	-
TCGT 16T304F-AL:T0315	●	0.4	-	-	-	-	-	-	-	■	405	0.24	2.4	-	-	-	-	-	-
TCGT 16T308F-AL-HF7	●	0.8	-	-	-	-	-	-	-	■	255	0.48	2.4	-	-	-	-	-	-
TCGT 16T308F-AL:T0315	●	0.8	-	-	-	-	-	-	-	■	360	0.48	2.4	-	-	-	-	-	-

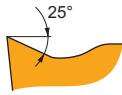

AL chip breaker is sharp and the first choice for all-around machining of Non-ferrous alloys. It features highly positive rake angle without T-land. It's also conditionally suitable for Super-alloys.

VCGT 070202F-AL-HF7	●	0.2	-	-	-	-	-	-	-	■	315	0.12	1.0	-	-	-	-	-	-
VCGT 110302F-AL-HF7	●	0.2	-	-	-	-	-	-	-	■	300	0.12	1.5	-	-	-	-	-	-
VCGT 110302F-AL:T0315	●	0.2	-	-	-	-	-	-	-	■	465	0.12	0.8	-	-	-	-	-	-
VCGT 110304F-AL-HF7	●	0.4	-	-	-	-	-	-	-	■	240	0.24	1.5	-	-	-	-	-	-
VCGT 110304F-AL:T0315	●	0.4	-	-	-	-	-	-	-	■	375	0.24	0.8	-	-	-	-	-	-
VCGT 130302F-AL-HF7	●	0.2	-	-	-	-	-	-	-	■	285	0.12	1.7	-	-	-	-	-	-
VCGT 130302F-AL:T0315	●	0.2	-	-	-	-	-	-	-	■	420	0.12	1.7	-	-	-	-	-	-
VCGT 130304F-AL-HF7	●	0.4	-	-	-	-	-	-	-	■	240	0.24	1.7	-	-	-	-	-	-
VCGT 130304F-AL:T0315	●	0.4	-	-	-	-	-	-	-	■	345	0.24	1.7	-	-	-	-	-	-
VCGT 130308F-AL-HF7	●	0.8	-	-	-	-	-	-	-	■	210	0.48	1.7	-	-	-	-	-	-
VCGT 130308F-AL:T0315	●	0.8	-	-	-	-	-	-	-	■	315	0.48	1.7	-	-	-	-	-	-
VCGT 160402F-AL-HF7	●	0.2	-	-	-	-	-	-	-	■	285	0.12	2.4	-	-	-	-	-	-
VCGT 160402F-AL:T0315	●	0.2	-	-	-	-	-	-	-	■	420	0.12	2.4	-	-	-	-	-	-
VCGT 160404F-AL-HF7	●	0.4	-	-	-	-	-	-	-	■	225	0.24	2.4	-	-	-	-	-	-
VCGT 160404F-AL:T0315	●	0.4	-	-	-	-	-	-	-	■	330	0.24	2.4	-	-	-	-	-	-
VCGT 160408F-AL-HF7	●	0.8	-	-	-	-	-	-	-	■	210	0.48	2.4	-	-	-	-	-	-
VCGT 160408F-AL:T0315	●	0.8	-	-	-	-	-	-	-	■	300	0.48	2.4	-	-	-	-	-	-
VCGT 160412F-AL-HF7	●	1.2	-	-	-	-	-	-	-	■	180	0.72	2.4	-	-	-	-	-	-
VCGT 160412F-AL:T0315	●	1.2	-	-	-	-	-	-	-	■	270	0.72	2.4	-	-	-	-	-	-

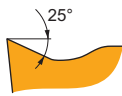
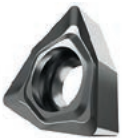

AL chip breaker is sharp and the first choice for all-around machining of Non-ferrous alloys. It features highly positive rake angle without T-land. It's also conditionally suitable for Super-alloys.

WCGT 06T302F-AL-HF7	●	0.2	-	-	-	-	-	-	-	■	450	0.12	1.0	-	-	-	-	-	-
WCGT 06T304F-AL-HF7	●	0.4	-	-	-	-	-	-	-	■	360	0.24	1.0	-	-	-	-	-	-
WCGT 06T304F-AL:T0315	●	0.4	-	-	-	-	-	-	-	■	525	0.24	1.0	-	-	-	-	-	-
WCGT 06T308F-AL-HF7	●	0.8	-	-	-	-	-	-	-	■	315	0.48	1.5	-	-	-	-	-	-
WCGT 080412F-AL-HF7	●	1.2	-	-	-	-	-	-	-	■	255	0.72	2.4	-	-	-	-	-	-

**JQ
JR
JZ**

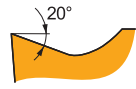

JQ, JR, JZ chip breaker is sharp and designed for fine-finishing of Steels. It features highly positive rake angle without T-land. It's also conditionally suitable for Stainless steels.



CPGX

	IC (mm)	D1 (mm)	L (mm)	S (mm)
0602	6.350	2.80	6.40	2.38
0803	7.940	3.40	8.10	3.18
09T3	9.525	4.40	9.70	3.97

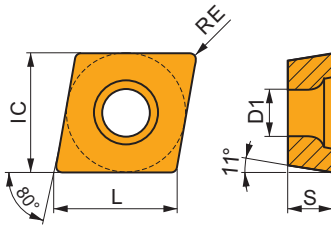

EPGX

	IC (mm)	D1 (mm)	L (mm)	S (mm)
0502	5.560	2.50	5.70	2.38

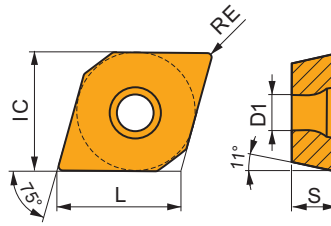

TPGX

	IC (mm)	D1 (mm)	L (mm)	S (mm)
0902	5.560	2.50	9.60	2.38
1102	6.350	2.80	11.00	2.38
16T3	9.525	4.40	16.50	3.97

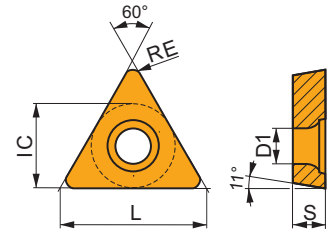





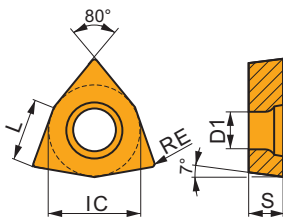



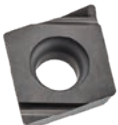
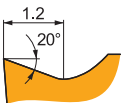

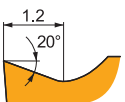

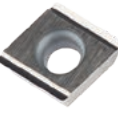
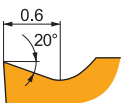

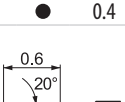

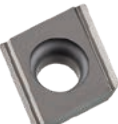
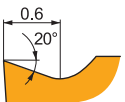

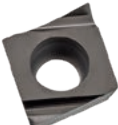
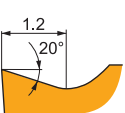

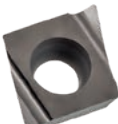
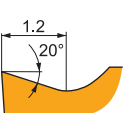
WCGX

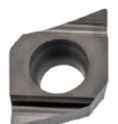
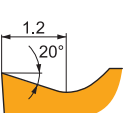
	IC (mm)	D1 (mm)	L (mm)	S (mm)
0201	3.970	2.20	2.70	1.59

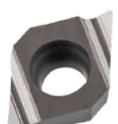
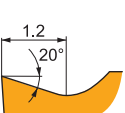

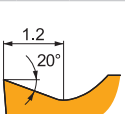
Suitability and starting values for cutting speed (vc), feed (f) and depth of cut (ap). Refer to our Machining Calculator app for further calculations.

Product	RE (mm)	P			M			K			N			S			H		
		vc (m/min)	f (mm/rev)	ap (mm)	vc (m/min)	f (mm/rev)	ap (mm)	vc (m/min)	f (mm/rev)	ap (mm)	vc (m/min)	f (mm/rev)	ap (mm)	vc (m/min)	f (mm/rev)	ap (mm)	vc (m/min)	f (mm/rev)	ap (mm)
   <p>JQ chip breaker is sharp and designed for fine-finishing of Steels. It features highly positive rake angle without T-land. It's also conditionally suitable for Stainless steels.</p>	●	0.4	350	0.06	0.5	210	0.05	0.5	—	—	—	—	—	—	—	—	—	—	
	CPGX 080304FR-JQ:TT010	●	0.4	350	0.06	0.5	210	0.05	0.5	—	—	—	—	—	—	—	—	—	—
   <p>JQ chip breaker is sharp and designed for fine-finishing of Steels. It features highly positive rake angle without T-land. It's also conditionally suitable for Stainless steels.</p>	●	0.4	350	0.06	0.5	210	0.05	0.5	—	—	—	—	—	—	—	—	—	—	
	CPGX 080304FL-JQ:TT010	●	0.4	350	0.06	0.5	210	0.05	0.5	—	—	—	—	—	—	—	—	—	—
   <p>JR chip breaker is sharp and designed for fine-finishing of Steels. It features highly positive rake angle without T-land. It's also conditionally suitable for Stainless steels.</p>	●	0.4	350	0.06	0.5	210	0.05	0.5	—	—	—	—	—	—	—	—	—	—	
	CPGX 060204FR-JR:TT010	●	0.4	350	0.06	0.5	210	0.05	0.5	—	—	—	—	—	—	—	—	—	—
   <p>JR chip breaker is sharp and designed for fine-finishing of Steels. It features highly positive rake angle without T-land. It's also conditionally suitable for Stainless steels.</p>	●	0.4	350	0.06	0.5	210	0.05	0.5	—	—	—	—	—	—	—	—	—	—	
	CPGX 080304FR-JR:TT010	●	0.4	350	0.06	0.5	210	0.05	0.5	—	—	—	—	—	—	—	—	—	—
   <p>JZ chip breaker is sharp and designed for fine-finishing of Steels. It features highly positive rake angle without T-land. It's also conditionally suitable for Stainless steels.</p>	●	0.4	350	0.06	0.5	210	0.05	0.5	—	—	—	—	—	—	—	—	—	—	
	CPGX 060204FL-JR:TT010	●	0.4	350	0.06	0.5	210	0.05	0.5	—	—	—	—	—	—	—	—	—	—
   <p>JZ chip breaker is sharp and designed for fine-finishing of Steels. It features highly positive rake angle without T-land. It's also conditionally suitable for Stainless steels.</p>	●	0.2	330	0.06	0.5	195	0.05	0.5	—	—	—	—	—	—	—	—	—	—	
	CPGX 060202FR-JZ:TT010	●	0.2	330	0.06	0.5	195	0.05	0.5	—	—	—	—	—	—	—	—	—	—
   <p>JZ chip breaker is sharp and designed for fine-finishing of Steels. It features highly positive rake angle without T-land. It's also conditionally suitable for Stainless steels.</p>	●	0.2	330	0.06	0.5	195	0.05	0.5	—	—	—	—	—	—	—	—	—	—	
	CPGX 060202FL-JZ:TT010	●	0.2	330	0.06	0.5	195	0.05	0.5	—	—	—	—	—	—	—	—	—	—
   <p>JZ chip breaker is sharp and designed for fine-finishing of Steels. It features highly positive rake angle without T-land. It's also conditionally suitable for Stainless steels.</p>	●	0.2	295	0.06	0.5	175	0.05	0.5	—	—	—	—	—	—	—	—	—	—	
	EPGX 050202FR-JZ:TT010	●	0.2	295	0.06	0.5	175	0.05	0.5	—	—	—	—	—	—	—	—	—	—
   <p>JZ chip breaker is sharp and designed for fine-finishing of Steels. It features highly positive rake angle without T-land. It's also conditionally suitable for Stainless steels.</p>	●	0.2	295	0.06	0.5	175	0.05	0.5	—	—	—	—	—	—	—	—	—	—	
	EPGX 050202FL-JZ:TT010	●	0.2	295	0.06	0.5	175	0.05	0.5	—	—	—	—	—	—	—	—	—	—
   <p>JQ chip breaker is sharp and designed for fine-finishing of Steels. It features highly positive rake angle without T-land. It's also conditionally suitable for Stainless steels.</p>	●	0.4	295	0.06	0.5	175	0.05	0.5	—	—	—	—	—	—	—	—	—	—	
	TPGX 110204FR-JQ:TT010	●	0.4	295	0.06	0.5	175	0.05	0.5	—	—	—	—	—	—	—	—	—	—

Suitability and starting values for cutting speed (vc), feed (f) and depth of cut (ap). Refer to our Machining Calculator app for further calculations.

Product	RE (mm)	P			M			K			N			S			H		
		vc (m/min)	f (mm/rev)	ap (mm)	vc (m/min)	f (mm/rev)	ap (mm)	vc (m/min)	f (mm/rev)	ap (mm)	vc (m/min)	f (mm/rev)	ap (mm)	vc (m/min)	f (mm/rev)	ap (mm)	vc (m/min)	f (mm/rev)	ap (mm)
<p>1.2 20°</p> <p>JQ chip breaker is sharp and designed for fine-finishing of Steels. It features highly positive rake angle without T-land. It's also conditionally suitable for Stainless steels.</p>																			
TPGX 090204FL-JQ:TT010	● 0.4	■ 295	■ 0.06	■ 0.5	■ 175	■ 0.05	■ 0.5	■ -	■ -	■ -	■ -	■ -	■ -	■ -	■ -	■ -	■ -	■ -	■ -
TPGX 110204FL-JQ:TT010	● 0.4	■ 295	■ 0.06	■ 0.5	■ 175	■ 0.05	■ 0.5	■ -	■ -	■ -	■ -	■ -	■ -	■ -	■ -	■ -	■ -	■ -	■ -
<p>0.6 20°</p> <p>JR chip breaker is sharp and designed for fine-finishing of Steels. It features highly positive rake angle without T-land. It's also conditionally suitable for Stainless steels.</p>																			
TPGX 16T304FL-JR:TT010	● 0.4	■ 295	■ 0.06	■ 0.5	■ 175	■ 0.05	■ 0.5	■ -	■ -	■ -	■ -	■ -	■ -	■ -	■ -	■ -	■ -	■ -	■ -
<p>1.2 20°</p> <p>JZ chip breaker is sharp and designed for fine-finishing of Steels. It features highly positive rake angle without T-land. It's also conditionally suitable for Stainless steels.</p>																			
TPGX 090202FR-JZ:TT010	● 0.2	■ 280	■ 0.06	■ 0.5	■ 165	■ 0.05	■ 0.5	■ -	■ -	■ -	■ -	■ -	■ -	■ -	■ -	■ -	■ -	■ -	■ -
<p>1.2 20°</p> <p>JZ chip breaker is sharp and designed for fine-finishing of Steels. It features highly positive rake angle without T-land. It's also conditionally suitable for Stainless steels.</p>																			
TPGX 090202FL-JZ:TT010	● 0.2	■ 280	■ 0.06	■ 0.5	■ 165	■ 0.05	■ 0.5	■ -	■ -	■ -	■ -	■ -	■ -	■ -	■ -	■ -	■ -	■ -	■ -
<p>1.2 20°</p> <p>JZ chip breaker is sharp and designed for fine-finishing of Steels. It features highly positive rake angle without T-land. It's also conditionally suitable for Stainless steels.</p>																			
WCGX 020102FL-JZ:TT010	● 0.2	■ 330	■ 0.06	■ 0.5	■ 195	■ 0.05	■ 0.5	■ -	■ -	■ -	■ -	■ -	■ -	■ -	■ -	■ -	■ -	■ -	■ -

FINISHING – NAVIGATOR

FM			<p>FM chip breaker is versatile and the first choice for finishing of Steels. It features positive rake angle and positive, narrow T-land. It's also suitable for Stainless steels, and conditionally for Cast irons and Non-ferrous alloys.</p>
NF2			<p>NF2 chip breaker is sharp and the first choice for finishing of Stainless steels. It features positive rake angle without T-land. It's also suitable for Super-alloys, and conditionally for Steels, Cast irons and Non-ferrous alloys.</p>
UR			<p>UR chip breaker is versatile and the first choice for finishing of Cast irons. It features positive rake angle without T-land. It's also suitable for Steels, and conditionally for Stainless steels.</p>
W-FM			<p>W-FM chip breaker has wiper edge and is designed for finishing of Steels, Stainless steels and Cast irons. It features positive rake angle and positive, narrow T-land.</p>
W-UR			<p>W-UR chip breaker has wiper edge and is designed for finishing of Steels and Cast irons. It features positive rake angle without T-land. It's also conditionally suitable for Stainless steels.</p>

FM

FM chip breaker is versatile and the first choice for finishing of Steels. It features positive rake angle and positive, narrow T-land. It's also suitable for Stainless steels, and conditionally for Cast irons and Non-ferrous alloys.

PRAMET

CCMT

	IC	D1	L	S
	(mm)	(mm)	(mm)	(mm)
0602	6.350	2.80	6.40	2.38
09T3	9.525	4.40	9.70	3.97
1204	12.700	5.50	12.90	4.76

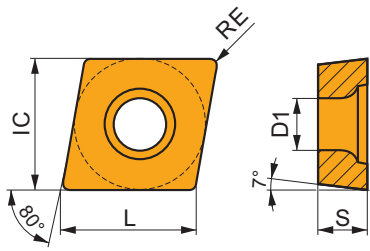

DCMT

	IC	D1	L	S
	(mm)	(mm)	(mm)	(mm)
0702	6.350	2.80	7.80	2.38
11T3	9.525	4.40	11.60	3.97

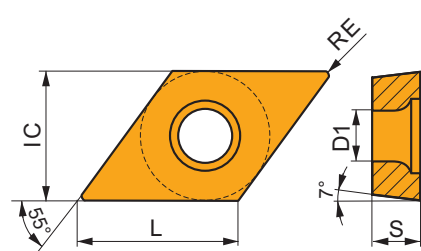

RCMT

	IC	D1	S
	(mm)	(mm)	(mm)
0602	6.000	2.80	2.38
0803	8.000	3.40	3.18
10T3	10.000	4.40	3.97
1204	12.000	4.40	4.76

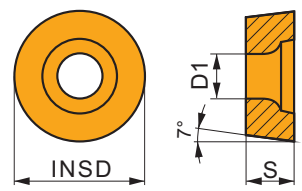

SCMT

	IC	D1	L	S
	(mm)	(mm)	(mm)	(mm)
09T3	9.525	4.40	9.53	3.97
1204	12.700	5.50	12.70	4.76

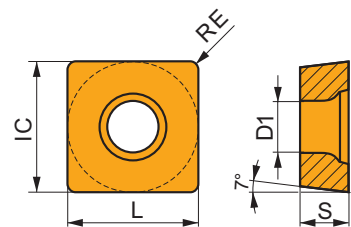

TCMT

	IC	D1	L	S
	(mm)	(mm)	(mm)	(mm)
1102	6.350	2.80	11.00	2.38
16T3	9.525	4.40	16.50	3.97

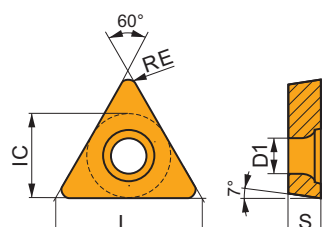

VBMT

	IC	D1	L	S
	(mm)	(mm)	(mm)	(mm)
1103	6.350	2.80	11.10	3.18
1604	9.525	4.40	16.60	4.76

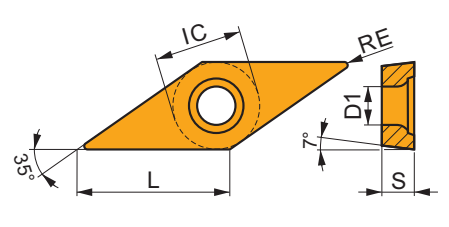

VCMT

	IC	D1	L	S
	(mm)	(mm)	(mm)	(mm)
1604	9.525	4.40	16.60	4.76

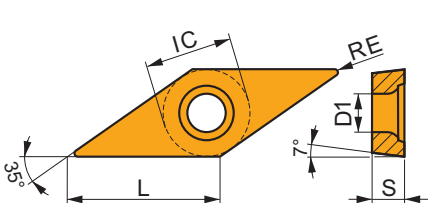

WCMT

	IC	D1	L	S
	(mm)	(mm)	(mm)	(mm)
06T3	9.525	4.40	6.50	3.97
0804	12.700	5.50	8.70	4.76

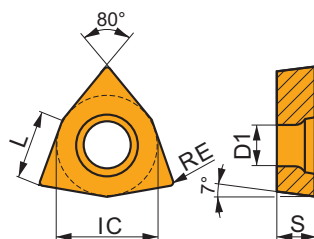

Suitability and starting values for cutting speed (vc), feed (f) and depth of cut (ap). Refer to our Machining Calculator app for further calculations.

Product	RE (mm)	P			M			K			N			S			H		
		vc (m/min)	f (mm/rev)	ap (mm)	vc (m/min)	f (mm/rev)	ap (mm)	vc (m/min)	f (mm/rev)	ap (mm)	vc (m/min)	f (mm/rev)	ap (mm)	vc (m/min)	f (mm/rev)	ap (mm)	vc (m/min)	f (mm/rev)	ap (mm)

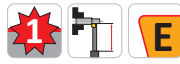
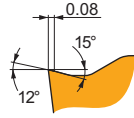
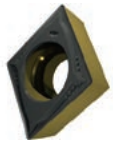

FM chip breaker is versatile and the first choice for finishing of Steels. It features positive rake angle and positive, narrow T-land. It's also suitable for Stainless steels, and conditionally for Cast irons and Non-ferrous alloys.

CCMT 060202E-FM:T7325	●	0.2	210	0.10	1.0	160	0.09	1.0	-	-	-	-	-	-	-	-	-	-
CCMT 060202E-FM:T7335	●	0.2	210	0.10	1.0	160	0.09	1.0	-	-	-	-	-	-	-	-	-	-
CCMT 060202E-FM:T8315	●	0.2	195	0.10	1.0	115	0.09	1.0	185	0.10	1.0	585	0.12	1.0	-	-	-	-
CCMT 060202E-FM:T8415	●	0.2	240	0.10	1.0	125	0.09	1.0	215	0.10	1.0	600	0.12	1.0	-	-	-	-
CCMT 060202E-FM:T8430	●	0.2	230	0.10	1.0	125	0.09	1.0	185	0.10	1.0	630	0.12	1.0	-	-	-	-
CCMT 060202E-FM:T9325	●	0.2	285	0.10	1.0	170	0.09	1.0	270	0.10	1.0	-	-	-	-	-	-	-
CCMT 060202E-FM:T9415	●	0.2	335	0.10	1.0	-	-	-	315	0.10	1.0	-	-	-	-	-	-	-
CCMT 060204E-FM:T7325	●	0.4	200	0.15	1.0	155	0.15	1.0	-	-	-	-	-	-	-	-	-	-
CCMT 060204E-FM:T7335	●	0.4	195	0.15	1.0	150	0.15	1.0	-	-	-	-	-	-	-	-	-	-
CCMT 060204E-FM:T8315	●	0.4	185	0.15	1.0	110	0.14	1.0	175	0.15	1.0	555	0.18	1.0	-	-	-	-
CCMT 060204E-FM:T8415	●	0.4	225	0.15	1.0	115	0.14	1.0	205	0.15	1.0	570	0.18	1.0	-	-	-	-
CCMT 060204E-FM:T8430	●	0.4	205	0.15	1.0	110	0.14	1.0	170	0.15	1.0	570	0.18	1.0	-	-	-	-
CCMT 060204E-FM:T9315	●	0.4	285	0.15	1.0	-	-	-	270	0.15	1.0	-	-	-	-	-	-	-
CCMT 060204E-FM:T9325	●	0.4	250	0.15	1.0	150	0.15	1.0	235	0.15	1.0	-	-	-	-	-	-	-
CCMT 060204E-FM:T9415	●	0.4	310	0.15	1.0	-	-	-	290	0.15	1.0	-	-	-	-	-	-	-
CCMT 060208E-FM:T7325	●	0.8	220	0.20	1.0	170	0.18	1.0	-	-	-	-	-	-	-	-	-	-
CCMT 060208E-FM:T8430	⊕	0.8	220	0.20	1.0	120	0.18	1.0	180	0.20	1.0	600	0.24	1.0	-	-	-	-
CCMT 060208E-FM:T9325	●	0.8	265	0.20	1.0	155	0.18	1.0	250	0.20	1.0	-	-	-	-	-	-	-
CCMT 060208E-FM:T9415	●	0.8	335	0.20	1.0	-	-	-	315	0.20	1.0	-	-	-	-	-	-	-
CCMT 09T302E-FM:T7325	●	0.2	205	0.10	1.2	155	0.09	1.2	-	-	-	-	-	-	-	-	-	-
CCMT 09T302E-FM:T7335	●	0.2	205	0.10	1.2	155	0.09	1.2	-	-	-	-	-	-	-	-	-	-
CCMT 09T302E-FM:T8315	●	0.2	190	0.10	1.2	110	0.09	1.2	180	0.10	1.2	570	0.12	1.2	-	-	-	-
CCMT 09T302E-FM:T8415	●	0.2	230	0.10	1.2	120	0.09	1.2	210	0.10	1.2	585	0.12	1.2	-	-	-	-
CCMT 09T302E-FM:T8430	●	0.2	225	0.10	1.2	120	0.09	1.2	185	0.10	1.2	615	0.12	1.2	-	-	-	-
CCMT 09T302E-FM:T9325	●	0.2	275	0.10	1.2	165	0.09	1.2	260	0.10	1.2	-	-	-	-	-	-	-
CCMT 09T302E-FM:T9415	●	0.2	330	0.10	1.2	-	-	-	310	0.10	1.2	-	-	-	-	-	-	-
CCMT 09T304E-FM:T7325	●	0.4	195	0.15	1.2	150	0.15	1.2	-	-	-	-	-	-	-	-	-	-
CCMT 09T304E-FM:T7335	●	0.4	190	0.15	1.2	145	0.15	1.2	-	-	-	-	-	-	-	-	-	-
CCMT 09T304E-FM:T8315	●	0.4	180	0.15	1.2	105	0.14	1.2	170	0.15	1.2	540	0.18	1.2	-	-	-	-
CCMT 09T304E-FM:T8415	●	0.4	220	0.15	1.2	115	0.14	1.2	200	0.15	1.2	555	0.18	1.2	-	-	-	-
CCMT 09T304E-FM:T8430	●	0.4	200	0.15	1.2	110	0.14	1.2	165	0.15	1.2	555	0.18	1.2	-	-	-	-
CCMT 09T304E-FM:T9315	●	0.4	275	0.15	1.2	-	-	-	260	0.15	1.2	-	-	-	-	-	-	-
CCMT 09T304E-FM:T9325	●	0.4	245	0.15	1.2	145	0.15	1.2	230	0.15	1.2	-	-	-	-	-	-	-
CCMT 09T304E-FM:T9415	●	0.4	305	0.15	1.2	-	-	-	285	0.15	1.2	-	-	-	-	-	-	-
CCMT 09T308E-FM:T7325	●	0.8	215	0.20	1.2	165	0.18	1.2	-	-	-	-	-	-	-	-	-	-
CCMT 09T308E-FM:T7335	●	0.8	205	0.20	1.2	155	0.18	1.2	-	-	-	-	-	-	-	-	-	-
CCMT 09T308E-FM:T8315	●	0.8	195	0.20	1.2	115	0.18	1.2	185	0.20	1.2	585	0.24	1.2	-	-	-	-
CCMT 09T308E-FM:T8415	●	0.8	240	0.20	1.2	125	0.18	1.2	215	0.20	1.2	600	0.24	1.2	-	-	-	-
CCMT 09T308E-FM:T8430	⊕	0.8	210	0.20	1.2	115	0.18	1.2	175	0.20	1.2	585	0.24	1.2	-	-	-	-
CCMT 09T308E-FM:T9325	●	0.8	260	0.20	1.2	155	0.18	1.2	245	0.20	1.2	-	-	-	-	-	-	-
CCMT 09T308E-FM:T9415	●	0.8	330	0.20	1.2	-	-	-	310	0.20	1.2	-	-	-	-	-	-	-
CCMT 120404E-FM:T7325	●	0.4	190	0.15	1.7	145	0.15	1.7	-	-	-	-	-	-	-	-	-	-
CCMT 120404E-FM:T7335	●	0.4	185	0.15	1.7	140	0.15	1.7	-	-	-	-	-	-	-	-	-	-
CCMT 120404E-FM:T8315	●	0.4	170	0.15	1.7	100	0.14	1.7	160	0.15	1.7	510	0.18	1.7	-	-	-	-
CCMT 120404E-FM:T8415	●	0.4	210	0.15	1.7	110	0.14	1.7	190	0.15	1.7	525	0.18	1.7	-	-	-	-
CCMT 120404E-FM:T8430	●	0.4	195	0.15	1.7	105	0.14	1.7	160	0.15	1.7	540	0.18	1.7	-	-	-	-
CCMT 120404E-FM:T9325	●	0.4	240	0.15	1.7	140	0.15	1.7	225	0.15	1.7	-	-	-	-	-	-	-
CCMT 120404E-FM:T9415	●	0.4	295	0.15	1.7	-	-	-	280	0.15	1.7	-	-	-	-	-	-	-
CCMT 120408E-FM:T7325	●	0.8	205	0.20	1.7	155	0.18	1.7	-	-	-	-	-	-	-	-	-	-
CCMT 120408E-FM:T7335	●	0.8	200	0.20	1.7	155	0.18	1.7	-	-	-	-	-	-	-	-	-	-
CCMT 120408E-FM:T8315	●	0.8	190	0.20	1.7	110	0.18	1.7	180	0.20	1.7	570	0.24	1.7	-	-	-	-
CCMT 120408E-FM:T8415	●	0.8	230	0.20	1.7	120	0.18	1.7	210	0.20	1.7	585	0.24	1.7	-	-	-	-
CCMT 120408E-FM:T8430	⊕	0.8	205	0.20	1.7	110	0.18	1.7	170	0.20	1.7	570	0.24	1.7	-	-	-	-
CCMT 120408E-FM:T9325	●	0.8	250	0.20	1.7	150	0.18	1.7	235	0.20	1.7	-	-	-	-	-	-	-
CCMT 120408E-FM:T9415	●	0.8	315	0.20	1.7	-	-	-	295	0.20	1.7	-	-	-	-	-	-	-
CCMT 120412E-FM:T8430	⊕	1.2	190	0.27	1.7	105	0.24	1.7	155	0.27	1.7	525	0.32	1.7	-	-	-	-
CCMT 120412E-FM:T9325	⊕	1.2	235	0.27	1.7	140	0.24	1.7	220	0.27	1.7	-	-	-	-	-	-	-

Suitability and starting values for cutting speed (vc), feed (f) and depth of cut (ap). Refer to our Machining Calculator app for further calculations.

Product	RE (mm)	P			M			K			N			S			H		
		vc (m/min)	f (mm/rev)	ap (mm)	vc (m/min)	f (mm/rev)	ap (mm)	vc (m/min)	f (mm/rev)	ap (mm)	vc (m/min)	f (mm/rev)	ap (mm)	vc (m/min)	f (mm/rev)	ap (mm)	vc (m/min)	f (mm/rev)	ap (mm)

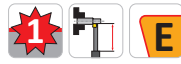
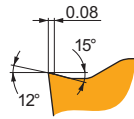

FM chip breaker is versatile and the first choice for finishing of Steels. It features positive rake angle and positive, narrow T-land. It's also suitable for Stainless steels, and conditionally for Cast irons and Non-ferrous alloys.

DCMT 070202E-FM:T7325	● 0.2	✓	175	0.10	0.8	■	135	0.09	0.8	—	—	—	—	—	—	—	—	—
DCMT 070202E-FM:T8315	● 0.2	✓	160	0.10	0.8	■	95	0.09	0.8	✓	150	0.10	0.8	✓	480	0.12	0.8	—
DCMT 070202E-FM:T8415	● 0.2	■	190	0.10	0.8	■	100	0.09	0.8	✓	170	0.10	0.8	✓	480	0.12	0.8	—
DCMT 070202E-FM:T8430	● 0.2	■	185	0.10	0.8	■	100	0.09	0.8	✓	150	0.10	0.8	✓	510	0.12	0.8	—
DCMT 070202E-FM:T9325	● 0.2	■	230	0.10	0.8	■	135	0.09	0.8	✓	215	0.10	0.8	—	—	—	—	—
DCMT 070202E-FM:T9415	● 0.2	■	275	0.10	0.8	—	—	—	—	✓	260	0.10	0.8	—	—	—	—	—
DCMT 070204E-FM:T7325	● 0.4	✓	155	0.17	0.8	■	120	0.15	0.8	—	—	—	—	—	—	—	—	—
DCMT 070204E-FM:T7335	● 0.4	✓	155	0.17	0.8	■	120	0.15	0.8	—	—	—	—	—	—	—	—	—
DCMT 070204E-FM:T8315	● 0.4	✓	160	0.12	0.8	■	95	0.11	0.8	✓	150	0.12	0.8	✓	480	0.14	0.8	—
DCMT 070204E-FM:T8415	● 0.4	■	190	0.12	0.8	■	100	0.11	0.8	✓	170	0.12	0.8	✓	480	0.14	0.8	—
DCMT 070204E-FM:T8430	● 0.4	■	185	0.12	0.8	■	100	0.11	0.8	✓	150	0.12	0.8	✓	510	0.14	0.8	—
DCMT 070204E-FM:T9325	● 0.4	■	190	0.18	0.8	■	110	0.16	0.8	✓	180	0.18	0.8	—	—	—	—	—
DCMT 070204E-FM:T9415	● 0.4	■	275	0.12	0.8	—	—	—	—	✓	260	0.12	0.8	—	—	—	—	—
DCMT 11T302E-FM:T7325	● 0.2	✓	175	0.10	0.8	■	135	0.09	0.8	—	—	—	—	—	—	—	—	—
DCMT 11T302E-FM:T8315	● 0.2	✓	160	0.10	0.8	■	95	0.09	0.8	✓	150	0.10	0.8	✓	480	0.12	0.8	—
DCMT 11T302E-FM:T8415	● 0.2	■	190	0.10	0.8	■	100	0.09	0.8	✓	170	0.10	0.8	✓	480	0.12	0.8	—
DCMT 11T302E-FM:T8430	● 0.2	■	185	0.10	0.8	■	100	0.09	0.8	✓	150	0.10	0.8	✓	510	0.12	0.8	—
DCMT 11T302E-FM:T9325	● 0.2	■	230	0.10	0.8	■	135	0.09	0.8	✓	215	0.10	0.8	—	—	—	—	—
DCMT 11T302E-FM:T9415	● 0.2	■	275	0.10	0.8	—	—	—	—	✓	260	0.10	0.8	—	—	—	—	—
DCMT 11T304E-FM:T7325	● 0.4	✓	155	0.17	0.8	■	120	0.15	0.8	—	—	—	—	—	—	—	—	—
DCMT 11T304E-FM:T7335	● 0.4	✓	155	0.17	0.8	■	120	0.15	0.8	—	—	—	—	—	—	—	—	—
DCMT 11T304E-FM:T8315	● 0.4	✓	160	0.12	0.8	■	95	0.11	0.8	✓	150	0.12	0.8	✓	480	0.14	0.8	—
DCMT 11T304E-FM:T8415	● 0.4	■	190	0.12	0.8	■	100	0.11	0.8	✓	170	0.12	0.8	✓	480	0.14	0.8	—
DCMT 11T304E-FM:T8430	● 0.4	■	155	0.17	0.8	■	85	0.15	0.8	✓	130	0.17	0.8	✓	435	0.20	0.8	—
DCMT 11T304E-FM:T9310	● 0.4	■	285	0.12	0.8	—	—	—	—	✓	270	0.12	0.8	—	—	—	—	—
DCMT 11T304E-FM:T9315	● 0.4	■	255	0.12	0.8	—	—	—	—	✓	240	0.12	0.8	—	—	—	—	—
DCMT 11T304E-FM:T9325	● 0.4	■	190	0.18	0.8	■	110	0.16	0.8	✓	180	0.18	0.8	—	—	—	—	—
DCMT 11T304E-FM:T9415	● 0.4	■	275	0.12	0.8	—	—	—	—	✓	260	0.12	0.8	—	—	—	—	—
DCMT 11T308E-FM:T7325	● 0.8	✓	185	0.17	0.8	■	140	0.15	0.8	—	—	—	—	—	—	—	—	—
DCMT 11T308E-FM:T7335	● 0.8	✓	180	0.17	0.8	■	140	0.15	0.8	—	—	—	—	—	—	—	—	—
DCMT 11T308E-FM:T8315	● 0.8	✓	170	0.17	0.8	■	100	0.15	0.8	✓	160	0.17	0.8	✓	510	0.20	0.8	—
DCMT 11T308E-FM:T8415	● 0.8	■	210	0.17	0.8	■	110	0.15	0.8	✓	190	0.17	0.8	✓	525	0.20	0.8	—
DCMT 11T308E-FM:T8430	● 0.8	■	190	0.17	0.8	■	105	0.15	0.8	✓	155	0.17	0.8	✓	525	0.20	0.8	—
DCMT 11T308E-FM:T9310	● 0.8	■	285	0.17	0.8	—	—	—	—	✓	270	0.17	0.8	—	—	—	—	—
DCMT 11T308E-FM:T9315	● 0.8	■	260	0.17	0.8	—	—	—	—	✓	245	0.17	0.8	—	—	—	—	—
DCMT 11T308E-FM:T9325	● 0.8	■	235	0.17	0.8	■	140	0.15	0.8	✓	220	0.17	0.8	—	—	—	—	—
DCMT 11T308E-FM:T9415	● 0.8	■	290	0.17	0.8	—	—	—	—	✓	275	0.17	0.8	—	—	—	—	—
DCMT 11T312E-FM:T8430	● 1.2	■	175	0.22	1.2	■	95	0.22	1.2	✓	140	0.22	1.2	✓	480	0.26	1.2	—
DCMT 11T312E-FM:T9325	● 1.2	■	210	0.22	1.2	■	125	0.22	1.2	✓	195	0.22	1.2	—	—	—	—	—
DCMT 11T312E-FM:T9415	● 1.2	■	265	0.22	1.2	—	—	—	—	✓	250	0.22	1.2	—	—	—	—	—

Suitability and starting values for cutting speed (vc), feed (f) and depth of cut (ap). Refer to our Machining Calculator app for further calculations.

Product	RE (mm)	P			M			K			N			S			H		
		vc (m/min)	f (mm/rev)	ap (mm)	vc (m/min)	f (mm/rev)	ap (mm)	vc (m/min)	f (mm/rev)	ap (mm)	vc (m/min)	f (mm/rev)	ap (mm)	vc (m/min)	f (mm/rev)	ap (mm)	vc (m/min)	f (mm/rev)	ap (mm)

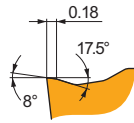

FM chip breaker is versatile and the first choice for finishing of Steels. It features positive rake angle and positive, narrow T-land. It's also suitable for Stainless steels, and conditionally for Cast irons and Non-ferrous alloys.

RCMT 0602M0E-FM:T7325	☹	–	215	0.45	1.2	■	165	0.41	1.2	–	–	–	–	–	–	–	–	–
RCMT 0602M0E-FM:T8430	☹	–	200	0.45	1.2	■	110	0.41	1.2	■	165	0.45	1.2	■	555	0.54	1.2	–
RCMT 0602M0E-FM:T9325	☹	–	235	0.45	1.2	■	140	0.41	1.2	■	220	0.45	1.2	–	–	–	–	–
RCMT 0602M0E-FM:T9415	☹	–	320	0.45	1.2	–	–	–	–	■	300	0.45	1.2	–	–	–	–	–
RCMT 0803M0E-FM:T7325	☹	–	190	0.60	1.6	■	145	0.54	1.6	–	–	–	–	–	–	–	–	–
RCMT 0803M0E-FM:T8430	☹	–	175	0.60	1.6	■	95	0.54	1.6	■	140	0.60	1.6	■	480	0.72	1.6	–
RCMT 0803M0E-FM:T9325	☹	–	200	0.60	1.6	■	120	0.54	1.6	■	190	0.60	1.6	–	–	–	–	–
RCMT 0803M0E-FM:T9415	☹	–	280	0.60	1.6	–	–	–	–	■	265	0.60	1.6	–	–	–	–	–
RCMT 10T3M0E-FM:T7325	☹	–	185	0.65	1.7	■	140	0.59	1.7	–	–	–	–	–	–	–	–	–
RCMT 10T3M0E-FM:T8430	☹	–	170	0.65	1.7	■	90	0.59	1.7	■	135	0.65	1.7	■	465	0.78	1.7	–
RCMT 10T3M0E-FM:T9325	☹	–	195	0.65	1.7	■	115	0.59	1.7	■	185	0.65	1.7	–	–	–	–	–
RCMT 10T3M0E-FM:T9415	☹	–	275	0.65	1.7	–	–	–	–	■	260	0.65	1.7	–	–	–	–	–
RCMT 1204M0E-FM:T7325	☹	–	175	0.70	1.8	■	135	0.63	1.8	–	–	–	–	–	–	–	–	–
RCMT 1204M0E-FM:T8430	☹	–	155	0.70	1.8	■	85	0.63	1.8	■	130	0.70	1.8	■	435	0.84	1.8	–
RCMT 1204M0E-FM:T9325	☹	–	190	0.70	1.8	■	110	0.63	1.8	■	180	0.70	1.8	–	–	–	–	–
RCMT 1204M0E-FM:T9415	☹	–	260	0.70	1.8	–	–	–	–	■	245	0.70	1.8	–	–	–	–	–

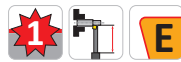
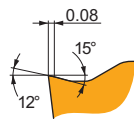
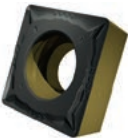

FM chip breaker is versatile and the first choice for finishing of Steels. It features positive rake angle and positive, narrow T-land. It's also suitable for Stainless steels, and conditionally for Cast irons and Non-ferrous alloys.

SCMT 09T304E-FM:T7325	●	0.4	205	0.15	1.2	■	155	0.15	1.2	–	–	–	–	–	–	–	–	–
SCMT 09T304E-FM:T7335	●	0.4	200	0.15	1.2	■	155	0.15	1.2	–	–	–	–	–	–	–	–	–
SCMT 09T304E-FM:T8315	●	0.4	190	0.15	1.2	■	110	0.14	1.2	■	180	0.15	1.2	■	570	0.18	1.2	–
SCMT 09T304E-FM:T8415	●	0.4	230	0.15	1.2	■	120	0.14	1.2	■	210	0.15	1.2	■	585	0.18	1.2	–
SCMT 09T304E-FM:T8430	●	0.4	210	0.15	1.2	■	115	0.14	1.2	■	175	0.15	1.2	■	585	0.18	1.2	–
SCMT 09T304E-FM:T9325	●	0.4	260	0.15	1.2	■	155	0.15	1.2	■	245	0.15	1.2	–	–	–	–	–
SCMT 09T304E-FM:T9415	●	0.4	320	0.15	1.2	–	–	–	–	■	300	0.15	1.2	–	–	–	–	–
SCMT 09T308E-FM:T7325	●	0.8	225	0.20	1.2	■	175	0.18	1.2	–	–	–	–	–	–	–	–	–
SCMT 09T308E-FM:T7335	●	0.8	215	0.20	1.2	■	165	0.18	1.2	–	–	–	–	–	–	–	–	–
SCMT 09T308E-FM:T8315	●	0.8	205	0.20	1.2	■	120	0.18	1.2	■	190	0.20	1.2	■	615	0.24	1.2	–
SCMT 09T308E-FM:T8415	●	0.8	250	0.20	1.2	■	130	0.18	1.2	■	225	0.20	1.2	■	630	0.24	1.2	–
SCMT 09T308E-FM:T8430	☹	0.8	225	0.20	1.2	■	120	0.18	1.2	■	185	0.20	1.2	■	615	0.24	1.2	–
SCMT 09T308E-FM:T9325	●	0.8	275	0.20	1.2	■	165	0.18	1.2	■	260	0.20	1.2	–	–	–	–	–
SCMT 09T308E-FM:T9415	●	0.8	350	0.20	1.2	–	–	–	–	■	330	0.20	1.2	–	–	–	–	–
SCMT 120404E-FM:T7325	●	0.4	195	0.15	1.6	■	150	0.15	1.6	–	–	–	–	–	–	–	–	–
SCMT 120404E-FM:T8315	●	0.4	185	0.15	1.6	■	110	0.14	1.6	■	175	0.15	1.6	■	555	0.18	1.6	–
SCMT 120404E-FM:T8415	●	0.4	225	0.15	1.6	■	115	0.14	1.6	■	205	0.15	1.6	■	570	0.18	1.6	–
SCMT 120404E-FM:T8430	●	0.4	205	0.15	1.6	■	110	0.14	1.6	■	170	0.15	1.6	■	570	0.18	1.6	–
SCMT 120404E-FM:T9325	●	0.4	250	0.15	1.6	■	150	0.15	1.6	■	235	0.15	1.6	–	–	–	–	–
SCMT 120404E-FM:T9415	●	0.4	315	0.15	1.6	–	–	–	–	■	295	0.15	1.6	–	–	–	–	–
SCMT 120408E-FM:T7325	●	0.8	215	0.20	1.6	■	165	0.18	1.6	–	–	–	–	–	–	–	–	–
SCMT 120408E-FM:T7335	●	0.8	210	0.20	1.6	■	160	0.18	1.6	–	–	–	–	–	–	–	–	–
SCMT 120408E-FM:T8315	☹	0.8	200	0.20	1.6	■	120	0.18	1.6	■	190	0.20	1.6	■	600	0.24	1.6	–
SCMT 120408E-FM:T8415	☹	0.8	245	0.20	1.6	■	125	0.18	1.6	■	220	0.20	1.6	■	615	0.24	1.6	–
SCMT 120408E-FM:T8430	☹	0.8	220	0.20	1.6	■	120	0.18	1.6	■	180	0.20	1.6	■	600	0.24	1.6	–
SCMT 120408E-FM:T9325	●	0.8	265	0.20	1.6	■	155	0.18	1.6	■	250	0.20	1.6	–	–	–	–	–
SCMT 120408E-FM:T9415	●	0.8	340	0.20	1.6	–	–	–	–	■	320	0.20	1.6	–	–	–	–	–
SCMT 120412E-FM:T8430	☹	1.2	200	0.27	1.6	■	110	0.24	1.6	■	165	0.27	1.6	■	555	0.32	1.6	–
SCMT 120412E-FM:T9325	☹	1.2	245	0.27	1.6	■	145	0.24	1.6	■	230	0.27	1.6	–	–	–	–	–
SCMT 120412E-FM:T9415	☹	1.2	320	0.27	1.6	–	–	–	–	■	300	0.27	1.6	–	–	–	–	–

Suitability and starting values for cutting speed (vc), feed (f) and depth of cut (ap). Refer to our Machining Calculator app for further calculations.

Product	RE (mm)	P			M			K			N			S			H		
		vc (m/min)	f (mm/rev)	ap (mm)	vc (m/min)	f (mm/rev)	ap (mm)	vc (m/min)	f (mm/rev)	ap (mm)	vc (m/min)	f (mm/rev)	ap (mm)	vc (m/min)	f (mm/rev)	ap (mm)	vc (m/min)	f (mm/rev)	ap (mm)

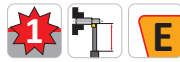
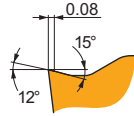

FM chip breaker is versatile and the first choice for finishing of Steels. It features positive rake angle and positive, narrow T-land. It's also suitable for Stainless steels, and conditionally for Cast irons and Non-ferrous alloys.

TCMT 110202E-FM:T7325	●	0.2	185	0.10	0.8	140	0.09	0.8	-	-	-	-	-	-	-	-	-	-
TCMT 110202E-FM:T7335	●	0.2	185	0.10	0.8	140	0.09	0.8	-	-	-	-	-	-	-	-	-	-
TCMT 110202E-FM:T8315	●	0.2	170	0.10	0.8	100	0.09	0.8	160	0.10	0.8	510	0.12	0.8	-	-	-	-
TCMT 110202E-FM:T8415	●	0.2	200	0.10	0.8	105	0.09	0.8	185	0.10	0.8	510	0.12	0.8	-	-	-	-
TCMT 110202E-FM:T8430	●	0.2	195	0.10	0.8	105	0.09	0.8	160	0.10	0.8	540	0.12	0.8	-	-	-	-
TCMT 110202E-FM:T9325	●	0.2	245	0.10	0.8	145	0.09	0.8	230	0.10	0.8	-	-	-	-	-	-	-
TCMT 110202E-FM:T9415	●	0.2	290	0.10	0.8	-	-	-	275	0.10	0.8	-	-	-	-	-	-	-
TCMT 110204E-FM:T7325	●	0.4	160	0.19	0.8	120	0.17	0.8	-	-	-	-	-	-	-	-	-	-
TCMT 110204E-FM:T7335	●	0.4	155	0.19	0.8	120	0.17	0.8	-	-	-	-	-	-	-	-	-	-
TCMT 110204E-FM:T8315	●	0.4	170	0.12	0.8	100	0.11	0.8	160	0.12	0.8	510	0.14	0.8	-	-	-	-
TCMT 110204E-FM:T8415	●	0.4	210	0.12	0.8	110	0.11	0.8	190	0.12	0.8	525	0.14	0.8	-	-	-	-
TCMT 110204E-FM:T8430	●	0.4	195	0.12	0.8	105	0.11	0.8	160	0.12	0.8	540	0.14	0.8	-	-	-	-
TCMT 110204E-FM:T9315	●	0.4	270	0.12	0.8	-	-	-	255	0.12	0.8	-	-	-	-	-	-	-
TCMT 110204E-FM:T9325	●	0.4	205	0.18	0.8	120	0.16	0.8	190	0.18	0.8	-	-	-	-	-	-	-
TCMT 110204E-FM:T9415	●	0.4	295	0.12	0.8	-	-	-	280	0.12	0.8	-	-	-	-	-	-	-
TCMT 110208E-FM:T7325	●	0.8	195	0.17	0.8	150	0.15	0.8	-	-	-	-	-	-	-	-	-	-
TCMT 110208E-FM:T8430	●	0.8	200	0.17	0.8	110	0.15	0.8	165	0.17	0.8	555	0.20	0.8	-	-	-	-
TCMT 110208E-FM:T9325	●	0.8	250	0.17	0.8	150	0.15	0.8	235	0.17	0.8	-	-	-	-	-	-	-
TCMT 110208E-FM:T9415	●	0.8	310	0.17	0.8	-	-	-	290	0.17	0.8	-	-	-	-	-	-	-
TCMT 16T304E-FM:T7325	●	0.4	150	0.19	1.7	115	0.17	1.7	-	-	-	-	-	-	-	-	-	-
TCMT 16T304E-FM:T7335	●	0.4	145	0.19	1.7	110	0.17	1.7	-	-	-	-	-	-	-	-	-	-
TCMT 16T304E-FM:T8315	●	0.4	155	0.12	1.7	90	0.11	1.7	145	0.12	1.7	465	0.14	1.7	-	-	-	-
TCMT 16T304E-FM:T8415	●	0.4	190	0.12	1.7	100	0.11	1.7	170	0.12	1.7	480	0.14	1.7	-	-	-	-
TCMT 16T304E-FM:T8430	●	0.4	180	0.12	1.7	95	0.11	1.7	145	0.12	1.7	495	0.14	1.7	-	-	-	-
TCMT 16T304E-FM:T9325	●	0.4	190	0.18	1.7	110	0.16	1.7	180	0.18	1.7	-	-	-	-	-	-	-
TCMT 16T304E-FM:T9415	●	0.4	270	0.12	1.7	-	-	-	255	0.12	1.7	-	-	-	-	-	-	-
TCMT 16T308E-FM:T7325	●	0.8	180	0.17	1.7	140	0.15	1.7	-	-	-	-	-	-	-	-	-	-
TCMT 16T308E-FM:T7335	●	0.8	175	0.17	1.7	135	0.15	1.7	-	-	-	-	-	-	-	-	-	-
TCMT 16T308E-FM:T8315	●	0.8	170	0.17	1.7	100	0.15	1.7	160	0.17	1.7	510	0.20	1.7	-	-	-	-
TCMT 16T308E-FM:T8415	●	0.8	210	0.17	1.7	110	0.15	1.7	190	0.17	1.7	525	0.20	1.7	-	-	-	-
TCMT 16T308E-FM:T8430	●	0.8	185	0.17	1.7	100	0.15	1.7	150	0.17	1.7	510	0.20	1.7	-	-	-	-
TCMT 16T308E-FM:T9325	●	0.8	230	0.17	1.7	135	0.15	1.7	215	0.17	1.7	-	-	-	-	-	-	-
TCMT 16T308E-FM:T9415	●	0.8	285	0.17	1.7	-	-	-	270	0.17	1.7	-	-	-	-	-	-	-

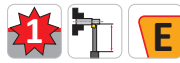
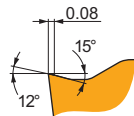

FM chip breaker is versatile and the first choice for finishing of Steels. It features positive rake angle and positive, narrow T-land. It's also suitable for Stainless steels, and conditionally for Cast irons and Non-ferrous alloys.

VBMT 110302E-FM:T7325	●	0.2	160	0.10	0.8	120	0.09	0.8	-	-	-	-	-	-	-	-	-	-
VBMT 110302E-FM:T8315	●	0.2	145	0.10	0.8	85	0.09	0.8	135	0.10	0.8	435	0.12	0.8	-	-	-	-
VBMT 110302E-FM:T8415	●	0.2	180	0.10	0.8	90	0.09	0.8	160	0.10	0.8	450	0.12	0.8	-	-	-	-
VBMT 110302E-FM:T8430	●	0.2	170	0.10	0.8	90	0.09	0.8	135	0.10	0.8	465	0.12	0.8	-	-	-	-
VBMT 110302E-FM:T9325	●	0.2	210	0.10	0.8	125	0.09	0.8	195	0.10	0.8	-	-	-	-	-	-	-
VBMT 110304E-FM:T7325	●	0.4	140	0.19	0.8	105	0.17	0.8	-	-	-	-	-	-	-	-	-	-
VBMT 110304E-FM:T7335	●	0.4	135	0.19	0.8	105	0.17	0.8	-	-	-	-	-	-	-	-	-	-
VBMT 110304E-FM:T8315	●	0.4	145	0.12	0.8	85	0.11	0.8	135	0.12	0.8	435	0.14	0.8	-	-	-	-
VBMT 110304E-FM:T8415	●	0.4	180	0.12	0.8	90	0.11	0.8	160	0.12	0.8	450	0.14	0.8	-	-	-	-
VBMT 110304E-FM:T8430	●	0.4	170	0.12	0.8	90	0.11	0.8	135	0.12	0.8	465	0.14	0.8	-	-	-	-
VBMT 110304E-FM:T9325	●	0.4	175	0.19	0.8	105	0.17	0.8	165	0.19	0.8	-	-	-	-	-	-	-
VBMT 110304E-FM:T9415	●	0.4	255	0.12	0.8	-	-	-	240	0.12	0.8	-	-	-	-	-	-	-
VBMT 110308E-FM:T7325	●	0.8	170	0.17	0.8	130	0.15	0.8	-	-	-	-	-	-	-	-	-	-
VBMT 110308E-FM:T8430	●	0.8	175	0.17	0.8	95	0.15	0.8	140	0.17	0.8	480	0.20	0.8	-	-	-	-
VBMT 110308E-FM:T9315	●	0.8	240	0.17	0.8	-	-	-	225	0.17	0.8	-	-	-	-	-	-	-
VBMT 110308E-FM:T9325	●	0.8	215	0.17	0.8	125	0.15	0.8	200	0.17	0.8	-	-	-	-	-	-	-
VBMT 110308E-FM:T9415	●	0.8	270	0.17	0.8	-	-	-	255	0.17	0.8	-	-	-	-	-	-	-
VBMT 160402E-FM:T7325	●	0.2	150	0.10	1.2	115	0.09	1.2	-	-	-	-	-	-	-	-	-	-
VBMT 160402E-FM:T8430	●	0.2	165	0.10	1.2	90	0.09	1.2	135	0.10	1.2	450	0.12	1.2	-	-	-	-
VBMT 160402E-FM:T9325	●	0.2	205	0.10	1.2	120	0.09	1.2	190	0.10	1.2	-	-	-	-	-	-	-
VBMT 160402E-FM:T9415	●	0.2	245	0.10	1.2	-	-	-	230	0.10	1.2	-	-	-	-	-	-	-

Suitability and starting values for cutting speed (vc), feed (f) and depth of cut (ap). Refer to our Machining Calculator app for further calculations.

Product	RE (mm)	P			M			K			N			S			H		
		vc (m/min)	f (mm/rev)	ap (mm)	vc (m/min)	f (mm/rev)	ap (mm)	vc (m/min)	f (mm/rev)	ap (mm)	vc (m/min)	f (mm/rev)	ap (mm)	vc (m/min)	f (mm/rev)	ap (mm)	vc (m/min)	f (mm/rev)	ap (mm)

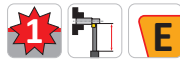
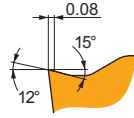

FM chip breaker is versatile and the first choice for finishing of Steels. It features positive rake angle and positive, narrow T-land. It's also suitable for Stainless steels, and conditionally for Cast irons and Non-ferrous alloys.

VBMT 160404E-FM:T5315	●	0.4	225	0.12	1.2	–	–	–	210	0.12	1.2	–	–	–	–	–	–	–	–
VBMT 160404E-FM:T7325	●	0.4	130	0.19	1.2	100	0.17	1.2	–	–	–	–	–	–	–	–	–	–	–
VBMT 160404E-FM:T7335	●	0.4	130	0.19	1.2	100	0.17	1.2	–	–	–	–	–	–	–	–	–	–	–
VBMT 160404E-FM:T8315	●	0.4	140	0.12	1.2	80	0.11	1.2	130	0.12	1.2	420	0.14	1.2	–	–	–	–	–
VBMT 160404E-FM:T8415	●	0.4	170	0.12	1.2	90	0.11	1.2	155	0.12	1.2	435	0.14	1.2	–	–	–	–	–
VBMT 160404E-FM:T8430	●	0.4	165	0.12	1.2	90	0.11	1.2	135	0.12	1.2	450	0.14	1.2	–	–	–	–	–
VBMT 160404E-FM:T9315	●	0.4	225	0.12	1.2	–	–	–	210	0.12	1.2	–	–	–	–	–	–	–	–
VBMT 160404E-FM:T9325	●	0.4	165	0.19	1.2	95	0.17	1.2	155	0.19	1.2	–	–	–	–	–	–	–	–
VBMT 160404E-FM:T9415	●	0.4	245	0.12	1.2	–	–	–	230	0.12	1.2	–	–	–	–	–	–	–	–
VBMT 160408E-FM:T5315	●	0.8	235	0.17	1.2	–	–	–	220	0.17	1.2	–	–	–	–	–	–	–	–
VBMT 160408E-FM:T7325	●	0.8	165	0.17	1.2	125	0.15	1.2	–	–	–	–	–	–	–	–	–	–	–
VBMT 160408E-FM:T7335	●	0.8	160	0.17	1.2	120	0.15	1.2	–	–	–	–	–	–	–	–	–	–	–
VBMT 160408E-FM:T8315	●	0.8	150	0.17	1.2	90	0.15	1.2	140	0.17	1.2	450	0.20	1.2	–	–	–	–	–
VBMT 160408E-FM:T8415	●	0.8	185	0.17	1.2	95	0.15	1.2	165	0.17	1.2	465	0.20	1.2	–	–	–	–	–
VBMT 160408E-FM:T8430	●	0.8	170	0.17	1.2	90	0.15	1.2	135	0.17	1.2	465	0.20	1.2	–	–	–	–	–
VBMT 160408E-FM:T9315	●	0.8	230	0.17	1.2	–	–	–	215	0.17	1.2	–	–	–	–	–	–	–	–
VBMT 160408E-FM:T9325	●	0.8	205	0.17	1.2	120	0.15	1.2	190	0.17	1.2	–	–	–	–	–	–	–	–
VBMT 160408E-FM:T9415	●	0.8	260	0.17	1.2	–	–	–	245	0.17	1.2	–	–	–	–	–	–	–	–
VBMT 160412E-FM:T7325	●	1.2	160	0.22	1.2	120	0.22	1.2	–	–	–	–	–	–	–	–	–	–	–
VBMT 160412E-FM:T8430	●	1.2	155	0.22	1.2	85	0.22	1.2	130	0.22	1.2	435	0.26	1.2	–	–	–	–	–
VBMT 160412E-FM:T9315	●	1.2	215	0.22	1.2	–	–	–	200	0.22	1.2	–	–	–	–	–	–	–	–
VBMT 160412E-FM:T9325	●	1.2	195	0.22	1.2	115	0.22	1.2	185	0.22	1.2	–	–	–	–	–	–	–	–
VBMT 160412E-FM:T9415	●	1.2	245	0.22	1.2	–	–	–	230	0.22	1.2	–	–	–	–	–	–	–	–

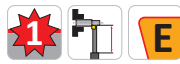
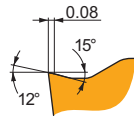

FM chip breaker is versatile and the first choice for finishing of Steels. It features positive rake angle and positive, narrow T-land. It's also suitable for Stainless steels, and conditionally for Cast irons and Non-ferrous alloys.

VCMT 160404E-FM:T7325	●	0.4	125	0.19	1.2	95	0.17	1.2	–	–	–	–	–	–	–	–	–	–	–
VCMT 160404E-FM:T8430	●	0.4	150	0.12	1.2	80	0.11	1.2	125	0.12	1.2	420	0.14	1.2	–	–	–	–	–
VCMT 160404E-FM:T9325	●	0.4	155	0.19	1.2	90	0.17	1.2	145	0.19	1.2	–	–	–	–	–	–	–	–
VCMT 160404E-FM:T9415	●	0.4	230	0.12	1.2	–	–	–	215	0.12	1.2	–	–	–	–	–	–	–	–
VCMT 160408E-FM:T7325	●	0.8	155	0.17	1.2	120	0.15	1.2	–	–	–	–	–	–	–	–	–	–	–
VCMT 160408E-FM:T8430	●	0.8	155	0.17	1.2	85	0.15	1.2	130	0.17	1.2	435	0.20	1.2	–	–	–	–	–
VCMT 160408E-FM:T9325	●	0.8	195	0.17	1.2	115	0.15	1.2	185	0.17	1.2	–	–	–	–	–	–	–	–
VCMT 160408E-FM:T9415	●	0.8	245	0.17	1.2	–	–	–	230	0.17	1.2	–	–	–	–	–	–	–	–

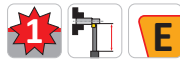
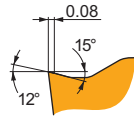
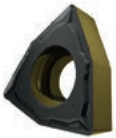

FM chip breaker is versatile and the first choice for finishing of Steels. It features positive rake angle and positive, narrow T-land. It's also suitable for Stainless steels, and conditionally for Cast irons and Non-ferrous alloys.

WCMT 06T304E-FM:T8315	●	0.4	180	0.15	1.2	105	0.14	1.2	170	0.15	1.2	540	0.18	1.2	–	–	–	–	–
WCMT 06T304E-FM:T8415	●	0.4	220	0.15	1.2	115	0.14	1.2	200	0.15	1.2	555	0.18	1.2	–	–	–	–	–
WCMT 06T304E-FM:T8430	●	0.4	200	0.15	1.2	110	0.14	1.2	165	0.15	1.2	555	0.18	1.2	–	–	–	–	–
WCMT 06T304E-FM:T9325	●	0.4	245	0.15	1.2	145	0.15	1.2	230	0.15	1.2	–	–	–	–	–	–	–	–
WCMT 06T304E-FM:T9415	●	0.4	305	0.15	1.2	–	–	–	285	0.15	1.2	–	–	–	–	–	–	–	–
WCMT 06T308E-FM:T7325	●	0.8	215	0.20	1.2	165	0.18	1.2	–	–	–	–	–	–	–	–	–	–	–
WCMT 06T308E-FM:T7335	●	0.8	205	0.20	1.2	155	0.18	1.2	–	–	–	–	–	–	–	–	–	–	–
WCMT 06T308E-FM:T8315	●	0.8	195	0.20	1.2	115	0.18	1.2	185	0.20	1.2	585	0.24	1.2	–	–	–	–	–
WCMT 06T308E-FM:T8415	●	0.8	240	0.20	1.2	125	0.18	1.2	215	0.20	1.2	600	0.24	1.2	–	–	–	–	–
WCMT 06T308E-FM:T8430	●	0.8	210	0.20	1.2	115	0.18	1.2	175	0.20	1.2	585	0.24	1.2	–	–	–	–	–
WCMT 06T308E-FM:T9325	●	0.8	260	0.20	1.2	155	0.18	1.2	245	0.20	1.2	–	–	–	–	–	–	–	–
WCMT 06T308E-FM:T9415	●	0.8	330	0.20	1.2	–	–	–	310	0.20	1.2	–	–	–	–	–	–	–	–
WCMT 080404E-FM:T8430	●	0.4	195	0.15	1.7	105	0.14	1.7	160	0.15	1.7	540	0.18	1.7	–	–	–	–	–
WCMT 080404E-FM:T9325	●	0.4	240	0.15	1.7	140	0.15	1.7	225	0.15	1.7	–	–	–	–	–	–	–	–
WCMT 080408E-FM:T8430	●	0.8	205	0.20	1.7	110	0.18	1.7	170	0.20	1.7	570	0.24	1.7	–	–	–	–	–
WCMT 080408E-FM:T9325	●	0.8	250	0.20	1.7	150	0.18	1.7	235	0.20	1.7	–	–	–	–	–	–	–	–
WCMT 080408E-FM:T9415	●	0.8	315	0.20	1.7	–	–	–	295	0.20	1.7	–	–	–	–	–	–	–	–
WCMT 080412E-FM:T8430	●	1.2	190	0.27	1.7	105	0.24	1.7	155	0.27	1.7	525	0.32	1.7	–	–	–	–	–
WCMT 080412E-FM:T9325	●	1.2	235	0.27	1.7	140	0.24	1.7	220	0.27	1.7	–	–	–	–	–	–	–	–

NF2

NF2 chip breaker is sharp and the first choice for finishing of Stainless steels. It features positive rake angle without T-land. It's also suitable for Super-alloys, and conditionally for Steels, Cast irons and Non-ferrous alloys.

CCMT

	IC (mm)	D1 (mm)	L (mm)	S (mm)
0602	6.350	2.80	6.40	2.38
0803	7.940	3.40	8.10	3.18
09T3	9.525	4.40	9.70	3.97

EPMT

	IC (mm)	D1 (mm)	L (mm)	S (mm)
0502	5.560	2.50	5.70	2.38

VCGT

	IC (mm)	D1 (mm)	L (mm)	S (mm)
1303	7.940	3.40	13.80	3.18

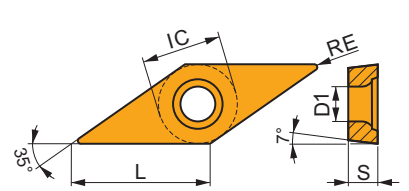
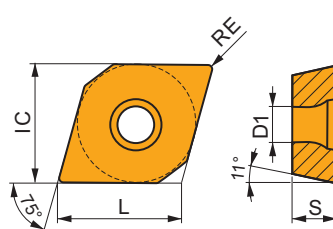
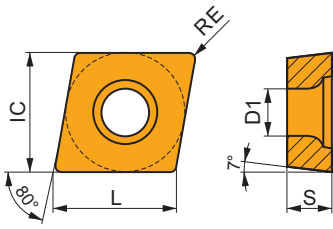

Suitability and starting values for cutting speed (vc), feed (f) and depth of cut (ap). Refer to our Machining Calculator app for further calculations.

Product	RE (mm)	P			M			K			N			S			H		
		vc (m/min)	f (mm/rev)	ap (mm)	vc (m/min)	f (mm/rev)	ap (mm)	vc (m/min)	f (mm/rev)	ap (mm)	vc (m/min)	f (mm/rev)	ap (mm)	vc (m/min)	f (mm/rev)	ap (mm)	vc (m/min)	f (mm/rev)	ap (mm)
	●	170	0.10	0.8	120	0.09	0.8	135	0.10	0.8	510	0.12	0.8	50	0.08	0.6	-	-	-
	●	195	0.10	0.8	150	0.09	0.8	-	-	-	-	-	60	0.08	0.6	-	-	-	
	●	220	0.10	0.8	115	0.09	0.8	200	0.10	0.8	555	0.12	0.8	50	0.08	0.6	-	-	-
	●	210	0.10	0.8	115	0.09	0.8	175	0.10	0.8	585	0.12	0.8	45	0.08	0.6	-	-	-
	●	260	0.10	0.8	155	0.09	0.8	245	0.10	0.8	-	-	-	55	0.08	0.6	-	-	-
	●	170	0.12	0.8	120	0.11	0.8	135	0.12	0.8	510	0.14	0.8	50	0.11	0.6	-	-	-
	●	200	0.12	0.8	155	0.11	0.8	-	-	-	-	-	65	0.11	0.6	-	-	-	
	●	220	0.12	0.8	115	0.11	0.8	200	0.12	0.8	555	0.14	0.8	50	0.11	0.6	-	-	-
	●	205	0.12	0.8	110	0.11	0.8	170	0.12	0.8	570	0.14	0.8	45	0.11	0.6	-	-	-
	●	255	0.12	0.8	150	0.11	0.8	240	0.12	0.8	-	-	-	55	0.11	0.6	-	-	-
	●	220	0.12	0.8	130	0.11	0.8	-	-	-	-	-	45	0.11	0.6	-	-	-	
	●	315	0.12	0.8	-	-	-	295	0.12	0.8	-	-	-	-	-	-	-	-	-
	●	280	0.12	1.0	-	-	-	265	0.12	1.0	-	-	-	-	-	-	-	-	-
	●	190	0.12	1.0	145	0.11	1.0	-	-	-	-	-	60	0.11	0.8	-	-	-	
	●	190	0.12	1.0	145	0.11	1.0	-	-	-	-	-	60	0.11	0.8	-	-	-	
	●	255	0.12	1.0	150	0.11	1.0	240	0.12	1.0	-	-	55	0.11	0.8	-	-	-	
	●	215	0.12	1.2	125	0.11	1.2	-	-	-	-	-	45	0.11	1.0	-	-	-	
	●	305	0.12	1.0	-	-	-	285	0.12	1.0	-	-	-	-	-	-	-	-	-
	●	0.8	-	-	95	0.13	1.2	150	0.14	1.2	485	0.17	1.2	45	0.13	1.0	-	-	-
	●	0.8	295	0.17	1.0	-	-	280	0.17	1.0	-	-	-	-	-	-	-	-	-
	●	0.8	205	0.17	1.0	155	0.15	1.0	-	-	-	-	65	0.14	0.8	-	-	-	
	●	0.8	205	0.17	1.0	155	0.15	1.0	-	-	-	-	65	0.14	0.8	-	-	-	
	●	0.8	260	0.17	1.0	155	0.15	1.0	245	0.17	1.0	-	55	0.14	0.8	-	-	-	
	●	0.4	-	-	85	0.11	1.2	135	0.12	1.2	430	0.14	1.2	40	0.11	1.0	-	-	-
	●	0.4	165	0.12	1.2	115	0.11	1.2	130	0.12	1.2	495	0.14	1.2	45	0.11	1.0	-	-
	●	0.4	190	0.12	1.2	145	0.11	1.2	-	-	-	-	60	0.11	1.0	-	-	-	
	●	0.4	215	0.12	1.2	110	0.11	1.2	195	0.12	1.2	540	0.14	1.2	45	0.11	1.0	-	-
	●	0.4	200	0.12	1.2	110	0.11	1.2	165	0.12	1.2	555	0.14	1.2	40	0.11	1.0	-	-
	●	0.4	250	0.12	1.2	150	0.11	1.2	235	0.12	1.2	-	55	0.11	1.0	-	-	-	
	●	0.4	300	0.12	1.2	-	-	-	285	0.12	1.2	-	-	-	-	-	-	-	-

NF2 chip breaker is sharp and the first choice for finishing of Stainless steels. It features positive rake angle without T-land. It's also suitable for Super-alloys, and conditionally for Steels, Cast irons and Non-ferrous alloys.

Suitability and starting values for cutting speed (vc), feed (f) and depth of cut (ap). Refer to our Machining Calculator app for further calculations.

Product	RE (mm)	P			M			K			N			S			H		
		vc (m/min)	f (mm/rev)	ap (mm)	vc (m/min)	f (mm/rev)	ap (mm)	vc (m/min)	f (mm/rev)	ap (mm)	vc (m/min)	f (mm/rev)	ap (mm)	vc (m/min)	f (mm/rev)	ap (mm)	vc (m/min)	f (mm/rev)	ap (mm)

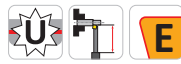
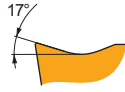
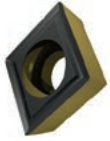

NF2 chip breaker is sharp and the first choice for finishing of Stainless steels. It features positive rake angle without T-land. It's also suitable for Super-alloys, and conditionally for Steels, Cast irons and Non-ferrous alloys.

CCMT 09T308E-NF2:H07	0.8	-	-	-	95	0.13	1.2	150	0.14	1.2	485	0.17	1.2	45	0.13	1.0	-	-	-
CCMT 09T308E-NF2:T6310	0.8	190	0.14	1.2	135	0.13	1.2	150	0.14	1.2	570	0.17	1.2	55	0.13	1.0	-	-	-
CCMT 09T308E-NF2:T7325	0.8	215	0.14	1.2	165	0.13	1.2	-	-	-	-	-	65	0.13	1.0	-	-	-	
CCMT 09T308E-NF2:T8415	0.8	245	0.14	1.2	125	0.13	1.2	220	0.14	1.2	615	0.17	1.2	55	0.13	1.0	-	-	-
CCMT 09T308E-NF2:T8430	0.8	225	0.14	1.2	120	0.13	1.2	185	0.14	1.2	615	0.17	1.2	45	0.13	1.0	-	-	-
CCMT 09T308E-NF2:T9325	0.8	275	0.14	1.2	165	0.13	1.2	260	0.14	1.2	-	-	60	0.13	1.0	-	-	-	
CCMT 09T308E-NF2:T9335	0.8	235	0.14	1.2	140	0.13	1.2	-	-	-	-	-	50	0.13	1.0	-	-	-	
CCMT 09T308E-NF2:T9415	0.8	340	0.14	1.2	-	-	-	320	0.14	1.2	-	-	-	-	-	-	-	-	

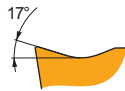
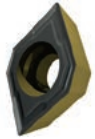

NF2 chip breaker is sharp and the first choice for finishing of Stainless steels. It features positive rake angle without T-land. It's also suitable for Super-alloys, and conditionally for Steels, Cast irons and Non-ferrous alloys.

EPMT 050202E-NF2:H07	0.2	-	-	-	80	0.09	0.8	125	0.10	0.8	405	0.12	0.8	40	0.07	0.6	-	-	-
EPMT 050202E-NF2:T7325	0.2	215	0.07	0.8	165	0.06	0.8	-	-	-	-	-	65	0.06	0.6	-	-	-	
EPMT 050202E-NF2:T7335	0.2	220	0.07	0.8	170	0.06	0.8	-	-	-	-	-	70	0.06	0.6	-	-	-	
EPMT 050202E-NF2:T9325	0.2	305	0.07	0.8	180	0.06	0.8	285	0.07	0.8	-	-	65	0.06	0.6	-	-	-	
EPMT 050202E-NF2:T9335	0.2	200	0.10	0.8	120	0.09	0.8	-	-	-	-	-	45	0.07	0.6	-	-	-	
EPMT 050202E-NF2:T9415	0.2	355	0.05	0.8	-	-	-	335	0.05	0.8	-	-	-	-	-	-	-	-	
EPMT 050202E-NF2:TT010	0.2	345	0.05	0.5	205	0.05	0.5	-	-	-	-	-	-	-	-	-	-	-	

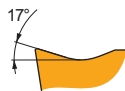

NF2 chip breaker is sharp and the first choice for finishing of Stainless steels. It features positive rake angle without T-land. It's also suitable for Super-alloys, and conditionally for Steels, Cast irons and Non-ferrous alloys.

VCGT 130302E-NF2:H07	0.2	-	-	-	60	0.09	1.0	95	0.10	1.0	310	0.12	1.0	30	0.07	0.8	-	-	-
VCGT 130302E-NF2:T6310	0.2	125	0.07	1.0	90	0.06	1.0	100	0.07	1.0	375	0.08	1.0	35	0.06	0.8	-	-	-
VCGT 130302E-NF2:T7325	0.2	150	0.07	1.0	115	0.06	1.0	-	-	-	-	-	45	0.06	0.8	-	-	-	
VCGT 130302E-NF2:T7335	0.2	150	0.07	1.0	115	0.06	1.0	-	-	-	-	-	45	0.06	0.8	-	-	-	
VCGT 130302E-NF2:T8415	0.2	160	0.07	1.0	85	0.06	1.0	145	0.07	1.0	405	0.08	1.0	35	0.06	0.8	-	-	-
VCGT 130302E-NF2:T9325	0.2	210	0.07	1.0	125	0.06	1.0	195	0.07	1.0	-	-	45	0.06	0.8	-	-	-	
VCGT 130302E-NF2:T9335	0.2	155	0.10	1.0	90	0.09	1.0	-	-	-	-	-	30	0.07	0.8	-	-	-	
VCGT 130302E-NF2:TT010	0.2	240	0.05	0.5	140	0.05	0.5	-	-	-	-	-	-	-	-	-	-	-	
VCGT 130304E-NF2:H07	0.4	-	-	-	60	0.11	1.0	95	0.12	1.0	310	0.14	1.0	30	0.11	0.8	-	-	-
VCGT 130304E-NF2:T5315	0.4	195	0.12	1.0	-	-	-	185	0.12	1.0	-	-	-	-	-	-	-	-	
VCGT 130304E-NF2:T6310	0.4	115	0.12	1.0	80	0.11	1.0	90	0.12	1.0	345	0.14	1.0	30	0.11	0.8	-	-	-
VCGT 130304E-NF2:T7325	0.4	135	0.12	1.0	105	0.11	1.0	-	-	-	-	-	40	0.08	0.8	-	-	-	
VCGT 130304E-NF2:T7335	0.4	135	0.12	1.0	105	0.11	1.0	-	-	-	-	-	40	0.08	0.8	-	-	-	
VCGT 130304E-NF2:T8415	0.4	150	0.12	1.0	75	0.11	1.0	135	0.12	1.0	375	0.14	1.0	30	0.11	0.8	-	-	-
VCGT 130304E-NF2:T9325	0.4	175	0.12	1.0	105	0.11	1.0	165	0.12	1.0	-	-	35	0.08	0.8	-	-	-	
VCGT 130304E-NF2:T9335	0.4	150	0.12	1.0	90	0.11	1.0	-	-	-	-	-	30	0.11	0.8	-	-	-	
VCGT 130304E-NF2:T9415	0.4	225	0.10	1.0	-	-	-	210	0.10	1.0	-	-	-	-	-	-	-	-	
VCGT 130304E-NF2:TT010	0.4	245	0.06	0.5	145	0.06	0.5	-	-	-	-	-	-	-	-	-	-	-	
VCGT 130308E-NF2:T5315	0.8	205	0.17	1.0	-	-	-	190	0.17	1.0	-	-	-	-	-	-	-	-	
VCGT 130308E-NF2:T6310	0.8	125	0.17	1.0	90	0.15	1.0	100	0.17	1.0	375	0.20	1.0	35	0.12	0.8	-	-	-
VCGT 130308E-NF2:T7325	0.8	145	0.17	1.0	110	0.15	1.0	-	-	-	-	-	45	0.12	0.8	-	-	-	
VCGT 130308E-NF2:T7335	0.8	140	0.17	1.0	105	0.15	1.0	-	-	-	-	-	45	0.12	0.8	-	-	-	
VCGT 130308E-NF2:T8415	0.8	160	0.17	1.0	85	0.15	1.0	145	0.17	1.0	405	0.20	1.0	35	0.12	0.8	-	-	-
VCGT 130308E-NF2:T9325	0.8	180	0.17	1.0	105	0.15	1.0	170	0.17	1.0	-	-	40	0.12	0.8	-	-	-	
VCGT 130308E-NF2:T9335	0.8	155	0.18	1.0	90	0.16	1.0	-	-	-	-	-	30	0.16	0.8	-	-	-	
VCGT 130308E-NF2:T9415	0.8	225	0.17	1.0	-	-	-	210	0.17	1.0	-	-	-	-	-	-	-	-	
VCGT 130308E-NF2:TT010	0.8	245	0.10	0.8	145	0.09	0.8	-	-	-	-	-	-	-	-	-	-	-	

UR

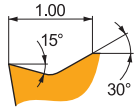

UR chip breaker is versatile and the first choice for finishing of Cast irons. It features positive rake angle without T-land. It's also suitable for Steels, and conditionally for Stainless steels.



CCMT

	IC (mm)	D1 (mm)	L (mm)	S (mm)
0602	6.350	2.80	6.40	2.38
09T3	9.525	4.40	9.70	3.97
1204	12.700	5.50	12.90	4.76

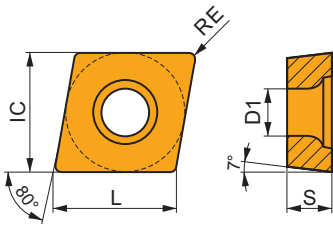

DCMT

	IC (mm)	D1 (mm)	L (mm)	S (mm)
0702	6.350	2.80	7.80	2.38
11T3	9.525	4.40	11.60	3.97

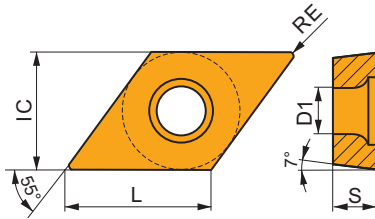

RCMT

	INSD (mm)	D1 (mm)	S (mm)
0602	6.000	2.80	2.38
0803	8.000	3.40	3.18
10T3	10.000	4.40	3.97
1204	12.000	4.40	4.76

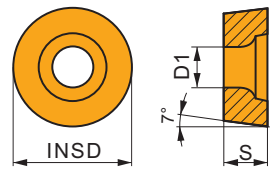

SCMT

	IC (mm)	D1 (mm)	L (mm)	S (mm)
09T3	9.525	4.40	9.53	3.97
1204	12.700	5.50	12.70	4.76

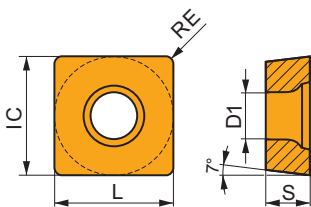

TCMT

	IC (mm)	D1 (mm)	L (mm)	S (mm)
1102	6.350	2.80	11.00	2.38
16T3	9.525	4.40	16.50	3.97

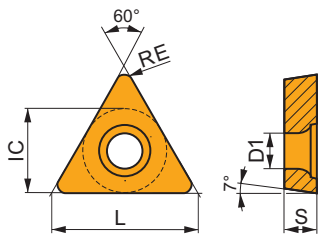

VBMT

	IC (mm)	D1 (mm)	L (mm)	S (mm)
1102	6.350	2.80	11.10	2.38
1604	9.525	4.40	16.60	4.76

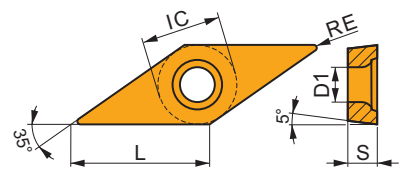

VCMT

	IC (mm)	D1 (mm)	L (mm)	S (mm)
1103	6.350	2.80	11.10	3.18
1604	9.525	4.40	16.60	4.76

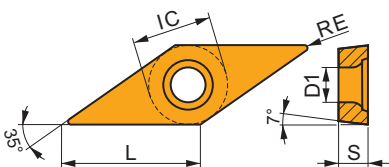

WCMT

	IC (mm)	D1 (mm)	L (mm)	S (mm)
06T3	9.525	4.40	6.50	3.97

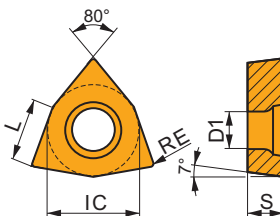

Suitability and starting values for cutting speed (vc), feed (f) and depth of cut (ap). Refer to our Machining Calculator app for further calculations.

Product	RE (mm)	P			M			K			N			S			H		
		vc (m/min)	f (mm/rev)	ap (mm)	vc (m/min)	f (mm/rev)	ap (mm)	vc (m/min)	f (mm/rev)	ap (mm)	vc (m/min)	f (mm/rev)	ap (mm)	vc (m/min)	f (mm/rev)	ap (mm)	vc (m/min)	f (mm/rev)	ap (mm)

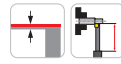
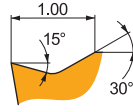
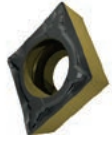

UR chip breaker is versatile and the first choice for finishing of Cast irons. It features positive rake angle without T-land. It's also suitable for Steels, and conditionally for Stainless steels.

CCMT 060202E-UR:T8315	●	0.2	170	0.10	0.8	100	0.09	0.8	160	0.10	0.8	-	-	-	-	-	-	-
CCMT 060202E-UR:T8415	●	0.2	210	0.10	0.8	110	0.09	0.8	190	0.10	0.8	-	-	-	-	-	-	-
CCMT 060202E-UR:T8430	●	0.2	200	0.10	0.8	110	0.09	0.8	165	0.10	0.8	-	-	-	-	-	-	-
CCMT 060202E-UR:T9325	●	0.2	250	0.10	0.8	150	0.09	0.8	235	0.10	0.8	-	-	-	-	-	-	-
CCMT 060202E-UR:T9415	●	0.2	295	0.10	0.8	-	-	-	280	0.10	0.8	-	-	-	-	-	-	-
CCMT 060202E-UR:TT310	●	0.2	275	0.10	0.5	165	0.09	0.5	-	-	-	-	-	-	-	-	-	-
CCMT 060204E-UR:T5315	●	0.4	245	0.15	1.0	-	-	-	230	0.15	1.0	-	-	-	-	-	-	-
CCMT 060204E-UR:T7325	●	0.4	170	0.15	1.0	130	0.15	1.0	-	-	-	-	-	-	-	-	-	-
CCMT 060204E-UR:T7335	●	0.4	170	0.15	1.0	130	0.15	1.0	-	-	-	-	-	-	-	-	-	-
CCMT 060204E-UR:T8315	●	0.4	160	0.15	1.0	95	0.14	1.0	150	0.15	1.0	-	-	-	-	-	-	-
CCMT 060204E-UR:T8415	●	0.4	190	0.15	1.0	100	0.14	1.0	170	0.15	1.0	-	-	-	-	-	-	-
CCMT 060204E-UR:T8430	●	0.4	175	0.15	1.0	95	0.14	1.0	140	0.15	1.0	-	-	-	-	-	-	-
CCMT 060204E-UR:T9325	●	0.4	215	0.15	1.0	125	0.15	1.0	200	0.15	1.0	-	-	-	-	-	-	-
CCMT 060204E-UR:T9415	●	0.4	270	0.15	1.0	-	-	-	255	0.15	1.0	-	-	-	-	-	-	-
CCMT 060204E-UR:TT310	●	0.4	255	0.15	0.5	150	0.14	0.5	-	-	-	-	-	-	-	-	-	-
CCMT 060208E-UR:T5315	●	0.8	270	0.20	1.0	-	-	-	255	0.20	1.0	-	-	-	-	-	-	-
CCMT 060208E-UR:T8430	●	0.8	185	0.20	1.0	100	0.18	1.0	150	0.20	1.0	-	-	-	-	-	-	-
CCMT 060208E-UR:T9325	●	0.8	230	0.20	1.0	135	0.18	1.0	215	0.20	1.0	-	-	-	-	-	-	-
CCMT 060208E-UR:T9415	●	0.8	290	0.20	1.0	-	-	-	275	0.20	1.0	-	-	-	-	-	-	-
CCMT 09T302E-UR:T6310	●	0.2	160	0.10	1.0	115	0.09	1.0	125	0.10	1.0	-	-	-	-	-	-	-
CCMT 09T302E-UR:T8415	●	0.2	200	0.10	1.0	105	0.09	1.0	185	0.10	1.0	-	-	-	-	-	-	-
CCMT 09T302E-UR:T8430	●	0.2	195	0.10	1.0	105	0.09	1.0	160	0.10	1.0	-	-	-	-	-	-	-
CCMT 09T302E-UR:TT310	●	0.2	255	0.10	1.0	150	0.09	1.0	-	-	-	-	-	-	-	-	-	-
CCMT 09T304E-UR:T5315	●	0.4	245	0.15	1.2	-	-	-	230	0.15	1.2	-	-	-	-	-	-	-
CCMT 09T304E-UR:T7325	●	0.4	170	0.15	1.2	130	0.15	1.2	-	-	-	-	-	-	-	-	-	-
CCMT 09T304E-UR:T7335	●	0.4	165	0.15	1.2	125	0.15	1.2	-	-	-	-	-	-	-	-	-	-
CCMT 09T304E-UR:T8315	●	0.4	155	0.15	1.2	90	0.14	1.2	145	0.15	1.2	-	-	-	-	-	-	-
CCMT 09T304E-UR:T8415	●	0.4	190	0.15	1.2	100	0.14	1.2	170	0.15	1.2	-	-	-	-	-	-	-
CCMT 09T304E-UR:T8430	●	0.4	175	0.15	1.2	95	0.14	1.2	140	0.15	1.2	-	-	-	-	-	-	-
CCMT 09T304E-UR:T9315	●	0.4	235	0.15	1.2	-	-	-	220	0.15	1.2	-	-	-	-	-	-	-
CCMT 09T304E-UR:T9325	●	0.4	215	0.15	1.2	125	0.15	1.2	200	0.15	1.2	-	-	-	-	-	-	-
CCMT 09T304E-UR:T9415	●	0.4	265	0.15	1.2	-	-	-	250	0.15	1.2	-	-	-	-	-	-	-
CCMT 09T304E-UR:TT310	●	0.4	235	0.15	1.2	140	0.14	1.2	-	-	-	-	-	-	-	-	-	-
CCMT 09T308E-UR:T5315	●	0.8	265	0.20	1.2	-	-	-	250	0.20	1.2	-	-	-	-	-	-	-
CCMT 09T308E-UR:T7325	●	0.8	185	0.20	1.2	140	0.18	1.2	-	-	-	-	-	-	-	-	-	-
CCMT 09T308E-UR:T7335	●	0.8	175	0.20	1.2	135	0.18	1.2	-	-	-	-	-	-	-	-	-	-
CCMT 09T308E-UR:T8315	●	0.8	170	0.20	1.2	100	0.18	1.2	160	0.20	1.2	-	-	-	-	-	-	-
CCMT 09T308E-UR:T8415	●	0.8	200	0.20	1.2	105	0.18	1.2	185	0.20	1.2	-	-	-	-	-	-	-
CCMT 09T308E-UR:T8430	●	0.8	185	0.20	1.2	100	0.18	1.2	150	0.20	1.2	-	-	-	-	-	-	-
CCMT 09T308E-UR:T9325	●	0.8	225	0.20	1.2	135	0.18	1.2	210	0.20	1.2	-	-	-	-	-	-	-
CCMT 09T308E-UR:T9415	●	0.8	285	0.20	1.2	-	-	-	270	0.20	1.2	-	-	-	-	-	-	-
CCMT 09T308E-UR:TT310	●	0.8	255	0.20	1.2	150	0.18	1.2	-	-	-	-	-	-	-	-	-	-
CCMT 120404E-UR:T5315	●	0.4	235	0.15	1.7	-	-	-	220	0.15	1.7	-	-	-	-	-	-	-
CCMT 120404E-UR:T7325	●	0.4	160	0.15	1.7	120	0.15	1.7	-	-	-	-	-	-	-	-	-	-
CCMT 120404E-UR:T8430	●	0.4	170	0.15	1.7	90	0.14	1.7	135	0.15	1.7	-	-	-	-	-	-	-
CCMT 120404E-UR:T9325	●	0.4	205	0.15	1.7	120	0.15	1.7	190	0.15	1.7	-	-	-	-	-	-	-
CCMT 120404E-UR:T9415	●	0.4	255	0.15	1.7	-	-	-	240	0.15	1.7	-	-	-	-	-	-	-
CCMT 120408E-UR:T5315	●	0.8	255	0.20	1.7	-	-	-	240	0.20	1.7	-	-	-	-	-	-	-
CCMT 120408E-UR:T7325	●	0.8	175	0.20	1.7	135	0.18	1.7	-	-	-	-	-	-	-	-	-	-
CCMT 120408E-UR:T8430	●	0.8	180	0.20	1.7	95	0.18	1.7	145	0.20	1.7	-	-	-	-	-	-	-
CCMT 120408E-UR:T9325	●	0.8	215	0.20	1.7	125	0.18	1.7	200	0.20	1.7	-	-	-	-	-	-	-
CCMT 120408E-UR:T9415	●	0.8	275	0.20	1.7	-	-	-	260	0.20	1.7	-	-	-	-	-	-	-
CCMT 120412E-UR:T5315	●	1.2	240	0.27	1.7	-	-	-	225	0.27	1.7	-	-	-	-	-	-	-
CCMT 120412E-UR:T8430	●	1.2	165	0.27	1.7	90	0.24	1.7	135	0.27	1.7	-	-	-	-	-	-	-
CCMT 120412E-UR:T9325	●	1.2	205	0.27	1.7	120	0.24	1.7	190	0.27	1.7	-	-	-	-	-	-	-
CCMT 120412E-UR:T9415	●	1.2	265	0.27	1.7	-	-	-	250	0.27	1.7	-	-	-	-	-	-	-

Suitability and starting values for cutting speed (vc), feed (f) and depth of cut (ap). Refer to our Machining Calculator app for further calculations.

Product	RE (mm)	P			M			K			N			S			H		
		vc (m/min)	f (mm/rev)	ap (mm)	vc (m/min)	f (mm/rev)	ap (mm)	vc (m/min)	f (mm/rev)	ap (mm)	vc (m/min)	f (mm/rev)	ap (mm)	vc (m/min)	f (mm/rev)	ap (mm)	vc (m/min)	f (mm/rev)	ap (mm)

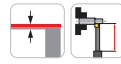
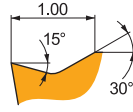

UR chip breaker is versatile and the first choice for finishing of Cast irons. It features positive rake angle without T-land. It's also suitable for Steels, and conditionally for Stainless steels.

DCMT 070202E-UR:T7325	● 0.2	150	0.10	0.8	115	0.09	0.8	—	—	—	—	—	—	—	—	—	—	—
DCMT 070202E-UR:T8315	● 0.2	135	0.10	0.8	80	0.09	0.8	125	0.10	0.8	—	—	—	—	—	—	—	—
DCMT 070202E-UR:T8415	● 0.2	165	0.10	0.8	85	0.09	0.8	150	0.10	0.8	—	—	—	—	—	—	—	—
DCMT 070202E-UR:T8430	● 0.2	155	0.10	0.8	85	0.09	0.8	130	0.10	0.8	—	—	—	—	—	—	—	—
DCMT 070202E-UR:T9325	● 0.2	200	0.10	0.8	120	0.09	0.8	190	0.10	0.8	—	—	—	—	—	—	—	—
DCMT 070202E-UR:T9415	● 0.2	235	0.10	0.8	—	—	—	220	0.10	0.8	—	—	—	—	—	—	—	—
DCMT 070204E-UR:T7325	● 0.4	135	0.17	0.8	105	0.15	0.8	—	—	—	—	—	—	—	—	—	—	—
DCMT 070204E-UR:T8315	● 0.4	135	0.12	0.8	80	0.11	0.8	125	0.12	0.8	—	—	—	—	—	—	—	—
DCMT 070204E-UR:T8415	● 0.4	165	0.12	0.8	85	0.11	0.8	150	0.12	0.8	—	—	—	—	—	—	—	—
DCMT 070204E-UR:T8430	● 0.4	155	0.12	0.8	85	0.11	0.8	130	0.12	0.8	—	—	—	—	—	—	—	—
DCMT 070204E-UR:T9325	● 0.4	165	0.18	0.8	95	0.16	0.8	155	0.18	0.8	—	—	—	—	—	—	—	—
DCMT 070204E-UR:T9415	● 0.4	240	0.12	0.8	—	—	—	225	0.12	0.8	—	—	—	—	—	—	—	—
DCMT 11T302E-UR:T7325	● 0.2	150	0.10	0.8	115	0.09	0.8	—	—	—	—	—	—	—	—	—	—	—
DCMT 11T302E-UR:T8430	● 0.2	155	0.10	0.8	85	0.09	0.8	130	0.10	0.8	—	—	—	—	—	—	—	—
DCMT 11T302E-UR:T9325	● 0.2	200	0.10	0.8	120	0.09	0.8	190	0.10	0.8	—	—	—	—	—	—	—	—
DCMT 11T302E-UR:T9415	● 0.2	235	0.10	0.8	—	—	—	220	0.10	0.8	—	—	—	—	—	—	—	—
DCMT 11T302E-UR:TT310	● 0.2	210	0.10	0.8	125	0.09	0.8	—	—	—	—	—	—	—	—	—	—	—
DCMT 11T304E-UR:T5315	● 0.4	220	0.12	0.8	—	—	—	205	0.12	0.8	—	—	—	—	—	—	—	—
DCMT 11T304E-UR:T7325	● 0.4	135	0.17	0.8	105	0.15	0.8	—	—	—	—	—	—	—	—	—	—	—
DCMT 11T304E-UR:T7335	● 0.4	130	0.17	0.8	100	0.15	0.8	—	—	—	—	—	—	—	—	—	—	—
DCMT 11T304E-UR:T8315	● 0.4	135	0.12	0.8	80	0.11	0.8	125	0.12	0.8	—	—	—	—	—	—	—	—
DCMT 11T304E-UR:T8415	● 0.4	165	0.12	0.8	85	0.11	0.8	150	0.12	0.8	—	—	—	—	—	—	—	—
DCMT 11T304E-UR:T8430	● 0.4	155	0.12	0.8	85	0.11	0.8	130	0.12	0.8	—	—	—	—	—	—	—	—
DCMT 11T304E-UR:T9325	● 0.4	165	0.18	0.8	95	0.16	0.8	155	0.18	0.8	—	—	—	—	—	—	—	—
DCMT 11T304E-UR:T9415	● 0.4	240	0.12	0.8	—	—	—	225	0.12	0.8	—	—	—	—	—	—	—	—
DCMT 11T304E-UR:TT310	● 0.4	210	0.12	0.8	125	0.11	0.8	—	—	—	—	—	—	—	—	—	—	—
DCMT 11T308E-UR:T5315	● 0.8	230	0.17	0.8	—	—	—	215	0.17	0.8	—	—	—	—	—	—	—	—
DCMT 11T308E-UR:T7325	● 0.8	160	0.17	0.8	120	0.15	0.8	—	—	—	—	—	—	—	—	—	—	—
DCMT 11T308E-UR:T7335	● 0.8	155	0.17	0.8	120	0.15	0.8	—	—	—	—	—	—	—	—	—	—	—
DCMT 11T308E-UR:T8315	● 0.8	145	0.17	0.8	85	0.15	0.8	135	0.17	0.8	—	—	—	—	—	—	—	—
DCMT 11T308E-UR:T8415	● 0.8	180	0.17	0.8	90	0.15	0.8	160	0.17	0.8	—	—	—	—	—	—	—	—
DCMT 11T308E-UR:T8430	● 0.8	165	0.17	0.8	90	0.15	0.8	135	0.17	0.8	—	—	—	—	—	—	—	—
DCMT 11T308E-UR:T9325	● 0.8	200	0.17	0.8	120	0.15	0.8	190	0.17	0.8	—	—	—	—	—	—	—	—
DCMT 11T308E-UR:T9415	● 0.8	250	0.17	0.8	—	—	—	235	0.17	0.8	—	—	—	—	—	—	—	—
DCMT 11T308E-UR:TT310	● 0.8	225	0.17	0.8	135	0.15	0.8	—	—	—	—	—	—	—	—	—	—	—
DCMT 11T312E-UR:T9325	● 1.2	180	0.22	1.2	105	0.20	1.2	170	0.22	1.2	—	—	—	—	—	—	—	—
DCMT 11T312E-UR:T9415	● 1.2	230	0.22	1.2	—	—	—	215	0.22	1.2	—	—	—	—	—	—	—	—

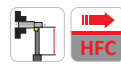
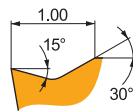
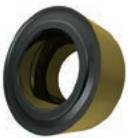

UR chip breaker is versatile and the first choice for finishing of Cast irons. It features positive rake angle without T-land. It's also suitable for Steels, and conditionally for Stainless steels.

RCMT 0602MOE-UR:T6310	● —	170	0.40	1.2	120	0.36	1.2	135	0.40	1.2	—	—	—	—	—	—	—	—
RCMT 0602MOE-UR:T8415	● —	220	0.40	1.2	115	0.36	1.2	200	0.40	1.2	—	—	—	—	—	—	—	—
RCMT 0602MOE-UR:T8430	● —	180	0.40	1.2	95	0.36	1.2	145	0.40	1.2	—	—	—	—	—	—	—	—
RCMT 0602MOE-UR:T9325	● —	215	0.40	1.2	125	0.36	1.2	200	0.40	1.2	—	—	—	—	—	—	—	—
RCMT 0602MOE-UR:T9415	● —	285	0.40	1.2	—	—	—	270	0.40	1.2	—	—	—	—	—	—	—	—
RCMT 0803MOE-UR:T6310	● —	160	0.45	1.6	115	0.41	1.6	125	0.45	1.6	—	—	—	—	—	—	—	—
RCMT 0803MOE-UR:T7325	● —	180	0.45	1.6	140	0.41	1.6	—	—	—	—	—	—	—	—	—	—	—
RCMT 0803MOE-UR:T8415	● —	200	0.45	1.6	105	0.41	1.6	185	0.45	1.6	—	—	—	—	—	—	—	—
RCMT 0803MOE-UR:T8430	● —	170	0.45	1.6	90	0.41	1.6	135	0.45	1.6	—	—	—	—	—	—	—	—
RCMT 0803MOE-UR:T9325	● —	200	0.45	1.6	120	0.41	1.6	190	0.45	1.6	—	—	—	—	—	—	—	—
RCMT 0803MOE-UR:T9415	● —	265	0.45	1.6	—	—	—	250	0.45	1.6	—	—	—	—	—	—	—	—

Suitability and starting values for cutting speed (vc), feed (f) and depth of cut (ap). Refer to our Machining Calculator app for further calculations.

Product	RE (mm)	P			M			K			N			S			H		
		vc (m/min)	f (mm/rev)	ap (mm)	vc (m/min)	f (mm/rev)	ap (mm)	vc (m/min)	f (mm/rev)	ap (mm)	vc (m/min)	f (mm/rev)	ap (mm)	vc (m/min)	f (mm/rev)	ap (mm)	vc (m/min)	f (mm/rev)	ap (mm)

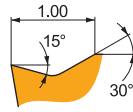
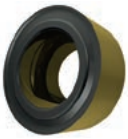

UR chip breaker is versatile and the first choice for finishing of Cast irons. It features positive rake angle without T-land. It's also suitable for Steels, and conditionally for Stainless steels.

RCMT 10T3M0E-UR:T6310	●	—	■	160	0.50	1.4	■	115	0.45	1.4	■	125	0.50	1.4	—	—	—	—	—	—
RCMT 10T3M0E-UR:T7325	●	—	■	175	0.50	1.4	■	135	0.45	1.4	■	—	—	—	—	—	—	—	—	—
RCMT 10T3M0E-UR:T8415	●	—	■	200	0.50	1.4	■	105	0.45	1.4	■	185	0.50	1.4	—	—	—	—	—	—
RCMT 10T3M0E-UR:T8430	●	—	■	165	0.50	1.4	■	90	0.45	1.4	■	135	0.50	1.4	—	—	—	—	—	—
RCMT 10T3M0E-UR:T9325	●	—	■	190	0.50	1.4	■	110	0.45	1.4	■	180	0.50	1.4	—	—	—	—	—	—
RCMT 10T3M0E-UR:T9415	●	—	■	260	0.50	1.4	—	—	—	—	■	245	0.50	1.4	—	—	—	—	—	—
RCMT 1204M0E-UR:T6310	●	—	■	150	0.55	1.8	■	105	0.50	1.8	■	120	0.55	1.8	—	—	—	—	—	—
RCMT 1204M0E-UR:T8415	●	—	■	190	0.55	1.8	■	100	0.49	1.8	■	170	0.55	1.8	—	—	—	—	—	—
RCMT 1204M0E-UR:T8430	●	—	■	145	0.55	1.8	■	80	0.50	1.8	■	120	0.55	1.8	—	—	—	—	—	—
RCMT 1204M0E-UR:T9315	●	—	■	200	0.55	1.8	—	—	—	—	■	190	0.55	1.8	—	—	—	—	—	—
RCMT 1204M0E-UR:T9325	●	—	■	180	0.55	1.8	■	105	0.50	1.8	■	170	0.55	1.8	—	—	—	—	—	—
RCMT 1204M0E-UR:T9415	●	—	■	245	0.55	1.8	—	—	—	—	■	230	0.55	1.8	—	—	—	—	—	—

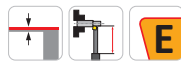
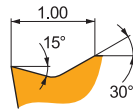
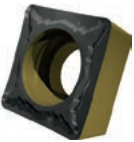

UR chip breaker is versatile and the first choice for finishing of Cast irons. It features positive rake angle without T-land. It's also suitable for Steels, and conditionally for Stainless steels.

SCMT 09T304E-UR:T8430	●	0.4	■	180	0.15	1.2	■	95	0.14	1.2	■	145	0.15	1.2	—	—	—	—	—	—
SCMT 09T304E-UR:T9325	●	0.4	■	225	0.15	1.2	■	135	0.15	1.2	■	210	0.15	1.2	—	—	—	—	—	—
SCMT 09T304E-UR:T9415	●	0.4	■	280	0.15	1.2	—	—	—	—	■	265	0.15	1.2	—	—	—	—	—	—
SCMT 09T308E-UR:T5315	●	0.8	■	280	0.20	1.2	—	—	—	—	■	265	0.20	1.2	—	—	—	—	—	—
SCMT 09T308E-UR:T8430	●	0.8	■	190	0.20	1.2	■	105	0.18	1.2	■	155	0.20	1.2	—	—	—	—	—	—
SCMT 09T308E-UR:T9325	●	0.8	■	235	0.20	1.2	■	140	0.18	1.2	■	220	0.20	1.2	—	—	—	—	—	—
SCMT 09T308E-UR:T9415	●	0.8	■	300	0.20	1.2	—	—	—	—	■	285	0.20	1.2	—	—	—	—	—	—
SCMT 09T308E-UR:TT310	●	0.8	■	270	0.20	1.2	■	160	0.18	1.2	—	—	—	—	—	—	—	—	—	—
SCMT 120408E-UR:T5315	●	0.8	■	270	0.20	1.6	—	—	—	—	■	255	0.20	1.6	—	—	—	—	—	—
SCMT 120408E-UR:T8430	●	0.8	■	185	0.20	1.6	■	100	0.18	1.6	■	150	0.20	1.6	—	—	—	—	—	—
SCMT 120408E-UR:T9325	●	0.8	■	230	0.20	1.6	■	135	0.18	1.6	■	215	0.20	1.6	—	—	—	—	—	—
SCMT 120412E-UR:T8430	●	1.2	■	175	0.27	1.6	■	95	0.24	1.6	■	140	0.27	1.6	—	—	—	—	—	—

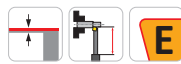
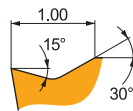

UR chip breaker is versatile and the first choice for finishing of Cast irons. It features positive rake angle without T-land. It's also suitable for Steels, and conditionally for Stainless steels.

TCMT 110204E-UR:T7325	●	0.4	■	135	0.19	0.8	■	105	0.17	0.8	—	—	—	—	—	—	—	—	—	—
TCMT 110204E-UR:T8430	●	0.4	■	170	0.12	0.8	■	90	0.11	0.8	■	135	0.12	0.8	—	—	—	—	—	—
TCMT 110204E-UR:T9325	●	0.4	■	175	0.18	0.8	■	105	0.16	0.8	■	165	0.18	0.8	—	—	—	—	—	—
TCMT 110204E-UR:T9415	●	0.4	■	255	0.12	0.8	—	—	—	—	■	240	0.12	0.8	—	—	—	—	—	—
TCMT 16T304E-UR:T8430	●	0.4	■	170	0.12	0.8	■	90	0.11	0.8	■	135	0.12	0.8	—	—	—	—	—	—
TCMT 16T304E-UR:T9325	●	0.4	■	175	0.18	0.8	■	105	0.16	0.8	■	165	0.18	0.8	—	—	—	—	—	—
TCMT 16T304E-UR:T9415	●	0.4	■	255	0.12	0.8	—	—	—	—	■	240	0.12	0.8	—	—	—	—	—	—
TCMT 16T304E-UR:TT310	●	0.4	■	225	0.12	0.8	■	135	0.11	0.8	—	—	—	—	—	—	—	—	—	—
TCMT 16T308E-UR:T5315	●	0.8	■	245	0.17	0.8	—	—	—	—	■	230	0.17	0.8	—	—	—	—	—	—
TCMT 16T308E-UR:T7325	●	0.8	■	170	0.17	0.8	■	130	0.15	0.8	—	—	—	—	—	—	—	—	—	—
TCMT 16T308E-UR:T8430	●	0.8	■	175	0.17	0.8	■	95	0.15	0.8	■	140	0.17	0.8	—	—	—	—	—	—
TCMT 16T308E-UR:T9325	●	0.8	■	215	0.17	0.8	■	125	0.15	0.8	■	200	0.17	0.8	—	—	—	—	—	—
TCMT 16T308E-UR:T9415	●	0.8	■	265	0.17	0.8	—	—	—	—	■	250	0.17	0.8	—	—	—	—	—	—

Suitability and starting values for cutting speed (vc), feed (f) and depth of cut (ap). Refer to our Machining Calculator app for further calculations.

Product	RE (mm)	P			M			K			N			S			H		
		vc (m/min)	f (mm/rev)	ap (mm)	vc (m/min)	f (mm/rev)	ap (mm)	vc (m/min)	f (mm/rev)	ap (mm)	vc (m/min)	f (mm/rev)	ap (mm)	vc (m/min)	f (mm/rev)	ap (mm)	vc (m/min)	f (mm/rev)	ap (mm)

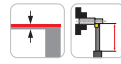
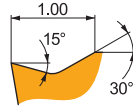

UR chip breaker is versatile and the first choice for finishing of Cast irons. It features positive rake angle without T-land. It's also suitable for Steels, and conditionally for Stainless steels.

VBMT 110202E-UR-TT310	● 0.2	■ 195	0.10	0.8	■ 115	0.09	0.8	■ -	-	-	-	-	-	-	-	-	-	-
VBMT 110204E-UR-T8430	● 0.4	■ 145	0.12	0.8	■ 80	0.11	0.8	■ 120	0.12	0.8	-	-	-	-	-	-	-	-
VBMT 110204E-UR-T9325	● 0.4	■ 150	0.19	0.8	■ 90	0.17	0.8	■ 140	0.19	0.8	-	-	-	-	-	-	-	-
VBMT 160402E-UR-T8430	● 0.2	■ 140	0.10	1.2	■ 75	0.09	1.2	■ 115	0.10	1.2	-	-	-	-	-	-	-	-
VBMT 160404E-UR-T5315	● 0.4	■ 195	0.12	1.2	-	-	-	■ 185	0.12	1.2	-	-	-	-	-	-	-	-
VBMT 160404E-UR-T7325	● 0.4	■ 115	0.19	1.2	■ 85	0.17	1.2	-	-	-	-	-	-	-	-	-	-	-
VBMT 160404E-UR-T8430	● 0.4	■ 140	0.12	1.2	■ 75	0.11	1.2	■ 115	0.12	1.2	-	-	-	-	-	-	-	-
VBMT 160404E-UR-T9325	● 0.4	■ 145	0.18	1.2	■ 85	0.16	1.2	■ 135	0.18	1.2	-	-	-	-	-	-	-	-
VBMT 160404E-UR-T9415	● 0.4	■ 210	0.12	1.2	-	-	-	■ 195	0.12	1.2	-	-	-	-	-	-	-	-
VBMT 160404E-UR-TT310	● 0.4	■ 185	0.12	1.2	■ 110	0.11	1.2	-	-	-	-	-	-	-	-	-	-	-
VBMT 160408E-UR-T5315	● 0.8	■ 205	0.17	1.2	-	-	-	■ 190	0.17	1.2	-	-	-	-	-	-	-	-
VBMT 160408E-UR-T7325	● 0.8	■ 140	0.17	1.2	■ 105	0.15	1.2	-	-	-	-	-	-	-	-	-	-	-
VBMT 160408E-UR-T8430	● 0.8	■ 145	0.17	1.2	■ 80	0.15	1.2	■ 120	0.17	1.2	-	-	-	-	-	-	-	-
VBMT 160408E-UR-T9310	● 0.8	■ 220	0.17	1.2	-	-	-	■ 205	0.17	1.2	-	-	-	-	-	-	-	-
VBMT 160408E-UR-T9325	● 0.8	■ 180	0.17	1.2	■ 105	0.15	1.2	■ 170	0.17	1.2	-	-	-	-	-	-	-	-
VBMT 160408E-UR-T9415	● 0.8	■ 225	0.17	1.2	-	-	-	■ 210	0.17	1.2	-	-	-	-	-	-	-	-
VBMT 160408E-UR-TT310	● 0.8	■ 200	0.17	1.2	■ 120	0.15	1.2	-	-	-	-	-	-	-	-	-	-	-
VBMT 160412E-UR-T8430	● 1.2	■ 135	0.22	1.2	■ 75	0.20	1.2	■ 110	0.22	1.2	-	-	-	-	-	-	-	-
VBMT 160412E-UR-T9325	● 1.2	■ 170	0.22	1.2	■ 100	0.20	1.2	■ 160	0.22	1.2	-	-	-	-	-	-	-	-
VBMT 160412E-UR-T9415	● 1.2	■ 210	0.22	1.2	-	-	-	■ 195	0.22	1.2	-	-	-	-	-	-	-	-

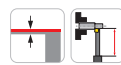
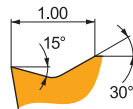

UR chip breaker is versatile and the first choice for finishing of Cast irons. It features positive rake angle without T-land. It's also suitable for Steels, and conditionally for Stainless steels.

VCMT 110304E-UR-T7325	● 0.4	■ 110	0.19	0.8	■ 85	0.17	0.8	■ -	-	-	-	-	-	-	-	-	-	-
VCMT 110304E-UR-T8430	● 0.4	■ 135	0.12	0.8	■ 75	0.11	0.8	■ 110	0.12	0.8	-	-	-	-	-	-	-	-
VCMT 110304E-UR-T9325	● 0.4	■ 140	0.19	0.8	■ 80	0.17	0.8	■ 130	0.19	0.8	-	-	-	-	-	-	-	-
VCMT 110304E-UR-T9415	● 0.4	■ 210	0.12	0.8	-	-	-	■ 195	0.12	0.8	-	-	-	-	-	-	-	-
VCMT 110308E-UR-T7325	● 0.8	■ 140	0.17	0.8	■ 105	0.15	0.8	-	-	-	-	-	-	-	-	-	-	-
VCMT 110308E-UR-T8430	● 0.8	■ 140	0.17	0.8	■ 75	0.15	0.8	■ 115	0.17	0.8	-	-	-	-	-	-	-	-
VCMT 110308E-UR-T9325	● 0.8	■ 175	0.17	0.8	■ 105	0.15	0.8	■ 165	0.17	0.8	-	-	-	-	-	-	-	-
VCMT 110308E-UR-T9415	● 0.8	■ 220	0.17	0.8	-	-	-	■ 205	0.17	0.8	-	-	-	-	-	-	-	-
VCMT 160404E-UR-T7325	● 0.4	■ 110	0.19	1.2	■ 85	0.17	1.2	-	-	-	-	-	-	-	-	-	-	-
VCMT 160404E-UR-T8430	● 0.4	■ 130	0.12	1.2	■ 70	0.11	1.2	■ 105	0.12	1.2	-	-	-	-	-	-	-	-
VCMT 160404E-UR-T9325	● 0.4	■ 135	0.19	1.2	■ 80	0.17	1.2	■ 125	0.19	1.2	-	-	-	-	-	-	-	-
VCMT 160404E-UR-T9415	● 0.4	■ 200	0.12	1.2	-	-	-	■ 190	0.12	1.2	-	-	-	-	-	-	-	-
VCMT 160408E-UR-T7325	● 0.8	■ 135	0.17	1.2	■ 105	0.15	1.2	-	-	-	-	-	-	-	-	-	-	-
VCMT 160408E-UR-T8430	● 0.8	■ 135	0.17	1.2	■ 75	0.15	1.2	■ 110	0.17	1.2	-	-	-	-	-	-	-	-
VCMT 160408E-UR-T9325	● 0.8	■ 170	0.17	1.2	■ 100	0.15	1.2	■ 160	0.17	1.2	-	-	-	-	-	-	-	-
VCMT 160408E-UR-T9415	● 0.8	■ 210	0.17	1.2	-	-	-	■ 195	0.17	1.2	-	-	-	-	-	-	-	-

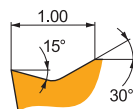

UR chip breaker is versatile and the first choice for finishing of Cast irons. It features positive rake angle without T-land. It's also suitable for Steels, and conditionally for Stainless steels.

WCMT 06T308E-UR-T7325	● 0.8	■ 185	0.20	1.2	■ 140	0.18	1.2	■ -	-	-	-	-	-	-	-	-	-	-
WCMT 06T308E-UR-T9325	● 0.8	■ 225	0.20	1.2	■ 135	0.18	1.2	■ 210	0.20	1.2	-	-	-	-	-	-	-	-

W
-FM

W-FM chip breaker has wiper edge and is designed for finishing of Steels, Stainless steels and Cast irons. It features positive rake angle and positive, narrow T-land.

W
-UR

W-UR chip breaker has wiper edge and is designed for finishing of Steels and Cast irons. It features positive rake angle without T-land. It's also conditionally suitable for Stainless steels.

CCMT

	IC (mm)	D1 (mm)	L (mm)	S (mm)
0602	6.350	2.80	6.40	2.38
09T3	9.525	4.40	9.70	3.97

DCMX

	IC (mm)	D1 (mm)	L (mm)	S (mm)
11T3	9.525	4.40	11.60	3.97

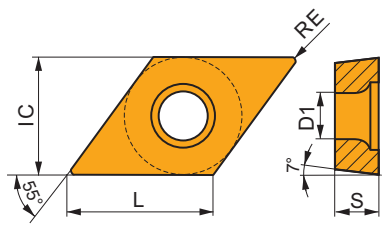
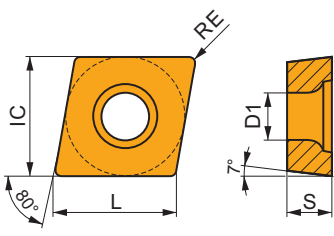

Suitability and starting values for cutting speed (vc), feed (f) and depth of cut (ap). Refer to our Machining Calculator app for further calculations.

Product	RE (mm)	P			M			K			N			S			H		
		vc (m/min)	f (mm/rev)	ap (mm)	vc (m/min)	f (mm/rev)	ap (mm)	vc (m/min)	f (mm/rev)	ap (mm)	vc (m/min)	f (mm/rev)	ap (mm)	vc (m/min)	f (mm/rev)	ap (mm)	vc (m/min)	f (mm/rev)	ap (mm)
	0.4	165	0.30	0.8	90	0.27	0.8	135	0.30	0.8	—	—	—	—	—	—	—	—	—
	0.4	255	0.15	0.5	150	0.14	0.5	—	—	—	—	—	—	—	—	—	—	—	—

W-FM chip breaker has wiper edge and is designed for finishing of Steels, Stainless steels and Cast irons. It features positive rake angle and positive, narrow T-land.

CCMT 060204W-FM:T8430	● 0.4	■ 165	■ 0.30	■ 0.8	■ 90	■ 0.27	■ 0.8	■ 135	■ 0.30	■ 0.8	■ —	■ —	■ —	■ —	■ —	■ —	■ —	■ —	■ —
CCMT 060204W-FM:T9325	● 0.4	■ 190	■ 0.30	■ 0.8	■ 110	■ 0.27	■ 0.8	■ 180	■ 0.30	■ 0.8	■ —	■ —	■ —	■ —	■ —	■ —	■ —	■ —	■ —
CCMT 060204W-FM:T9415	● 0.4	■ 250	■ 0.30	■ 0.8	■ —	■ —	■ —	■ 235	■ 0.30	■ 0.8	■ —	■ —	■ —	■ —	■ —	■ —	■ —	■ —	■ —
CCMT 09T304W-FM:T8430	● 0.4	■ 165	■ 0.30	■ 0.8	■ 90	■ 0.27	■ 0.8	■ 135	■ 0.30	■ 0.8	■ —	■ —	■ —	■ —	■ —	■ —	■ —	■ —	■ —
CCMT 09T304W-FM:T9325	● 0.4	■ 190	■ 0.30	■ 0.8	■ 110	■ 0.27	■ 0.8	■ 180	■ 0.30	■ 0.8	■ —	■ —	■ —	■ —	■ —	■ —	■ —	■ —	■ —
CCMT 09T304W-FM:T9415	● 0.4	■ 305	■ 0.15	■ 1.2	■ —	■ —	■ —	■ 285	■ 0.15	■ 1.2	■ —	■ —	■ —	■ —	■ —	■ —	■ —	■ —	■ —
CCMT 09T308W-FM:T8430	● 0.8	■ 170	■ 0.40	■ 1.0	■ 90	■ 0.36	■ 1.0	■ 135	■ 0.40	■ 1.0	■ —	■ —	■ —	■ —	■ —	■ —	■ —	■ —	■ —
CCMT 09T308W-FM:T9325	● 0.8	■ 200	■ 0.40	■ 1.0	■ 120	■ 0.36	■ 1.0	■ 190	■ 0.40	■ 1.0	■ —	■ —	■ —	■ —	■ —	■ —	■ —	■ —	■ —







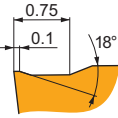

W-UR chip breaker has wiper edge and is designed for finishing of Steels and Cast irons. It features positive rake angle without T-land. It's also conditionally suitable for Stainless steels.

CCMT 060204W-UR:TT310	● 0.4	■ 255	■ 0.15	■ 0.5	■ 150	■ 0.14	■ 0.5	■ —	■ —	■ —	■ —	■ —	■ —	■ —	■ —	■ —	■ —	■ —	■ —
------------------------------	-------	-------	--------	-------	-------	--------	-------	-----	-----	-----	-----	-----	-----	-----	-----	-----	-----	-----	-----

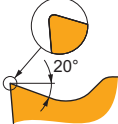
W-FM chip breaker has wiper edge and is designed for finishing of Steels, Stainless steels and Cast irons. It features positive rake angle and positive, narrow T-land.

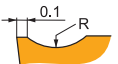
DCMX 11T304W-FM:T7325	● 0.4	■ 130	■ 0.30	■ 0.8	■ 100	■ 0.27	■ 0.8	■ —	■ —	■ —	■ —	■ —	■ —	■ —	■ —	■ —	■ —	■ —	■ —
DCMX 11T304W-FM:T8430	● 0.4	■ 130	■ 0.30	■ 0.8	■ 70	■ 0.27	■ 0.8	■ 105	■ 0.30	■ 0.8	■ —	■ —	■ —	■ —	■ —	■ —	■ —	■ —	■ —
DCMX 11T304W-FM:T9325	● 0.4	■ 155	■ 0.30	■ 0.8	■ 90	■ 0.27	■ 0.8	■ 145	■ 0.30	■ 0.8	■ —	■ —	■ —	■ —	■ —	■ —	■ —	■ —	■ —
DCMX 11T304W-FM:T9415	● 0.4	■ 200	■ 0.30	■ 0.8	■ —	■ —	■ —	■ 190	■ 0.30	■ 0.8	■ —	■ —	■ —	■ —	■ —	■ —	■ —	■ —	■ —
DCMX 11T308W-FM:T8430	● 0.8	■ 130	■ 0.40	■ 1.0	■ 70	■ 0.36	■ 1.0	■ 105	■ 0.40	■ 1.0	■ —	■ —	■ —	■ —	■ —	■ —	■ —	■ —	■ —
DCMX 11T308W-FM:T9325	● 0.8	■ 160	■ 0.40	■ 1.0	■ 95	■ 0.36	■ 1.0	■ 150	■ 0.40	■ 1.0	■ —	■ —	■ —	■ —	■ —	■ —	■ —	■ —	■ —

MEDIUM – NAVIGATOR

<p>FM2</p>			<p>FM2 chip breaker is robust and the first choice for medium machining of Steels. It features positive rake angle and stable, moderate T-land. It's also suitable for Cast irons, and conditionally for Stainless steels.</p>						
<p>SI</p>			<p>SI chip breaker is sharp and the first choice for medium machining of Stainless steels. It features highly positive rake angle without T-land. It's also suitable for Steels and Super-alloys, and conditionally for Cast irons.</p>						
<p>RF</p>	 <table border="1" data-bbox="238 788 354 846"> <thead> <tr> <th>I.C.</th> <th>R</th> </tr> </thead> <tbody> <tr> <td>9.525</td> <td>1.5</td> </tr> <tr> <td>12.7</td> <td>2.5</td> </tr> </tbody> </table>	I.C.	R	9.525	1.5	12.7	2.5		<p>RF chip breaker is robust and the first choice for medium machining of Cast irons. It features slightly positive rake angle and stable, moderate T-land. It's also suitable for Steels, and conditionally for Stainless steels and Hard materials.</p>
I.C.	R								
9.525	1.5								
12.7	2.5								
<p>.CMW</p>			<p>.CMW flat insert is designed for medium machining of Cast irons. It features neutral rake angle without T-land. It's also conditionally suitable for Hard materials.</p>						

FM2

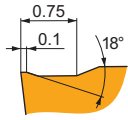

FM2 chip breaker is robust and the first choice for medium machining of Steels. It features positive rake angle and stable, moderate T-land. It's also suitable for Cast irons, and conditionally for Stainless steels.



CCMT

	IC (mm)	D1 (mm)	L (mm)	S (mm)
0803	7.940	3.40	8.10	3.18
09T3	9.525	4.40	9.70	3.97
1204	12.700	5.50	12.90	4.76

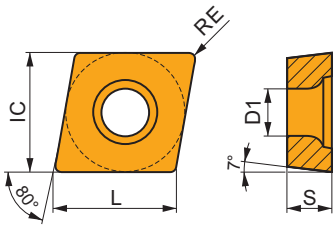

DCMT

	IC (mm)	D1 (mm)	L (mm)	S (mm)
0702	6.350	2.80	7.80	2.38
11T3	9.525	4.40	11.60	3.97
1504	12.700	5.50	15.50	4.76

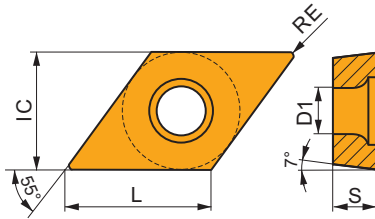

ECMT

	IC (mm)	D1 (mm)	L (mm)	S (mm)
0602	6.350	2.80	6.50	2.38
0803	7.940	3.40	8.20	3.18

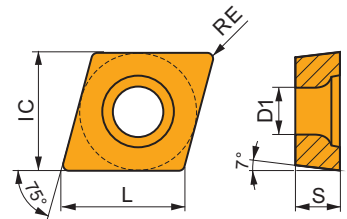

SCMT

	IC (mm)	D1 (mm)	L (mm)	S (mm)
09T3	9.525	4.40	9.53	3.97

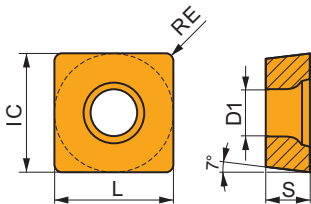

TCMT

	IC (mm)	D1 (mm)	L (mm)	S (mm)
1102	6.350	2.80	11.00	2.38
16T3	9.525	4.40	16.50	3.97

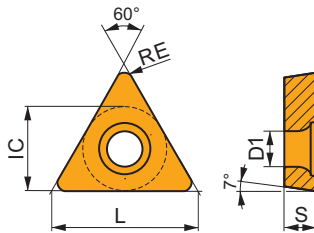

VBMT

	IC (mm)	D1 (mm)	L (mm)	S (mm)
1604	9.525	4.40	16.60	4.76

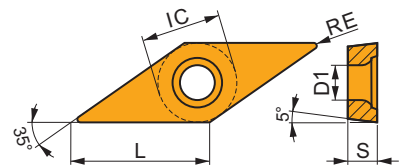

VCGT

	IC (mm)	D1 (mm)	L (mm)	S (mm)
1303	7.940	3.40	13.80	3.18

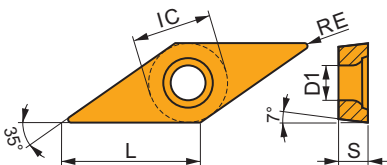

Suitability and starting values for cutting speed (vc), feed (f) and depth of cut (ap). Refer to our Machining Calculator app for further calculations.

Product	RE (mm)	P			M			K			N			S			H		
		vc (m/min)	f (mm/rev)	ap (mm)	vc (m/min)	f (mm/rev)	ap (mm)	vc (m/min)	f (mm/rev)	ap (mm)	vc (m/min)	f (mm/rev)	ap (mm)	vc (m/min)	f (mm/rev)	ap (mm)	vc (m/min)	f (mm/rev)	ap (mm)

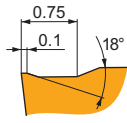
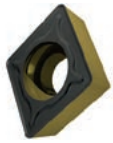

FM2 chip breaker is robust and the first choice for medium machining of Steels. It features positive rake angle and stable, moderate T-land. It's also suitable for Cast irons, and conditionally for Stainless steels.

CCMT 080304E-FM2:T8430	●	0.4	■	205	0.12	1.0	■	110	0.11	1.0	■	170	0.12	1.0	—	—	—	—	—	—
CCMT 080304E-FM2:T9325	●	0.4	■	255	0.12	1.0	■	150	0.11	1.0	■	240	0.12	1.0	—	—	—	—	—	—
CCMT 080304E-FM2:T9335	●	0.4	■	215	0.12	1.0	■	125	0.11	1.0	—	—	—	—	—	—	—	—	—	
CCMT 080304E-FM2:T9415	●	0.4	■	305	0.12	1.0	—	—	—	■	285	0.12	1.0	—	—	—	—	—	—	
CCMT 080308E-FM2:T8430	⊕	0.8	■	210	0.17	1.0	■	115	0.15	1.0	■	175	0.17	1.0	—	—	—	—	—	
CCMT 080308E-FM2:T9325	⊕	0.8	■	260	0.17	1.0	■	155	0.15	1.0	■	245	0.17	1.0	—	—	—	—	—	
CCMT 080308E-FM2:T9335	⊕	0.8	■	225	0.17	1.0	■	135	0.15	1.0	—	—	—	—	—	—	—	—		
CCMT 09T304E-FM2:T6310	●	0.4	■	165	0.12	1.0	■	115	0.11	1.0	■	130	0.12	1.0	—	—	—	—	—	
CCMT 09T304E-FM2:T8430	●	0.4	■	205	0.12	1.0	■	110	0.11	1.0	■	170	0.12	1.0	—	—	—	—	—	
CCMT 09T304E-FM2:T9325	●	0.4	■	255	0.12	1.0	■	150	0.11	1.0	■	240	0.12	1.0	—	—	—	—	—	
CCMT 09T304E-FM2:T9415	●	0.4	■	305	0.12	1.0	—	—	—	■	285	0.12	1.0	—	—	—	—	—		
CCMT 09T308E-FM2:T6310	⊕	0.8	■	180	0.17	1.0	■	125	0.15	1.0	■	145	0.17	1.0	—	—	—	—	—	
CCMT 09T308E-FM2:T7325	⊕	0.8	■	205	0.17	1.0	■	155	0.15	1.0	—	—	—	—	—	—	—	—		
CCMT 09T308E-FM2:T8430	⊕	0.8	■	210	0.17	1.0	■	115	0.15	1.0	■	175	0.17	1.0	—	—	—	—	—	
CCMT 09T308E-FM2:T9325	⊕	0.8	■	260	0.17	1.0	■	155	0.15	1.0	■	245	0.17	1.0	—	—	—	—	—	
CCMT 09T308E-FM2:T9335	⊕	0.8	■	225	0.17	1.0	■	135	0.15	1.0	—	—	—	—	—	—	—	—		
CCMT 09T308E-FM2:T9415	●	0.8	■	320	0.17	1.0	—	—	—	■	300	0.17	1.0	—	—	—	—	—		
CCMT 120408E-FM2:T7325	⊕	0.8	■	190	0.20	1.5	■	145	0.18	1.5	—	—	—	—	—	—	—	—		
CCMT 120408E-FM2:T8430	⊕	0.8	■	190	0.20	1.5	■	105	0.18	1.5	■	155	0.20	1.5	—	—	—	—	—	
CCMT 120408E-FM2:T9325	⊕	0.8	■	235	0.20	1.5	■	140	0.18	1.5	■	220	0.20	1.5	—	—	—	—	—	
CCMT 120408E-FM2:T9335	⊕	0.8	■	200	0.20	1.5	■	120	0.18	1.5	—	—	—	—	—	—	—	—		

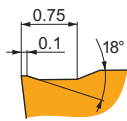
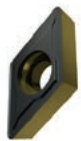

FM2 chip breaker is robust and the first choice for medium machining of Steels. It features positive rake angle and stable, moderate T-land. It's also suitable for Cast irons, and conditionally for Stainless steels.

DCMT 070204E-FM2:T6310	●	0.4	■	135	0.12	0.8	■	95	0.11	0.8	■	105	0.12	0.8	—	—	—	—	—
DCMT 070204E-FM2:T7325	●	0.4	■	160	0.12	0.8	■	120	0.11	0.8	—	—	—	—	—	—	—	—	—
DCMT 070204E-FM2:T8430	●	0.4	■	170	0.12	0.8	■	90	0.11	0.8	■	135	0.12	0.8	—	—	—	—	—
DCMT 070204E-FM2:T9325	●	0.4	■	205	0.12	0.8	■	120	0.11	0.8	■	190	0.12	0.8	—	—	—	—	—
DCMT 070204E-FM2:T9415	●	0.4	■	250	0.12	0.8	—	—	—	■	235	0.12	0.8	—	—	—	—	—	
DCMT 11T304E-FM2:T6310	●	0.4	■	135	0.12	0.8	■	95	0.11	0.8	■	105	0.12	0.8	—	—	—	—	—
DCMT 11T304E-FM2:T7325	●	0.4	■	160	0.12	0.8	■	120	0.11	0.8	—	—	—	—	—	—	—	—	
DCMT 11T304E-FM2:T8430	●	0.4	■	170	0.12	0.8	■	90	0.11	0.8	■	135	0.12	0.8	—	—	—	—	—
DCMT 11T304E-FM2:T9325	●	0.4	■	205	0.12	0.8	■	120	0.11	0.8	■	190	0.12	0.8	—	—	—	—	—
DCMT 11T304E-FM2:T9335	●	0.4	■	175	0.12	0.8	■	105	0.11	0.8	—	—	—	—	—	—	—	—	
DCMT 11T304E-FM2:T9415	●	0.4	■	250	0.12	0.8	—	—	—	■	235	0.12	0.8	—	—	—	—	—	
DCMT 11T308E-FM2:T6310	●	0.8	■	150	0.17	0.8	■	105	0.15	0.8	■	120	0.17	0.8	—	—	—	—	—
DCMT 11T308E-FM2:T7325	●	0.8	■	170	0.17	0.8	■	130	0.15	0.8	—	—	—	—	—	—	—	—	
DCMT 11T308E-FM2:T8430	●	0.8	■	175	0.17	0.8	■	95	0.15	0.8	■	140	0.17	0.8	—	—	—	—	—
DCMT 11T308E-FM2:T9325	●	0.8	■	215	0.17	0.8	■	125	0.15	0.8	■	200	0.17	0.8	—	—	—	—	—
DCMT 11T308E-FM2:T9335	●	0.8	■	180	0.17	0.8	■	105	0.15	0.8	—	—	—	—	—	—	—	—	
DCMT 11T308E-FM2:T9415	●	0.8	■	265	0.17	0.8	—	—	—	■	250	0.17	0.8	—	—	—	—	—	
DCMT 11T312E-FM2:T8430	⊕	1.2	■	155	0.22	1.2	■	85	0.20	1.2	■	130	0.22	1.2	—	—	—	—	—
DCMT 11T312E-FM2:T9325	●	1.2	■	190	0.22	1.2	■	110	0.20	1.2	■	180	0.22	1.2	—	—	—	—	—
DCMT 150408E-FM2:T9325	●	0.8	■	185	0.20	1.5	■	110	0.18	1.5	■	175	0.20	1.5	—	—	—	—	—
DCMT 150408E-FM2:T9335	●	0.8	■	160	0.20	1.5	■	95	0.18	1.5	—	—	—	—	—	—	—	—	

Suitability and starting values for cutting speed (vc), feed (f) and depth of cut (ap). Refer to our Machining Calculator app for further calculations.

Product	RE (mm)	P			M			K			N			S			H		
		vc (m/min)	f (mm/rev)	ap (mm)	vc (m/min)	f (mm/rev)	ap (mm)	vc (m/min)	f (mm/rev)	ap (mm)	vc (m/min)	f (mm/rev)	ap (mm)	vc (m/min)	f (mm/rev)	ap (mm)	vc (m/min)	f (mm/rev)	ap (mm)

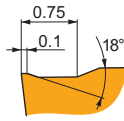
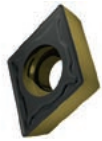

FM2 chip breaker is robust and the first choice for medium machining of Steels. It features positive rake angle and stable, moderate T-land. It's also suitable for Cast irons, and conditionally for Stainless steels.

ECMT 060204E-FM2:T7325	● 0.4	180	0.12	0.8	140	0.11	0.8	—	—	—	—	—	—	—	—	—	—	—
ECMT 060204E-FM2:T8430	● 0.4	205	0.12	0.8	110	0.11	0.8	170	0.12	0.8	—	—	—	—	—	—	—	—
ECMT 060204E-FM2:T9325	● 0.4	255	0.12	0.8	150	0.11	0.8	240	0.12	0.8	—	—	—	—	—	—	—	—
ECMT 060204E-FM2:T9335	● 0.4	220	0.12	0.8	130	0.11	0.8	—	—	—	—	—	—	—	—	—	—	—
ECMT 060204E-FM2:T9415	● 0.4	285	0.12	0.8	—	—	—	270	0.12	0.8	—	—	—	—	—	—	—	—
ECMT 080304E-FM2:T5315	● 0.4	280	0.12	1.0	—	—	—	265	0.12	1.0	—	—	—	—	—	—	—	—
ECMT 080304E-FM2:T7325	● 0.4	170	0.12	1.0	130	0.11	1.0	—	—	—	—	—	—	—	—	—	—	—
ECMT 080304E-FM2:T8430	● 0.4	205	0.12	1.0	110	0.11	1.0	170	0.12	1.0	—	—	—	—	—	—	—	—
ECMT 080304E-FM2:T9325	● 0.4	255	0.12	1.0	150	0.11	1.0	240	0.12	1.0	—	—	—	—	—	—	—	—
ECMT 080304E-FM2:T9335	● 0.4	215	0.12	1.0	125	0.11	1.0	—	—	—	—	—	—	—	—	—	—	—
ECMT 080304E-FM2:T9415	● 0.4	275	0.12	1.0	—	—	—	260	0.12	1.0	—	—	—	—	—	—	—	—
ECMT 080308E-FM2:T7325	● 0.8	185	0.17	1.0	140	0.15	1.0	—	—	—	—	—	—	—	—	—	—	—
ECMT 080308E-FM2:T8430	● 0.8	210	0.17	1.0	115	0.15	1.0	175	0.17	1.0	—	—	—	—	—	—	—	—
ECMT 080308E-FM2:T9325	● 0.8	260	0.17	1.0	155	0.15	1.0	245	0.17	1.0	—	—	—	—	—	—	—	—
ECMT 080308E-FM2:T9335	● 0.8	225	0.17	1.0	135	0.15	1.0	—	—	—	—	—	—	—	—	—	—	—
ECMT 080308E-FM2:T9415	● 0.8	290	0.17	1.0	—	—	—	275	0.17	1.0	—	—	—	—	—	—	—	—

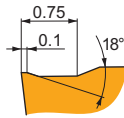
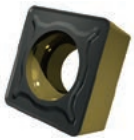

FM2 chip breaker is robust and the first choice for medium machining of Steels. It features positive rake angle and stable, moderate T-land. It's also suitable for Cast irons, and conditionally for Stainless steels.

SCMT 09T304E-FM2:T8430	● 0.4	220	0.12	1.0	120	0.11	1.0	180	0.12	1.0	—	—	—	—	—	—	—	—
SCMT 09T304E-FM2:T9325	● 0.4	265	0.12	1.0	155	0.11	1.0	250	0.12	1.0	—	—	—	—	—	—	—	—
SCMT 09T308E-FM2:T8430	● 0.8	225	0.17	1.0	120	0.15	1.0	185	0.17	1.0	—	—	—	—	—	—	—	—
SCMT 09T308E-FM2:T9325	● 0.8	270	0.17	1.0	160	0.15	1.0	255	0.17	1.0	—	—	—	—	—	—	—	—
SCMT 09T308E-FM2:T9415	● 0.8	340	0.17	1.0	—	—	—	320	0.17	1.0	—	—	—	—	—	—	—	—

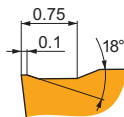
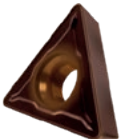

FM2 chip breaker is robust and the first choice for medium machining of Steels. It features positive rake angle and stable, moderate T-land. It's also suitable for Cast irons, and conditionally for Stainless steels.

TCMT 110204E-FM2:T8430	● 0.4	180	0.12	0.8	95	0.11	0.8	145	0.12	0.8	—	—	—	—	—	—	—	—
TCMT 110204E-FM2:T9325	● 0.4	220	0.12	0.8	130	0.11	0.8	205	0.12	0.8	—	—	—	—	—	—	—	—
TCMT 110208E-FM2:T8430	● 0.8	185	0.17	0.8	100	0.15	0.8	150	0.17	0.8	—	—	—	—	—	—	—	—
TCMT 110208E-FM2:T9325	● 0.8	225	0.17	0.8	135	0.15	0.8	210	0.17	0.8	—	—	—	—	—	—	—	—
TCMT 16T308E-FM2:T7325	● 0.8	170	0.20	1.0	130	0.18	1.0	—	—	—	—	—	—	—	—	—	—	—
TCMT 16T308E-FM2:T8430	● 0.8	170	0.20	1.0	90	0.18	1.0	135	0.20	1.0	—	—	—	—	—	—	—	—
TCMT 16T308E-FM2:T9325	● 0.8	205	0.20	1.0	120	0.18	1.0	190	0.20	1.0	—	—	—	—	—	—	—	—
TCMT 16T308E-FM2:T9335	● 0.8	175	0.20	1.0	105	0.18	1.0	—	—	—	—	—	—	—	—	—	—	—

Suitability and starting values for cutting speed (vc), feed (f) and depth of cut (ap). Refer to our Machining Calculator app for further calculations.

Product	RE (mm)	P			M			K			N			S			H		
		vc (m/min)	f (mm/rev)	ap (mm)	vc (m/min)	f (mm/rev)	ap (mm)	vc (m/min)	f (mm/rev)	ap (mm)	vc (m/min)	f (mm/rev)	ap (mm)	vc (m/min)	f (mm/rev)	ap (mm)	vc (m/min)	f (mm/rev)	ap (mm)

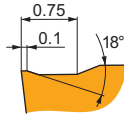

FM2 chip breaker is robust and the first choice for medium machining of Steels. It features positive rake angle and stable, moderate T-land. It's also suitable for Cast irons, and conditionally for Stainless steels.

VBMT 160404E-FM2:T6310	●	0.4	120	0.12	1.2	85	0.11	1.2	95	0.12	1.2	-	-	-	-	-	-	-
VBMT 160404E-FM2:T7325	●	0.4	140	0.12	1.2	105	0.11	1.2	-	-	-	-	-	-	-	-	-	-
VBMT 160404E-FM2:T8430	●	0.4	145	0.12	1.2	80	0.11	1.2	120	0.12	1.2	-	-	-	-	-	-	-
VBMT 160404E-FM2:T9325	●	0.4	185	0.12	1.2	110	0.11	1.2	175	0.12	1.2	-	-	-	-	-	-	-
VBMT 160404E-FM2:T9335	●	0.4	155	0.12	1.2	90	0.11	1.2	-	-	-	-	-	-	-	-	-	-
VBMT 160404E-FM2:T9415	●	0.4	220	0.12	1.2	-	-	-	205	0.12	1.2	-	-	-	-	-	-	-
VBMT 160408E-FM2:T6310	●	0.8	125	0.20	1.2	90	0.18	1.2	100	0.20	1.2	-	-	-	-	-	-	-
VBMT 160408E-FM2:T7325	●	0.8	145	0.20	1.2	110	0.18	1.2	-	-	-	-	-	-	-	-	-	-
VBMT 160408E-FM2:T8430	●	0.8	140	0.20	1.2	75	0.18	1.2	115	0.20	1.2	-	-	-	-	-	-	-
VBMT 160408E-FM2:T9325	●	0.8	175	0.20	1.2	105	0.18	1.2	165	0.20	1.2	-	-	-	-	-	-	-
VBMT 160408E-FM2:T9335	●	0.8	150	0.20	1.2	90	0.18	1.2	-	-	-	-	-	-	-	-	-	-
VBMT 160408E-FM2:T9415	●	0.8	220	0.20	1.2	-	-	-	205	0.20	1.2	-	-	-	-	-	-	-
VBMT 160412E-FM2:T8430	●	1.2	145	0.22	1.2	80	0.20	1.2	120	0.22	1.2	-	-	-	-	-	-	-
VBMT 160412E-FM2:T9315	●	1.2	195	0.22	1.2	-	-	-	185	0.22	1.2	-	-	-	-	-	-	-
VBMT 160412E-FM2:T9325	●	1.2	175	0.22	1.2	105	0.20	1.2	165	0.22	1.2	-	-	-	-	-	-	-
VBMT 160412E-FM2:T9415	●	1.2	225	0.22	1.2	-	-	-	210	0.22	1.2	-	-	-	-	-	-	-

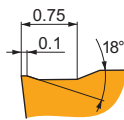

FM2 chip breaker is robust and the first choice for medium machining of Steels. It features positive rake angle and stable, moderate T-land. It's also suitable for Cast irons, and conditionally for Stainless steels.

VCGT 130308E-FM2:T8430	●	0.8	145	0.17	1.0	80	0.15	1.0	120	0.17	1.0	-	-	-	-	-	-	-
VCGT 130308E-FM2:T9325	●	0.8	180	0.17	1.0	105	0.15	1.0	170	0.17	1.0	-	-	-	-	-	-	-

SI

SI chip breaker is sharp and the first choice for medium machining of Stainless steels. It features highly positive rake angle without T-land. It's also suitable for Steels and Super-alloys, and conditionally for Cast irons.

PRAMET

CCGT

	IC (mm)	D1 (mm)	L (mm)	S (mm)
0602	6.350	2.80	6.40	2.38
09T3	9.525	4.40	9.70	3.97
1204	12.700	5.50	12.90	4.76

DCGT

	IC (mm)	D1 (mm)	L (mm)	S (mm)
11T3	9.525	4.40	11.60	3.97

TCGT

	IC (mm)	D1 (mm)	L (mm)	S (mm)
1102	6.350	2.80	11.00	2.38

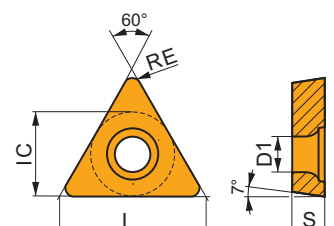
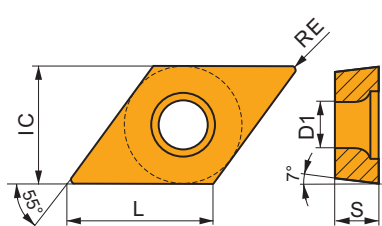
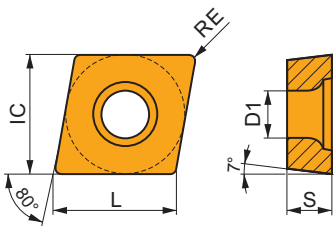

Suitability and starting values for cutting speed (vc), feed (f) and depth of cut (ap). Refer to our Machining Calculator app for further calculations.

Product	RE (mm)	P			M			K			N			S			H		
		vc	f	ap	vc	f	ap	vc	f	ap	vc	f	ap	vc	f	ap	vc	f	ap
		(m/min)	(mm/rev)	(mm)	(m/min)	(mm/rev)	(mm)	(m/min)	(mm/rev)	(mm)	(m/min)	(mm/rev)	(mm)	(m/min)	(mm/rev)	(mm)	(m/min)	(mm/rev)	(mm)

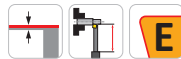
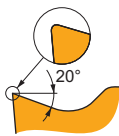
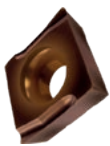

SI chip breaker is sharp and the first choice for medium machining of Stainless steels. It features highly positive rake angle without T-land. It's also suitable for Steels and Super-alloys, and conditionally for Cast irons.

CCGT 060202ER-SI:T8430	● 0.2	■ 260	■ 0.10	■ 0.8	■ 140	■ 0.09	■ 0.8	■ 215	■ 0.10	■ 0.8	■ -	■ -	■ -	■ 55	■ 0.08	■ 0.6	■ -	■ -	■ -
CCGT 060204ER-SI:T8315	● 0.4	■ 225	■ 0.12	■ 0.8	■ 135	■ 0.11	■ 0.8	■ 210	■ 0.12	■ 0.8	■ -	■ -	■ -	■ 55	■ 0.10	■ 0.6	■ -	■ -	■ -
CCGT 060204ER-SI:T8430	● 0.4	■ 260	■ 0.12	■ 0.8	■ 140	■ 0.11	■ 0.8	■ 215	■ 0.12	■ 0.8	■ -	■ -	■ -	■ 55	■ 0.10	■ 0.6	■ -	■ -	■ -
CCGT 09T304ER-SI:T8315	● 0.4	■ 205	■ 0.17	■ 0.8	■ 120	■ 0.15	■ 0.8	■ 190	■ 0.17	■ 0.8	■ -	■ -	■ -	■ 50	■ 0.15	■ 0.6	■ -	■ -	■ -
CCGT 09T304ER-SI:T8430	● 0.4	■ 230	■ 0.17	■ 0.8	■ 125	■ 0.15	■ 0.8	■ 185	■ 0.17	■ 0.8	■ -	■ -	■ -	■ 45	■ 0.15	■ 0.6	■ -	■ -	■ -
CCGT 120408ER-SI:T8430	● 0.8	■ 230	■ 0.24	■ 1.0	■ 125	■ 0.22	■ 1.0	■ 185	■ 0.24	■ 1.0	■ -	■ -	■ -	■ 45	■ 0.22	■ 0.8	■ -	■ -	■ -

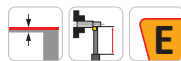
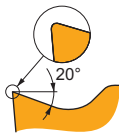
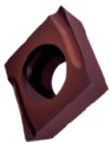

SI chip breaker is sharp and the first choice for medium machining of Stainless steels. It features highly positive rake angle without T-land. It's also suitable for Steels and Super-alloys, and conditionally for Cast irons.

CCGT 060202EL-SI:T8430	● 0.2	■ 260	■ 0.10	■ 0.8	■ 140	■ 0.09	■ 0.8	■ 215	■ 0.10	■ 0.8	■ -	■ -	■ -	■ 55	■ 0.08	■ 0.6	■ -	■ -	■ -
CCGT 060204EL-SI:T8315	● 0.4	■ 225	■ 0.12	■ 0.8	■ 135	■ 0.11	■ 0.8	■ 210	■ 0.12	■ 0.8	■ -	■ -	■ -	■ 55	■ 0.10	■ 0.6	■ -	■ -	■ -
CCGT 060204EL-SI:T8415	● 0.4	■ 275	■ 0.12	■ 0.8	■ 140	■ 0.11	■ 0.8	■ 250	■ 0.12	■ 0.8	■ -	■ -	■ -	■ 60	■ 0.10	■ 0.6	■ -	■ -	■ -
CCGT 060204EL-SI:T8430	● 0.4	■ 260	■ 0.12	■ 0.8	■ 140	■ 0.11	■ 0.8	■ 215	■ 0.12	■ 0.8	■ -	■ -	■ -	■ 55	■ 0.10	■ 0.6	■ -	■ -	■ -
CCGT 09T304EL-SI:T8315	● 0.4	■ 205	■ 0.17	■ 0.8	■ 120	■ 0.15	■ 0.8	■ 190	■ 0.17	■ 0.8	■ -	■ -	■ -	■ 50	■ 0.15	■ 0.6	■ -	■ -	■ -
CCGT 09T304EL-SI:T8415	● 0.4	■ 250	■ 0.17	■ 0.8	■ 130	■ 0.15	■ 0.8	■ 225	■ 0.17	■ 0.8	■ -	■ -	■ -	■ 55	■ 0.15	■ 0.6	■ -	■ -	■ -
CCGT 09T304EL-SI:T8430	● 0.4	■ 230	■ 0.17	■ 0.8	■ 125	■ 0.15	■ 0.8	■ 185	■ 0.17	■ 0.8	■ -	■ -	■ -	■ 45	■ 0.15	■ 0.6	■ -	■ -	■ -
CCGT 120408EL-SI:T8430	● 0.8	■ 230	■ 0.24	■ 1.0	■ 125	■ 0.22	■ 1.0	■ 185	■ 0.24	■ 1.0	■ -	■ -	■ -	■ 45	■ 0.22	■ 0.8	■ -	■ -	■ -

Suitability and starting values for cutting speed (vc), feed (f) and depth of cut (ap). Refer to our Machining Calculator app for further calculations.

Product	RE (mm)	P			M			K			N			S			H		
		vc (m/min)	f (mm/rev)	ap (mm)	vc (m/min)	f (mm/rev)	ap (mm)	vc (m/min)	f (mm/rev)	ap (mm)	vc (m/min)	f (mm/rev)	ap (mm)	vc (m/min)	f (mm/rev)	ap (mm)	vc (m/min)	f (mm/rev)	ap (mm)

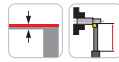
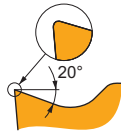
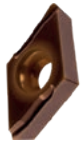

SI chip breaker is sharp and the first choice for medium machining of Stainless steels. It features highly positive rake angle without T-land. It's also suitable for Steels and Super-alloys, and conditionally for Cast irons.

DCGT 11T304ER-SI-T8430	● 0.4	■ 205	■ 0.12	■ 0.8	■ 110	■ 0.11	■ 0.8	■ 170	■ 0.12	■ 0.8	■ -	■ -	■ -	■ 45	■ 0.10	■ 0.6	■ -	■ -	■ -
DCGT 11T308ER-SI-T8430	● 0.8	■ 190	■ 0.22	■ 1.0	■ 105	■ 0.20	■ 1.0	■ 155	■ 0.22	■ 1.0	■ -	■ -	■ -	■ 40	■ 0.18	■ 0.8	■ -	■ -	■ -

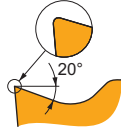

SI chip breaker is sharp and the first choice for medium machining of Stainless steels. It features highly positive rake angle without T-land. It's also suitable for Steels and Super-alloys, and conditionally for Cast irons.

DCGT 11T304EL-SI-T8430	● 0.4	■ 205	■ 0.12	■ 0.8	■ 110	■ 0.11	■ 0.8	■ 170	■ 0.12	■ 0.8	■ -	■ -	■ -	■ 45	■ 0.10	■ 0.6	■ -	■ -	■ -
DCGT 11T308EL-SI-T8430	● 0.8	■ 190	■ 0.22	■ 1.0	■ 105	■ 0.20	■ 1.0	■ 155	■ 0.22	■ 1.0	■ -	■ -	■ -	■ 40	■ 0.18	■ 0.8	■ -	■ -	■ -

Suitability and starting values for cutting speed (vc), feed (f) and depth of cut (ap). Refer to our Machining Calculator app for further calculations.

Product	RE (mm)	Interrupted/ Continuous cut	P			M			K			N			S			H		
			vc (m/min)	f (mm/rev)	ap (mm)	vc (m/min)	f (mm/rev)	ap (mm)	vc (m/min)	f (mm/rev)	ap (mm)	vc (m/min)	f (mm/rev)	ap (mm)	vc (m/min)	f (mm/rev)	ap (mm)	vc (m/min)	f (mm/rev)	ap (mm)

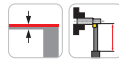
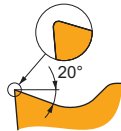
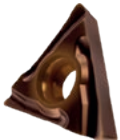

SI chip breaker is sharp and the first choice for medium machining of Stainless steels. It features highly positive rake angle without T-land. It's also suitable for Steels and Super-alloys, and conditionally for Cast irons.

TCGT 110202ER-SI-T8315	● 0.2	■ 190	■ 0.10	■ 0.8	■ 110	■ 0.09	■ 0.8	■ 180	■ 0.10	■ 0.8	■ -	■ -	■ -	■ 45	■ 0.08	■ 0.6	■ -	■ -	■ -
TCGT 110202ER-SI-T8430	● 0.2	■ 225	■ 0.10	■ 0.8	■ 120	■ 0.09	■ 0.8	■ 185	■ 0.10	■ 0.8	■ -	■ -	■ -	■ 45	■ 0.08	■ 0.6	■ -	■ -	■ -
TCGT 110204ER-SI-T8430	● 0.4	■ 225	■ 0.12	■ 0.8	■ 120	■ 0.11	■ 0.8	■ 185	■ 0.12	■ 0.8	■ -	■ -	■ -	■ 45	■ 0.10	■ 0.6	■ -	■ -	■ -

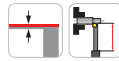
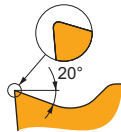
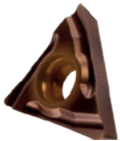

SI chip breaker is sharp and the first choice for medium machining of Stainless steels. It features highly positive rake angle without T-land. It's also suitable for Steels and Super-alloys, and conditionally for Cast irons.

TCGT 110202EL-SI-T8315	● 0.2	■ 190	■ 0.10	■ 0.8	■ 110	■ 0.09	■ 0.8	■ 180	■ 0.10	■ 0.8	■ -	■ -	■ -	■ 45	■ 0.08	■ 0.6	■ -	■ -	■ -
TCGT 110202EL-SI-T8415	● 0.2	■ 230	■ 0.10	■ 0.8	■ 120	■ 0.09	■ 0.8	■ 210	■ 0.10	■ 0.8	■ -	■ -	■ -	■ 50	■ 0.08	■ 0.6	■ -	■ -	■ -
TCGT 110202EL-SI-T8430	● 0.2	■ 225	■ 0.10	■ 0.8	■ 120	■ 0.09	■ 0.8	■ 185	■ 0.10	■ 0.8	■ -	■ -	■ -	■ 45	■ 0.08	■ 0.6	■ -	■ -	■ -
TCGT 110204EL-SI-T8315	● 0.4	■ 195	■ 0.12	■ 0.8	■ 115	■ 0.11	■ 0.8	■ 185	■ 0.12	■ 0.8	■ -	■ -	■ -	■ 45	■ 0.10	■ 0.6	■ -	■ -	■ -
TCGT 110204EL-SI-T8415	● 0.4	■ 230	■ 0.12	■ 0.8	■ 120	■ 0.11	■ 0.8	■ 210	■ 0.12	■ 0.8	■ -	■ -	■ -	■ 50	■ 0.10	■ 0.6	■ -	■ -	■ -
TCGT 110204EL-SI-T8430	● 0.4	■ 225	■ 0.12	■ 0.8	■ 120	■ 0.11	■ 0.8	■ 185	■ 0.12	■ 0.8	■ -	■ -	■ -	■ 45	■ 0.10	■ 0.6	■ -	■ -	■ -

RF

IC	R
9.525	1.5
12.7	2.5

RF chip breaker is robust and the first choice for medium machining of Cast irons. It features slightly positive rake angle and stable, moderate T-land. It's also suitable for Steels, and conditionally for Stainless steels and Hard materials.

CCMT

	IC	D1	L	S
	(mm)	(mm)	(mm)	(mm)
0602	6.350	2.80	6.40	2.38
09T3	9.525	4.40	9.70	3.97
1204	12.700	5.50	12.90	4.76

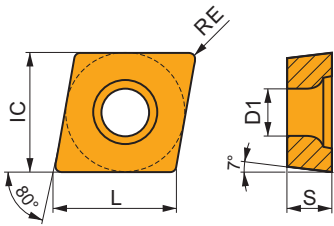

DCMT

	IC	D1	L	S
	(mm)	(mm)	(mm)	(mm)
11T3	9.525	4.40	11.60	3.97

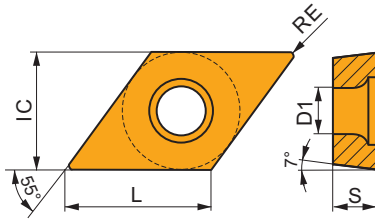

SCMT

	IC	D1	L	S
	(mm)	(mm)	(mm)	(mm)
09T3	9.525	4.40	9.53	3.97
1204	12.700	5.50	12.70	4.76

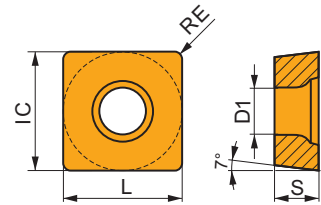

TCMT

	IC	D1	L	S
	(mm)	(mm)	(mm)	(mm)
16T3	9.525	4.40	16.50	3.97

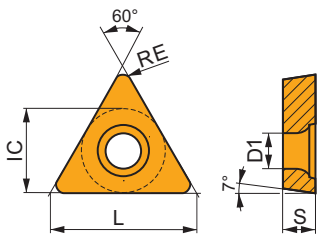

WCMT

	IC	D1	L	S
	(mm)	(mm)	(mm)	(mm)
06T3	9.525	4.40	6.50	3.97
0804	12.700	5.50	8.70	4.76

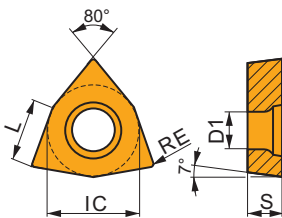

Suitability and starting values for cutting speed (vc), feed (f) and depth of cut (ap). Refer to our Machining Calculator app for further calculations.

Product	RE (mm)	P			M			K			N			S			H		
		vc (m/min)	f (mm/rev)	ap (mm)	vc (m/min)	f (mm/rev)	ap (mm)	vc (m/min)	f (mm/rev)	ap (mm)	vc (m/min)	f (mm/rev)	ap (mm)	vc (m/min)	f (mm/rev)	ap (mm)	vc (m/min)	f (mm/rev)	ap (mm)

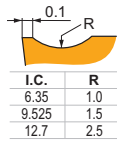

RF chip breaker is robust and the first choice for medium machining of Cast irons. It features slightly positive rake angle and stable, moderate T-land. It's also suitable for Steels, and conditionally for Stainless steels and Hard materials.

CCMT 060202E-RF-T7335	● 0.2	✔ 150	0.15	1.0	✔ 115	0.14	1.0	–	–	–	–	–	–	–	–	–	–	–	
CCMT 060204E-RF-T5315	● 0.4	✔ 235	0.15	1.0	–	–	–	✔ 220	0.15	1.0	–	–	–	–	–	–	✔ 45	0.11	0.3
CCMT 060204E-RF-T7335	● 0.4	✔ 160	0.15	1.0	✔ 120	0.15	1.0	–	–	–	–	–	–	–	–	–	–	–	–
CCMT 060204E-RF-T9325	● 0.4	✔ 205	0.15	1.0	✔ 120	0.15	1.0	✔ 190	0.15	1.0	–	–	–	–	–	–	–	–	–
CCMT 09T304E-RF-T7335	● 0.4	✔ 135	0.20	1.5	✔ 105	0.18	1.5	–	–	–	–	–	–	–	–	–	–	–	–
CCMT 09T304E-RF-T9325	● 0.4	✔ 175	0.20	1.5	✔ 105	0.18	1.5	✔ 165	0.20	1.5	–	–	–	–	–	–	–	–	–
CCMT 09T308E-RF-T5315	● 0.8	✔ 245	0.20	1.5	–	–	–	✔ 230	0.20	1.5	–	–	–	–	–	–	✔ 45	0.14	0.7
CCMT 09T308E-RF-T7335	● 0.8	✔ 165	0.20	1.5	✔ 125	0.18	1.5	–	–	–	–	–	–	–	–	–	–	–	–
CCMT 09T308E-RF-T9325	● 0.8	✔ 210	0.20	1.5	✔ 125	0.18	1.5	✔ 195	0.20	1.5	–	–	–	–	–	–	–	–	–
CCMT 120408E-RF-T5315	● 0.8	✔ 230	0.22	2.2	–	–	–	✔ 215	0.22	2.2	–	–	–	–	–	–	✔ 45	0.13	0.7
CCMT 120408E-RF-T7335	● 0.8	✔ 150	0.22	2.2	✔ 115	0.22	2.2	–	–	–	–	–	–	–	–	–	–	–	–
CCMT 120408E-RF-T9325	● 0.8	✔ 195	0.22	2.2	✔ 115	0.22	2.2	✔ 185	0.22	2.2	–	–	–	–	–	–	–	–	–

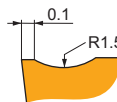

RF chip breaker is robust and the first choice for medium machining of Cast irons. It features slightly positive rake angle and stable, moderate T-land. It's also suitable for Steels, and conditionally for Stainless steels and Hard materials.

DCMT 11T304E-RF-T5315	● 0.4	✔ 175	0.20	0.8	–	–	–	✔ 165	0.20	0.8	–	–	–	–	–	–	✔ 35	0.14	0.3
DCMT 11T304E-RF-T7335	● 0.4	✔ 115	0.20	0.8	✔ 85	0.18	0.8	–	–	–	–	–	–	–	–	–	–	–	–
DCMT 11T304E-RF-T9325	● 0.4	✔ 150	0.20	0.8	✔ 90	0.18	0.8	✔ 140	0.20	0.8	–	–	–	–	–	–	–	–	–
DCMT 11T308E-RF-T5315	● 0.8	✔ 205	0.20	0.8	–	–	–	✔ 190	0.20	0.8	–	–	–	–	–	–	✔ 40	0.10	0.7
DCMT 11T308E-RF-T7335	● 0.8	✔ 140	0.20	0.8	✔ 105	0.18	0.8	–	–	–	–	–	–	–	–	–	–	–	–
DCMT 11T308E-RF-T9325	● 0.8	✔ 175	0.20	0.8	✔ 105	0.18	0.8	✔ 165	0.20	0.8	–	–	–	–	–	–	–	–	–

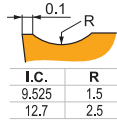
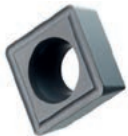

RF chip breaker is robust and the first choice for medium machining of Cast irons. It features slightly positive rake angle and stable, moderate T-land. It's also suitable for Steels, and conditionally for Stainless steels and Hard materials.

SCMT 09T308E-RF-T5315	● 0.8	✔ 255	0.20	1.5	–	–	–	✔ 240	0.20	1.5	–	–	–	–	–	–	✔ 50	0.10	0.7
SCMT 09T308E-RF-T9325	● 0.8	✔ 220	0.20	1.5	✔ 130	0.18	1.5	✔ 205	0.20	1.5	–	–	–	–	–	–	–	–	–
SCMT 120408E-RF-T5315	● 0.8	✔ 240	0.22	2.2	–	–	–	✔ 225	0.22	2.2	–	–	–	–	–	–	✔ 45	0.13	0.7
SCMT 120408E-RF-T7335	● 0.8	✔ 160	0.22	2.2	✔ 120	0.22	2.2	–	–	–	–	–	–	–	–	–	–	–	–
SCMT 120408E-RF-T9325	● 0.8	✔ 205	0.22	2.2	✔ 120	0.22	2.2	✔ 190	0.22	2.2	–	–	–	–	–	–	–	–	–

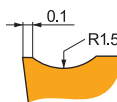

RF chip breaker is robust and the first choice for medium machining of Cast irons. It features slightly positive rake angle and stable, moderate T-land. It's also suitable for Steels, and conditionally for Stainless steels and Hard materials.

TCMT 16T308E-RF-T9325	● 0.8	✔ 175	0.20	1.5	✔ 105	0.18	1.5	✔ 165	0.20	1.5	–	–	–	–	–	–	–	–	–
-----------------------	-------	-------	------	-----	-------	------	-----	-------	------	-----	---	---	---	---	---	---	---	---	---

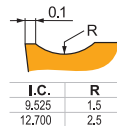

RF chip breaker is robust and the first choice for medium machining of Cast irons. It features slightly positive rake angle and stable, moderate T-land. It's also suitable for Steels, and conditionally for Stainless steels and Hard materials.

WCMT 06T308E-RF-T7335	● 0.8	✔ 165	0.20	1.5	✔ 125	0.18	1.5	–	–	–	–	–	–	–	–	–	–	–	–
WCMT 080412E-RF-T7335	● 1.2	✔ 160	0.22	2.2	✔ 120	0.22	2.2	–	–	–	–	–	–	–	–	–	–	–	–

.CMW

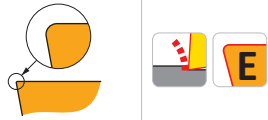

.CMW flat insert is designed for medium machining of Cast irons. It features neutral rake angle without T-land. It's also conditionally suitable for Hard materials.



CCMW

	IC (mm)	D1 (mm)	L (mm)	S (mm)
0602	6.350	2.80	6.40	2.38
09T3	9.525	4.40	9.70	3.97
1204	12.700	5.50	12.90	4.76

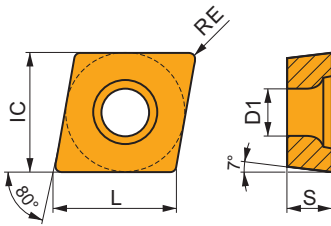

DCMW

	IC (mm)	D1 (mm)	L (mm)	S (mm)
0702	6.350	2.80	7.80	2.38
11T3	9.525	4.40	11.60	3.97

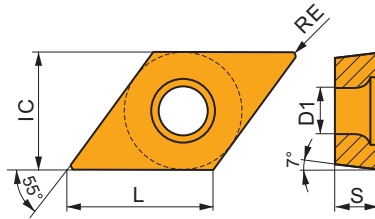

ECMW

	IC (mm)	D1 (mm)	L (mm)	S (mm)
0602	6.350	2.80	6.50	2.38
0803	7.940	3.40	8.20	3.18

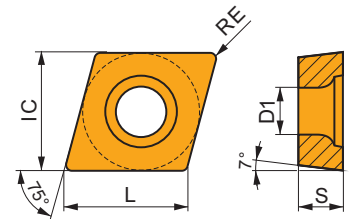

RCMW

	INSD (mm)	D1 (mm)	S (mm)
0602	6.000	2.80	2.38
0803	8.000	3.40	3.18
10T3	10.000	4.40	3.97
1204	12.000	4.40	4.76

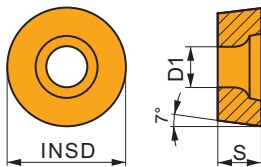

SCMW

	IC (mm)	D1 (mm)	L (mm)	S (mm)
09T3	9.525	4.40	9.53	3.97
1204	12.700	5.50	12.70	4.76

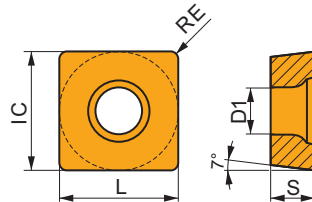

TCMW

	IC (mm)	D1 (mm)	L (mm)	S (mm)
1102	6.350	2.80	11.00	2.38
16T3	9.525	4.40	16.50	3.97

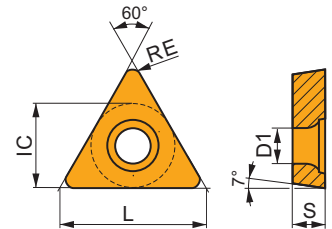

VCGW

	IC (mm)	D1 (mm)	L (mm)	S (mm)
1303	7.940	3.40	13.80	3.18

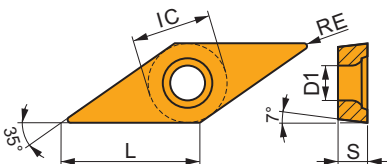

VCMW

	IC (mm)	D1 (mm)	L (mm)	S (mm)
1103	6.350	2.80	11.10	3.18
1604	9.525	4.40	16.60	4.76

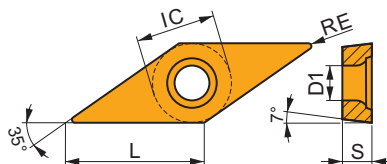

Suitability and starting values for cutting speed (vc), feed (f) and depth of cut (ap). Refer to our Machining Calculator app for further calculations.

Product	RE (mm)	P			M			K			N			S			H		
		vc (m/min)	f (mm/rev)	ap (mm)	vc (m/min)	f (mm/rev)	ap (mm)	vc (m/min)	f (mm/rev)	ap (mm)	vc (m/min)	f (mm/rev)	ap (mm)	vc (m/min)	f (mm/rev)	ap (mm)	vc (m/min)	f (mm/rev)	ap (mm)

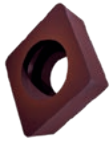

.CMW flat insert is designed for medium machining of Cast irons. It features neutral rake angle without T-land. It's also conditionally suitable for Hard materials.

CCMW 060202:T5305	● 0.2	-	-	-	-	-	-	■ 230	0.08	2.0	-	-	-	-	-	-	■ 45	0.08	0.2
CCMW 060204:T5305	● 0.4	-	-	-	-	-	-	■ 230	0.10	2.0	-	-	-	-	-	-	■ 45	0.10	0.3
CCMW 060204:T5315	● 0.4	-	-	-	-	-	-	■ 195	0.10	2.0	-	-	-	-	-	-	■ 40	0.10	0.3
CCMW 060204:T6310	● 0.4	-	-	-	-	-	-	■ 95	0.10	2.0	-	-	-	-	-	-	■ 20	0.10	0.3
CCMW 060204:T8415	● 0.4	-	-	-	-	-	-	■ 145	0.10	2.0	-	-	-	-	-	-	■ 25	0.10	0.3
CCMW 09T304:T5305	● 0.4	-	-	-	-	-	-	■ 215	0.10	3.0	-	-	-	-	-	-	■ 45	0.10	0.3
CCMW 09T304:T5315	● 0.4	-	-	-	-	-	-	■ 190	0.10	3.0	-	-	-	-	-	-	■ 40	0.10	0.3
CCMW 09T304:T6310	● 0.4	-	-	-	-	-	-	■ 95	0.10	3.0	-	-	-	-	-	-	■ 20	0.10	0.3
CCMW 09T304:T8415	● 0.4	-	-	-	-	-	-	■ 135	0.10	3.0	-	-	-	-	-	-	■ 25	0.10	0.3
CCMW 09T308:T5305	● 0.8	-	-	-	-	-	-	■ 200	0.20	3.0	-	-	-	-	-	-	■ 40	0.11	0.7
CCMW 09T308:T5315	● 0.8	-	-	-	-	-	-	■ 180	0.20	3.0	-	-	-	-	-	-	■ 35	0.11	0.7
CCMW 09T308:T6310	● 0.8	-	-	-	-	-	-	■ 90	0.20	3.0	-	-	-	-	-	-	■ 20	0.11	0.7
CCMW 09T308:T8415	● 0.8	-	-	-	-	-	-	■ 135	0.20	3.0	-	-	-	-	-	-	■ 25	0.11	0.7
CCMW 120404:T5305	● 0.4	-	-	-	-	-	-	■ 210	0.10	4.0	-	-	-	-	-	-	■ 45	0.10	0.3
CCMW 120404:T5315	● 0.4	-	-	-	-	-	-	■ 185	0.10	4.0	-	-	-	-	-	-	■ 35	0.10	0.3
CCMW 120408:T5305	● 0.8	-	-	-	-	-	-	■ 195	0.20	4.0	-	-	-	-	-	-	■ 40	0.11	0.7
CCMW 120408:T5315	● 0.8	-	-	-	-	-	-	■ 175	0.20	4.0	-	-	-	-	-	-	■ 35	0.11	0.7

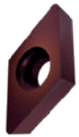

.CMW flat insert is designed for medium machining of Cast irons. It features neutral rake angle without T-land. It's also conditionally suitable for Hard materials.

DCMW 070202:T5305	● 0.2	-	-	-	-	-	-	■ 200	0.08	0.8	-	-	-	-	-	-	■ 40	0.08	0.2
DCMW 070204:T5305	● 0.4	-	-	-	-	-	-	■ 195	0.10	0.8	-	-	-	-	-	-	■ 40	0.10	0.3
DCMW 070204:T6310	● 0.4	-	-	-	-	-	-	■ 85	0.10	0.8	-	-	-	-	-	-	■ 20	0.10	0.3
DCMW 070204:T8415	● 0.4	-	-	-	-	-	-	■ 125	0.10	0.8	-	-	-	-	-	-	■ 20	0.10	0.3
DCMW 11T304:T5305	● 0.4	-	-	-	-	-	-	■ 190	0.10	1.2	-	-	-	-	-	-	■ 40	0.10	0.3
DCMW 11T304:T5315	● 0.4	-	-	-	-	-	-	■ 165	0.10	1.2	-	-	-	-	-	-	■ 35	0.10	0.3
DCMW 11T304:T6310	● 0.4	-	-	-	-	-	-	■ 80	0.10	1.2	-	-	-	-	-	-	■ 20	0.10	0.3
DCMW 11T304:T8415	● 0.4	-	-	-	-	-	-	■ 120	0.10	1.2	-	-	-	-	-	-	■ 20	0.10	0.3
DCMW 11T308:T5305	● 0.8	-	-	-	-	-	-	■ 185	0.18	1.2	-	-	-	-	-	-	■ 35	0.11	0.7
DCMW 11T308:T5315	● 0.8	-	-	-	-	-	-	■ 160	0.18	1.2	-	-	-	-	-	-	■ 30	0.11	0.7
DCMW 11T308:T6310	● 0.8	-	-	-	-	-	-	■ 80	0.18	1.2	-	-	-	-	-	-	■ 20	0.11	0.7
DCMW 11T308:T8415	● 0.8	-	-	-	-	-	-	■ 125	0.18	1.2	-	-	-	-	-	-	■ 20	0.11	0.7



.CMW flat insert is designed for medium machining of Cast irons. It features neutral rake angle without T-land. It's also conditionally suitable for Hard materials.

ECMW 060204:H07	● 0.4	-	-	-	-	-	-	■ 100	0.10	2.0	-	-	-	-	-	-	-	-	-
ECMW 080304:H07	● 0.4	-	-	-	-	-	-	■ 100	0.10	2.5	-	-	-	-	-	-	-	-	-

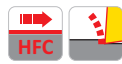

.CMW flat insert is designed for medium machining of Cast irons. It features neutral rake angle without T-land. It's also conditionally suitable for Hard materials.

RCMW 0602M0:T5305	● -	-	-	-	-	-	-	■ 280	0.25	0.6	-	-	-	-	-	-	■ 55	0.17	0.4
RCMW 0602M0:T5315	● -	-	-	-	-	-	-	■ 250	0.25	0.6	-	-	-	-	-	-	■ 50	0.17	0.4
RCMW 0803M0:T5305	● -	-	-	-	-	-	-	■ 255	0.30	0.8	-	-	-	-	-	-	■ 50	0.17	0.5
RCMW 0803M0:T5315	● -	-	-	-	-	-	-	■ 230	0.30	0.8	-	-	-	-	-	-	■ 45	0.17	0.5
RCMW 10T3M0:T5305	● -	-	-	-	-	-	-	■ 225	0.40	1.0	-	-	-	-	-	-	■ 45	0.20	0.7
RCMW 10T3M0:T5315	● -	-	-	-	-	-	-	■ 200	0.40	1.0	-	-	-	-	-	-	■ 40	0.20	0.7
RCMW 1204M0:T5305	● -	-	-	-	-	-	-	■ 205	0.45	1.2	-	-	-	-	-	-	■ 40	0.20	0.8

Suitability and starting values for cutting speed (vc), feed (f) and depth of cut (ap). Refer to our Machining Calculator app for further calculations.

Product	RE (mm)	P			M			K			N			S			H		
		vc (m/min)	f (mm/rev)	ap (mm)	vc (m/min)	f (mm/rev)	ap (mm)	vc (m/min)	f (mm/rev)	ap (mm)	vc (m/min)	f (mm/rev)	ap (mm)	vc (m/min)	f (mm/rev)	ap (mm)	vc (m/min)	f (mm/rev)	ap (mm)



.CMW flat insert is designed for medium machining of Cast irons. It features neutral rake angle without T-land. It's also conditionally suitable for Hard materials.

SCMW 09T304:T5305	● 0.4	-	-	-	-	-	-	■ 240	0.10	2.0	-	-	-	-	-	-	▣ 50	0.10	0.3
SCMW 09T304:T5315	● 0.4	-	-	-	-	-	-	■ 205	0.10	2.0	-	-	-	-	-	-	▣ 40	0.10	0.3
SCMW 09T308:T5305	● 0.8	-	-	-	-	-	-	■ 220	0.20	2.0	-	-	-	-	-	-	▣ 45	0.11	0.7
SCMW 09T308:T5315	● 0.8	-	-	-	-	-	-	■ 190	0.20	2.0	-	-	-	-	-	-	▣ 40	0.11	0.7
SCMW 120408:T5305	● 0.8	-	-	-	-	-	-	■ 205	0.20	4.0	-	-	-	-	-	-	▣ 40	0.11	0.7
SCMW 120408:T5315	● 0.8	-	-	-	-	-	-	■ 185	0.20	4.0	-	-	-	-	-	-	▣ 35	0.11	0.7

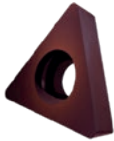

.CMW flat insert is designed for medium machining of Cast irons. It features neutral rake angle without T-land. It's also conditionally suitable for Hard materials.

TCMW 110204:T5305	● 0.4	-	-	-	-	-	-	■ 200	0.10	1.2	-	-	-	-	-	-	▣ 40	0.10	0.3
TCMW 110204:T5315	● 0.4	-	-	-	-	-	-	■ 180	0.10	1.2	-	-	-	-	-	-	▣ 35	0.10	0.3
TCMW 16T304:T5305	● 0.4	-	-	-	-	-	-	■ 195	0.10	1.5	-	-	-	-	-	-	▣ 40	0.10	0.3
TCMW 16T304:T5315	● 0.4	-	-	-	-	-	-	■ 175	0.10	1.5	-	-	-	-	-	-	▣ 35	0.10	0.3
TCMW 16T308:T5305	● 0.8	-	-	-	-	-	-	■ 190	0.18	1.5	-	-	-	-	-	-	▣ 40	0.11	0.7
TCMW 16T308:T5315	● 0.8	-	-	-	-	-	-	■ 165	0.18	1.5	-	-	-	-	-	-	▣ 35	0.11	0.7
TCMW 16T308:T6310	● 0.8	-	-	-	-	-	-	■ 85	0.18	1.5	-	-	-	-	-	-	▣ 20	0.11	0.7
TCMW 16T308:T8415	● 0.8	-	-	-	-	-	-	■ 125	0.18	1.5	-	-	-	-	-	-	▣ 20	0.11	0.7



.CMW flat insert is designed for medium machining of Cast irons. It features neutral rake angle without T-land. It's also conditionally suitable for Hard materials.





VCGW 130302:T5305	● 0.2	-	-	-	-	-	-	■ 170	0.08	1.3	-	-	-	-	-	-	▣ 35	0.08	0.2
VCGW 130304:T5305	● 0.4	-	-	-	-	-	-	■ 165	0.10	1.3	-	-	-	-	-	-	▣ 35	0.10	0.3

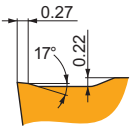

.CMW flat insert is designed for medium machining of Cast irons. It features neutral rake angle without T-land. It's also conditionally suitable for Hard materials.

VCMW 110302:T5305	● 0.2	-	-	-	-	-	-	■ 170	0.08	1.2	-	-	-	-	-	-	▣ 35	0.08	0.2
VCMW 110304:T5305	● 0.4	-	-	-	-	-	-	■ 165	0.10	1.2	-	-	-	-	-	-	▣ 35	0.10	0.3
VCMW 110304:T6310	● 0.4	-	-	-	-	-	-	■ 70	0.10	1.2	-	-	-	-	-	-	▣ 15	0.10	0.3
VCMW 110304:T8415	● 0.4	-	-	-	-	-	-	■ 105	0.10	1.2	-	-	-	-	-	-	▣ 20	0.10	0.3
VCMW 160404:T5305	● 0.4	-	-	-	-	-	-	■ 165	0.10	1.5	-	-	-	-	-	-	▣ 35	0.10	0.3
VCMW 160404:T6310	● 0.4	-	-	-	-	-	-	■ 70	0.10	1.5	-	-	-	-	-	-	▣ 15	0.10	0.3
VCMW 160404:T8415	● 0.4	-	-	-	-	-	-	■ 100	0.10	1.5	-	-	-	-	-	-	▣ 15	0.10	0.3
VCMW 160408:T5305	● 0.8	-	-	-	-	-	-	■ 155	0.18	1.5	-	-	-	-	-	-	▣ 30	0.11	0.7
VCMW 160408:T5315	● 0.8	-	-	-	-	-	-	■ 135	0.18	1.5	-	-	-	-	-	-	▣ 25	0.11	0.7
VCMW 160408:T6310	● 0.8	-	-	-	-	-	-	■ 70	0.18	1.5	-	-	-	-	-	-	▣ 15	0.11	0.7
VCMW 160408:T8415	● 0.8	-	-	-	-	-	-	■ 100	0.18	1.5	-	-	-	-	-	-	▣ 15	0.11	0.7

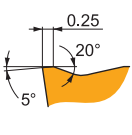
ROUGHING – NAVIGATOR

<p>RM</p>			<p>RM chip breaker is robust and the first choice for roughing of Steels and Cast irons. It features positive rake angle and stable, wide T-land. It's also suitable for Stainless steels, and conditionally for Super-alloys and Hard materials.</p>
<p>RM3</p>			<p>RM3 chip breaker is robust and designed for roughing of Steels and Cast irons. It features positive rake angle and negative, wide T-land. It's also conditionally suitable for Stainless steels and Hard materials.</p>

RM

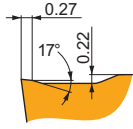

RM chip breaker is robust and the first choice for roughing of Steels and Cast irons. It features positive rake angle and stable, wide T-land. It's also suitable for Stainless steels, and conditionally for Super-alloys and Hard materials.



CCMT

	IC (mm)	D1 (mm)	L (mm)	S (mm)
09T3	9.525	4.40	9.70	3.97
1204	12.700	5.50	12.90	4.76

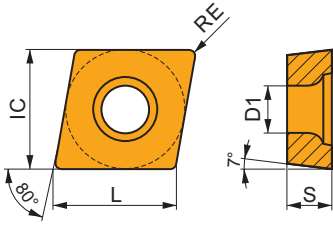

DCMT

	IC (mm)	D1 (mm)	L (mm)	S (mm)
11T3	9.525	4.40	11.60	3.97
1504	12.700	5.50	15.50	4.76

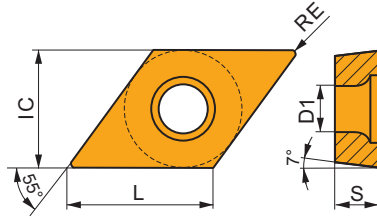

SCMT

	IC (mm)	D1 (mm)	L (mm)	S (mm)
09T3	9.525	4.40	9.53	3.97
1204	12.700	5.50	12.70	4.76

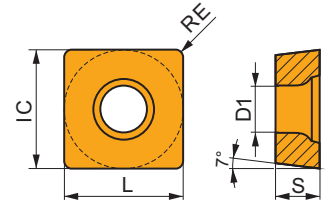

TCMT

	IC (mm)	D1 (mm)	L (mm)	S (mm)
16T3	9.525	4.40	16.50	3.97

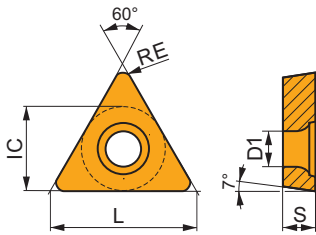

VBMT

	IC (mm)	D1 (mm)	L (mm)	S (mm)
1604	9.525	4.40	16.60	4.76

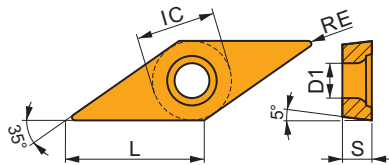

Suitability and starting values for cutting speed (vc), feed (f) and depth of cut (ap). Refer to our Machining Calculator app for further calculations.

Product	RE (mm)	P			M			K			N			S			H		
		vc (m/min)	f (mm/rev)	ap (mm)	vc (m/min)	f (mm/rev)	ap (mm)	vc (m/min)	f (mm/rev)	ap (mm)	vc (m/min)	f (mm/rev)	ap (mm)	vc (m/min)	f (mm/rev)	ap (mm)	vc (m/min)	f (mm/rev)	ap (mm)

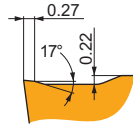
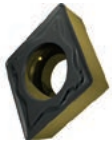

RM chip breaker is robust and the first choice for roughing of Steels and Cast irons. It features positive rake angle and stable, wide T-land. It's also suitable for Stainless steels, and conditionally for Super-alloys and Hard materials.

CCMT 09T304E-RM:T5305	●	0.4	260	0.25	2.2	—	—	—	245	0.25	2.2	—	—	—	—	—	—	50	0.18	0.3
CCMT 09T304E-RM:T5315	●	0.4	235	0.25	2.2	—	—	—	220	0.25	2.2	—	—	—	—	—	—	45	0.18	0.3
CCMT 09T304E-RM:T7335	●	0.4	160	0.25	2.2	120	0.23	2.2	—	—	—	—	—	—	50	0.18	1.8	—	—	—
CCMT 09T304E-RM:T8430	●	0.4	155	0.25	2.2	85	0.23	2.2	130	0.25	2.2	—	—	—	30	0.18	1.8	25	0.18	0.3
CCMT 09T304E-RM:T9325	●	0.4	195	0.25	2.2	115	0.23	2.2	185	0.25	2.2	—	—	—	40	0.18	1.8	—	—	—
CCMT 09T304E-RM:T9415	●	0.4	255	0.25	2.2	—	—	—	240	0.25	2.2	—	—	—	—	—	—	50	0.18	0.3
CCMT 09T308E-RM:T5305	●	0.8	290	0.30	2.2	—	—	—	275	0.30	2.2	—	—	—	—	—	—	55	0.15	0.7
CCMT 09T308E-RM:T5315	●	0.8	265	0.30	2.2	—	—	—	250	0.30	2.2	—	—	—	—	—	—	50	0.15	0.7
CCMT 09T308E-RM:T7335	●	0.8	175	0.30	2.2	135	0.27	2.2	—	—	—	—	—	—	55	0.24	1.8	—	—	—
CCMT 09T308E-RM:T8430	●	0.8	180	0.30	2.2	95	0.27	2.2	145	0.30	2.2	—	—	—	35	0.24	1.8	30	0.15	0.7
CCMT 09T308E-RM:T9325	●	0.8	215	0.30	2.2	125	0.27	2.2	200	0.30	2.2	—	—	—	45	0.24	1.8	—	—	—
CCMT 09T308E-RM:T9415	●	0.8	285	0.30	2.2	—	—	—	270	0.30	2.2	—	—	—	—	—	—	55	0.15	0.7
CCMT 120408E-RM:T5305	●	0.8	290	0.30	2.7	—	—	—	275	0.30	2.7	—	—	—	—	—	—	55	0.15	0.7
CCMT 120408E-RM:T5315	●	0.8	260	0.30	2.7	—	—	—	245	0.30	2.7	—	—	—	—	—	—	50	0.15	0.7
CCMT 120408E-RM:T7335	●	0.8	175	0.30	2.7	135	0.27	2.7	—	—	—	—	—	—	55	0.24	2.2	—	—	—
CCMT 120408E-RM:T8430	●	0.8	175	0.30	2.7	95	0.27	2.7	140	0.30	2.7	—	—	—	35	0.24	2.2	30	0.15	0.7
CCMT 120408E-RM:T9325	●	0.8	210	0.30	2.7	125	0.27	2.7	195	0.30	2.7	—	—	—	45	0.24	2.2	—	—	—
CCMT 120408E-RM:T9415	●	0.8	280	0.30	2.7	—	—	—	265	0.30	2.7	—	—	—	—	—	—	55	0.15	0.7
CCMT 120412E-RM:T8430	●	1.2	180	0.33	2.7	95	0.30	2.7	145	0.33	2.7	—	—	—	35	0.23	2.2	30	0.17	1.0
CCMT 120412E-RM:T9325	●	1.2	215	0.33	2.7	125	0.30	2.7	200	0.33	2.7	—	—	—	45	0.23	2.2	—	—	—
CCMT 120412E-RM:T9415	●	1.2	280	0.33	2.7	—	—	—	265	0.33	2.7	—	—	—	—	—	—	55	0.17	1.0

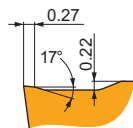

RM chip breaker is robust and the first choice for roughing of Steels and Cast irons. It features positive rake angle and stable, wide T-land. It's also suitable for Stainless steels, and conditionally for Super-alloys and Hard materials.

DCMT 11T304E-RM:T5305	●	0.4	250	0.20	1.0	—	—	—	235	0.20	1.0	—	—	—	—	—	—	50	0.14	0.3
DCMT 11T304E-RM:T5315	●	0.4	220	0.20	1.0	—	—	—	205	0.20	1.0	—	—	—	—	—	—	40	0.14	0.3
DCMT 11T304E-RM:T7335	●	0.4	145	0.20	1.0	110	0.18	1.0	—	—	—	—	—	—	45	0.14	0.8	—	—	—
DCMT 11T304E-RM:T8430	●	0.4	150	0.20	1.0	80	0.18	1.0	125	0.20	1.0	—	—	—	30	0.14	0.8	25	0.14	0.3
DCMT 11T304E-RM:T9325	●	0.4	185	0.20	1.0	110	0.18	1.0	175	0.20	1.0	—	—	—	40	0.14	0.8	—	—	—
DCMT 11T304E-RM:T9415	●	0.4	235	0.20	1.0	—	—	—	220	0.20	1.0	—	—	—	—	—	—	45	0.14	0.3
DCMT 11T308E-RM:T5305	●	0.8	270	0.27	0.8	—	—	—	255	0.27	0.8	—	—	—	—	—	—	50	0.14	0.7
DCMT 11T308E-RM:T5315	●	0.8	240	0.27	0.8	—	—	—	225	0.27	0.8	—	—	—	—	—	—	45	0.14	0.7
DCMT 11T308E-RM:T7335	●	0.8	165	0.27	0.8	125	0.24	0.8	—	—	—	—	—	—	50	0.19	0.6	—	—	—
DCMT 11T308E-RM:T8430	●	0.8	165	0.27	0.8	90	0.24	0.8	135	0.27	0.8	—	—	—	35	0.19	0.6	25	0.14	0.7
DCMT 11T308E-RM:T9325	●	0.8	200	0.27	0.8	120	0.24	0.8	190	0.27	0.8	—	—	—	45	0.19	0.6	—	—	—
DCMT 11T308E-RM:T9415	●	0.8	255	0.27	1.0	—	—	—	240	0.27	1.0	—	—	—	—	—	—	50	0.14	0.7
DCMT 11T312E-RM:T8430	●	1.2	170	0.27	1.2	90	0.24	1.2	135	0.27	1.2	—	—	—	35	0.19	1.2	25	0.14	0.9
DCMT 11T312E-RM:T9315	●	1.2	225	0.27	1.2	—	—	—	210	0.27	1.2	—	—	—	—	—	—	45	0.14	0.9
DCMT 11T312E-RM:T9325	●	1.2	200	0.27	1.2	120	0.24	1.2	190	0.27	1.2	—	—	—	45	0.19	1.2	—	—	—
DCMT 11T312E-RM:T9415	●	1.2	260	0.27	1.2	—	—	—	245	0.27	1.2	—	—	—	—	—	—	50	0.14	0.9
DCMT 150408E-RM:T8430	●	0.8	150	0.27	1.9	80	0.24	1.9	125	0.27	1.9	—	—	—	30	0.22	1.5	25	0.14	0.7
DCMT 150408E-RM:T9325	●	0.8	180	0.27	1.9	105	0.24	1.9	170	0.27	1.9	—	—	—	40	0.22	1.5	—	—	—
DCMT 150408E-RM:T9415	●	0.8	235	0.27	1.9	—	—	—	220	0.27	1.9	—	—	—	—	—	—	45	0.14	0.7

Suitability and starting values for cutting speed (vc), feed (f) and depth of cut (ap). Refer to our Machining Calculator app for further calculations.

Product	RE (mm)	P			M			K			N			S			H		
		vc (m/min)	f (mm/rev)	ap (mm)	vc (m/min)	f (mm/rev)	ap (mm)	vc (m/min)	f (mm/rev)	ap (mm)	vc (m/min)	f (mm/rev)	ap (mm)	vc (m/min)	f (mm/rev)	ap (mm)	vc (m/min)	f (mm/rev)	ap (mm)

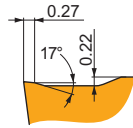

RM chip breaker is robust and the first choice for roughing of Steels and Cast irons. It features positive rake angle and stable, wide T-land. It's also suitable for Stainless steels, and conditionally for Super-alloys and Hard materials.

SCMT 09T308E-RM-T5315	0.8	275	0.30	2.0	-	-	-	260	0.30	2.0	-	-	-	-	-	-	55	0.15	0.7
SCMT 09T308E-RM-T7335	0.8	190	0.30	2.0	145	0.27	2.0	-	-	-	-	-	-	60	0.24	1.6	-	-	-
SCMT 09T308E-RM-T8430	0.8	190	0.30	2.0	105	0.27	2.0	155	0.30	2.0	-	-	-	40	0.24	1.6	30	0.15	0.7
SCMT 09T308E-RM-T9325	0.8	230	0.30	2.0	135	0.27	2.0	215	0.30	2.0	-	-	-	50	0.24	1.6	-	-	-
SCMT 09T308E-RM-T9415	0.8	295	0.30	2.0	-	-	-	280	0.30	2.0	-	-	-	-	-	-	55	0.15	0.7
SCMT 120408E-RM-T5305	0.8	305	0.30	2.3	-	-	-	285	0.30	2.3	-	-	-	-	-	-	60	0.15	0.7
SCMT 120408E-RM-T5315	0.8	275	0.30	2.3	-	-	-	260	0.30	2.3	-	-	-	-	-	-	55	0.15	0.7
SCMT 120408E-RM-T7335	0.8	185	0.30	2.3	140	0.27	2.3	-	-	-	-	-	-	60	0.24	1.8	-	-	-
SCMT 120408E-RM-T8430	0.8	190	0.30	2.3	105	0.27	2.3	155	0.30	2.3	-	-	-	40	0.24	1.8	30	0.15	0.7
SCMT 120408E-RM-T9325	0.8	225	0.30	2.3	135	0.27	2.3	210	0.30	2.3	-	-	-	50	0.24	1.8	-	-	-
SCMT 120408E-RM-T9415	0.8	295	0.30	2.3	-	-	-	280	0.30	2.3	-	-	-	-	-	-	55	0.15	0.7

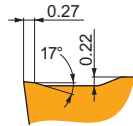

RM chip breaker is robust and the first choice for roughing of Steels and Cast irons. It features positive rake angle and stable, wide T-land. It's also suitable for Stainless steels, and conditionally for Super-alloys and Hard materials.

TCMT 16T308E-RM-T5305	0.8	265	0.27	1.9	-	-	-	250	0.27	1.9	-	-	-	-	-	-	50	0.14	0.7
TCMT 16T308E-RM-T5315	0.8	235	0.27	1.9	-	-	-	220	0.27	1.9	-	-	-	-	-	-	45	0.14	0.7
TCMT 16T308E-RM-T7335	0.8	155	0.27	1.9	120	0.24	1.9	-	-	-	-	-	-	50	0.19	1.5	-	-	-
TCMT 16T308E-RM-T8430	0.8	165	0.27	1.9	90	0.24	1.9	135	0.27	1.9	-	-	-	35	0.19	1.5	25	0.14	0.7
TCMT 16T308E-RM-T9325	0.8	195	0.27	1.9	115	0.24	1.9	185	0.27	1.9	-	-	-	40	0.19	1.5	-	-	-
TCMT 16T308E-RM-T9415	0.8	250	0.27	1.9	-	-	-	235	0.27	1.9	-	-	-	-	-	-	50	0.14	0.7
TCMT 16T312E-RM-T5305	1.2	280	0.27	1.9	-	-	-	265	0.27	1.9	-	-	-	-	-	-	55	0.14	0.9
TCMT 16T312E-RM-T5315	1.2	250	0.27	1.9	-	-	-	235	0.27	1.9	-	-	-	-	-	-	50	0.14	0.9
TCMT 16T312E-RM-T8430	1.2	170	0.27	1.9	90	0.24	1.9	135	0.27	1.9	-	-	-	35	0.19	1.5	25	0.14	0.9
TCMT 16T312E-RM-T9325	1.2	205	0.27	1.9	120	0.24	1.9	190	0.27	1.9	-	-	-	45	0.19	1.5	-	-	-
TCMT 16T312E-RM-T9415	1.2	265	0.27	1.9	-	-	-	250	0.27	1.9	-	-	-	-	-	-	50	0.14	0.9

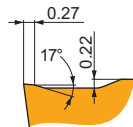

RM chip breaker is robust and the first choice for roughing of Steels and Cast irons. It features positive rake angle and stable, wide T-land. It's also suitable for Stainless steels, and conditionally for Super-alloys and Hard materials.

VBMT 160404E-RM-T5305	0.4	270	0.12	1.2	-	-	-	255	0.12	1.2	-	-	-	-	-	-	50	0.12	0.3
VBMT 160404E-RM-T5315	0.4	235	0.12	1.2	-	-	-	220	0.12	1.2	-	-	-	-	-	-	45	0.12	0.3
VBMT 160404E-RM-T7335	0.4	140	0.18	1.2	105	0.16	1.2	-	-	-	-	-	-	45	0.16	1.0	-	-	-
VBMT 160404E-RM-T8430	0.4	170	0.12	1.2	90	0.11	1.2	135	0.12	1.2	-	-	-	35	0.11	1.0	25	0.12	0.3
VBMT 160404E-RM-T9325	0.4	170	0.20	1.2	100	0.18	1.2	160	0.20	1.2	-	-	-	35	0.18	1.0	-	-	-
VBMT 160404E-RM-T9415	0.4	255	0.12	1.2	-	-	-	240	0.12	1.2	-	-	-	-	-	-	50	0.12	0.3
VBMT 160408E-RM-T5305	0.8	285	0.17	1.2	-	-	-	270	0.17	1.2	-	-	-	-	-	-	55	0.11	0.7
VBMT 160408E-RM-T5315	0.8	250	0.17	1.2	-	-	-	235	0.17	1.2	-	-	-	-	-	-	50	0.11	0.7
VBMT 160408E-RM-T7335	0.8	155	0.20	1.2	120	0.18	1.2	-	-	-	-	-	-	50	0.18	1.0	-	-	-
VBMT 160408E-RM-T8430	0.8	175	0.17	1.2	95	0.15	1.2	140	0.17	1.2	-	-	-	35	0.12	1.0	30	0.11	0.7
VBMT 160408E-RM-T9325	0.8	200	0.20	1.2	120	0.18	1.2	190	0.20	1.2	-	-	-	45	0.18	1.0	-	-	-
VBMT 160408E-RM-T9415	0.8	270	0.17	1.2	-	-	-	255	0.17	1.2	-	-	-	-	-	-	50	0.12	0.7
VBMT 160412E-RM-T7335	1.2	150	0.27	1.2	115	0.24	1.2	-	-	-	-	-	-	45	0.19	1.0	-	-	-
VBMT 160412E-RM-T8430	1.2	155	0.27	1.2	85	0.24	1.2	130	0.27	1.2	-	-	-	30	0.19	1.0	25	0.14	0.9
VBMT 160412E-RM-T9325	1.2	185	0.27	1.2	110	0.24	1.2	175	0.27	1.2	-	-	-	40	0.19	1.0	-	-	-
VBMT 160412E-RM-T9415	1.2	240	0.27	1.2	-	-	-	225	0.27	1.2	-	-	-	-	-	-	45	0.14	0.9

RM3

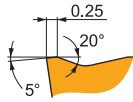

RM3 chip breaker is robust and designed for roughing of Steels and Cast irons. It features positive rake angle and negative, wide T-land. It's also conditionally suitable for Stainless steels and Hard materials.



CCMT

	IC (mm)	D1 (mm)	L (mm)	S (mm)
1204	12.700	5.50	12.90	4.76

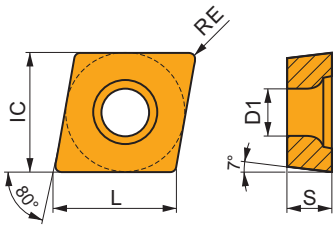

RCMT

	INSD (mm)	D1 (mm)	S (mm)
0803	8.000	3.40	3.18
1204	12.000	4.40	4.76
1606	16.000	5.50	6.35

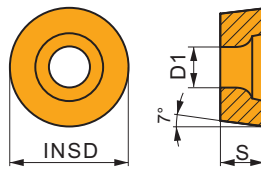

SCMT

	IC (mm)	D1 (mm)	L (mm)	S (mm)
1204	12.700	5.50	12.70	4.76

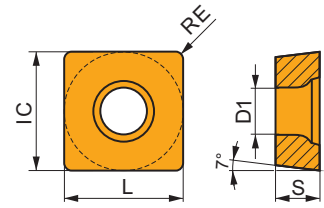

TCMT

	IC (mm)	D1 (mm)	L (mm)	S (mm)
16T3	9.525	4.40	16.50	3.97

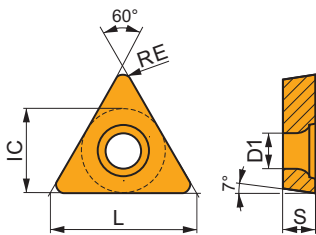

Suitability and starting values for cutting speed (vc), feed (f) and depth of cut (ap). Refer to our Machining Calculator app for further calculations.

Product	RE (mm)	P			M			K			N			S			H		
		vc (m/min)	f (mm/rev)	ap (mm)	vc (m/min)	f (mm/rev)	ap (mm)	vc (m/min)	f (mm/rev)	ap (mm)	vc (m/min)	f (mm/rev)	ap (mm)	vc (m/min)	f (mm/rev)	ap (mm)	vc (m/min)	f (mm/rev)	ap (mm)

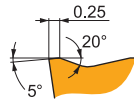
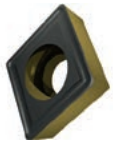

RM3 chip breaker is robust and designed for roughing of Steels and Cast irons. It features positive rake angle and negative, wide T-land. It's also conditionally suitable for Stainless steels and Hard materials.

CCMT 120404E-RM3:T9325	● 0.4	■ 165	■ 0.25	■ 2.5	■ 95	■ 0.25	■ 2.5	■ 155	■ 0.25	■ 2.5	■ -	■ -	■ -	■ -	■ -	■ -	■ -	■ -	■ -
CCMT 120404E-RM3:T9415	● 0.4	■ 215	■ 0.25	■ 2.5	■ -	■ -	■ -	■ 200	■ 0.25	■ 2.5	■ -	■ -	■ -	■ -	■ -	■ -	■ 40	■ 0.13	■ 0.3
CCMT 120408E-RM3:T6310	● 0.8	■ 145	■ 0.27	■ 2.5	■ 100	■ 0.27	■ 2.5	■ 115	■ 0.27	■ 2.5	■ -	■ -	■ -	■ -	■ -	■ -	■ 25	■ 0.14	■ 0.7
CCMT 120408E-RM3:T9325	● 0.8	■ 195	■ 0.27	■ 2.5	■ 115	■ 0.27	■ 2.5	■ 185	■ 0.27	■ 2.5	■ -	■ -	■ -	■ -	■ -	■ -	■ -	■ -	■ -
CCMT 120408E-RM3:T9415	● 0.8	■ 250	■ 0.27	■ 2.5	■ -	■ -	■ -	■ 235	■ 0.27	■ 2.5	■ -	■ -	■ -	■ -	■ -	■ -	■ 50	■ 0.14	■ 0.7
CCMT 120412E-RM3:T9415	● 1.2	■ 255	■ 0.30	■ 2.5	■ -	■ -	■ -	■ 240	■ 0.30	■ 2.5	■ -	■ -	■ -	■ -	■ -	■ -	■ 50	■ 0.15	■ 1.0

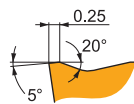
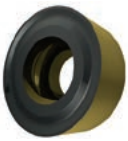

RM3 chip breaker is robust and designed for roughing of Steels and Cast irons. It features positive rake angle and negative, wide T-land. It's also conditionally suitable for Stainless steels and Hard materials.

RCMT 0803MOE-RM3:T9415	● -	■ 275	■ 0.50	■ 1.3	■ -	■ -	■ -	■ 260	■ 0.50	■ 1.3	■ -	■ -	■ -	■ -	■ -	■ -	■ 55	■ 0.25	■ 0.5
RCMT 1204MOE-RM3:H07	● -	■ -	■ -	■ -	■ 65	■ 0.54	■ 1.8	■ 105	■ 0.60	■ 1.8	■ -	■ -	■ -	■ -	■ -	■ -	■ -	■ -	■ -
RCMT 1204MOE-RM3:T7325	● -	■ 165	■ 0.60	■ 1.8	■ 125	■ 0.54	■ 1.8	■ -	■ -	■ -	■ -	■ -	■ -	■ -	■ -	■ -	■ -	■ -	■ -
RCMT 1204MOE-RM3:T8430	● -	■ 150	■ 0.60	■ 1.8	■ 80	■ 0.54	■ 1.8	■ 125	■ 0.60	■ 1.8	■ -	■ -	■ -	■ -	■ -	■ -	■ 25	■ 0.30	■ 0.8
RCMT 1204MOE-RM3:T9415	● -	■ 255	■ 0.60	■ 1.8	■ -	■ -	■ -	■ 240	■ 0.60	■ 1.8	■ -	■ -	■ -	■ -	■ -	■ -	■ 50	■ 0.30	■ 0.8
RCMT 1606MOE-RM3:T7325	● -	■ 160	■ 0.65	■ 2.0	■ 120	■ 0.59	■ 2.0	■ -	■ -	■ -	■ -	■ -	■ -	■ -	■ -	■ -	■ -	■ -	■ -
RCMT 1606MOE-RM3:T8430	● -	■ 145	■ 0.65	■ 2.0	■ 80	■ 0.59	■ 2.0	■ 120	■ 0.65	■ 2.0	■ -	■ -	■ -	■ -	■ -	■ -	■ 25	■ 0.33	■ 1.1
RCMT 1606MOE-RM3:T9415	● -	■ 245	■ 0.65	■ 2.0	■ -	■ -	■ -	■ 230	■ 0.65	■ 2.0	■ -	■ -	■ -	■ -	■ -	■ -	■ 45	■ 0.33	■ 1.1

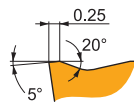
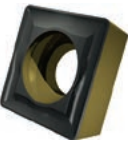

RM3 chip breaker is robust and designed for roughing of Steels and Cast irons. It features positive rake angle and negative, wide T-land. It's also conditionally suitable for Stainless steels and Hard materials.



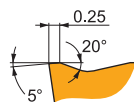
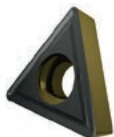

SCMT 120408E-RM3:T8430	● 0.8	■ 170	■ 0.27	■ 2.3	■ 90	■ 0.27	■ 2.3	■ 135	■ 0.27	■ 2.3	■ -	■ -	■ -	■ -	■ -	■ -	■ 25	■ 0.14	■ 0.7
SCMT 120408E-RM3:T9325	● 0.8	■ 205	■ 0.27	■ 2.3	■ 120	■ 0.27	■ 2.3	■ 190	■ 0.27	■ 2.3	■ -	■ -	■ -	■ -	■ -	■ -	■ -	■ -	■ -
SCMT 120408E-RM3:T9335	● 0.8	■ 175	■ 0.27	■ 2.3	■ 105	■ 0.27	■ 2.3	■ -	■ -	■ -	■ -	■ -	■ -	■ -	■ -	■ -	■ -	■ -	■ -
SCMT 120408E-RM3:T9415	● 0.8	■ 265	■ 0.27	■ 2.3	■ -	■ -	■ -	■ 250	■ 0.27	■ 2.3	■ -	■ -	■ -	■ -	■ -	■ -	■ 50	■ 0.14	■ 0.7
SCMT 120412E-RM3:T9325	● 1.2	■ 205	■ 0.30	■ 2.3	■ 120	■ 0.27	■ 2.3	■ 190	■ 0.30	■ 2.3	■ -	■ -	■ -	■ -	■ -	■ -	■ -	■ -	■ -

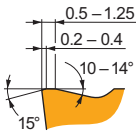

RM3 chip breaker is robust and designed for roughing of Steels and Cast irons. It features positive rake angle and negative, wide T-land. It's also conditionally suitable for Stainless steels and Hard materials.

TCMT 16T304E-RM3:T6310	● 0.4	■ 115	■ 0.20	■ 2.0	■ 80	■ 0.20	■ 2.0	■ 90	■ 0.20	■ 2.0	■ -	■ -	■ -	■ -	■ -	■ -	■ 20	■ 0.14	■ 0.3
TCMT 16T304E-RM3:T8415	● 0.4	■ 150	■ 0.20	■ 2.0	■ 75	■ 0.20	■ 2.0	■ 135	■ 0.20	■ 2.0	■ -	■ -	■ -	■ -	■ -	■ -	■ 25	■ 0.14	■ 0.3
TCMT 16T304E-RM3:T8430	● 0.4	■ 130	■ 0.20	■ 2.0	■ 70	■ 0.20	■ 2.0	■ 105	■ 0.20	■ 2.0	■ -	■ -	■ -	■ -	■ -	■ -	■ 20	■ 0.14	■ 0.3
TCMT 16T304E-RM3:T9325	● 0.4	■ 145	■ 0.25	■ 2.0	■ 85	■ 0.25	■ 2.0	■ 135	■ 0.25	■ 2.0	■ -	■ -	■ -	■ -	■ -	■ -	■ -	■ -	■ -
TCMT 16T304E-RM3:T9335	● 0.4	■ 125	■ 0.25	■ 2.0	■ 75	■ 0.25	■ 2.0	■ -	■ -	■ -	■ -	■ -	■ -	■ -	■ -	■ -	■ -	■ -	■ -
TCMT 16T304E-RM3:T9415	● 0.4	■ 205	■ 0.20	■ 2.0	■ -	■ -	■ -	■ 190	■ 0.20	■ 2.0	■ -	■ -	■ -	■ -	■ -	■ -	■ 40	■ 0.14	■ 0.3
TCMT 16T308E-RM3:T6310	● 0.8	■ 125	■ 0.27	■ 2.0	■ 90	■ 0.27	■ 2.0	■ 100	■ 0.27	■ 2.0	■ -	■ -	■ -	■ -	■ -	■ -	■ 25	■ 0.14	■ 0.7
TCMT 16T308E-RM3:T8415	● 0.8	■ 160	■ 0.27	■ 2.0	■ 85	■ 0.27	■ 2.0	■ 145	■ 0.27	■ 2.0	■ -	■ -	■ -	■ -	■ -	■ -	■ 25	■ 0.14	■ 0.7
TCMT 16T308E-RM3:T8430	● 0.8	■ 135	■ 0.27	■ 2.0	■ 75	■ 0.27	■ 2.0	■ 110	■ 0.27	■ 2.0	■ -	■ -	■ -	■ -	■ -	■ -	■ 20	■ 0.14	■ 0.7
TCMT 16T308E-RM3:T9325	● 0.8	■ 170	■ 0.27	■ 2.0	■ 100	■ 0.27	■ 2.0	■ 160	■ 0.27	■ 2.0	■ -	■ -	■ -	■ -	■ -	■ -	■ -	■ -	■ -
TCMT 16T308E-RM3:T9335	● 0.8	■ 145	■ 0.27	■ 2.0	■ 85	■ 0.27	■ 2.0	■ -	■ -	■ -	■ -	■ -	■ -	■ -	■ -	■ -	■ -	■ -	■ -
TCMT 16T308E-RM3:T9415	● 0.8	■ 220	■ 0.27	■ 2.0	■ -	■ -	■ -	■ 205	■ 0.27	■ 2.0	■ -	■ -	■ -	■ -	■ -	■ -	■ 40	■ 0.14	■ 0.7

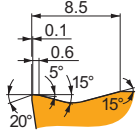
HEAVY ROUGHING – NAVIGATOR

<p>OR</p>			<p>OR chip breaker is robust and the first choice for heavy roughing of Stainless steels. It features positive rake angle and negative/stable, extra-wide double T-land. It's also suitable for Steels, Cast irons, and conditionally for Super-alloys.</p>
<p>DR4</p>			<p>DR4 chip breaker is robust and the first choice for heavy roughing of Steels. It features positive rake angle and negative/stable, extra-wide double T-land. It's also suitable for Cast irons, and conditionally for Stainless steels.</p>

OR

OR chip breaker is robust and the first choice for heavy roughing of Stainless steels. It features positive rake angle and negative/stable, extra-wide double T-land. It's also suitable for Steels, Cast irons, and conditionally for Super-alloys.

PRAMET

DR4

DR4 chip breaker is robust and the first choice for heavy roughing of Steels. It features positive rake angle and negative/stable, extra-wide double T-land. It's also suitable for Cast irons, and conditionally for Stainless steels.

PRAMET

SCMT

	IC (mm)	D1 (mm)	L (mm)	S (mm)
2509	25.400	8.70	25.40	9.53
3809	38.100	8.70	38.10	9.53

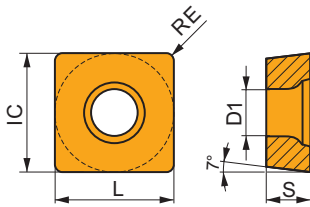

Suitability and starting values for cutting speed (vc), feed (f) and depth of cut (ap). Refer to our Machining Calculator app for further calculations.

Product	RE (mm)	P			M			K			N			S			H		
		vc (m/min)	f (mm/rev)	ap (mm)	vc (m/min)	f (mm/rev)	ap (mm)	vc (m/min)	f (mm/rev)	ap (mm)	vc (m/min)	f (mm/rev)	ap (mm)	vc (m/min)	f (mm/rev)	ap (mm)			

OR chip breaker is robust and the first choice for heavy roughing of Stainless steels. It features positive rake angle and negative/stable, extra-wide double T-land. It's also suitable for Steels, Cast irons, and conditionally for Super-alloys.

SCMT 250924E-OR:T9226	☼	2.4	■	80	1.00	10.0	■	45	0.90	10.0	▣	75	1.00	10.0	■	15	0.70	8.0	■	—	—	—
SCMT 250924E-OR:T9325	☼	2.4	■	90	1.00	10.0	■	50	0.90	10.0	▣	85	1.00	10.0	■	20	0.70	8.0	■	—	—	—
SCMT 250924E-OR:T9335	☼	2.4	■	70	1.00	10.0	■	40	0.90	10.0	■	—	—	—	■	15	0.70	8.0	■	—	—	—
SCMT 380932E-OR:6635	☼	3.2	■	60	1.20	18.0	■	35	1.08	18.0	■	—	—	—	■	15	1.08	9.9	■	—	—	—
SCMT 380932E-OR:T9315	☼	3.2	■	85	1.20	18.0	■	—	—	—	▣	80	1.20	18.0	■	—	—	—	■	—	—	—
SCMT 380932E-OR:T9325	☼	3.2	■	80	1.20	18.0	■	45	1.08	18.0	▣	75	1.20	18.0	■	15	1.08	9.9	■	—	—	—
SCMT 380932E-OR:T9335	☼	3.2	■	60	1.20	18.0	■	35	1.08	18.0	■	—	—	—	■	10	1.08	9.9	■	—	—	—

DR4 chip breaker is robust and the first choice for heavy roughing of Steels. It features positive rake angle and negative/stable, extra-wide double T-land. It's also suitable for Cast irons, and conditionally for Stainless steels.

SCMT 380932E-DR4:T9335	☼	3.2	■	50	1.33	16.0	▣	30	1.20	16.0	■	—	—	—	■	—	—	—	■	—	—	—
-------------------------------	---	-----	---	----	------	------	---	----	------	------	---	---	---	---	---	---	---	---	---	---	---	---

CC

ISO TURNING – EXTERNAL – NAVIGATOR

<p>SCAC(RL) EXT 90°</p> <p>CC..</p> <p>77</p>	<p>SCBC(RL) EXT 75°</p> <p>CC..</p> <p>78</p>	<p>SCDCR EXT 45°</p> <p>CC..</p> <p>79</p>	<p>SCFC(RL) EXT 90°</p> <p>CC..</p> <p>80</p>
<p>SCLC(RL) EXT 95°</p> <p>CC..</p> <p>81</p>	<p>C.-SCLC(RL) EXT 95°</p> <p>CC..</p> <p>83</p>		

CC

ISO TURNING – INTERNAL – NAVIGATOR

<p>SCFC(RL) INT 90°</p> <p>CC..</p> <p>84</p>	<p>SCKC(RL) INT 75°</p> <p>CC..</p> <p>85</p>	<p>SCLC(RL) INT 45°</p> <p>CC..</p> <p>86</p>	<p>SCXC(RL) INT 90°</p> <p>CC..</p> <p>88</p>
<p>C.-SCLC(RL) INT 95°</p> <p>CC..</p> <p>89</p>			

DC

ISO TURNING – EXTERNAL – NAVIGATOR

<p>SDFC(RL) EXT 91°</p> <p>DC..</p> <p>90</p>	<p>SDJC(RL) EXT 93°</p> <p>DC..</p> <p>30°</p> <p>91</p>	<p>SDNCN EXT 62°30'</p> <p>DC..</p> <p>62,5°</p> <p>93</p>	<p>SDUCL EXT 93°</p> <p>DC..</p> <p>94</p>
<p>SDXC(RL) EXT 62°30'</p> <p>DC..</p> <p>62,5°</p> <p>95</p>	<p>C.-SDJC(RL) EXT 93°</p> <p>DC..</p> <p>30°</p> <p>96</p>	<p>C.-SDNCN EXT 62°30'</p> <p>DC..</p> <p>62,5°</p> <p>97</p>	

DC

ISO TURNING – INTERNAL – NAVIGATOR

<p>SDQC(RL) INT 95°</p> <p>DC..</p> <p>15°</p> <p>98</p>	<p>SDUC(RL) INT 93°</p> <p>DC..</p> <p>27°</p> <p>99</p>	<p>SDUC(RL)-E INT 62°30'</p> <p>DC..</p> <p>27°</p> <p>100</p>	<p>SDZC(RL) INT 90°</p> <p>DC..</p> <p>27°</p> <p>101</p>
<p>C.-SDUC(RL) INT 93°</p> <p>DC..</p> <p>27°</p> <p>102</p>			

EC

ISO TURNING – EXTERNAL – NAVIGATOR

SEGC(RL) EXT 90°

EC..

15°

103

EC

ISO TURNING – INTERNAL – NAVIGATOR

SEUC(RL) INT 93°

EC..

93°

104

EP

ISO TURNING – INTERNAL – NAVIGATOR

SELP(RL) INT 95°

EP..

95°

105

SELP(RL)-E INT 95°

EP..

95°

106

SEUP(RL) INT 93°

EP..

93°

107

SEXP(RL) INT 52°30'

EP..

52°

52°

108

SEXP(RL)-E INT 52°30'

EP..

52°

52°

109

RC

ISO TURNING – EXTERNAL – NAVIGATOR

<p>PRDCN EXT</p> <p>RC..</p> <p>90°</p> <p>110</p>	<p>PRSC(RL) EXT</p> <p>RC..</p> <p>27°</p> <p>111</p>	<p>SRDC(RL) EXT</p> <p>RC..</p> <p>112</p>	<p>SRDCN EXT</p> <p>RC..</p> <p>90°</p> <p>113</p>
<p>SRCS(RL) EXT</p> <p>RC..</p> <p>27°</p> <p>114</p>	<p>C.-SRDCN EXT</p> <p>RC..</p> <p>90°</p> <p>116</p>		

RC

ISO TURNING – HEAVY ROUGHING – NAVIGATOR

<p>KHP-RSCR/L</p> <p>RC..</p> <p>117</p>	<p>DKH(RL)</p> <p>118</p>
---	----------------------------------

SC

ISO TURNING – EXTERNAL – NAVIGATOR

SSBC(RL) EXT 75°

SC..

SSDCN EXT 45°

SC..

SSKC(RL) EXT 75°

SC..

SC

ISO TURNING – INTERNAL – NAVIGATOR

SSSC(RL) INT 45°

SC..

SC

ISO TURNING – HEAVY ROUGHING – NAVIGATOR

KHS-SBCR 75°

SC..

DKH(RL)

TC

ISO TURNING – EXTERNAL – NAVIGATOR

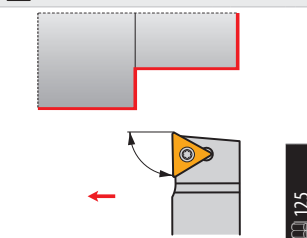
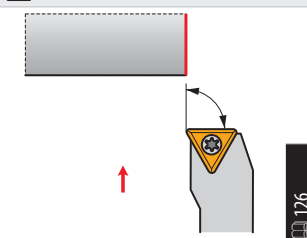
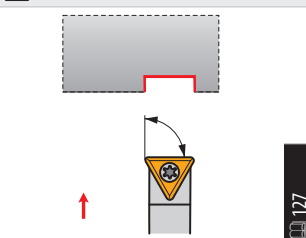
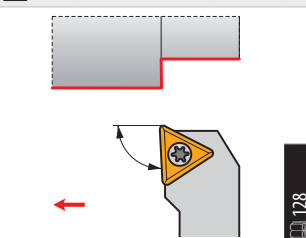
STAC(RL) EXT 90° TC..	STFC(RL) EXT 90° TC..	STFC(RL)-A EXT 90° TC..	STJC(RL) EXT 93° TC..
			

TC

ISO TURNING – INTERNAL – NAVIGATOR

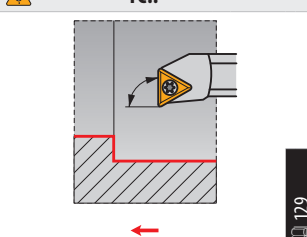
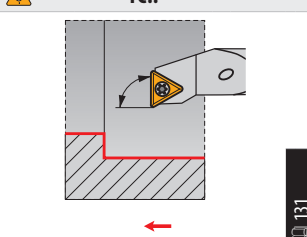
STFC(RL) INT 90° TC..	STFC(RL)-E INT 90° TC..
	

VB

ISO TURNING – EXTERNAL – NAVIGATOR

<p>SVHB(C)(RL) EXT 107°30'</p> <p>VB, VC..</p>	<p>SVJB(C)(RL) EXT 93°</p> <p>VB, VC..</p>	<p>SVPB(C)(RL) EXT 117°30'</p> <p>VB, VC..</p>	<p>SVVB(C)N EXT 72°30'</p> <p>VB, VC..</p>
<p>SVXB(C)(RL) EXT 98°</p> <p>VB, VC..</p>	<p>C.-SVHB(RL) EXT 107°30'</p> <p>VB, VC..</p>	<p>C.-SVJB(RL) EXT 93°</p> <p>VB, VC..</p>	<p>C.-SVVBN EXT 72°30'</p> <p>VB, VC..</p>

VB

ISO TURNING – INTERNAL – NAVIGATOR

<p>SVJB(RL) INT 93°</p> <p>VB, VC..</p>	<p>SVQB(C)(RL) INT 107°30'</p> <p>VB, VC..</p>	<p>SVUB(C)(RL) INT 93°</p> <p>VB, VC..</p>	<p>C.-SVQB(C)(RL) INT 108°</p> <p>VB, VC..</p>
--	---	---	---

VC

ISO TURNING – EXTERNAL – NAVIGATOR

SVAC(RL)-DC EXT 90°

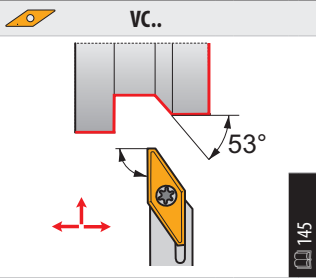

SVJC(RL)-DC EXT 93°

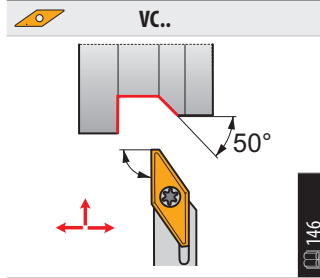

VC

ISO TURNING – INTERNAL – NAVIGATOR

SVLC(RL) INT 95°

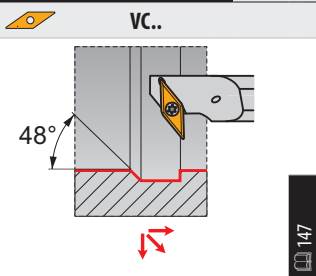

SVJB(RL) INT 93°

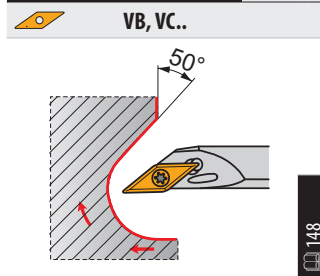

SVXC(RL)-E INT 113°

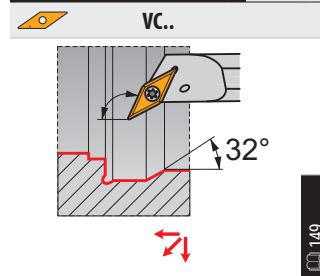

WC

ISO TURNING – EXTERNAL – NAVIGATOR

SWLC(RL) EXT 95°

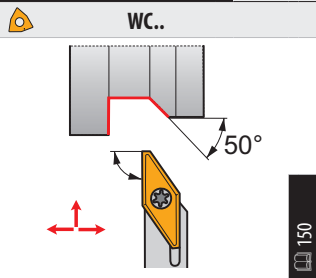

WC

ISO TURNING – INTERNAL – NAVIGATOR

SWLC(RL) INT 95°

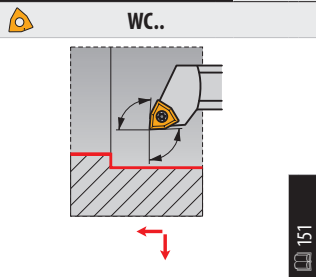

SWUC(RL) INT 93°

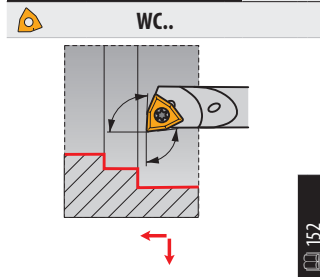

SWUC(RL)-E INT 93°

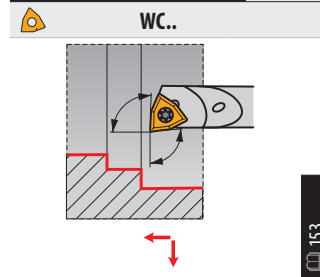

SCAC(RL) EXT



PRAMET

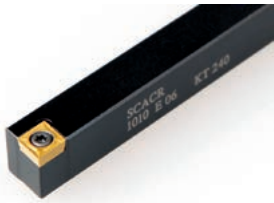

External Screw Lock Tool Holder with 90° Cutting Angle for CC.. Inserts

External Right/Left hand tool holder with 90° cutting angle for screw type positive CC.. inserts. Suited for external longitudinal, taper and chamfer turning, with some usable for sliding head machines. Body treated for longer tool life.

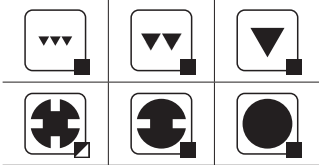
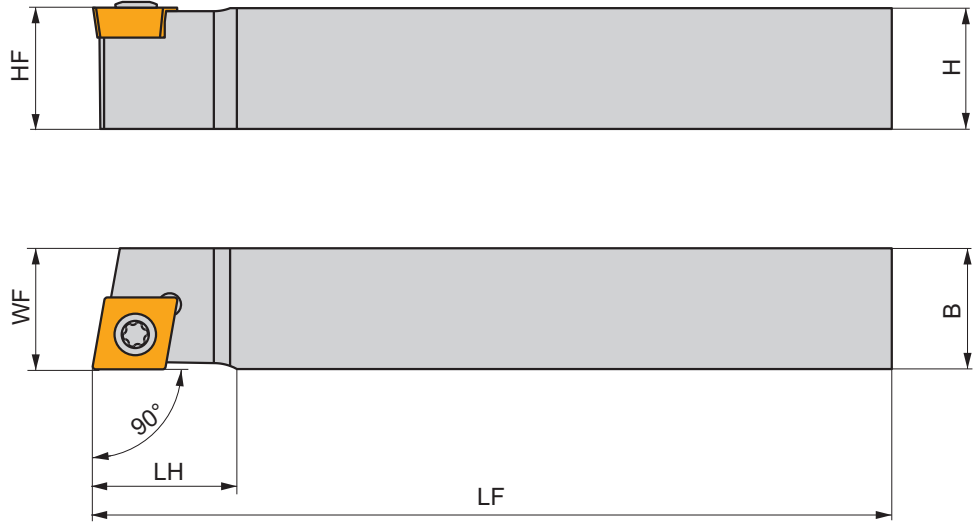
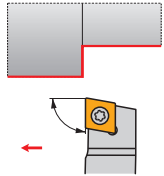

Product	H	B	HF	WF	LF	LH	LAMS	GAMO	kg		
	(mm)	(mm)	(mm)	(mm)	(mm)	(mm)	(°)	(°)			
R	SCACR 0808 D 06	8	8	8	8.5	60	-	0	0.04	GI045	S07
	SCACR 1010 E 06	10	10	10	10.5	70	-	0	0.08	GI045	S07
	SCACR 1212 F 09	12	12	12	12.5	80	-	0	0.11	GI041	S04
	SCACR 1212 K 09-S	12	12	12	12	125	19.0	0	0.14	GI041	S04
	SCACR 1616 H 09	16	16	16	16.5	100	-	0	0.22	GI041	S04
	SCACR 1616 K 09-S	16	16	16	16	125	19.0	0	0.24	GI041	S04
L	SCACL 0808 D 06	8	8	8	8.5	60	-	0	0.05	GI045	S07
	SCACL 1010 E 06	10	10	10	10.5	70	-	0	0.06	GI045	S07
	SCACL 1212 F 09	12	12	12	12.5	80	-	0	0.12	GI041	S04
	SCACL 1212 K 09-S	12	12	12	12	125	19.0	0	0.14	GI041	S04
	SCACL 1616 H 09	16	16	16	16.5	100	-	0	0.22	GI041	S04
	SCACL 1616 K 09-S	16	16	16	16	125	19.0	0	0.24	GI041	S04

GI041	CC.. 09T3..
GI045	CC.. 0602..

S04	US 3510-T15P	3.0	M 3.5	10.6	FLAG T15P
S07	US 2506-T07P	0.9	M 2.5	6.3	FLAG T07P

SCBC(RL) EXT

P
M
K
N
S
H

PRAMET

S



External Screw Lock Tool Holder with 75° Cutting Angle for CC.. Inserts

External Right/Left hand tool holder with 75° cutting angle for screw type positive CC.. inserts. Suited for external longitudinal without shoulder and chamfer turning. Body treated for longer tool life.

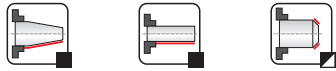
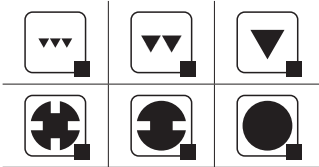
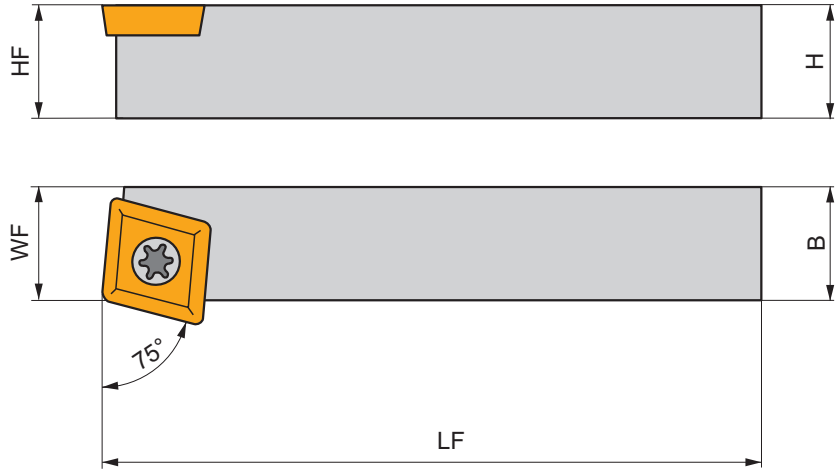
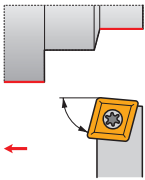

Product	H	B	HF	WF	LF	LAMS	GAMO	kg		
	(mm)	(mm)	(mm)	(mm)	(mm)	(°)	(°)			
R SCBCR 1212 F 09	12	12	12	11	80	0	0	0.10	GI041	S08
SCBCR 1616 H 09	16	16	16	13	100	0	0	0.20	GI041	S08
SCBCR 2020 K 12-M-A	20	20	20	17	125	0	0	0.45	GI011	SC20
SCBCR 2525 M 12-M-A	25	25	25	22	150	0	0	0.61	GI011	SC20
L SCBCL 1212 F 09	12	12	12	11	80	0	0	0.10	GI041	S08
SCBCL 1616 H 09	16	16	16	13	100	0	0	0.22	GI041	S08
SCBCL 2020 K 12-M-A	20	20	20	17	125	0	0	0.43	GI011	SC20
SCBCL 2525 M 12-M-A	25	25	25	22	150	0	0	0.75	GI011	SC20



GI011
GI041

CC.. 1204..
CC.. 09T3..

SC20	US 5012-T15P	5.0	M 5	12.2	SCN 120304	MS 5008	FLAG T15P	HXK 5
S08	US 3510-T15P	3.0	M 3.5	10.6	-	-	FLAG T15P	-

SCDCR EXT

P
M
K
N
S
H

PRAMET

S



External Screw Lock Tool Holder with 45° Cutting Angle for CC.. Inserts

External right hand tool holder with 45° cutting angle for screw type positive CC.. inserts. Suited for external longitudinal without shoulder, taper, multi-directional copy, and chamfer turning. Body treated for longer tool life.

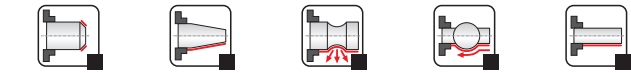
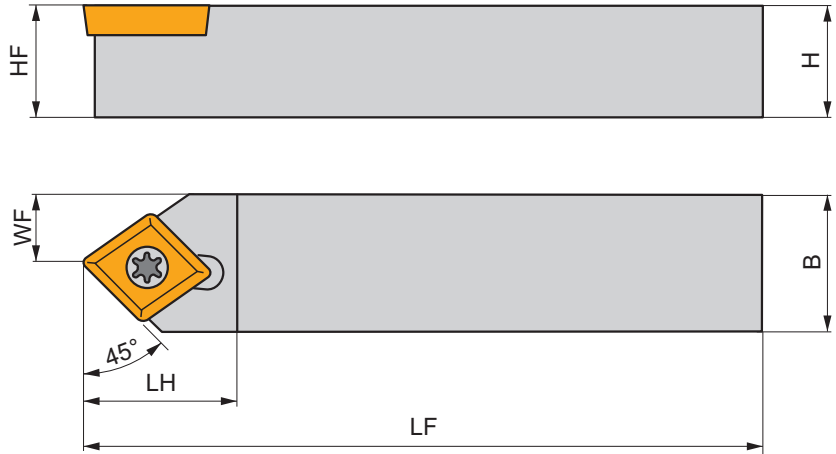
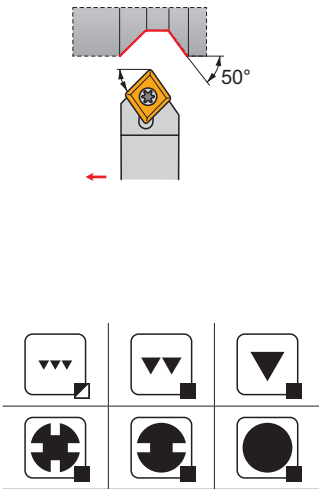

Product	H (mm)	B (mm)	HF (mm)	WF (mm)	LF (mm)	LH (mm)	LAMS (°)	GAMO (°)	kg		
R SCDCR 1010 E 06	10	10	10	5.11	70	11.0	0	0	0.06	G1045	SC21

	G1045		CC.. 0602..
--	-------	--	-------------

	SC21		5513 020-03		0.8		M 2.5		6.5		PT-8001
--	------	--	-------------	--	-----	--	-------	--	-----	--	---------

SCFC(RL) EXT

P
M
K
N
S
H

PRAMET

S

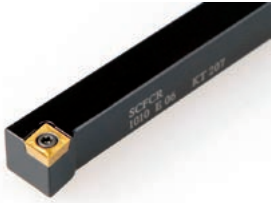

External Screw Lock Tool Holder with 90° Cutting Angle for CC.. Inserts

External Right/Left hand tool holder with 90° cutting angle for screw type positive CC.. inserts. Suited for external face and longitudinal turning with shoulder, taper and chamfer turning. Body treated for longer tool life.

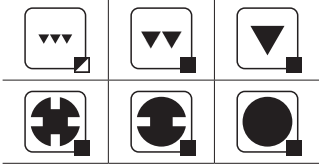
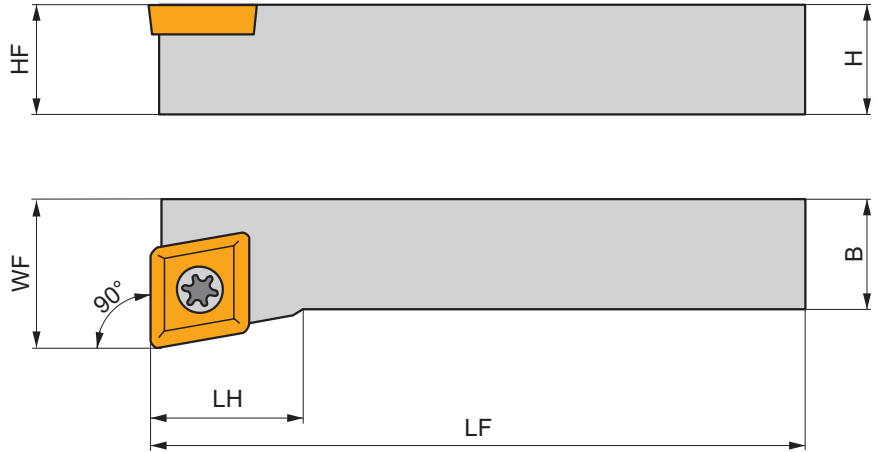
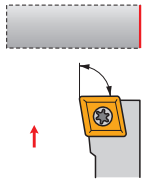

Product	H	B	HF	WF	LF	LH	LAMS	GAMO	kg		
	(mm)	(mm)	(mm)	(mm)	(mm)	(mm)	(°)	(°)			
R SCFCR 0808 D 06	8	8	8	10	60	8.0	0	0	0.04	G1045	S07
SCFCR 1010 E 06	10	10	10	12	70	8.0	0	0	0.07	G1045	S07
SCFCR 1212 F 09	12	12	12	16	80	16.0	0	0	0.12	G1041	S04
SCFCR 1616 H 09	16	16	16	20	100	16.0	0	0	0.22	G1041	S04
L SCFCL 1010 E 06	10	10	10	12	70	8.0	0	0	0.06	G1045	S07
SCFCL 1212 F 09	12	12	12	16	80	16.0	0	0	0.10	G1041	S04
SCFCL 1616 H 09	16	16	16	20	100	16.0	0	0	0.22	G1041	S04

G1041		CC.. 09T3..	
G1045		CC.. 0602..	

S04	US 3510-T15P	3.0	M 3.5	10.6	FLAGT15P
S07	US 2506-T07P	0.9	M 2.5	6.3	FLAGT07P

SCLC(RL) EXT



PRAMET

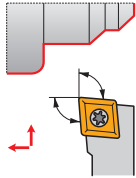

External Screw Lock Tool Holder with 95° Cutting Angle for CC.. Inserts

External Right/Left hand tool holder with 95° cutting angle for screw type positive CC.. inserts. Suited for external longitudinal shoulder, taper and chamfer turning, with some usable for sliding head machines. Body treated for longer tool life.

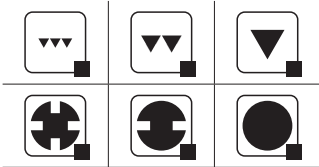
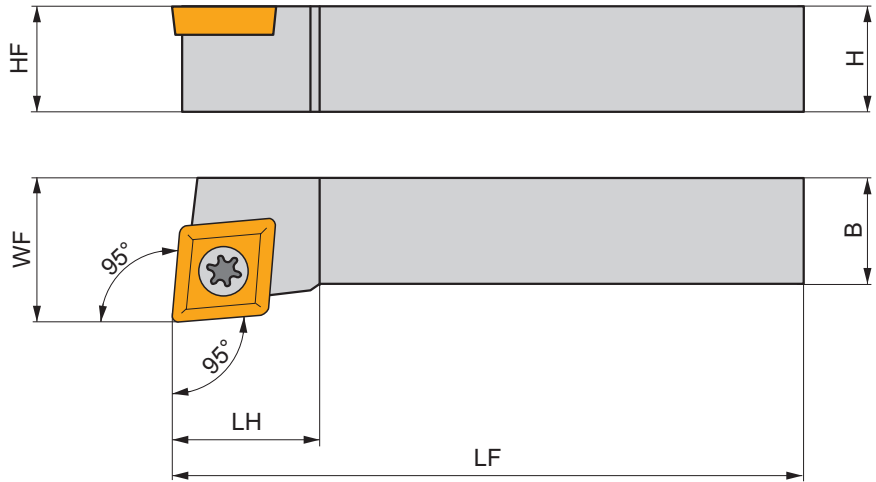









	Product	H	B	HF	WF	LF	LH	LAMS	GAMO	kg		
		(mm)	(mm)	(mm)	(mm)	(mm)	(mm)	(°)	(°)			
R	SCLCR 0808 D 06	8	8	8	10	60	8.0	0	0	0.05	GI045	S01
	SCLCR 1010 E 06	10	10	10	12	70	8.0	0	0	0.09	GI045	S01
	SCLCR 1010 E 08	10	10	10	12	70	13.2	0	0	0.03	GI232	SC22
	SCLCR 1212 F 08	12	12	12	16	80	13.4	0	0	0.01	GI232	SC22
	SCLCR 1212 F 09	12	12	12	16	80	16.0	0	0	0.12	GI041	S08
	SCLCR 1212 K 09-S	12	12	12	12	125	21.3	0	0	0.13	GI041	S08
	SCLCR 1616 H 08	16	16	16	20	100	15.2	0	0	0.22	GI232	SC22
	SCLCR 1616 H 09	16	16	16	20	100	16.0	0	0	0.22	GI041	S08
	SCLCR 1616 K 09-S	16	16	16	16	125	21.3	0	0	0.24	GI041	S08
	SCLCR 2020 K 12-M-A	20	20	20	25	125	20.0	0	0	0.43	GI011	SC20
	SCLCR 2525 M 12-M-A	20	25	20	32	150	20.0	0	0	0.77	GI011	SC20
L	SCLCL 0808 D 06	8	8	8	10	60	8.0	0	0	0.06	GI045	S01
	SCLCL 1010 E 06	10	10	10	12	70	8.0	0	0	0.06	GI045	S01
	SCLCL 1212 F 08	12	12	12	16	80	13.4	0	0	0.03	GI232	SC22
	SCLCL 1212 F 09	12	12	12	16	80	16.0	0	0	0.10	GI041	S08
	SCLCL 1212 K 09-S	12	12	12	12	125	21.3	0	0	0.13	GI041	S08
	SCLCL 1616 H 08	16	16	16	20	100	15.2	0	0	0.23	GI232	SC22
	SCLCL 1616 H 09	16	16	16	20	100	16.0	0	0	0.22	GI041	S08
	SCLCL 1616 K 09-S	16	16	16	16	125	21.3	0	0	0.24	GI041	S08
	SCLCL 2020 K 12-M-A	20	20	20	25	125	20.0	0	0	0.40	GI011	SC20
	SCLCL 2525 M 12-M-A	25	25	25	32	150	20.0	0	0	0.77	GI011	SC20

GI011	CC.. 1204..
GI041	CC.. 09T3..
GI045	CC.. 0602..



GI232 CC.. 0803..

								
SC20	US 5012-T15P	5.0	M 5	12.2	SCN 120304	MS 5008	FLAG T15P	HXK 5
SC22	5513 020-04	1.5	M 3	7.2	-	-	PT-8003	-
S01	US 2506-T07P	0.9	M 2.5	6.3	-	-	FLAG T07P	-
S08	US 3510-T15P	3.0	M 3.5	10.6	-	-	FLAG T15P	-

C.-SCLC(RL) EXT

P
M
K
N
S
H

PRAMET

S



External PSC Quick Change Tool, Screw Lock, 95° Cutting Angle for CC.. Inserts

External Right/Left hand tool, through coolant, with 95° cutting angle for screw type positive CC.. inserts. Suited for external longitudinal turning with shoulder, taper and chamfer turning. Polygon Shank Coupling. Body treated for longer tool life.

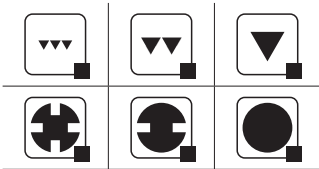
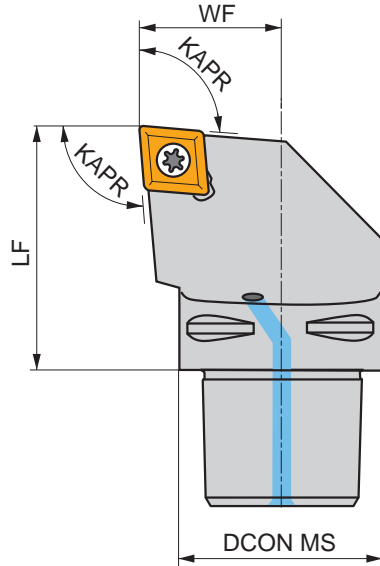
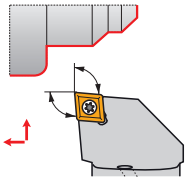

Product	DCON MS	WF	LF	KAPR	LAMS	GAMO				
	(mm)	(mm)	(mm)	(°)	(°)	(°)				
R C3-SCLCR-22040-09	32	22	40	95	0	0	✓	0.21	GI041	C-SC09S
C4-SCLCR-27050-09	40	27	50	95	0	0	✓	0.39	GI041	C-SC09S
C4-SCLCR-27050-12	40	27	50	95	0	0	✓	0.40	GI011	C-SC12-1
C5-SCLCR-35060-12	50	35	60	95	0	0	✓	0.72	GI011	C-SC12-2
L C3-SCLCL-22040-09	32	22	40	95	0	0	✓	0.21	GI041	C-SC09S
C4-SCLCL-27050-09	40	27	50	95	0	0	✓	0.39	GI041	C-SC09S
C5-SCLCL-35060-12	50	35	60	95	0	0	✓	0.72	GI011	C-SC12-2

GI011	CC.. 1204..
GI041	CC.. 09T3..

C-SC09S	US 2001-T15P	3.0	M 3.5	12.1	SCS 232-01	MS 9001	FLAG T15P/3,5	CN 034-01	
C-SC12-1	US 2018-T15P	3.0	M 4	14	SCS 232-02	MS 9003	FLAG T15P/4	CN 034-01	
C-SC12-2	US 2018-T15P	3.0	M 4	14	SCS 232-02	MS 9003	FLAG T15P/4	CN 034-02	

SCFC(RL) INT

P
M
K
N
S
H

PRAMET

S



Internal Screw Lock Boring Bar with 90° Cutting Angle for CC.. Inserts

Internal Right/Left hand boring bar with 90° cutting angle for screw type CC.. inserts. Suited for internal face and longitudinal turning with shoulder, taper and chamfer turning. Body treated for longer tool life.

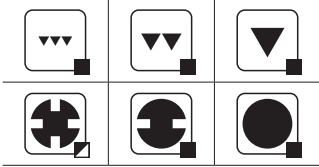
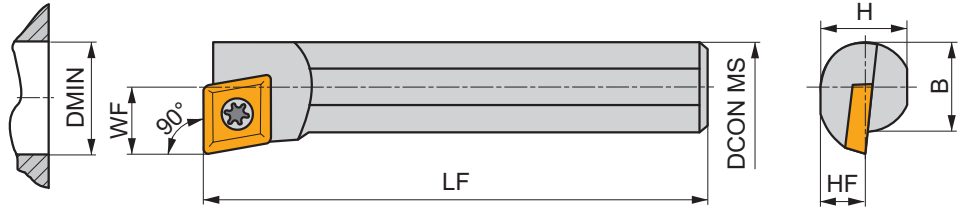
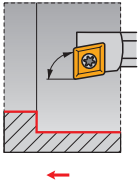

Product	DCON MS	DMIN	WF	H	B	LF	LAMS	GAMO	kg		
	(mm)	(mm)	(mm)	(mm)	(mm)	(mm)	(°)	(°)			
R S10H-SCFCR 06	10	13	7	9	9.5	100	-10	0	0.08	G1045	S06
	S12K-SCFCR 06	12	16	9	11	11.5	-7	0	0.11	G1045	S06
L S10H-SCFCL 06	10	13	7	9	9.5	100	-10	0	0.08	G1045	S06
	S12K-SCFCL 06	12	16	9	11	11.5	-7	0	0.13	G1045	S06

G1045	CC.. 0602..

S06	US 2505-T07P	0.9	M 2.5	5.2	FLAG T07P

SCKC(RL) INT



PRAMET



Internal Screw Lock Boring Bar with 75° Cutting Angle for CC.. Inserts

Internal Right/Left hand boring bar with 75° cutting angle for screw type CC.. inserts. Suited for internal longitudinal turning without shoulder, taper and chamfer turning. Body treated for longer tool life.

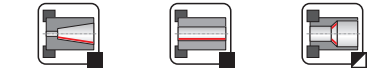
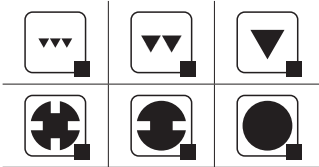
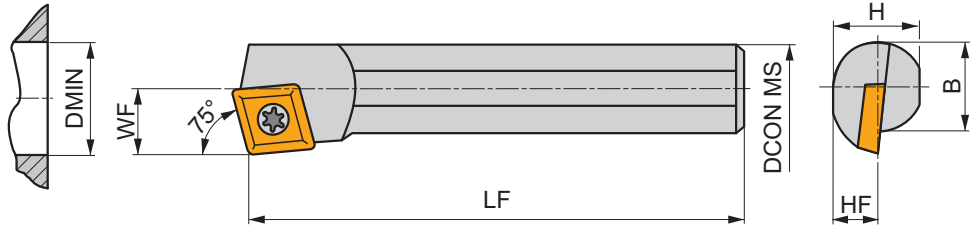
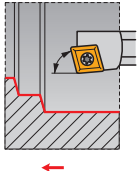

Product	DCON MS	DMIN	WF	H	B	LF	LAMS	GAMO	kg	G1045	S02
	(mm)	(mm)	(mm)	(mm)	(mm)	(mm)	(°)	(°)			
R S08F-SCKCR 06	8	11	6	7.2	7.6	80	-12	0	0.03	G1045	S02
S12K-SCKCR 06	12	16	9	11	11.5	125	-8	0	0.11	G1045	S02
S16M-SCKCR 09-A	16	20	11	14.5	15	150	-8	0	0.25	G1041	S05
S20S-SCKCR 09	20	25	13	18.5	18.5	250	-5	0	0.60	G1041	S08
S25T-SCKCR 09	25	32	17	23	23	300	-3	0	1.15	G1041	S08
S32U-SCKCR 12-A	32	40	22	30	30	350	-10	0	2.10	G1011	SC20
L S20S-SCKCL 09	20	25	13	18.5	18.5	250	-5	0	0.60	G1041	S08

G1011		CC.. 1204..
G1041		CC.. 09T3..
G1045		CC.. 0602..

		Nm						
SC20	US 5012-T15P	5.0	M 5	12.2	SCN 120304	MS 5008	FLAG T15P	HXK 5
S02	US 2505-T07P	0.9	M 2.5	5.2	-	-	FLAG T07P	-
S05	US 4008-T15P	3.5	M 4	8	-	-	FLAG T15P	-
S08	US 3510-T15P	3.0	M 3.5	10.6	-	-	FLAG T15P	-

SCLC(RL) INT

P
M
K
N
S
H

PRAMET

S



Internal Screw Lock Boring Bar with 95° Cutting Angle for CC.. Inserts

Internal Right/Left hand boring bar, through coolant available, 95° cutting angle for screw type CC.. inserts. For internal longitudinal turning with shoulder, taper and chamfer turning. Body treated for longer tool life.

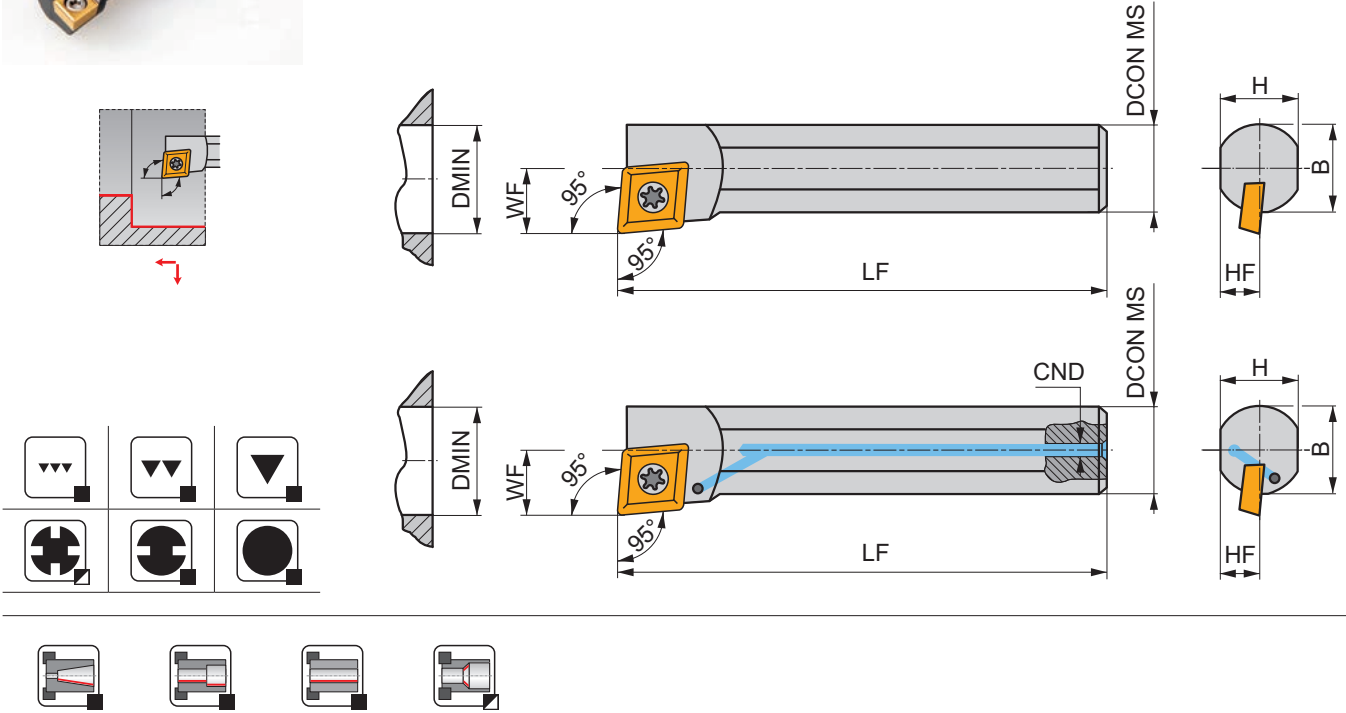

Product	DCON MS	DMIN	WF	H	B	LF	CND	LAMS	GAMO				
	(mm)	(mm)	(mm)	(mm)	(mm)	(mm)	(mm)	(°)	(°)				
R A08H-SCLCR 06	8	11	6	7.2	7.6	100	3.5	-13	0	✓	0.03	G1045	S02
S08F-SCLCR 06	8	11	6	7.2	7.6	80	-	-13	0	-	0.05	G1045	S02
A10H-SCLCR 06	10	13	7	9	-	100	4	-10	0	✓	0.07	G1045	S02
S10H-SCLCR 06	10	13	7	9	9.5	100	-	-10	0	-	0.07	G1045	S02
A12K-SCLCR 06	12	16	9	11	-	125	5	-8	0	✓	0.09	G1045	S01
S12K-SCLCR 06	12	16	9	11	11.5	125	-	-8	0	-	0.12	G1045	S01
S16M-SCLCR 06	16	20	11	14.5	15	150	-	-8	0	-	0.25	G1045	S01
A10K-SCLCR 08	10	12	6	9	9.5	125	4	-14	0	✓	0.09	G1232	SC22
A12M-SCLCR 08	12	16	9	11	11.5	150	5	-5	0	✓	0.14	G1232	SC22
A16R-SCLCR 08	16	20	11	14	15	200	6	-8	0	✓	0.28	G1232	SC22
A16M-SCLCR 09-A	16	20	11	14.5	-	150	6	-8	0	✓	0.22	G1041	S05
S16M-SCLCR 09-A	16	20	11	14.5	15	150	-	-8	0	-	0.25	G1041	S05
A20Q-SCLCR 09	20	25	13	18	-	180	8	-5	0	✓	0.37	G1041	S08
S20S-SCLCR 09	20	25	13	18	18.5	250	-	-5	0	-	0.59	G1041	S08
A25R-SCLCR 09	25	32	17	23	23	200	8	-3	0	✓	0.60	G1041	S08
S25T-SCLCR 09	25	32	17	23	23	300	-	-3	0	-	1.08	G1041	S08
A32S-SCLCR 12-A	32	40	22	30	30	250	8	-10	0	✓	1.35	G1011	SC20
S32U-SCLCR 12-A	32	40	22	30	30	350	-	-10	0	-	2.10	G1011	SC20
L A08H-SCLCL 06	8	11	6	7.2	7.6	100	-	-13	0	✓	0.05	G1045	S02
S08F-SCLCL 06	8	11	6	7.2	7.6	80	-	-13	0	-	0.05	G1045	S02
A10H-SCLCL 06	10	13	7	9	-	100	4	-10	0	✓	0.06	G1045	S02
S10H-SCLCL 06	10	13	7	9	9.5	100	-	-10	0	-	0.06	G1045	S02
A12K-SCLCL 06	12	16	9	11	-	125	5	-8	0	✓	0.10	G1045	S01
S12K-SCLCL 06	12	16	9	11	11.5	125	-	-8	0	-	0.11	G1045	S01
S16M-SCLCL 06	16	20	11	14.5	15	150	-	-8	0	-	0.24	G1045	S01
A10K-SCLCL 08	10	12	6	9	9.5	125	4	-14	0	✓	0.00	G1232	SC22
A12M-SCLCL 08	12	16	9	11	11.5	150	5	-5	0	✓	0.14	G1232	SC22

Product	D CON MS	D MIN	W F	H	B	L F	C ND	L AMS	G AMO				
	(mm)	(mm)	(mm)	(mm)	(mm)	(mm)	(mm)	(°)	(°)				
A16R-SCLCL 08	16	20	11	14	15	200	6	-8	0	✓	0.30	GI232	SC22
A16M-SCLCL 09-A	16	20	11	14.5	–	150	6	-8	0	✓	0.22	GI041	S05
S16M-SCLCL 09-A	16	20	11	14.5	15	150	–	-8	0	–	0.24	GI041	S05
A20Q-SCLCL 09	20	25	13	18	–	180	8	-5	0	✓	0.37	GI041	S08
S20S-SCLCL 09	20	25	13	18	18.5	250	–	-5	0	–	0.60	GI041	S08
A25R-SCLCL 09	25	32	17	23	23	200	8	-3	0	✓	0.67	GI041	S08
S25T-SCLCL 09	25	32	17	23	23	300	–	-3	0	–	1.08	GI041	S08
A32S-SCLCL 12-A	32	40	22	30	30	250	8	-10	0	✓	1.35	GI011	SC20
S32U-SCLCL 12-A	32	40	22	30	30	350	–	-10	0	–	2.00	GI011	SC20

GI011	CC.. 1204..
GI041	CC.. 09T3..
GI045	CC.. 0602..
GI232	CC.. 0803..

SC20	US 5012-T15P	5.0	M 5	12.2	SCN 120304	MS 5008	FLAG T15P	HXX 5	
SC22	5513 020-04	1.5	M 3	7.2	–	–	PT-8003	–	
S01	US 2506-T07P	0.9	M 2.5	6.3	–	–	FLAG T07P	–	
S02	US 2505-T07P	0.9	M 2.5	5.2	–	–	FLAG T07P	–	
S05	US 4008-T15P	3.5	M 4	8	–	–	FLAG T15P	–	
S08	US 3510-T15P	3.0	M 3.5	10.6	–	–	FLAG T15P	–	

SCXC(RL) INT

P
M
K
N
S
H

PRAMET

S



Internal Screw Lock Boring Bar with 40° Cutting Angle for CC.. Inserts

Internal Right/Left hand boring bar, 40° cutting angle for screw type CC.. inserts. Suited for internal front and back chamfering, longitudinal turning without shoulder and taper turning. Body treated for longer tool life.

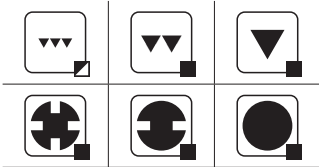
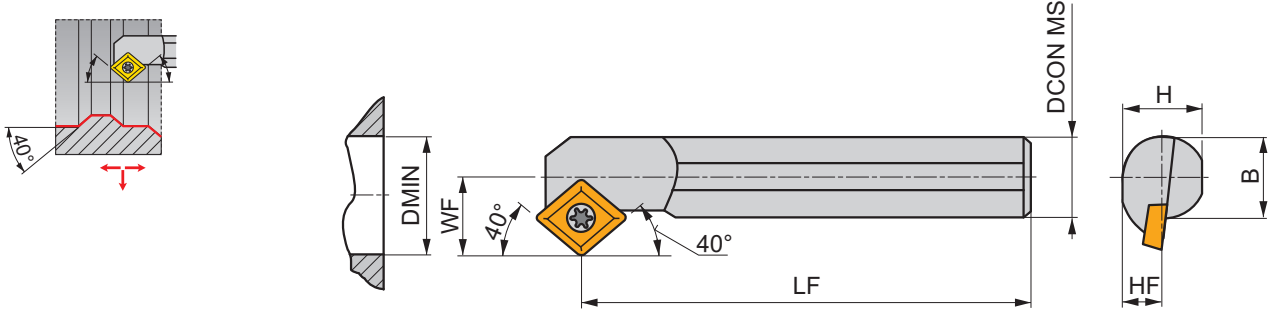

Product	DCON MS	DMIN	WF	H	B	LF	LAMS	GAMO	kg	G1045	S06/S07
	(mm)	(mm)	(mm)	(mm)	(mm)	(mm)	(°)	(°)			
R S10H-SCXCR 06	10	13	7	9	9.5	100	-10	0	0.06	G1045	S06
S12K-SCXCR 06	12	16	9	11	11.5	125	-8	0	0.11	G1045	S06
S16Q-SCXCR 06	16	20	11	14.5	15	180	-7	0	0.29	G1045	S07
L S10H-SCXCL 06	10	13	7	9	9.5	100	-10	0	0.06	G1045	S06
S12K-SCXCL 06	12	16	9	11	11.5	125	-8	0	0.11	G1045	S06
S16Q-SCXCL 06	16	20	11	14.5	15	180	-7	0	0.30	G1045	S07

G1045	CC.. 0602..

S06	US 2505-T07P	0.9	M 2.5	5.2	FLAG T07P
S07	US 2506-T07P	0.9	M 2.5	6.3	FLAG T07P

C.-SCLC(RL) INT

P
M
K
N
S
H

PRAMET

S



Internal PSC Quick Change Tool, Screw Lock, 95° Cutting Angle for CC.. Inserts

Internal Right/Left hand tool, through coolant, with 95° cutting angle for screw type CC.. inserts. Suited for a wide range of internal turning applications. Polygon Shank Coupling with choice of lengths. Body treated for longer tool life.

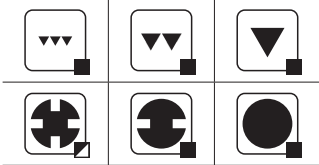
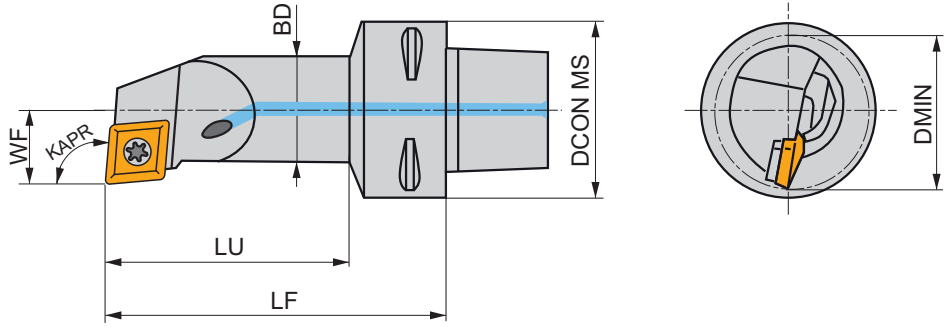
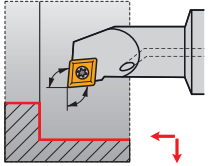

Product	DCON MS	DMIN	WF	LF	LU	BD	KAPR	LAMS	GAMO					
	(mm)	(mm)	(mm)	(mm)	(mm)	(mm)	(°)	(°)	(°)					
R	C3-SCLCR-11065-09	32	20	11	65	48	16	95	-8.4	0	✓	0.21	GI041	SC09M
	C3-SCLCR-13075-09	32	25	13	75	58	20	95	-5.8	0	✓	0.26	GI041	SC09M
	C4-SCLCR-11070-09	40	20	11	70	47	16	95	-8.4	0	✓	0.36	GI041	SC09M
	C4-SCLCR-13080-09	40	25	13	80	57	20	95	-5.8	0	✓	0.41	GI041	SC09M
	C4-SCLCR-17090-09	40	32	17	90	68	25	95	-3.4	0	✓	0.50	GI041	SC09M
L	C5-SCLCR-11070-09	50	20	11	70	46	16	95	-8.4	0	✓	0.55	GI041	SC09M
	C5-SCLCR-13080-09	50	25	13	80	56	20	95	-5.8	0	✓	0.60	GI041	SC09M
	C4-SCLCL-11070-09	40	20	11	70	47	16	95	-8.4	0	✓	0.36	GI041	SC09M
	C4-SCLCL-13080-09	40	25	13	80	57	20	95	-5.8	0	✓	0.41	GI041	SC09M
	C5-SCLCL-11070-09	50	20	11	70	46	16	95	-8.4	0	✓	0.55	GI041	SC09M
C5-SCLCL-13080-09	50	25	13	80	56	20	95	-5.8	0	✓	0.60	GI041	SC09M	

GI041
 CC.. 09T3..

SC09M
 US 2009-T15P
 3.0
 M 3.5
 8.1
 FLAG T15P/3,5

SDFC(RL) EXT

P
M
K
N
S
H

PRAMET

S



External Screw Lock Tool Holder with 91° Cutting Angle for DC.. Inserts

External Right/Left hand tool holder with 91° cutting angle for screw type positive DC.. inserts. Suited for external longitudinal shoulder, copy, face, taper and chamfer turning. and usable for sliding head machines. Body treated for longer tool life.

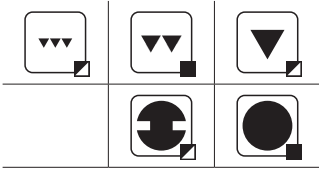
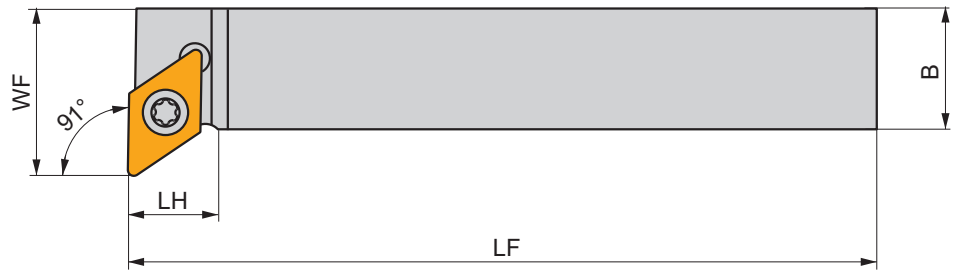
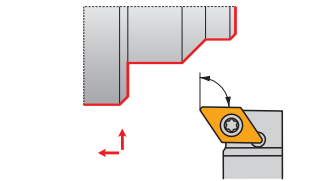

Product	H (mm)	B (mm)	HF (mm)	WF (mm)	LF (mm)	LH (mm)	LAMS (°)	GAMO (°)	kg	GI	SO
R SDFCR 1212 K 07-S	12	12	12	16	125	8.8	0	0	0.14	GI052	S01
SDFCR 1616 K 11-S	16	16	16	22	125	11.9	0	0	0.25	GI012	S08
L SDFCL 1212 K 07-S	12	12	12	16	125	8.8	0	0	0.14	GI052	S01
SDFCL 1616 K 11-S	16	16	16	22	125	11.9	0	0	0.25	GI012	S08

GI	SO	DC..
GI012		DC.. 11T3..
GI052		DC.. 0702..

SO	US	Nm	M	mm	FLAG
S01	US 2506-T07P	0.9	M 2.5	6.3	FLAG T07P
S08	US 3510-T15P	3.0	M 3.5	10.6	FLAG T15P

SDJC(RL) EXT



PRAMET







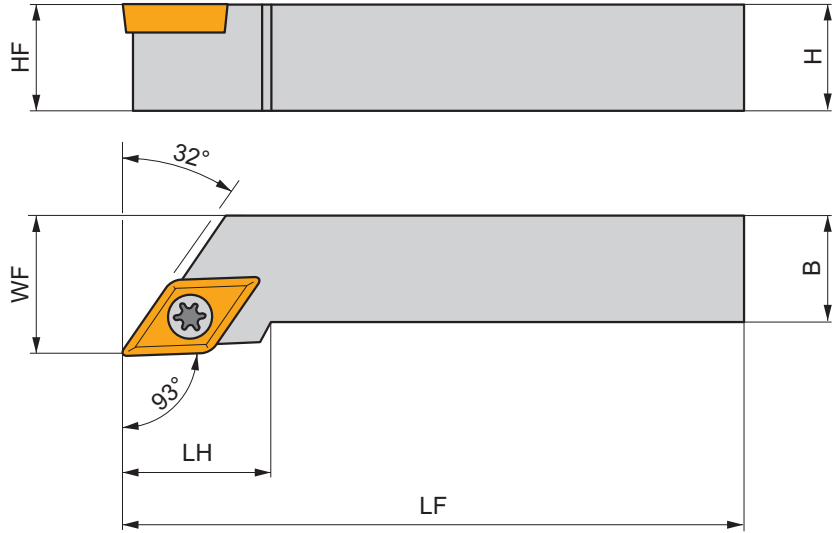
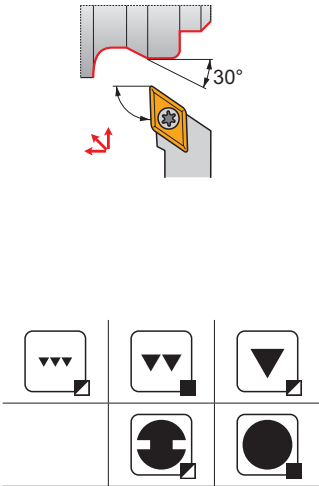



External Screw Lock Tool Holder with 93° Cutting Angle for DC.. Inserts

External Right/Left hand tool holder with 93° cutting angle for screw type positive DC.. inserts. Suited for external longitudinal shoulder, copy, taper and chamfer turning. with some usable for sliding head machines. Body treated for longer tool life.



	Product	H	B	HF	WF	LF	LH	LAMS	GAMO	kg	G1012	G1052	G1243
		(mm)	(mm)	(mm)	(mm)	(mm)	(mm)	(°)	(°)				
R	SDJCR 0808 D 07	8	8	8	10	60	14.0	0	0	0.05	G1052	S01	
	SDJCR 1010 E 07	10	10	10	12	70	14.0	0	0	0.06	G1052	S01	
	SDJCR 1212 F 07	12	12	12	16	80	14.0	0	0	0.11	G1052	S01	
	SDJCR 1212 F 11	12	12	12	16	80	20.0	0	0	0.10	G1012	S08	
	SDJCR 1212 K 07-S	12	12	12	12	125	18.2	0	0	0.13	G1052	S01	
	SDJCR 1212 K 11-S	12	12	12	12	125	22.6	0	0	0.13	G1012	S08	
	SDJCR 1616 H 11	16	16	16	20	100	20.0	0	0	0.22	G1012	S08	
	SDJCR 1616 K 11-S	16	16	16	16	125	22.6	0	0	0.23	G1012	S08	
	SDJCR 2020 K 11-M-A	20	20	20	25	125	20.0	0	0	0.40	G1012	SD10	
	SDJCR 2525 M 11-M-A	25	25	25	32	150	20.0	0	0	0.74	G1012	SD10	
	SDJCR 2525 M 15	25	25	25	32	150	28.0	0	0	0.74	G1243	SD11	
	L	SDJCL 0808 D 07	8	8	8	10	60	14.0	0	0	0.04	G1052	S01
SDJCL 1010 E 07		10	10	10	12	70	14.0	0	0	0.07	G1052	S01	
SDJCL 1212 F 07		12	12	12	16	80	14.0	0	0	0.11	G1052	S01	
SDJCL 1212 F 11		12	12	12	16	80	20.0	0	0	0.11	G1012	S08	
SDJCL 1212 K 07-S		12	12	12	12	125	18.2	0	0	0.13	G1052	S01	
SDJCL 1212 K 11-S		12	12	12	12	125	22.6	0	0	0.13	G1012	S08	
SDJCL 1616 H 11		16	16	16	20	100	20.0	0	0	0.20	G1012	S08	
SDJCL 1616 K 11-S		16	16	16	16	125	22.6	0	0	0.23	G1012	S08	
SDJCL 2020 K 11-M-A		20	20	20	25	125	20.0	0	0	0.41	G1012	SD10	
SDJCL 2525 M 11-M-A		25	25	25	32	150	20.0	0	0	0.74	G1012	SD10	
SDJCL 2525 M 15		25	25	25	32	150	28.0	0	0	0.07	G1243	SD11	

G1012		DC.. 11T3..
G1052		DC.. 0702..
G1243		DC.. 1504..

								
SD10	US 3510-T15P	3.0	M 3.5	10.6	SDN 110304	MS 3510	FLAG T15P	HXK 3.5
SD11	US 64518-T15P	5.0	M 4.5	18	SDN 150304	MS 4512	FLAG T15P	HXK 5
S01	US 2506-T07P	0.9	M 2.5	6.3	–	–	FLAG T07P	–
S08	US 3510-T15P	3.0	M 3.5	10.6	–	–	FLAG T15P	–

SDNCN EXT

P
M
K
N
S
H

PRAMET

S



External Screw Lock Tool Holder with 62.5° Cutting Angle for DC.. Inserts

External neutral tool holder with 62.5° cutting angle for screw type positive DC.. inserts. Suited for external longitudinal turning without shoulder, copy, taper and chamfer turning. Body treated for longer tool life.

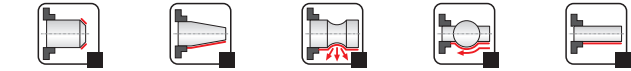
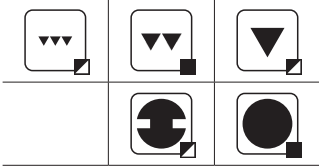
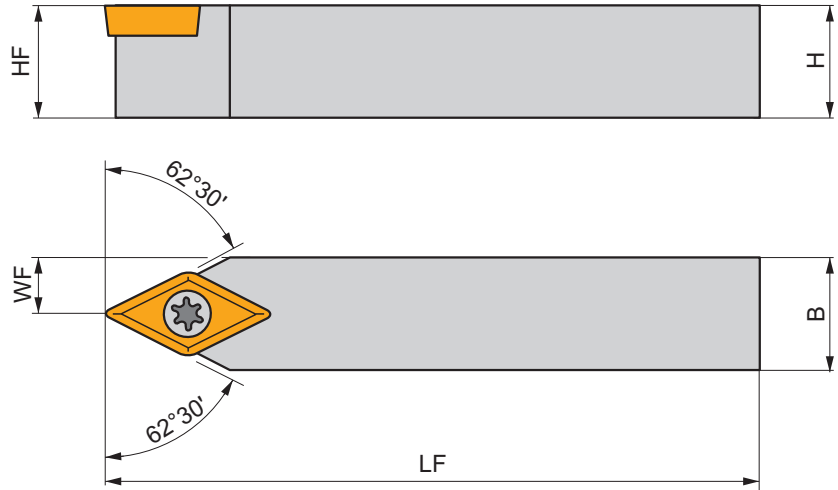
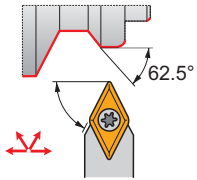

Product	H	B	HF	WF	LF	LAMS	GAMO	kg		
	(mm)	(mm)	(mm)	(mm)	(mm)	(°)	(°)			
N SDNCN 0808 D 07	8	8	8	4	60	0	0	0.05	GI052	S01
SDNCN 1010 E 07	10	10	10	5	70	0	0	0.07	GI052	S01
SDNCN 1212 F 07	12	12	12	6	80	0	0	0.11	GI052	S01
SDNCN 1212 F 11	12	12	12	6	80	0	0	0.11	GI012	S08
SDNCN 1616 H 11	16	16	16	8	100	0	0	0.20	GI012	S08
SDNCN 2020 K 11-M-A	20	20	20	10	125	0	0	0.35	GI012	SD10
SDNCN 2525 M 11-M-A	25	25	25	12.5	150	0	0	0.70	GI012	SD10

GI012	DC.. 11T3..
GI052	DC.. 0702..

SD10	US 3510-T15P	3.0	M 3.5	10.6	SDN 110304	MS 3510	FLAG T15P	HXK 3.5
S01	US 2506-T07P	0.9	M 2.5	6.3	-	-	FLAG T07P	-
S08	US 3510-T15P	3.0	M 3.5	10.6	-	-	FLAG T15P	-

SDUCL EXT



PRAMET

S



External Screw Lock Tool Holder with 93° Cutting Angle for DC.. Inserts

External Right/Left hand tool holder with 93° cutting angle for screw type positive DC.. inserts. Suited for external longitudinal shoulder, copy, face turning, taper and chamfer turning. and usable for sliding head machines. Body treated for longer tool life.

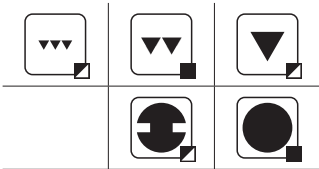
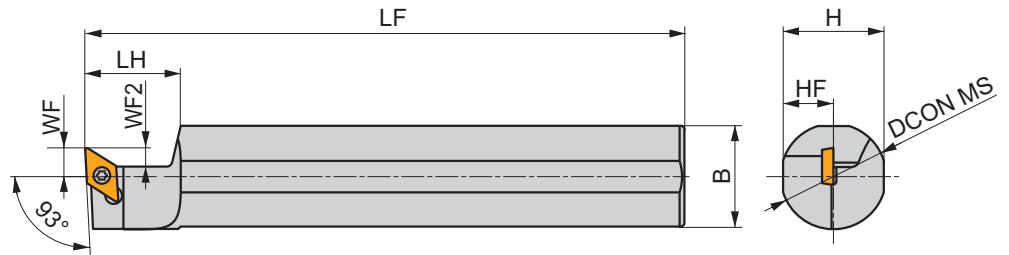
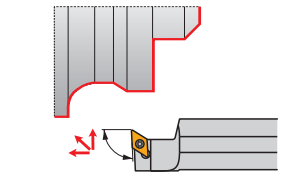

Product	DCON MS	H	B	HF	WF	LF	LH	WF2	LAMS	GAMO	kg		
	(mm)	(mm)	(mm)	(mm)	(mm)	(mm)	(mm)	(mm)	(°)	(°)			
L S20K-SDUCL07-S	20	19	19	9.5	6	125	18.0	4	0	0	0.23	G1052	S01
	S22K-SDUCL07-S	22	21	21	10.5	6	125	18.0	4	0	0.27	G1052	S01

	G1052		DC.. 0702..
--	-------	--	-------------

	S01		US 2506-T07P		0.9		M 2.5		6.3		FLAG T07P
--	-----	--	--------------	--	-----	--	-------	--	-----	--	-----------

SDXC(RL) EXT

P
M
K
N
S
H

PRAMET

S



External Screw Lock Tool Holder with 62.5° Cutting Angle for DC.. Inserts

External Right/Left hand tool holder with 62.5° cutting angle for screw type positive DC.. inserts. Suited for external longitudinal shoulder, copy, taper and chamfer turning. and usable for sliding head machines. Body treated for longer tool life.

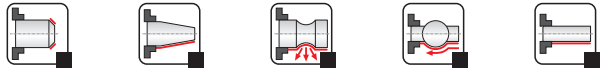
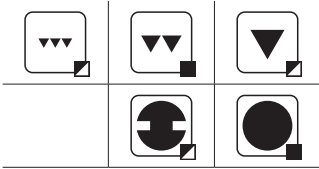
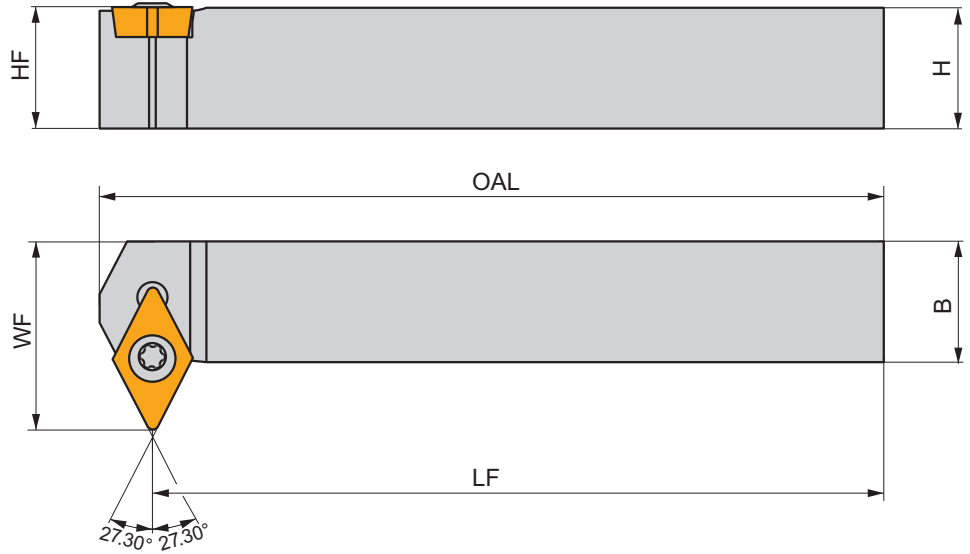
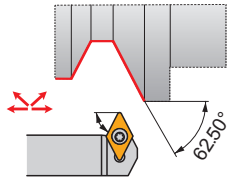

Product	H (mm)	B (mm)	HF (mm)	WF (mm)	LF (mm)	OAL (mm)	LAMS (°)	GAMO (°)	kg	GI052	S01
R SDXCR 1212 K 07-S	12	12	12	18	125	130	0	0	0.15	GI052	S01
SDXCR 1616 K 11-S	16	16	16	25	125	132	0	0	0.26	GI012	S08
L SDXCL 1212 K 07-S	12	12	12	18	125	130	0	0	0.15	GI052	S01
SDXCL 1616 K 11-S	16	16	16	25	125	132	0	0	0.26	GI012	S08

GI012	GI052	DC.. 11T3..	DC.. 0702..

S01	US 2506-T07P	0.9	M 2.5	6.3	FLAG T07P
S08	US 3510-T15P	3.0	M 3.5	10.6	FLAG T15P

C.-SDJC(RL) EXT

P
M
K
N
S
H

PRAMET

S



External PSC Quick Change Tool, Screw Lock, 93° Cutting Angle for DC.. Inserts

External Right/Left hand tool, through coolant, with 93° cutting angle for screw type positive DC.. inserts. Suited for external longitudinal turning with shoulder, copy, taper and chamfer turning. Polygon Shank Coupling. Body treated for longer tool life.

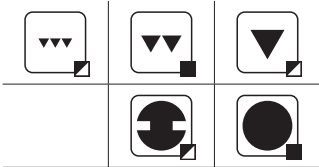
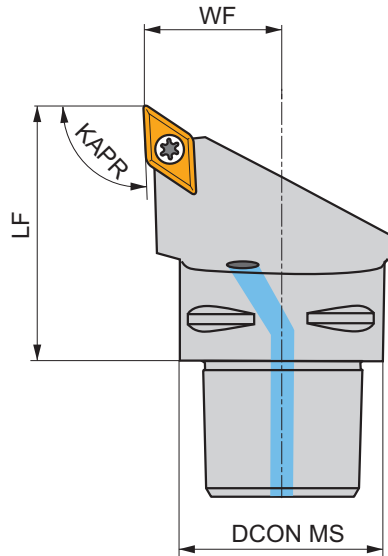
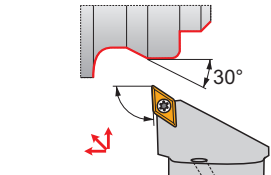

Product	DCON MS	WF	LF	KAPR	LAMS	GAMO				
	(mm)	(mm)	(mm)	(°)	(°)	(°)				
R C3-SDJCR-22040-11	32	22	40	93	0	0	✓	0.20	GI012	C-SD11V-1
C4-SDJCR-27050-11	40	27	50	93	0	0	✓	0.38	GI012	C-SD11V-1
C5-SDJCR-35060-11	50	35	60	93	0	0	✓	0.69	GI012	C-SD11V-2
L C3-SDJCL-22040-11	32	22	40	93	0	0	✓	0.20	GI012	C-SD11V-1
C4-SDJCL-27050-11	40	27	50	93	0	0	✓	0.38	GI012	C-SD11V-1
C5-SDJCL-35060-11	50	35	60	93	0	0	✓	0.70	GI012	C-SD11V-2

GI012	DC.. 11T3..

C-SD11V-1	US 2001-T15P	3.0	M 3.5	12.1	SDS 263-01	MS 9001	FLAG T15P/3,5	CN 034-01
C-SD11V-2	US 2001-T15P	3.0	M 3.5	12.1	SDS 263-01	MS 9001	FLAG T15P/3,5	CN 034-02

C.-SDNCN EXT

P
M
K
N
S
H

PRAMET

S



External PSC Quick Change Tool, Screw Lock, 62.5° Cutting Angle, DC.. Inserts

External Right/Left hand tool, through coolant, with 62.5° cutting angle for screw type positive DC.. inserts. Suited for external longitudinal turning without shoulder, copy, taper and chamfer turning. Polygon Shank Coupling. Body treated for longer tool life.

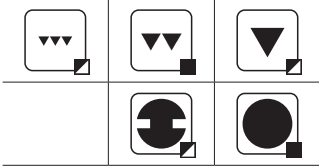
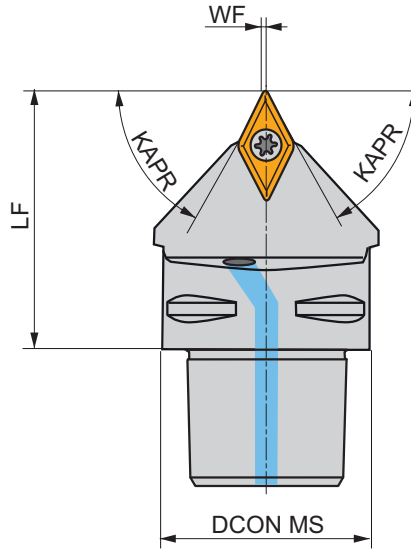
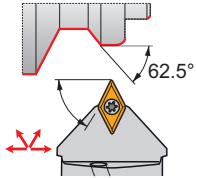

Product	DCON MS (mm)	WF (mm)	LF (mm)	KAPR (°)	LAMS (°)	GAMO (°)		kg		
N C4-SDNCN-00050-11	40	0.5	50	62.5	0	0	✓	0.35	GI012	C-SD11V-1
C5-SDNCN-00060-11	50	0.5	60	62.5	0	0	✓	0.62	GI012	C-SD11V-2

GI012	DC.. 11T3..

C-SD11V-1	US 2001-T15P	3.0	M 3.5	12.1	SDS 263-01	MS 9001	FLAG T15P/3,5	CN 034-01
C-SD11V-2	US 2001-T15P	3.0	M 3.5	12.1	SDS 263-01	MS 9001	FLAG T15P/3,5	CN 034-02

SDQC(RL) INT

P
M
K
N
S
H

PRAMET

S



Internal Screw Lock Boring Bar with 107.5° Cutting Angle for DC.. Inserts

Internal Right/Left hand boring bar, through coolant available, 107.5° cutting angle for screw type DC.. inserts. For internal longitudinal turning with shoulder, taper, copying and chamfer turning. Body treated for longer tool life.

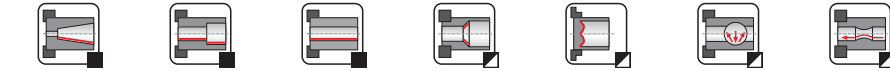
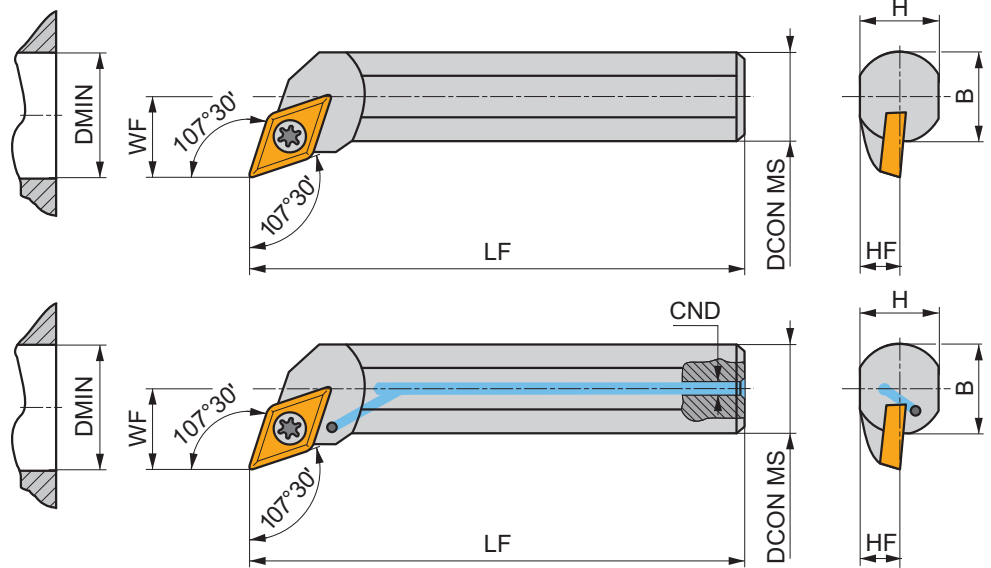
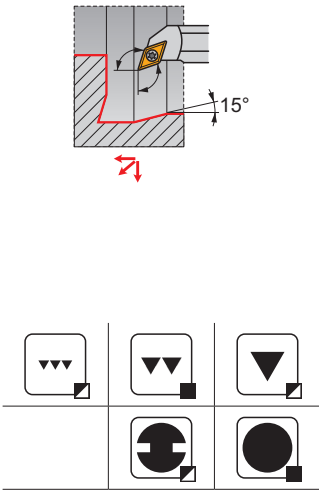

	Product	DCON MS	DMIN	WF	H	B	LF	CND	LAMS	GAMO				
		(mm)	(mm)	(mm)	(mm)	(mm)	(mm)	(mm)	(°)	(°)				
R	A10H-SDQCR 07	10	13	7	9	-	100	4	-10	0	✓	0.07	G1052	S02
	A12K-SDQCR 07	12	16	9	11	-	125	5	-7	0	✓	0.10	G1052	S02
	A16M-SDQCR 07	16	20	11	14.5	-	150	6	-7	0	✓	0.22	G1052	S01
	A20Q-SDQCR 11	20	25	13	18	-	180	8	-5	0	✓	0.36	G1012	S08
	S20S-SDQCR 11	20	25	13	18	18.5	250	-	-5	0	-	0.60	G1012	S08
	A25R-SDQCR 11	25	32	17	23	23	200	8	-3	0	✓	0.65	G1012	S08
	S25T-SDQCR 11	25	32	17	23	23	300	-	-3	0	-	1.08	G1012	S08
	A32S-SDQCR 11-A	32	40	22	30	30	250	8	-10	0	✓	1.25	G1012	SD10
S32U-SDQCR 11-A	32	40	22	30	30	350	-	-10	0	-	2.10	G1012	SD10	
L	A10H-SDQCL 07	10	13	7	9	-	100	4	-10	0	✓	0.06	G1052	S02
	A12K-SDQCL 07	12	16	9	11	-	125	5	-7	0	✓	0.11	G1052	S02
	A16M-SDQCL 07	16	20	11	14.5	-	150	6	-7	0	✓	0.22	G1052	S01
	A20Q-SDQCL 11	20	25	13	18	-	180	8	-5	0	✓	0.37	G1012	S08
	S20S-SDQCL 11	20	25	13	18	18.5	250	-	-5	0	-	0.63	G1012	S08
	A25R-SDQCL 11	25	32	17	23	23	200	8	-3	0	✓	0.64	G1012	S08
	S25T-SDQCL 11	25	32	17	23	23	300	-	-3	0	-	1.15	G1012	S08
	A32S-SDQCL 11-A	32	40	22	30	30	250	8	-10	0	✓	1.32	G1012	SD10
S32U-SDQCL 11-A	32	40	22	30	30	350	-	-10	0	-	2.08	G1012	SD10	

	G1012													
	G1052													

SD10	US 3510-T15P	3.0	M 3.5	10.6	SDN 110304	MS 3510	FLAG T15P	HXK 3.5
S01	US 2506-T07P	0.9	M 2.5	6.3	-	-	FLAG T07P	-
S02	US 2505-T07P	0.9	M 2.5	5.2	-	-	FLAG T07P	-
S08	US 3510-T15P	3.0	M 3.5	10.6	-	-	FLAG T15P	-

SDUC(RL) INT

P
M
K
N
S
H

PRAMET

S



Internal Screw Lock Boring Bar with 93° Cutting Angle for DC.. Inserts

Internal Right/Left hand boring bar, through coolant available, 93° cutting angle for screw type DC.. inserts. For internal longitudinal turning with shoulder, taper, copying and chamfer turning. Body treated for longer tool life.

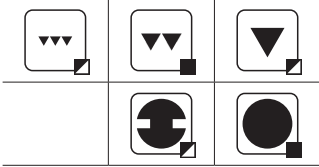
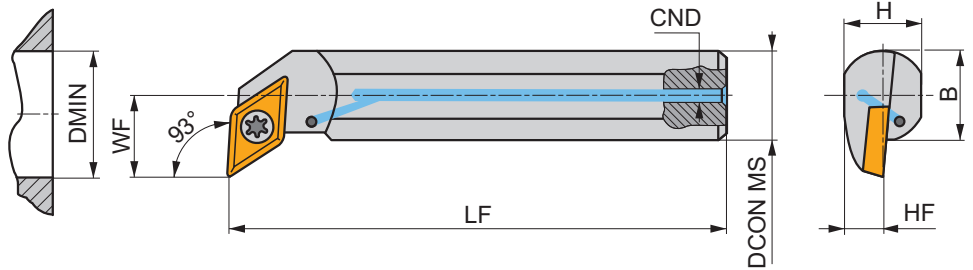
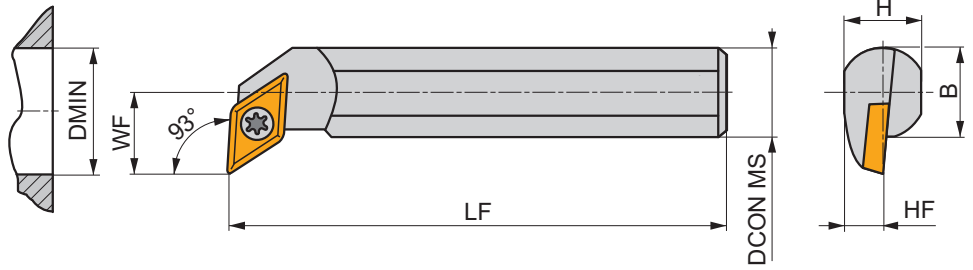
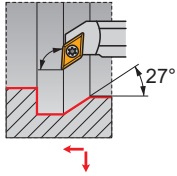

Product	DCON MS	DMIN	WF	H	B	LF	CND	LAMS	GAMO				
	(mm)	(mm)	(mm)	(mm)	(mm)	(mm)	(mm)	(°)	(°)				
R A10H-SDUCR 07	10	13	7	9	-	100	4	-10	0	✓	0.07	GI052	S02
A12K-SDUCR 07	12	16	9	11	-	125	5	-7	0	✓	0.12	GI052	S02
A16M-SDUCR 07	16	20	11	14.5	-	150	6	-7	0	✓	0.22	GI052	S01
A20Q-SDUCR 11	20	25	13	18	-	180	8	-3	0	✓	0.37	GI012	S08
S20S-SDUCR 11	20	25	13	18	18.5	250	-	-5	0	-	0.60	GI012	S08
A25R-SDUCR 11	25	32	17	23	23	200	8	-3	0	✓	0.60	GI012	S08
S25T-SDUCR 11	25	32	17	23	23	300	-	-3	0	-	1.09	GI012	S08
A32S-SDUCR 11-A	32	40	22	30	30	250	8	-10	0	✓	1.30	GI012	SD10
S32U-SDUCR 11-A	32	40	22	30	30	350	-	-10	0	-	2.10	GI012	SD10
L A10H-SDUCL 07	10	13	7	9	-	100	4	-10	0	✓	0.07	GI052	S02
A12K-SDUCL 07	12	16	9	11	-	125	5	-7	0	✓	0.11	GI052	S02
A16M-SDUCL 07	16	20	11	14.5	-	150	6	-7	0	✓	0.22	GI052	S01
A20Q-SDUCL 11	20	25	13	18	-	180	8	-3	0	✓	0.37	GI012	S08
S20S-SDUCL 11	20	25	13	18	18.5	250	-	-5	0	-	0.60	GI012	S08
A25R-SDUCL 11	25	32	17	23	23	200	8	-3	0	✓	0.66	GI012	S08
S25T-SDUCL 11	25	32	17	23	23	300	-	-3	0	-	1.09	GI012	S08
A32S-SDUCL 11-A	32	40	22	30	30	250	8	-10	0	✓	0.00	GI012	SD10
S32U-SDUCL 11-A	32	40	22	30	30	350	-	-10	0	-	2.09	GI012	SD10

	GI012	DC.. 11T3..
	GI052	DC.. 0702..

SD10	US 3510-T15P	3.0	M 3.5	10.6	SDN 110304	MS 3510	FLAG T15P	HXK 3.5
S01	US 2506-T07P	0.9	M 2.5	6.3	-	-	FLAG T07P	-
S02	US 2505-T07P	0.9	M 2.5	5.2	-	-	FLAG T07P	-
S08	US 3510-T15P	3.0	M 3.5	10.6	-	-	FLAG T15P	-

SDUC(RL)-E INT

P M K N S H

PRAMET

S



Internal Carbide Screw Lock Boring Bar with 93° Cutting Angle for DC.. Inserts

Internal Right/Left hand carbide boring bar, through coolant, 93° cutting angle for screw type positive DC.. inserts. For internal longitudinal turning with shoulder, taper, copying and chamfer turning. For tool overhang >3xD.

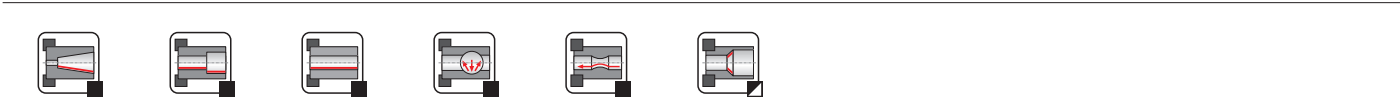
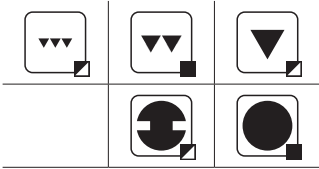
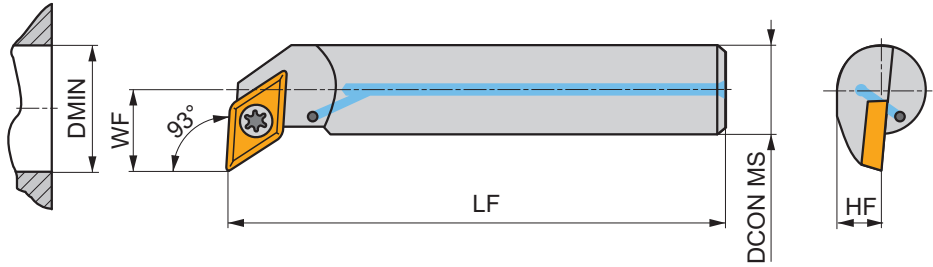
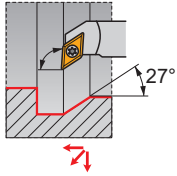

Product	DCON MS	DMIN	WF	HF	LF	LAMS	GAMO					
	(mm)	(mm)	(mm)	(mm)	(mm)	(°)	(°)					
R E10M-SDUCR 07-ER	10	15	9	5.6	150	-5	0	✓	0.14	GI052	SD21	
	E12Q-SDUCR 07-ER	12	18	11	6.5	150	-5	0	✓	0.26	GI052	SD21
	E16R-SDUCR 07-ER	16	22	13	8.5	150	-5	0	✓	0.49	GI052	SD21
L E10M-SDUCL 07-ER	10	15	9	5.6	150	-5	0	✓	0.15	GI052	SD21	
	E12Q-SDUCL 07-ER	12	18	11	6.5	150	-5	0	✓	0.26	GI052	SD21
	E16R-SDUCL 07-ER	16	22	13	8.5	150	-5	0	✓	0.50	GI052	SD21

GI052
 DC.. 0702..

SD21
 5513 020-03
 0.8
 M 2.5
 6.5
 PT-8001

SDZC(RL) INT

P
M
K
N
S
H

PRAMET

S



Internal Screw Lock Boring Bar with 93° Cutting Angle for DC.. Inserts

Internal Right/Left hand boring bar with 93° cutting angle for screw type DC.. inserts. Suited for internal longitudinal back turning with shoulder, taper, copying and chamfer turning. Body treated for longer tool life.

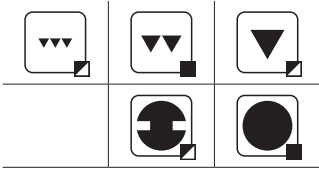
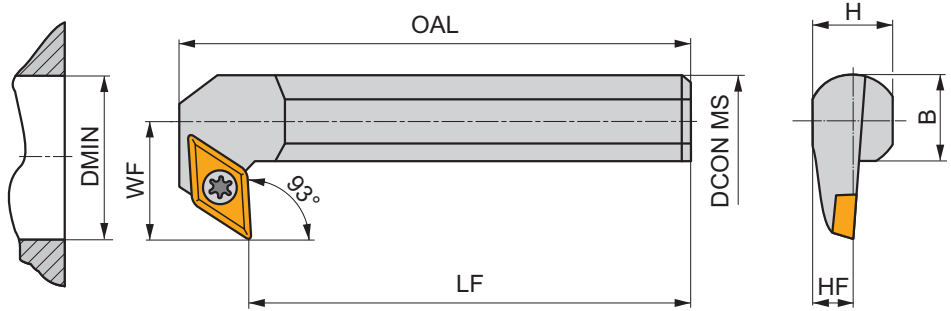
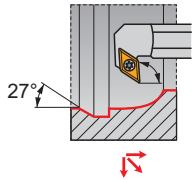

Product	DCON MS	DMIN	WF	H	B	LF	OAL	LAMS	GAMO	kg		
	(mm)	(mm)	(mm)	(mm)	(mm)	(mm)	(mm)	(°)	(°)			
R	S16M-SDZCR 07-93	16	27	17	14.5	15	150	163	-4	0	0.26	GI052 S01
	S20Q-SDZCR 11-93	20	35	22	18	18.5	180	198	-5	0	0.49	GI012 S08
	S25R-SDZCR 11-93	25	42	27	23	23	200	218	-3	0	0.79	GI012 S08
	S32S-SDZCR 11-93-A	32	53	35	30	30	250	268	-6	0	1.62	GI012 SD10
	S40T-SDZCR 11-93-A	40	65	43	38	38	300	322	-5	0	3.00	GI012 SD10
L	S16M-SDZCL 07-93	16	27	17	14.5	15	150	163	-4	0	0.27	GI052 S01
	S20Q-SDZCL 11-93	20	35	22	18	18.5	180	198	-5	0	0.48	GI012 S08
	S25R-SDZCL 11-93	25	42	27	23	23	200	218	-3	0	0.80	GI012 S08
	S32S-SDZCL 11-93-A	32	53	35	30	30	250	268	-6	0	1.60	GI012 SD10
	S40T-SDZCL 11-93-A	40	65	43	38	38	300	322	-5	0	3.00	GI012 SD10

GI012	DC.. 11T3..
GI052	DC.. 0702..

SD10	US 3510-T15P	3.0	M 3.5	10.6	SDN 110304	MS 3510	FLAG T15P	HXK 3.5
S01	US 2506-T07P	0.9	M 2.5	6.3	-	-	FLAG T07P	-
S08	US 3510-T15P	3.0	M 3.5	10.6	-	-	FLAG T15P	-

C.-SDUC(RL) INT

P
M
K
N
S
H

PRAMET

S



Internal PSC Quick Change Tool, Screw Lock, 93° Cutting Angle for DC.. Inserts

Internal Right/Left hand tool, through coolant, with 93° cutting angle for screw type DC.. inserts. Suited for a wide range of internal turning applications. Polygon Shank Coupling with choice of lengths. Body treated for longer tool life.

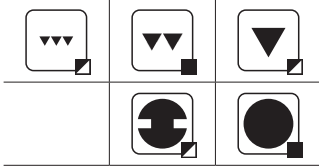
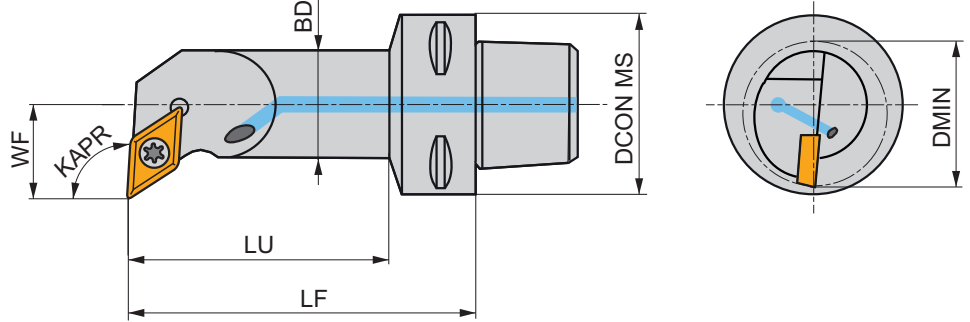
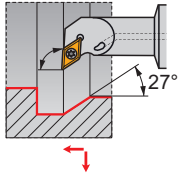

Product	DCON MS	DMIN	WF	LF	LU	BD	KAPR	LAMS	GAMO					
	(mm)	(mm)	(mm)	(mm)	(mm)	(mm)	(°)	(°)	(°)					
R	C3-SDUCR-11065-07	50	20	11	65	48	16	93	-4.3	0	✓	0.20	GI052	SV11
	C4-SDUCR-11070-07	40	20	11	70	47	16	93	-4.3	0	✓	0.35	GI052	SV11
	C4-SDUCR-13080-11	40	25	13	80	57	20	93	-5.8	0	✓	0.41	GI012	SC09M
	C4-SDUCR-17090-11	40	32	17	90	68	25	93	-3.4	0	✓	0.49	GI012	SV16
	C5-SDUCR-13080-11	50	25	13	80	56	20	93	-5.8	0	✓	0.60	GI012	SC09M
C5-SDUCR-17090-11	50	32	17	90	67	25	93	-3.4	0	✓	0.68	GI012	SV16	
L	C4-SDUCL-11070-07	40	20	11	70	47	16	93	-4.3	0	✓	0.35	GI052	SV11
	C4-SDUCL-13080-11	40	25	13	80	57	20	93	-5.8	0	✓	0.41	GI012	SC09M
	C4-SDUCL-17090-11	40	32	17	90	68	25	93	-3.4	0	✓	0.49	GI012	SV16
	C5-SDUCL-13080-11	50	25	13	80	56	20	93	-5.8	0	✓	0.60	GI012	SC09M



GI012 DC.. 11T3..
GI052 DC.. 0702..



SC09M	US 2009-T15P	3.0	M 3.5	8.1	FLAG T15P/3,5	-
SV11	US 2003-T07P	0.8	M 2.5	6.5	-	FLAG T07P
SV16	US 2010-T15P	3.0	M 3.5	10.1	-	FLAG T15P/3,5

SEGC(RL) EXT

P
M
K
N
S
H

PRAMET

S



External Screw Lock Tool Holder with 90° Cutting Angle for EC.. Inserts

External Right/Left hand tool holder with 90° cutting angle for screw type positive EC.. inserts. Suited for external face and longitudinal turning with shoulder, taper, chamfer and face turning. Body treated for longer tool life.

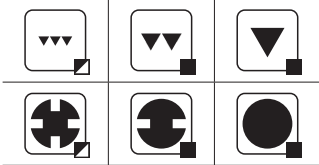
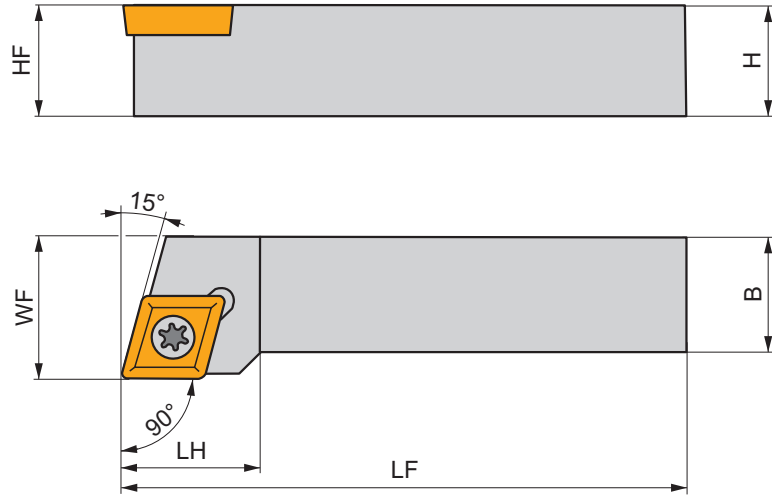
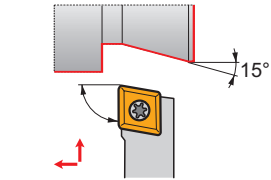

Product	H (mm)	B (mm)	HF (mm)	WF (mm)	LF (mm)	LH (mm)	LAMS (°)	GAMO (°)	kg		
R SEGCR 1212 N 08	12	12	12	16	160	12.0	0	0	0.15	GI210	SE08
SEGCR 1616 H 08	16	16	16	20	100	12.0	0	0	0.22	GI210	SE08
L SEGCL 1212 N 08	12	12	12	16	160	12.0	0	0	0.22	GI210	SE08
SEGCL 1616 H 08	16	16	16	20	100	12.0	0	0	2.14	GI210	SE08

GI210	EC..0803..

SE08	416.1-832	3.6	M3	8.5	PT-8002

SEUC(RL) INT

P M K N S H

PRAMET

S



Internal Screw Lock Boring Bar with 93° Cutting Angle for EC.. Inserts

Internal Right/Left hand boring bar with 93° cutting angle for screw type EC.. inserts. Suited for internal taper and longitudinal turning with shoulder and chamfer turning. Body treated for longer tool life.

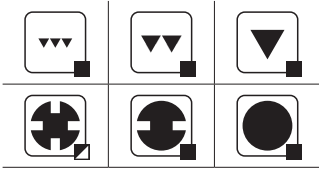
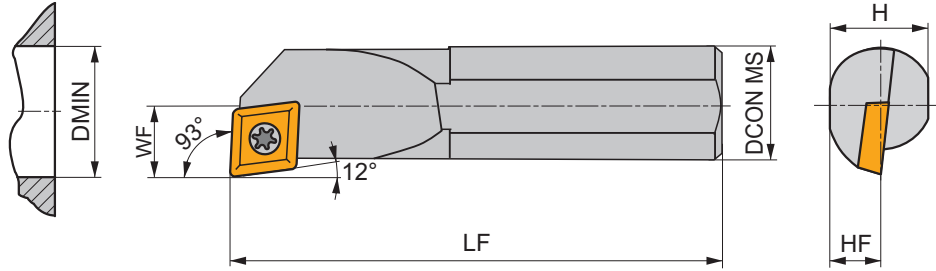
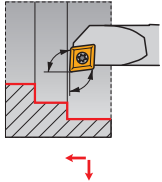

Product	DCON MS	DMIN	WF	H	HF	LF	LAMS	GAMO	kg			
	(mm)	(mm)	(mm)	(mm)	(mm)	(mm)	(°)	(°)				
R	S08K-SEUCR 06	8	11	7	7	3.5	125	-5	0	0.06	GI213	SE23
	S10M-SEUCR 06	10	13	8	9	4.5	150	-5	0	0.10	GI213	SE23
	S12M-SEUCR 08	12	15	9	11	5.5	150	-5	0	0.14	GI210	SE24
	S16R-SEUCR 08	16	20	11	15	7.5	200	-5	0	0.32	GI210	SE24
	S20S-SEUCR 08	20	25	13	18	9	250	-5	0	0.58	GI210	SE24
	S25T-SEUCR 08	25	32	17	23	11.5	300	-4	0	1.06	GI210	SE24
L	S08K-SEUCL 06	8	11	7	7	3.5	125	-5	0	0.06	GI213	SE23
	S10M-SEUCL 06	10	13	8	9	4.5	150	-5	0	0.10	GI213	SE23
	S12M-SEUCL 08	12	15	9	11	5.5	150	-5	0	0.14	GI210	SE24
	S16R-SEUCL 08	16	20	11	15	7.5	200	-5	0	0.32	GI210	SE24
	S20S-SEUCL 08	20	25	13	18	9	250	-5	0	0.58	GI210	SE24

GI210	EC.. 0803..
GI213	EC.. 0602..

SE23	5513 020-03	0.8	M 2.5	6.5	PT-8001
SE24	416.1-832	3.6	M 3	8.5	PT-8003

SELP(RL) INT

P
M
K
N
S
H

PRAMET

S



Internal Screw Lock Boring Bar with 95° Cutting Angle for EP.. Inserts

Internal Right/Left hand boring bar, through coolant available, with 95° cutting angle for screw type EP.. inserts. Suited for internal taper and longitudinal turning with shoulder and chamfer turning. Body treated for longer tool life.

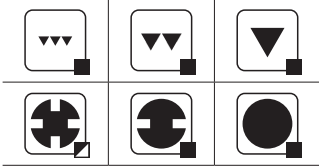
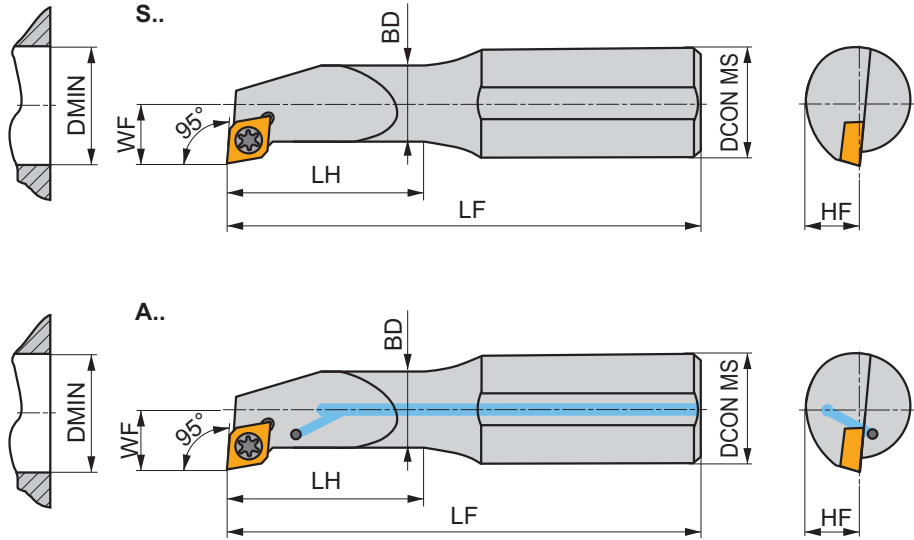
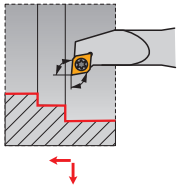

Product	DCON MS	DMIN	BD	WF	LF	LH	LAMS	GAMO				
	(mm)	(mm)	(mm)	(mm)	(mm)	(mm)	(°)	(°)				
R S0608H-SELPR 05	8	8	6	4.5	100	20.0	-10	0	-	0.04	GI212	SE21
S0810J-SELPR 05	10	11	8	6	110	26.0	-5	0	-	0.06	GI212	SE22
S1012K-SELPR 05	12	13	10	7	125	32.0	-5	0	-	0.11	GI212	SE22
A1216M-SELPR 05	16	16	12	9	150	40.0	-2	0	✓	0.18	GI212	SE22
S1216M-SELPR 05	16	16	12	9	150	40.0	-2	0	-	0.21	GI212	SE22
L S0608H-SELPL 05	8	8	6	4.5	100	20.0	-10	0	-	0.04	GI212	SE21
S0810J-SELPL 05	10	11	8	6	110	26.0	-5	0	-	0.06	GI212	SE22
S1012K-SELPL 05	12	13	10	7	125	32.0	-5	0	-	0.11	GI212	SE22
S1216M-SELPL 05	16	16	12	9	150	40.0	-2	0	-	0.21	GI212	SE22

	GI212		EP.. 0502..
--	-------	--	-------------

SE21	28992	0.8	M 2.2	4.2	MA2-8304
SE22	28588	0.8	M 2.2	5.6	MA2-8304

SELP(RL)-E INT

P
M
K
N
S
H

PRAMET

S



Internal Carbide Screw Lock Boring Bar with 95° Cutting Angle for EP.. Inserts

Internal Right/Left hand carbide boring bar, through coolant, with 95° cutting angle for screw type EP.. inserts. Suited for internal taper and longitudinal turning with shoulder and chamfer turning. For tool overhang >3xD.

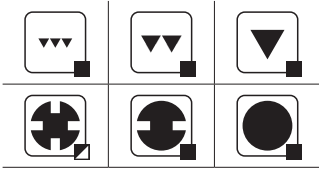
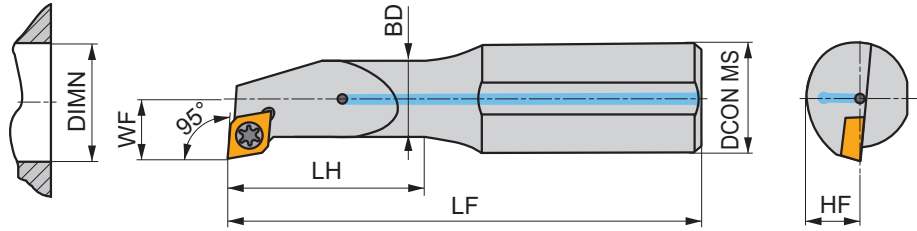
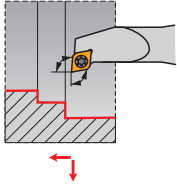

Product	DCON MS	DMIN	BD	WF	LF	LH	LAMS	GAMO				
	(mm)	(mm)	(mm)	(mm)	(mm)	(mm)	(°)	(°)				
R E0608H-SELPR 05	8	8	6	4.5	100	28.0	-10	0	✓	0.06	GI212	SE22
E0810J-SELPR 05	10	11	8	6	110	36.0	-5	0	✓	0.10	GI212	SE22
E1012K-SELPR 05	12	13	10	7	125	44.0	-5	0	✓	0.17	GI212	SE22
L E0608H-SELPL 05	8	8	6	4.5	100	28.0	-10	0	✓	0.06	GI212	SE22
E0810J-SELPL 05	10	11	8	6	110	36.0	-5	0	✓	0.10	GI212	SE22
E1216M-SELPL 05	16	16	12	9	150	55.0	-2	0	✓	0.33	GI212	SE22

GI212 EP.. 0502..

SE22 28588 0.8 M 2.2 5.6 MA2-8304

SEUP(RL) INT

P
M
K
N
S
H

PRAMET

S



Internal Screw Lock Boring Bar with 93° Cutting Angle for EP.. Inserts

Internal Right/Left hand boring bar with 93° cutting angle for screw type EP..inserts. Suited for internal taper and longitudinal turning with shoulder and chamfer turning. Body treated for longer tool life.

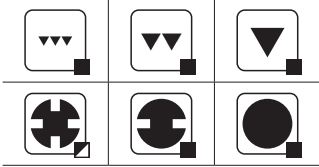
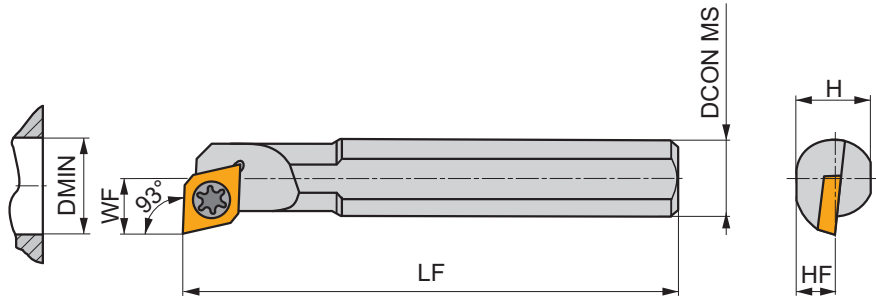
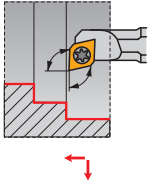

Product	DCON MS (mm)	DMIN (mm)	WF (mm)	H (mm)	HF (mm)	LF (mm)	LAMS (°)	GAMO (°)	kg		
R S06H-SEUPR 05	6	8.3	5	5.4	2.7	100	-7	0	0.04	GI212	SE21
L S06H-SEUPL 05	6	8.3	5	5.4	2.7	100	-7	0	0.05	GI212	SE21

	GI212		EP.. 0502..
--	-------	--	-------------

	SE21		28992		0.8		M 2.2		4.2		MA2-8304
--	------	--	-------	--	-----	--	-------	--	-----	--	----------

SEXP(RL) INT

P
M
K
N
S
H

PRAMET

S



Internal Screw Lock Boring Bar with 52.5° Cutting Angle for EP. Inserts

Internal Right/Left hand boring bar, 52.5° cutting angle for screw type EP. inserts. For internal back chamfer, taper, multi-directional, chamfer and longitudinal turning without shoulder. Body treated for longer tool life.

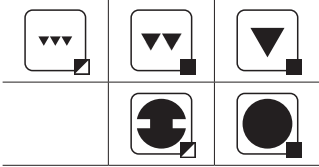
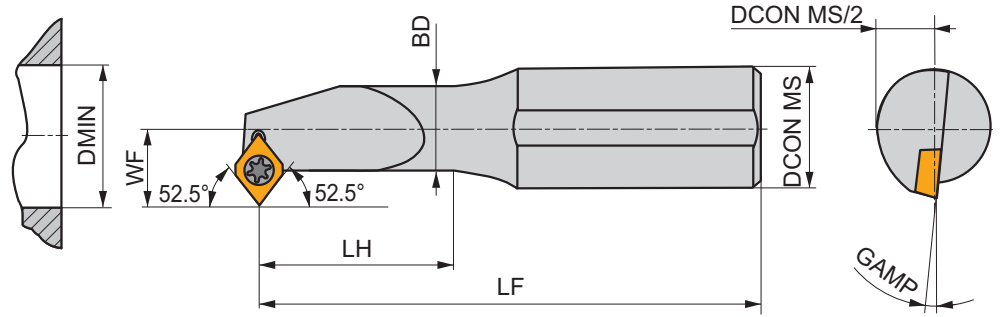
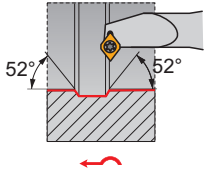

Product	DCON MS	DMIN	BD	WF	LF	LH	GAMP	kg		
	(mm)	(mm)	(mm)	(mm)	(mm)	(mm)	(°)			
R S0608H-SEXPR 05	8	9.5	6	5.5	100	20.0	-7	0.04	G1212	SE21
S0810J-SEXPR 05	10	11	8	6	110	26.0	-5	0.06	G1212	SE22
S1012K-SEXPR 05	12	13	10	7	125	32.0	-5	0.11	G1212	SE22
S1216M-SEXPR 05	16	16	12	9	150	40.0	-2	0.21	G1212	SE22
L S0608H-SEXPL 05	8	9.5	6	5.5	100	20.0	-7	0.04	G1212	SE21
S0810J-SEXPL 05	10	11	8	6	110	26.0	-5	0.06	G1212	SE22
S1012K-SEXPL 05	12	13	10	7	125	32.0	-5	0.11	G1212	SE22
S1216M-SEXPL 05	16	16	12	9	150	40.0	-2	0.21	G1212	SE22

G1212	EP. 0502..

SE21	28992	0.8	M 2.2	4.2	MA2-8304
SE22	28588	0.8	M 2.2	5.6	MA2-8304

SEXP(RL)-E INT

P
M
K
N
S
H

PRAMET

S



Internal Carbide Screw Lock Boring Bar, 52.5° Cutting Angle for EP.. Inserts

Internal Right/Left hand carbide boring bar, through coolant, 52.5° cutting angle for screw type EP.. inserts. For internal back chamfer, taper, multi-directional, chamfer and longitudinal turning without shoulder. For overhang > 3xD.

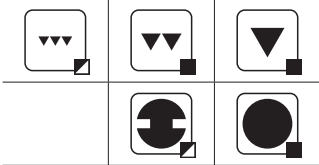
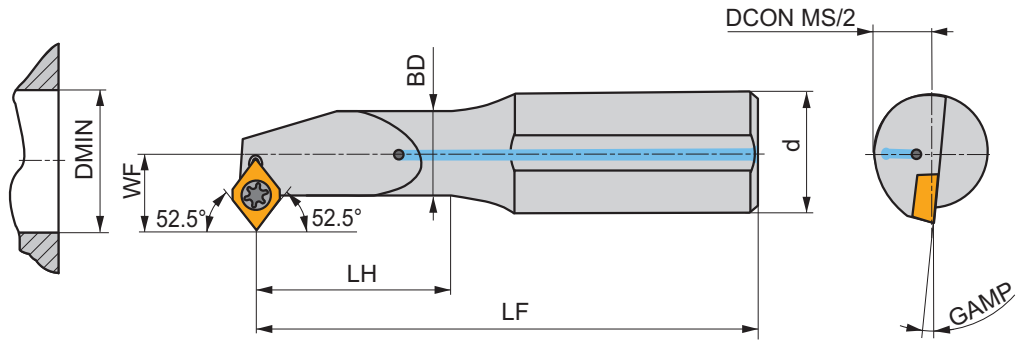
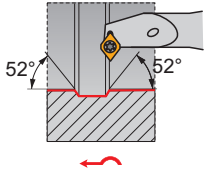

Product	DCON MS	DMIN	BD	WF	LF	LH	GAMP				
	(mm)	(mm)	(mm)	(mm)	(mm)	(mm)	(°)				
R E0608H-SEXPR 05	8	9.5	6	5.5	100	28.0	-7	✓	0.07	GI212	SE21
E0810J-SEXPR 05	10	11	8	6	110	36.0	-5	✓	0.10	GI212	SE22
E1012K-SEXPR 05	12	13	10	7	125	44.0	-5	✓	0.16	GI212	SE22
E1216M-SEXPR 05	16	16	12	9	150	55.0	-2	✓	0.32	GI212	SE22
L E0608H-SEXPL 05	8	9.5	6	5.5	100	28.0	-7	✓	0.06	GI212	SE21

	GI212		EP.. 0502..
--	-------	--	-------------

SE21	28992	0.8	M 2.2	4.2	MA2-8304
SE22	28588	0.8	M 2.2	5.6	MA2-8304

PRDCN EXT



PRAMET



External Lever Lock Tool Holder for Round RC.. Inserts

External neutral lever lock tool holder for positive RC.. inserts. Suited for external face and longitudinal turning without shoulder, copy turning up to 90°, taper and chamfer turning. Body treated for longer tool life.

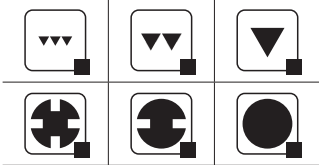
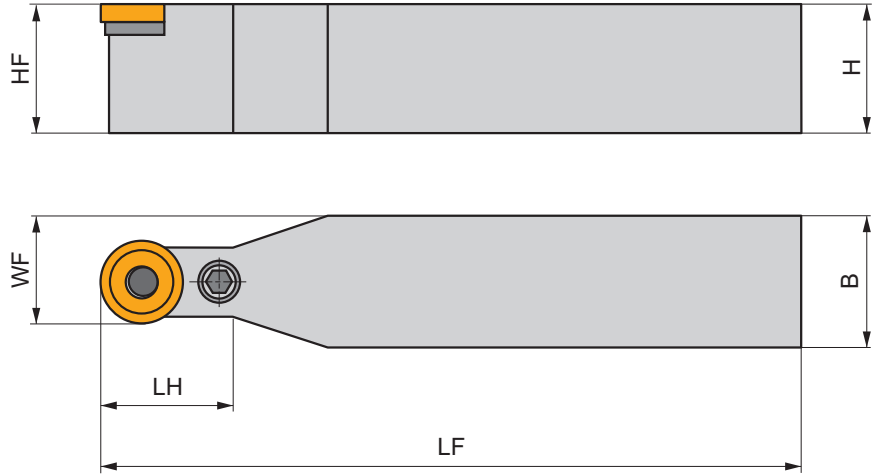
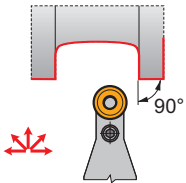

Product	H (mm)	B (mm)	HF (mm)	WF (mm)	LF (mm)	LH (mm)	LAMS (°)	GAMO (°)	kg		
N PRDCN 3225 P 16	32	25	32	20.5	170	34.0	0	0	0.80	GI090	PR01
PRDCN 3232 P 20	32	32	32	26	170	42.0	0	0	1.16	GI069	PR03
PRDCN 4040 S 20	40	40	40	30	250	40.0	0	0	2.82	GI069	PR03
PRDCN 4040 S 25	40	40	40	32.5	250	40.0	0	0	2.75	GI122	PR02
PRDCN 5050 V 32	50	50	50	41	400	52.0	0	0	7.30	GI096	PR04

GI069	RCMX 2006MO
GI090	RCMX 1606MO
GI096	RCMX 3209MO
GI122	RCMX 2507MO

PR01	PRS 816	CL 116	CS 706	2.0	M 6x1	20.7	TR 16	MT 05 HXK 2.5
PR02	PRS 825	CL 125	CS 710	3.5	M 10x1	30.4	TR 19	MT 06 HXK 4
PR03	PRS 820	CL 120	CS 708	3.0	M 8x1	23.5	TR 15	MT 07 HXK 3
PR04	PRS 832	CL 132	CS 612	4.0	M 12x1	36	TR 25	MT 08 HXK 5

PRSC(RL) EXT

P
M
K
N
S
H

PRAMET

P

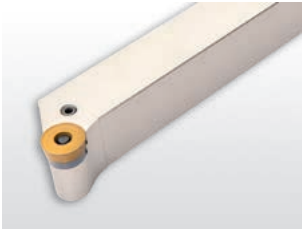

External Lever Lock Tool Holder for Round RC.. Inserts

External Right/Left hand lever lock tool holder for positive RC.. inserts. Suited for external face and longitudinal turning without shoulder, copy turning up to 27°, taper and chamfer turning, including face copy turning. Body treated for longer tool life.

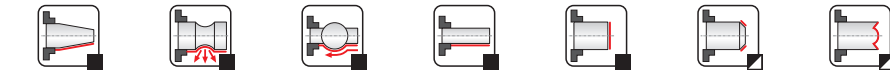
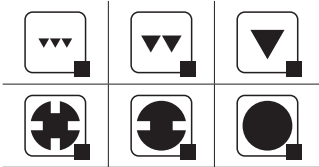
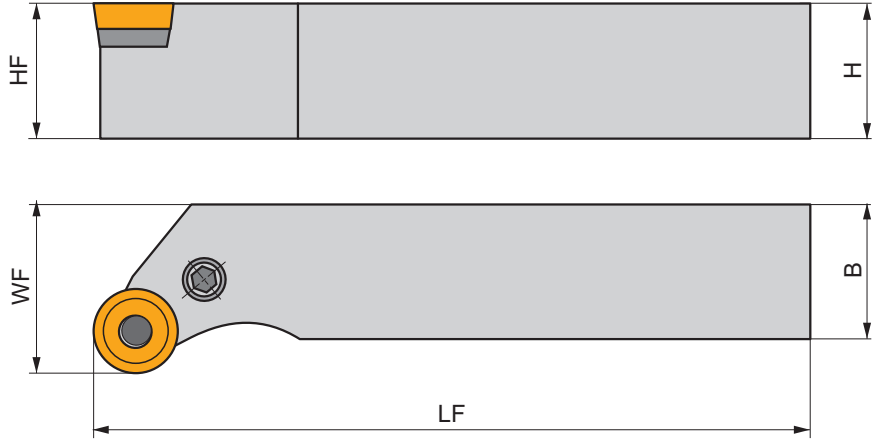
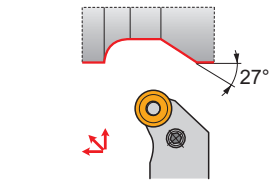

Product	H	B	HF	WF	LF	LAMS	GAMO	kg		
	(mm)	(mm)	(mm)	(mm)	(mm)	(°)	(°)			
R PRSCR 3225 P 16	32	25	32	32	170	0	0	1.05	GI090	PR01
PRSCR 3232 P 20	32	32	32	40	170	0	0	1.29	GI069	PR03
PRSCR 4040 S 16	40	40	40	50	250	0	0	3.00	GI090	PR01
PRSCR 4040 S 25	40	40	40	50	250	0	0	3.04	GI122	PR02
L PRSCL 3225 P 16	32	25	32	32	170	0	0	0.90	GI090	PR01
PRSCL 4040 S 16	40	40	40	50	250	0	0	2.38	GI090	PR01
PRSCL 3232 P 20	32	32	32	40	170	0	0	1.32	GI069	PR03
PRSCL 4040 S 25	40	40	40	50	250	0	0	3.06	GI122	PR02

GI069	RCMX 2006MO
GI090	RCMX 1606MO
GI122	RCMX 2507MO

PR01	PRS 816	CL 116	CS 706	2.0	M 6x1	20.7	TR 16	MT 05	HXK 2.5
PR02	PRS 825	CL 125	CS 710	3.5	M 10x1	30.4	TR 19	MT 06	HXK 4
PR03	PRS 820	CL 120	CS 708	3.0	M 8x1	23.5	TR 15	MT 07	HXK 3

SRDC(RL) EXT

P
M
K
N
S
H

PRAMET

S



External Screw Lock Tool Holder for Round RC.. Inserts

External Right/Left hand tool holder for screw type positive RC.. inserts. Suited for external face and longitudinal turning without shoulder, taper and chamfer turning. Body treated for longer tool life.

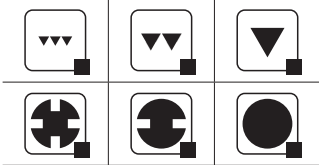
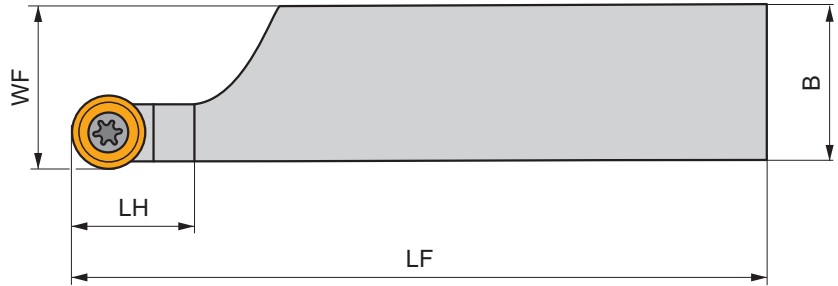
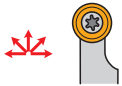
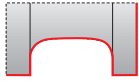

Product	H (mm)	B (mm)	HF (mm)	WF (mm)	LF (mm)	LH (mm)	LAMS (°)	GAMO (°)	kg		
R SRDCR 2020 K 08-A	20	20	20	20.5	125	20.0	0	0	0.36	GI051	SR21
SRDCR 2525 M 08-A	25	25	25	25.5	150	20.0	0	0	0.66	GI051	SR21
SRDCR 3225 P 08-A	32	25	32	25.5	170	20.0	0	0	0.95	GI051	SR21
L SRDCL 2020 K 08-A	20	20	20	20.5	125	20.0	0	0	0.37	GI051	SR21
SRDCL 2525 M 08-A	25	25	25	25.5	150	20.0	0	0	0.66	GI051	SR21
SRDCL 3225 P 08-A	32	25	32	25.5	170	20.0	0	0	0.96	GI051	SR21

GI051 RC..0803M0

SR21 5513 020-04 1.5 M3 7.2 PT-8002

SRDCN EXT



PRAMET



External Screw Lock Tool Holder for Round RC.. Inserts

External neutral tool holder for screw type positive RC.. inserts. Suited for external face and longitudinal turning without shoulder, copy, taper and chamfer turning. Body treated for longer tool life.

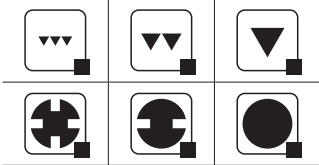
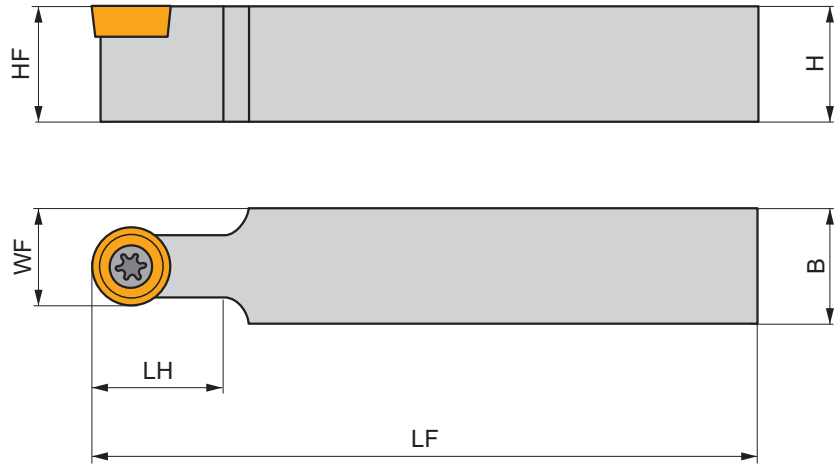
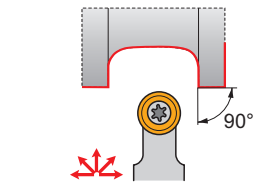

Product	H (mm)	B (mm)	HF (mm)	WF (mm)	LF (mm)	LH (mm)	LAMS (°)	GAMO (°)	kg	GI	SR
SRDCN 1212 F 06	12	12	12	9	80	12.0	0	0	0.10	GI054	SO1
SRDCN 1616 H 06	16	16	16	11	100	12.0	0	0	0.20	GI054	SO1
SRDCN 2020 K 08	20	20	20	14	125	20.0	0	0	0.37	GI051	SO3
SRDCN 2020 K 1003-M-A	20	20	20	15	125	25.0	0	0	0.38	GI064	SR10
SRDCN 2020 K 10-M-A	20	20	20	15	125	25.0	0	0	0.37	GI013	SR10
SRDCN 2525 M 10-M-A	25	25	25	17.5	150	25.0	0	0	0.67	GI013	SR10
SRDCN 2525 M 12-M-A	25	25	25	18.5	150	30.0	0	0	0.08	GI014	SR12
SRDCN 3225 P 10-M	32	25	32	17.5	170	25.0	0	0	0.90	GI013	SR10
SRDCN 3225 P 12-M	32	25	32	18.5	170	30.0	0	0	0.90	GI014	SR12
SRDCN 3225 P 16-M	32	25	32	20.5	170	32.0	0	0	1.00	GI161	SR16

GI	RC..
GI013	RC.. 10T3MO
GI014	RC.. 1204MO
GI051	RC.. 0803MO
GI054	RC.. 0602MO
GI064	RC.. 1003MO
GI161	RC.. 1606MO

SR	US	Nm	M	mm	mm	mm	mm	mm	mm
SO1	US 2506-T07P	0.9	M 2.5	6.3	-	-	FLAG T07P	-	-
SO3	US 3007-T09P	2.0	M 3	7.3	-	-	FLAG T09P	-	-
SR10	US 3510-T15P	3.0	M 3.5	10.6	SRN 100300	MS 3510	FLAG T15P	HXK 3.5	-
SR12	US 3510-T15P	3.0	M 3.5	10.6	SRN 120300	MS 3510	FLAG T15P	HXK 3.5	-
SR16	US 5018-T20P	5.0	M 5	18.2	SRN 16T3MO	MS 5015	FLAG T20P	HXK 5	-

SRSC(RL) EXT



PRAMET







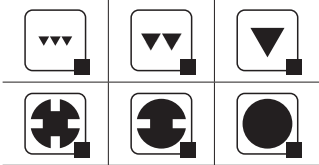
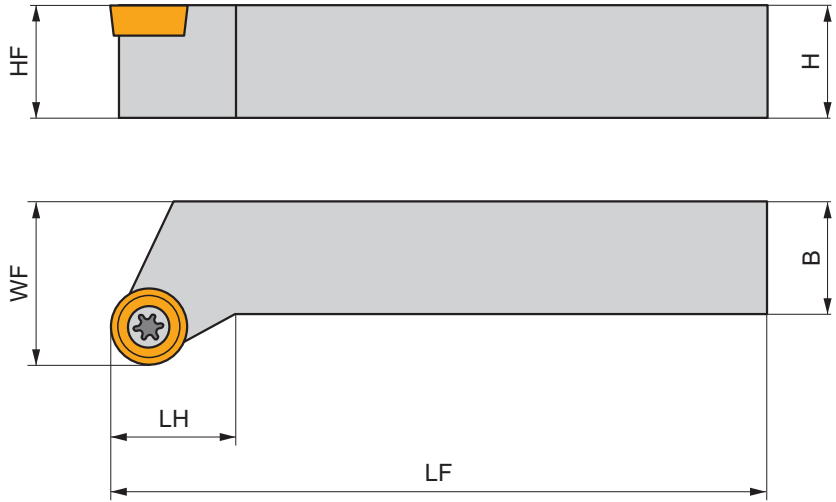
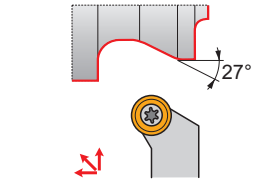



External Screw Lock Tool Holder for Round RC.. Inserts

External Right/Left hand tool holder for screw type positive RC.. inserts. Suited for external face and longitudinal turning without shoulder, copy, taper and chamfer turning. Body treated for longer tool life.



Product	H	B	HF	WF	LF	LH	LAMS	GAMO	kg			
	(mm)	(mm)	(mm)	(mm)	(mm)	(mm)	(°)	(°)				
R	SRSCR 1212 F 06	12	12	12	16	80	12.0	0	0	0.09	GI054	S01
	SRSCR 1616 H 06	16	16	16	20	100	12.0	0	0	0.21	GI054	S01
	SRSCR 2020 K 08	20	20	20	25	125	20.0	0	0	0.40	GI051	S03
	SRSCR 2020 K 10-M-A	20	20	20	25	125	20.0	0	0	0.41	GI013	SR10
	SRSCR 2525 M 10-M-A	25	25	25	32	150	20.0	0	0	0.75	GI013	SR10
	SRSCR 3225 P 10-M	32	25	32	32	170	20.0	0	0	1.06	GI013	SR10
	SRSCR 2525 M 12-M-A	25	25	25	32	150	20.0	0	0	0.75	GI014	SR12
SRSCR 3225 P 16-M	32	25	32	32	170	20.0	0	0	1.08	GI161	SR16	
L	SRSC L 1212 F 06	12	12	12	16	80	12.0	0	0	0.10	GI054	S01
	SRSC L 1616 H 06	16	16	16	20	100	12.0	0	0	0.22	GI054	S01
	SRSC L 2020 K 08	20	20	20	25	125	20.0	0	0	0.45	GI051	S03
	SRSC L 2020 K 10-M-A	20	20	20	25	125	20.0	0	0	0.42	GI013	SR10
	SRSC L 2525 M 10-M-A	25	25	25	32	150	20.0	0	0	0.74	GI013	SR10
	SRSC L 3225 P 10-M	32	25	32	32	170	20.0	0	0	1.06	GI013	SR10
	SRSC L 2525 M 12-M-A	25	25	25	32	150	20.0	0	0	0.75	GI014	SR12
SRSC L 3225 P 16-M	32	25	32	32	170	20.0	0	0	1.08	GI161	SR16	

GI013	RC.. 10T3M0
GI014	RC.. 1204M0
GI051	RC.. 0803M0
GI054	RC.. 0602M0
GI161	RC.. 1606M0

		 Nm						
S01	US 2506-T07P	0.9	M 2.5	6.3	–	–	FLAG T07P	–
S03	US 3007-T09P	2.0	M 3	7.3	–	–	FLAG T09P	–
SR10	US 3510-T15P	3.0	M 3.5	10.6	SRN 100300	MS 3510	FLAG T15P	HXK 3.5
SR12	US 3510-T15P	3.0	M 3.5	10.6	SRN 120300	MS 3510	FLAG T15P	HXK 3.5
SR16	US 5018-T20P	5.0	M 5	18.2	SRN 16T3M0	MS 5015	FLAG T20P	HXK 5

C.-SRDCN EXT

P
M
K
N
S
H

PRAMET

S



External PSC Quick Change Tool, Screw Lock for RC.. Inserts

External neutral tool, through coolant, for screw type positive RC.. inserts. Suited for external face and longitudinal turning without shoulder, copy, taper and chamfer turning. Polygon Shank Coupling. Body treated for longer tool life.

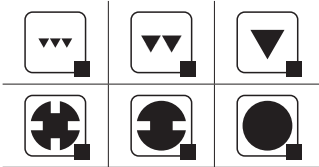
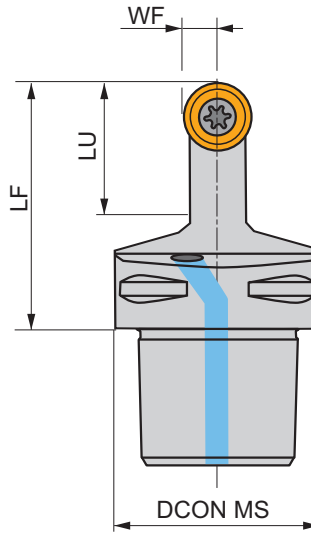
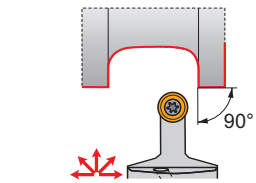

Product	DCON MS (mm)	WF (mm)	LF (mm)	LU (mm)	LAMS (°)	GAMO (°)		kg		
N C4-SRDCN-00050-12A	40	6	50	28	0	0	✓	0.32	G1014	C-SR12V-1
C5-SRDCN-00060-10A	50	5	60	25	0	0	✓	0.56	G1013	C-SR10V
C5-SRDCN-00060-12A	50	6	60	28	0	0	✓	0.56	G1014	C-SR12V-2

G1013	RC.. 10T3M0
G1014	RC.. 1204M0

C-SR10V	US 2010-T15P	3.0	M 3.5	10.1	SRS 110-01	MS 9001	FLAG T15P/3,5	CN 034-02
C-SR12V-1	US 2001-T15P	3.0	M 3.5	12.1	SRS 110-02	MS 9001	FLAG T15P/3,5	CN 034-01
C-SR12V-2	US 2001-T15P	3.0	M 3.5	12.1	SRS 110-02	MS 9001	FLAG T15P/3,5	CN 034-02

KHP-RSC(RL)



PRAMET



Modular KHP Lever Lock Turning Cartridge for RC.. Inserts

Dovetailed Right/Left hand lever lock turning cartridge for mounting on DKH tool holder shank. Suited for heavy longitudinal turning without shoulder, face turning, taper and chamfer turning with positive RC.. inserts. Tool holder treated for longer tool life.

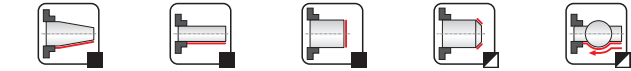
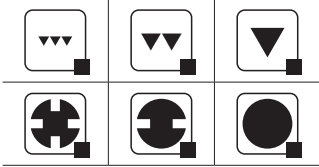
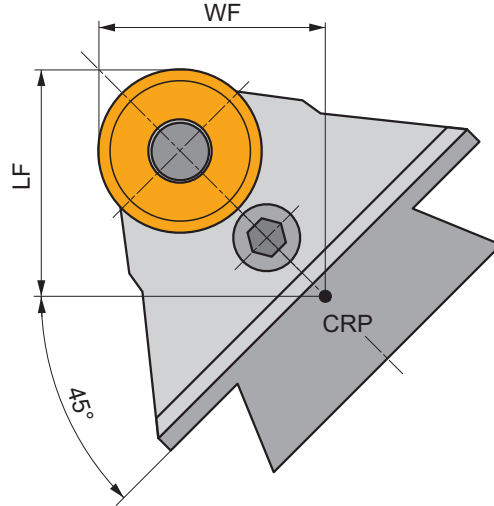
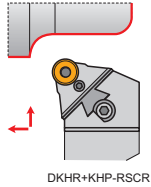

Product	WF (mm)	LF (mm)	LAMS (°)	GAMO (°)	kg		
R KHP-RSCR 20	35	45	0	0	1.25	G1069	PRP90
KHP-RSCL 20	35	45	0	0	1.30	G1069	PRP90

G1069	RCMX 2006M0

PRP90	RCU 200400	CL 120	US 36	6.0	M 8x1	26	NT 07	MT 07	HXK 4

DKH(RL)



External Tool Holder Shank for KHP/KHS Heavy Turning Cartridges

Dovetailed Right/Left hand modular tool shank for KHP/KHS cartridges. Suited for heavy turning applications. Body treated for longer tool life.

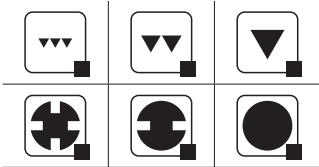
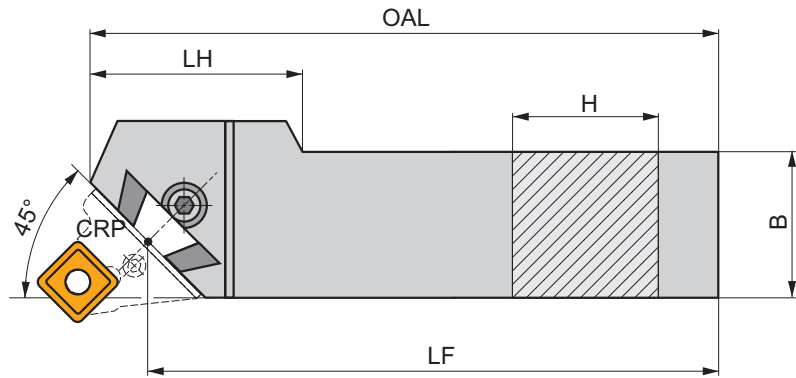
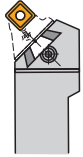

Product	H	B	LF	OAL	LH	kg		
	(mm)	(mm)	(mm)	(mm)	(mm)			
R DKHR 4050 V	40	50	400	425	100.0	7.10	GI098	DKH10
DKHR 5060 W	50	60	450	475	110.0	11.30	GI098	DKH10
DKHR 6080 W-A	60	80	450	485	90.0	19.65	GI098	DKH10
L DKHL 4050 V	40	50	400	425	100.0	7.10	GI098	DKH10
DKHL 5060 W	50	60	450	475	110.0	11.30	GI098	DKH10
DKHL 6080 W-A	60	80	450	485	90.0	19.28	GI098	DKH10

GI098	KHP	KHS

DKH10	SR 14	HXK 10

SSBC(RL) EXT



PRAMET



External Screw Lock Tool Holder with 75° Cutting Angle for SC.. Inserts

External Right/Left hand tool holder for screw type positive SC.. inserts. Suited for external longitudinal turning without shoulder, taper and chamfer turning. Body treated for longer tool life.

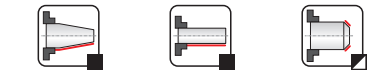
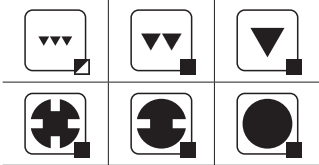
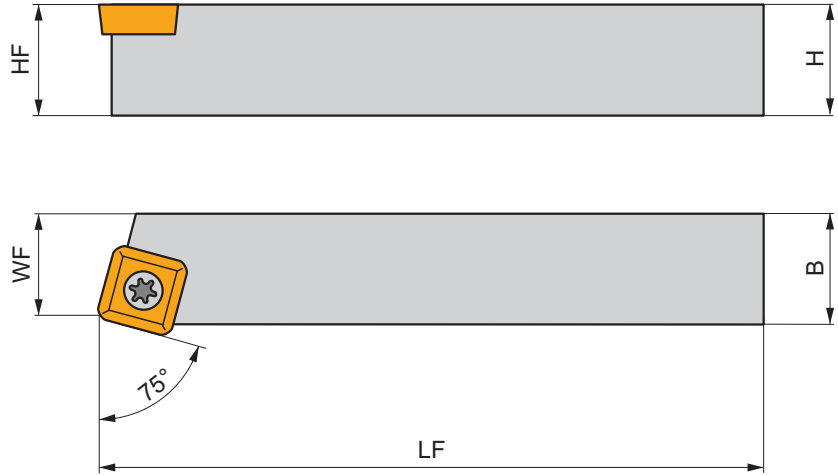
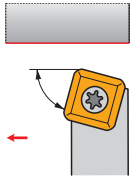

	Product	H	B	H _F	W _F	L _F	LAMS	GAMO	kg	GI	SS
		(mm)	(mm)	(mm)	(mm)	(mm)	(°)	(°)			
R	SSBCR 1212 F 09	12	12	12	11	80	0	0	0.10	GI053	S08
	SSBCR 1616 H 09	16	16	16	13	100	0	0	0.20	GI053	S08
	SSBCR 2020 K 12-M-A	20	20	20	17	125	0	0	0.40	GI015	SS20
	SSBCR 2525 M 12-M-A	25	25	25	22	150	0	0	0.76	GI015	SS20
	SSBCR 4040 S 25	40	40	40	35	250	0	0	3.01	GI131	SS25
	SSBCR 5050 T 25	50	50	50	43	300	0	0	5.65	GI131	SS25
	SSBCR 5050 T 38-A	50	50	50	43	300	0	0	4.84	GI164	SS38A
	SSBCR 6060 V 38-A	60	60	60	53	400	0	0	11.10	GI164	SS38A
L	SSBCL 1212 F 09	12	12	12	11	80	0	0	0.10	GI053	S08
	SSBCL 1616 H 09	16	16	16	13	100	0	0	0.22	GI053	S08
	SSBCL 2020 K 12-M-A	20	20	20	17	125	0	0	0.40	GI015	SS20
	SSBCL 2525 M 12-M-A	25	25	25	22	150	0	0	0.70	GI015	SS20
	SSBCL 4040 S 25	40	40	40	35	250	0	0	3.01	GI131	SS25
	SSBCL 5050 T 25	50	50	50	43	300	0	0	5.65	GI131	SS25
	SSBCL 5050 T 38-A	50	50	50	43	300	0	0	5.78	GI164	SS38A
	SSBCL 6060 V 38-A	60	60	60	53	400	0	0	11.16	GI164	SS38A

GI	SC..
GI015	SC.. 1204..
GI053	SC.. 09T3..
GI131	SC.. 2509..
GI164	SC.. 3809..

S08	US 3510-T15P	3.0	M 3.5	10.6	-	-	FLAG T15P	-	-
SS20	US 5012-T15P	5.0	M 5	12.2	SSN 120304	MS 5008	FLAG T15P	HXK 5	-
SS25	US 8025-T30P	13.0	M 8	24.2	SSN 250620	MS 8020	-	HXK 5	SDRT30P
SS38A	US 8025-T30P	13.0	M 8	24.2	SSN 380920	MS 8020	-	HXK 5	SDRT30P

SSDCN EXT

P
M
K
N
S
H

PRAMET

S



External Screw Lock Tool Holder with 45° Cutting Angle for SC.. Inserts

External neutral tool holder for screw type positive SC.. inserts. Suited for external longitudinal turning without shoulder, copy, taper and chamfer turning. Body treated for longer tool life.

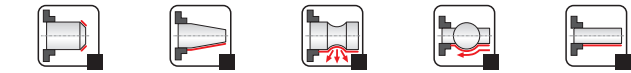
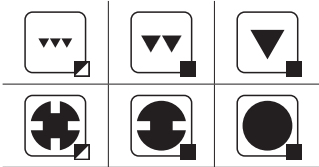
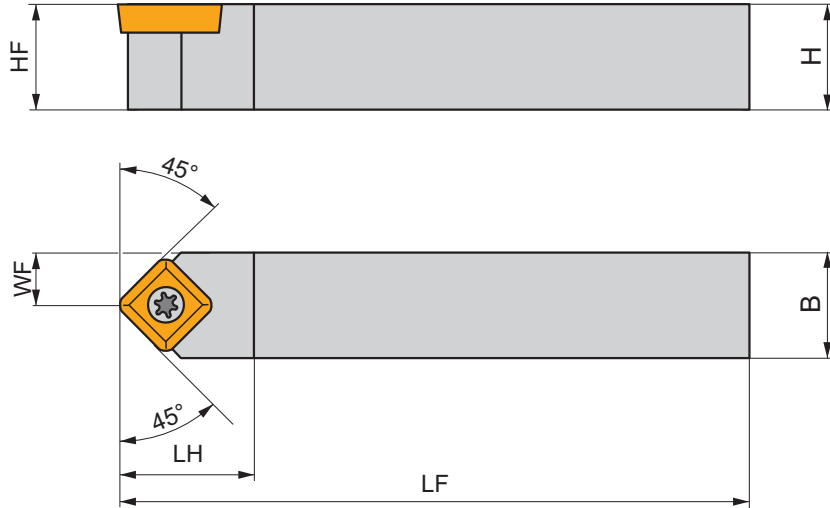
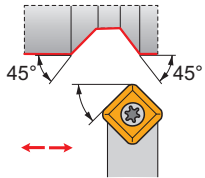

Product	H (mm)	B (mm)	HF (mm)	WF (mm)	LF (mm)	LH (mm)	LAMS (°)	GAMO (°)	kg	GI053	SS20
N SSDCN 1212 F 09	12	12	12	6	80	-	0	0	0.11	GI053	S08
SSDCN 1616 H 09	16	16	16	8	100	-	0	0	0.20	GI053	S08
SSDCN 2020 K 12-M-A	20	20	20	10	125	-	0	0	0.41	GI015	SS20
SSDCN 2525 M 12-M-A	25	25	25	12.5	150	-	0	0	0.74	GI015	SS20

GI015	GI053	SC.. 1204..	SC.. 09T3..

S08	US 3510-T15P	3.0	M 3.5	10.6	-	-	FLAG T15P	-
SS20	US 5012-T15P	5.0	M 5	12.2	SSN 120304	MS 5008	FLAG T15P	HXK 5

SSKC(RL) EXT

P
M
K
N
S
H

PRAMET

S



Ext. Screw Lock Tool Holder, 75° (Face Turning) Cutting Angle for SC.. Insert

External Right/Left hand tool holder for screw type positive SC.. inserts. Suited for external face turning without shoulder and chamfer turning. Body treated for longer tool life.

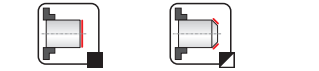
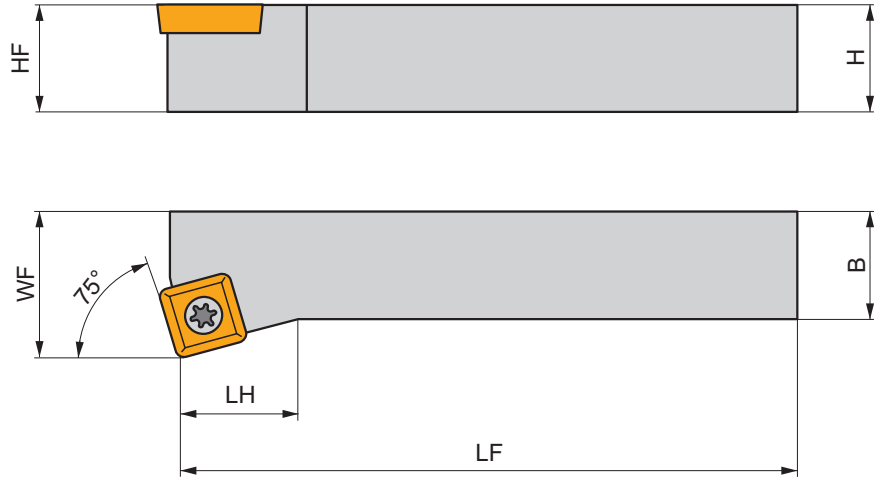
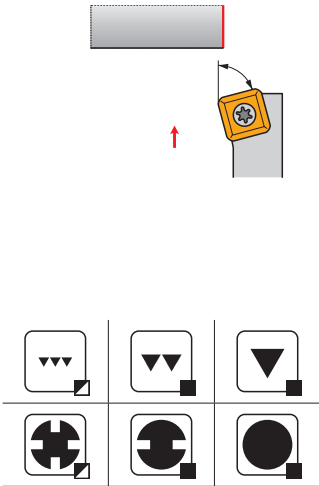

Product	H (mm)	B (mm)	HF (mm)	WF (mm)	LF (mm)	LH (mm)	LAMS (°)	GAMO (°)	kg	GI053	SS20
R SSKCR 1212 F 09	12	12	12	16	80	32.0	0	0	0.10	GI053	S08
SSKCR 1616 H 09	16	16	16	20	100	32.0	0	0	0.25	GI053	S08
SSKCR 2020 K 12-M-A	20	20	20	25	125	36.0	0	0	0.75	GI015	SS20
SSKCR 2525 M 12-M-A	25	25	25	32	150	36.0	0	0	0.75	GI015	SS20

GI015	SC.. 1204..
GI053	SC.. 09T3..

S08	US 3510-T15P	3.0	M 3.5	10.6	-	-	FLAG T15P	-
SS20	US 5012-T15P	5.0	M 5	12.2	SSN 120304	MS 5008	FLAG T15P	HXK 5

SSSC(RL) INT

P
M
K
N
S
H

PRAMET

S



Internal Screw Lock Boring Bar with 45° Cutting Angle for SC.. Inserts

Internal Right/Left hand boring bar with 45° cutting angle for screw type SC.. inserts. For internal back chamfer, taper, multi-directional, chamfer and longitudinal turning without shoulder. Body treated for longer tool life.

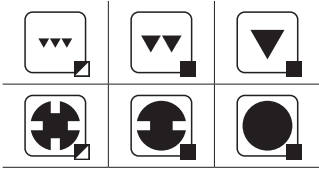
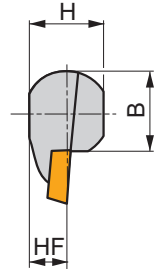
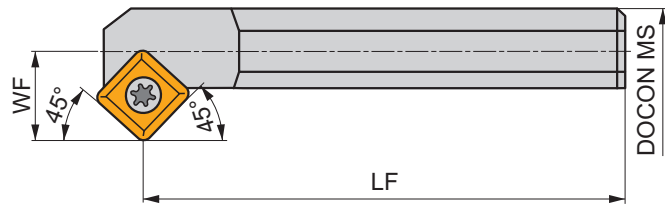
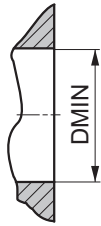
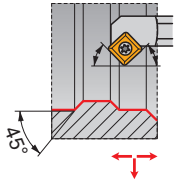

Product	DCON MS	DMIN	WF	H	B	LF	LAMS	GAMO	kg		
	(mm)	(mm)	(mm)	(mm)	(mm)	(mm)	(°)	(°)			
R S20S-SSSCR 09	20	25	13	18	18.5	250	-5	0	0.61	G1053	S04
	S25T-SSSCR 09	25	32	17	23	23	-3	0	1.10	G1053	S04
L S20S-SSSCL 09	20	25	13	18	18.5	250	-5	0	0.05	G1053	S04
	S25T-SSSCL 09	25	32	17	23	23	-3	0	1.10	G1053	S04

G1053	SC..09T3..

S04	US 3510-T15P	3.0	M 3.5	10.6	FLAG T15P

KHS-SBC(RL)



PRAMET



Modular KHS Screw Clamp Turning Cartridge 75° Cutting Angle for SC.. Inserts

Dovetailed Right/Left hand screw lock turning cartridge, 75° cutting angle, for mounting on DKH tool holder shank. Suited for heavy longitudinal turning without shoulder, face turning, taper and chamfer turning with positive SC.. inserts Tool holder treated for longer tool life.

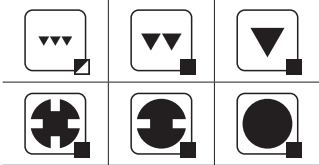
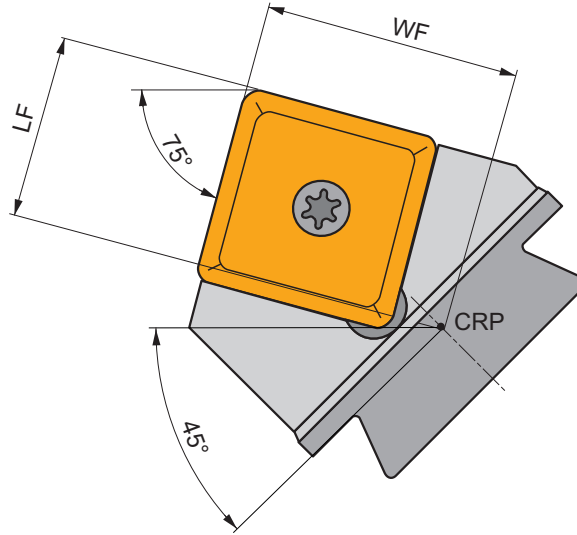
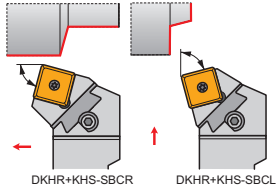

Product	WF (mm)	LF (mm)	LAMS (°)	GAMO (°)	kg		
R KHS-SBCR 25	47	36	0	0	1.50	G131	SS26
KHS-SBCR 38-A	47	36	0	0	1.47	G164	SS38
L KHS-SBCL 25	47	36	0	0	1.45	G131	SS26
KHS-SBCL 38-A	47	36	0	0	1.48	G164	SS38

G131	SC.. 2509..
G164	SC.. 3809..

SS26	US 8025-T30P	13.0	M 8	24.2	SSN 250620	MS 8020	SDR T30P	HXK 5
SS38	US 8025-T30P	13.0	M 8	24.2	SSN 380620	MS 8020	SDR T30P	HXK 5

DKH(RL)



External Tool Holder Shank for KHP/KHS Heavy Turning Cartridges

Dovetailed Right/Left hand modular tool shank for KHP/KHS cartridges. Suited for heavy turning applications. Body treated for longer tool life.

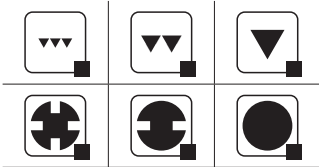
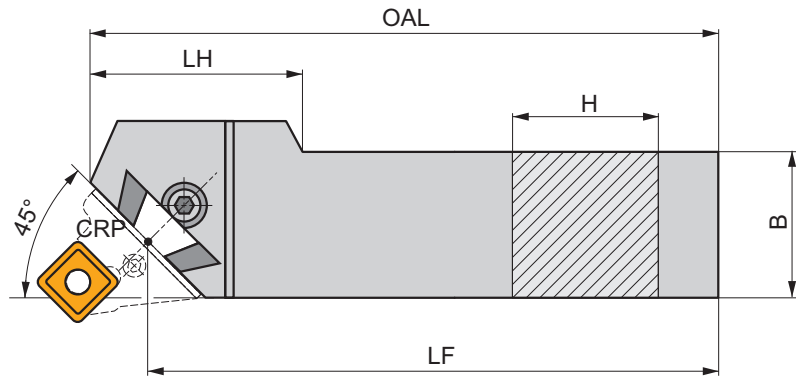
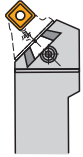

Product	H	B	LF	OAL	LH	kg		
	(mm)	(mm)	(mm)	(mm)	(mm)			
R DKHR 4050 V	40	50	400	425	100.0	7.10	GI098	DKH10
	50	60	450	475	110.0	11.30	GI098	DKH10
	60	80	450	485	90.0	19.65	GI098	DKH10
L DKHL 4050 V	40	50	400	425	100.0	7.10	GI098	DKH10
	50	60	450	475	110.0	11.30	GI098	DKH10
	60	80	450	485	90.0	19.28	GI098	DKH10

GI098	KHP	KHS

DKH10	SR 14	HXK 10

STAC(RL) EXT



PRAMET



External Screw Lock Tool Holder with 91° Cutting Angle for TC.. Inserts

External Right/Left hand tool holder for screw type positive TC.. inserts. Suited for external longitudinal shoulder, taper and chamfer turning and usable for sliding head machines. Body treated for longer tool life.

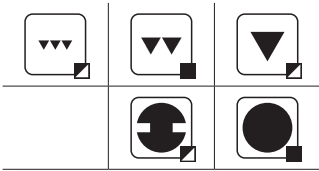
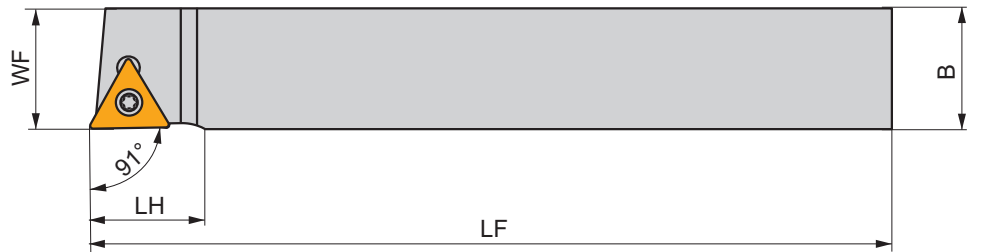
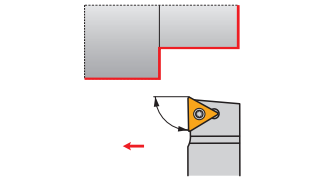

Product	H (mm)	B (mm)	HF (mm)	WF (mm)	LF (mm)	LH (mm)	LAMS (°)	GAMO (°)	kg		
R STACR 1212 K 11-S	12	12	12	12	125	15.2	0	0	0.14	GI056	S01
STACR 1616 K 11-S	16	16	16	16	125	15.2	0	0	0.25	GI056	S01
L STACL 1212 K 11-S	12	12	12	12	125	15.2	0	0	0.14	GI056	S01
STACL 1616 K 11-S	16	16	16	16	125	15.2	0	0	0.25	GI056	S01

	GI056		TC.. 1102..
--	-------	--	-------------

	S01		US 2506-T07P		0.9		M 2.5		6.3		FLAG T07P
--	-----	--	--------------	--	-----	--	-------	--	-----	--	-----------

STFC(RL) EXT



PRAMET



Ext. Screw Lock Tool Holder, 91° (Face Turning) Cutting Angle for TC.. Inserts

External Right/Left hand tool holder for screw type positive TC.. inserts. Suited for external face turning with shoulder and chamfer turning. Body treated for longer tool life.

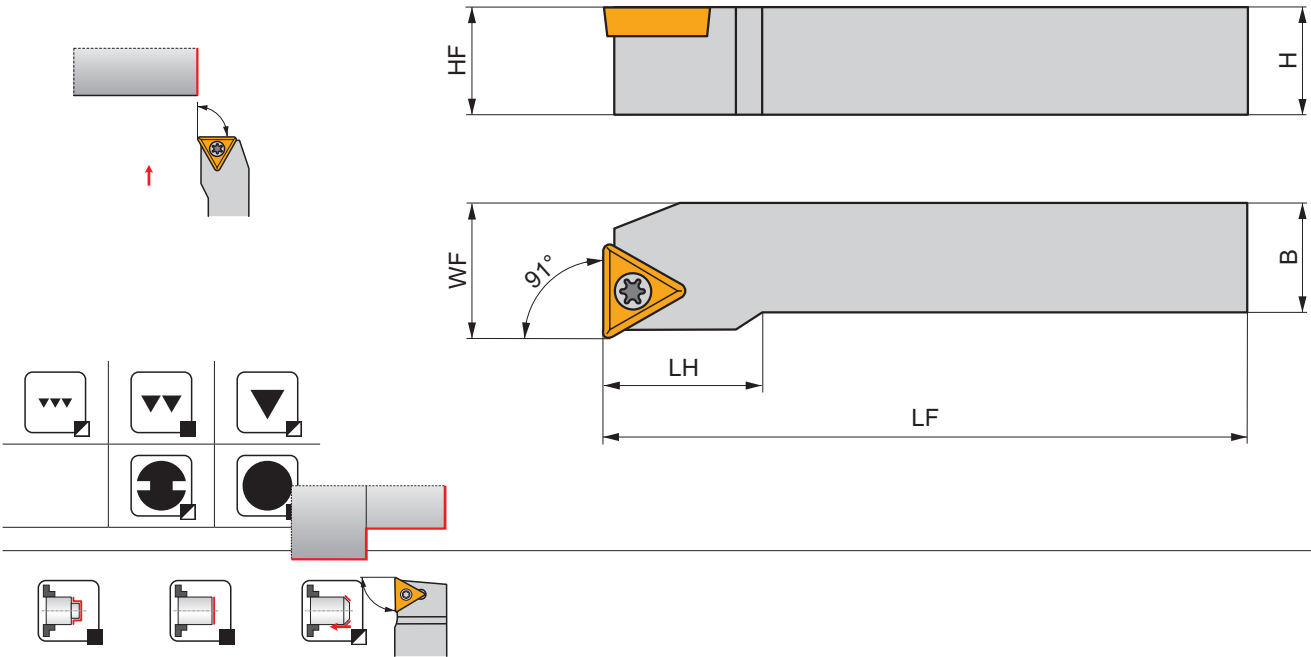

Product	H	B	HF	WF	LF	LH	LAMS	GAMO	kg	GI	ST
	(mm)	(mm)	(mm)	(mm)	(mm)	(mm)	(°)	(°)			
R STFCR 1616 H 11	16	16	16	20	100	18.0	0	0	0.20	GI056	S01
STFCR 2020 K 16-M-A	20	20	20	25	125	25.0	0	0	0.40	GI016	ST10
STFCR 2525 M 16-M-A	25	25	25	32	150	25.0	0	0	0.75	GI016	ST10
L STFCL 1616 H 11	16	16	16	20	100	18.0	0	0	0.22	GI056	S01
STFCL 2020 K 16-M-A	20	20	20	25	125	25.0	0	0	0.40	GI016	ST10
STFCL 2525 M 16-M-A	25	25	25	32	150	25.0	0	0	0.75	GI016	ST10

GI	TC..
GI016	TC.. 16T3..
GI056	TC.. 1102..

ST	US	Nm	M	mm	STN	MS	FLAG	HXK
S01	US 2506-T07P	0.9	M 2.5	6.3	-	-	FLAG T07P	-
ST10	US 3510-T15P	3.0	M 3.5	10.6	STN 160308	MS 3510	FLAG T15P	HXK 3.5

STFC(RL)-A EXT

P
M
K
N
S
H

PRAMET

S



Ext. Screw Lock Tool Holder, 90° (Face Turning) Cutting Angle for TC.. Inserts

External Right/Left hand tool holder for screw type positive TC.. inserts. Suited for left and right-sided external face turning with shoulder and chamfer turning. Body treated for longer tool life.

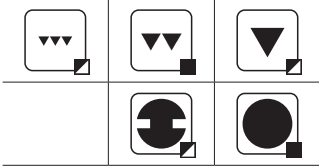
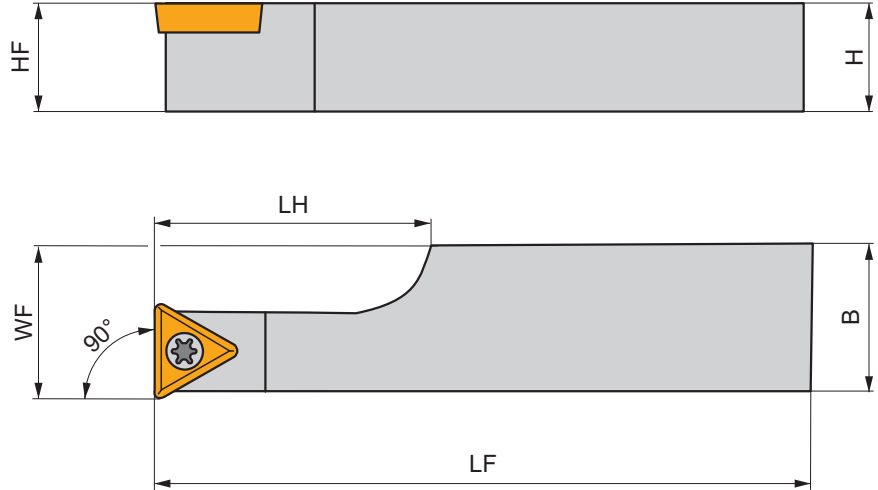
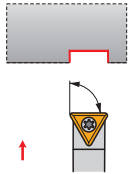

Product	H (mm)	B (mm)	HF (mm)	WF (mm)	LF (mm)	LH (mm)	LAMS (°)	GAMO (°)	kg		
R STFCR 2020 K 11-A	20	20	20	25	125	21.3	0	0	0.37	GI056	ST21
L STFCL 2020 K 11-A	20	20	20	25	125	21.3	0	0	0.36	GI056	ST21

	GI056		TC.. 1102..
--	-------	--	-------------

	ST21		5513 020-03		0.8		M 2.5		6.5		PT-8001
--	------	--	-------------	--	-----	--	-------	--	-----	--	---------

STJC(RL) EXT

P
M
K
N
S
H

PRAMET

S



External Screw Lock Tool Holder with 93° Cutting Angle for TC.. Inserts

External Right/Left hand tool holder for screw type positive TC.. inserts. Suited for external longitudinal turning with shoulder, taper and chamfer turning. Body treated for longer tool life.

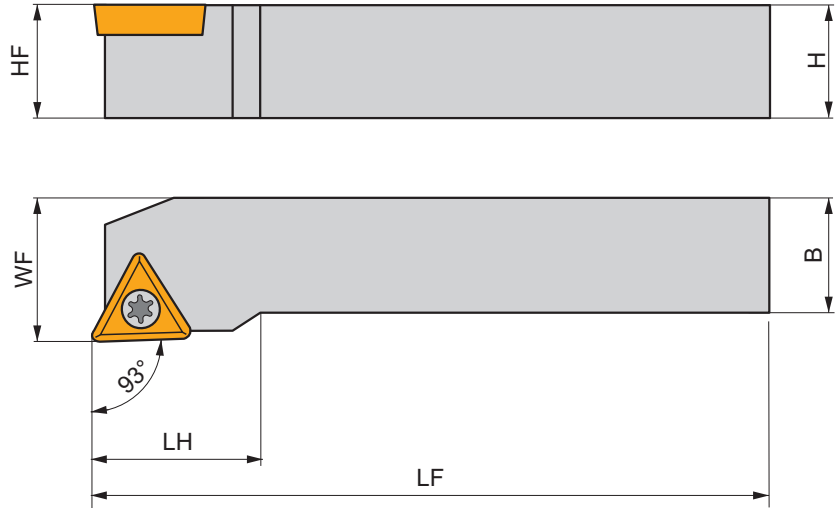
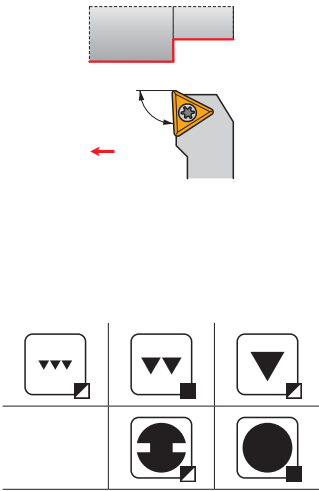

Product	H (mm)	B (mm)	HF (mm)	WF (mm)	LF (mm)	LH (mm)	LAMS (°)	GAMO (°)	kg		
R STJCR 1616 H 11	16	16	16	20	100	18.0	0	0	0.22	GI056	S01
STJCR 2020 K 16-M-A	20	20	20	25	125	25.0	0	0	0.43	GI016	ST10
STJCR 2525 M 16-M-A	25	25	25	32	150	25.0	0	0	0.76	GI016	ST10
L STJCL 1616 H 11	16	16	16	20	100	18.0	0	0	0.22	GI056	S01
STJCL 2020 K 16-M-A	20	20	20	25	125	25.0	0	0	0.43	GI016	ST10
STJCL 2525 M 16-M-A	25	25	25	32	150	25.0	0	0	0.75	GI016	ST10

GI016	TC.. 16T3..
GI056	TC.. 1102..

S01	US 2506-T07P	0.9	M 2.5	6.3	—	—	FLAG T07P	—
ST10	US 3510-T15P	3.0	M 3.5	10.6	STN 160308	MS 3510	FLAG T15P	HXK 3.5

STFC(RL) INT

P
M
K
N
S
H

PRAMET

S



Internal Screw Lock Boring Bar with 91° Cutting Angle for TC.. Inserts

Internal Right/Left hand boring bar, through coolant available, 91° cutting angle for screw type TC.. inserts. Suited for internal taper and longitudinal turning with shoulder and chamfer turning. Body treated for longer tool life.

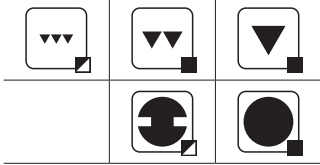
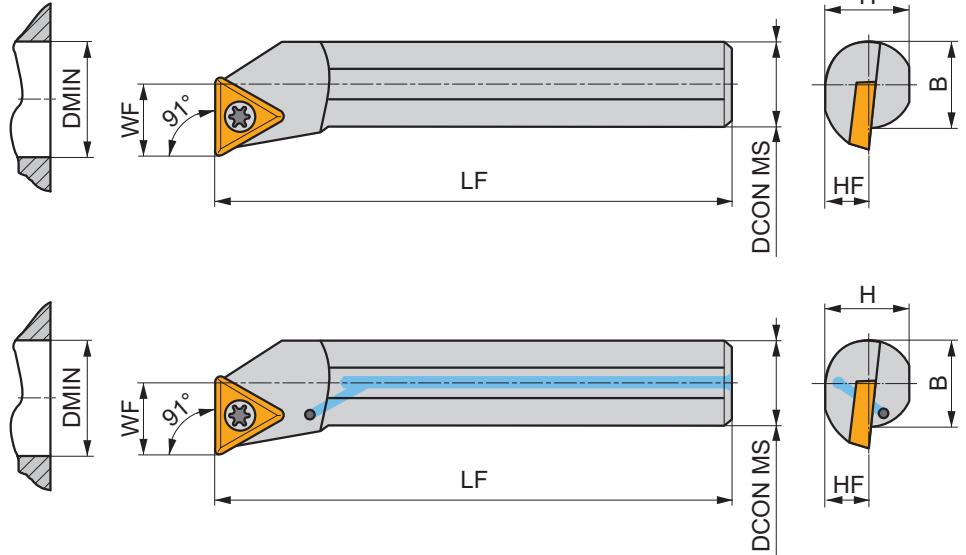
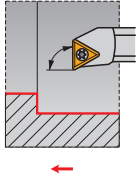

Product	DCON MS	DMIN	WF	H	B	LF	LAMS	GAMO				
	(mm)	(mm)	(mm)	(mm)	(mm)	(mm)	(°)	(°)				
R A06F-STFCR 06	6	8.5	4.5	5	-	80	-12	0	✓	0.02	GI217	ST12
A08H-STFCR 06	8	11	5.9	7	-	100	-10	0	✓	0.05	GI217	ST13
A10K-STFCR 09	10	13	7	9	-	125	-9	0	✓	0.06	GI218	ST14
A12M-STFCR 09	12	16	9	11	-	150	-6.5	0	✓	0.12	GI218	ST14
S10H-STFCR 11	10	13	7	9	9.5	100	-10	0	-	0.08	GI056	S02
A12M-STFCR 11	12	16	9	11	11.5	150	-10	0	✓	0.14	GI056	S01
S12K-STFCR 11	12	16	9	11	11.5	125	-7	0	-	0.13	GI056	S01
A16R-STFCR 11	16	20	11	14.5	15	200	-7	0	✓	0.30	GI056	S01
S16M-STFCR 11	16	20	11	14.5	15	150	-7	0	-	0.24	GI056	S01
A20S-STFCR 11	20	25	13	18	18.5	250	-7	0	✓	0.53	GI056	S01
S20Q-STFCR 11	20	25	13	18	18.5	180	-7	0	-	0.40	GI056	S01
A25R-STFCR 16	25	32	17	23	23	200	-3	0	✓	0.66	GI016	S08
S25T-STFCR 16	25	32	17	23	23	300	-3	0	-	1.08	GI016	S08
A32S-STFCR 16	32	40	22	30	30	250	-10	0	✓	1.35	GI016	ST10
S32U-STFCR 16-A	32	40	22	30	30	350	-10	0	-	2.10	GI016	ST10
L A06F-STFCL 06	6	8.5	4.5	5	-	80	-12	0	✓	0.03	GI217	ST12
A08H-STFCL 06	8	11	5.9	7	-	100	-10	0	✓	0.05	GI217	ST13
A10K-STFCL 09	10	13	7	9	-	125	-9	0	✓	0.06	GI218	ST14
A12M-STFCL 09	12	16	9	11	-	150	-6.5	0	✓	0.03	GI218	ST14
S10H-STFCL 11	10	13	7	9	9.5	100	-10	0	-	0.06	GI056	S02
A12M-STFCL 11	12	16	9	11	11.5	150	-10	0	✓	0.12	GI056	S01
S12K-STFCL 11	12	16	9	11	11.5	125	-7	0	-	0.12	GI056	S01
A16R-STFCL 11	16	20	11	14.5	15	200	-7	0	✓	0.00	GI056	S01
S16M-STFCL 11	16	20	11	14.5	15	150	-7	0	-	0.24	GI056	S01
A20S-STFCL 11	20	25	13	18	18.5	250	-7	0	✓	0.00	GI056	S01
S20Q-STFCL 11	20	25	13	18	18.5	180	-7	0	-	0.42	GI056	S01
A25R-STFCL 16	25	32	17	23	23	200	-3	0	✓	0.00	GI016	S08

Product	D CON MS	D MIN	W F	H	B	L F	L A M S	G A M O				
	(mm)	(mm)	(mm)	(mm)	(mm)	(mm)	(°)	(°)		kg		
L S25T-STFCL 16	25	32	17	23	23	300	-3	0	-	1.08	GI016	S08
A32S-STFCL 16	32	40	22	30	30	250	-10	0	✓	1.36	GI016	ST10
S32U-STFCL 16-A	32	40	22	30	30	350	-10	0	-	2.06	GI016	ST10

GI016	TC.. 16T3..
GI056	TC.. 1102..
GI217	TC.. 06T1..
GI218	TC.. 0902..

S01	US 2506-T07P	0.9	M 2.5	6.3	-	-	FLAG T07P	-	-
S02	US 2505-T07P	0.9	M 2.5	5.2	-	-	FLAG T07P	-	-
S08	US 3510-T15P	3.0	M 3.5	10.6	-	-	FLAG T15P	-	-
ST10	US 3510-T15P	3.0	M 3.5	10.6	STN 160308	MS 3510	FLAG T15P	HXK 3.5	-
ST12	5513 020-28	0.6	M 2	4.2	-	-	-	-	PT-8000
ST13	5513 020-27	0.6	M 2	4.9	-	-	-	-	PT-8000
ST14	5513 020-05	0.8	M 2.2	6.4	-	-	-	-	PT-8001

STFC(RL)-E INT

P M K N S H

PRAMET

S



Internal Carbide Screw Lock Boring Bar with 91° Cutting Angle for TC.. Inserts

Internal Right/Left hand carbide boring bar, through coolant, with 91° cutting angle for screw type TC.. inserts. For internal taper and longitudinal turning with shoulder and chamfer turning. For tool overhang >3xD.

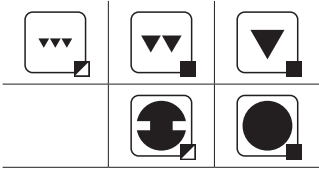
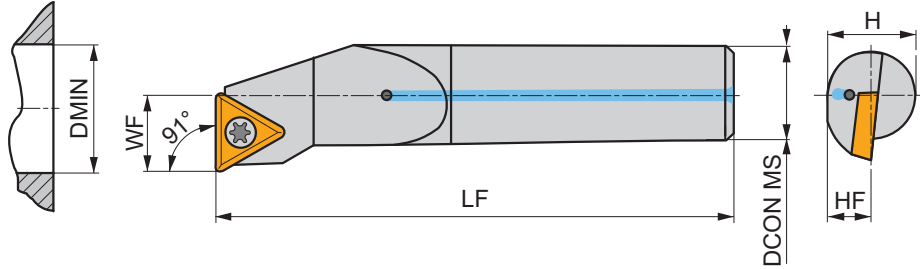
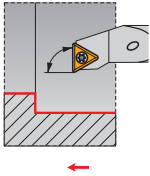

Product	DCON MS	DMIN	WF	H	HF	LF	LAMS	GAMO					
	(mm)	(mm)	(mm)	(mm)	(mm)	(mm)	(°)	(°)					
R	E06H-STFCR 06-R	6	8.5	4.5	6	3	100	-10	0	✓	0.05	GI217	ST22
	E08K-STFCR 06-R	8	11	5.9	8	4	125	-10	0	✓	0.09	GI217	ST23
	E10M-STFCR 09-R	10	13	7	10	5	150	-8	0	✓	0.15	GI218	ST24
	E12Q-STFCR 09-R	12	16	9	12	6	180	-6	0	✓	0.26	GI218	ST24
E16R-STFCR 11-R	16	20	11	16	8	200	-5	0	✓	0.48	GI056	ST21	
L	E06H-STFCL 06-R	6	8.5	4.5	6	3	100	-10	0	✓	0.05	GI217	ST22
	E08K-STFCL 06-R	8	11	5.9	8	4	125	-10	0	✓	0.09	GI217	ST23
	E10M-STFCL 09-R	10	13	7	10	5	150	-8	0	✓	0.15	GI218	ST24
	E12Q-STFCL 09-R	12	16	9	12	6	180	-6	0	✓	0.26	GI218	ST24
	E16R-STFCL 11-R	16	20	11	16	8	200	-5	0	✓	0.48	GI056	ST21

GI056	TC.. 1102..
GI217	TC.. 06T1..
GI218	TC.. 0902..

ST21	5513 020-03	0.8	M 2.5	6.5	PT-8001
ST22	5513 020-28	0.6	M 2	4.2	PT-8000
ST23	5513 020-27	0.6	M 2	4.9	PT-8000
ST24	5513 020-05	0.8	M 2.2	6.4	PT-8001

SVHB(C)(RL) EXT

P
M
K
N
S
H

PRAMET

S



Ext. Screw Lock Tool Holder with 107.5° Cutting Angle for VB/VC.. Inserts

External Right/Left hand tool holder for screw type positive VB.. and VC.. inserts. Suited for external face and longitudinal turning with shoulder, taper, face and longitudinal copy turning up to 35° and chamfer turning. Body treated for longer tool life.

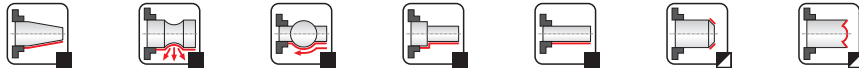
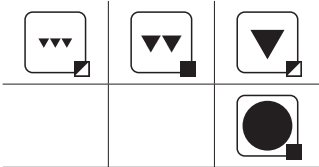
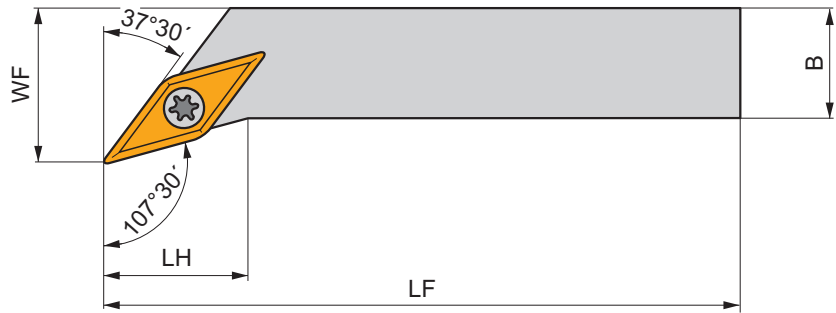
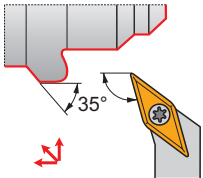

Product	H	B	HF	WF	LF	LH	LAMS	GAMO	kg		
	(mm)	(mm)	(mm)	(mm)	(mm)	(mm)	(°)	(°)			
R SVHBR 1616 H 11	16	16	16	20	100	14.0	0	0	0.20	G1194	S01
SVHCR 2020 K 16-M-A	20	20	20	25	125	20.0	0	0	0.39	G1017	SV10
SVHCR 2525 M 16-M-A	25	25	25	32	150	20.0	0	0	0.71	G1017	SV10
L SVHBL 1616 H 11	16	16	16	20	100	14.0	0	0	0.19	G1194	S01
SVHCL 2020 K 16-M-A	20	20	20	25	125	20.0	0	0	0.40	G1017	SV10
SVHCL 2525 M 16-M-A	25	25	25	32	150	20.0	0	0	0.07	G1017	SV10

G1017	VB.. 1604..	VC.. 1604..
G1194	VB.. 1103..	VC.. 1103..

S01	US 2506-T07P	0.9	M 2.5	6.3	—	—	FLAG T07P	—
SV10	US 3512-T15P	3.0	M 3.5	12.6	SVN 160304	MS 3510	FLAG T15P	HXK 3.5

SVJB(C)(RL) EXT



PRAMET







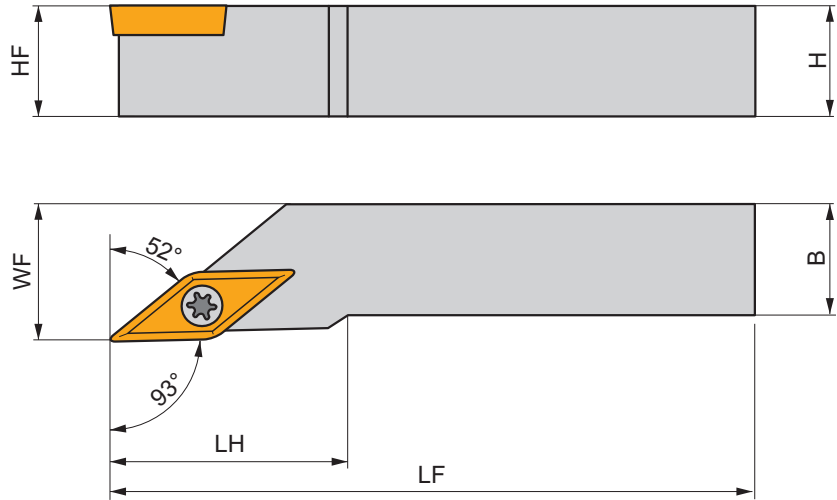
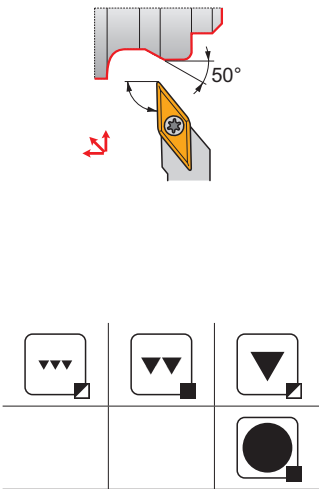



External Screw Lock Tool Holder with 93° Cutting Angle for VB/VC.. Inserts

External Right/Left hand tool holder for screw type positive VB.. and VC.. inserts. Suited for external longitudinal shoulder, taper, chamfer and copy turning up to 50° with some usable for sliding head machines. Body treated for longer tool life.



	Product	H	B	HF	WF	LF	LH	LAMS	GAMO	kg	G1	S
		(mm)	(mm)	(mm)	(mm)	(mm)	(mm)	(°)	(°)			
R	SVJBR 1212 F 11	12	12	12	16	80	20.0	0	0	0.09	G1194	S01
	SVJBR 1212 K 11-S	12	12	12	12	125	25.6	0	0	0.13	G1194	S01
	SVJBR 1616 H 11	16	16	16	20	100	20.0	0	0	0.20	G1194	S01
	SVJBR 1616 K 11-S	16	16	16	16	125	25.6	0	0	0.22	G1194	S01
	SVJCR 1212 N 13	12	12	12	16	160	27.0	0	0	0.19	G1211	SV21
	SVJCR 1616 H 13	16	16	16	20	100	30.0	0	0	0.20	G1211	SV21
	SVJCR 2020 K 13	20	20	20	25	125	30.0	0	0	0.37	G1211	SV22
	SVJCR 2020 K 16-M-A	20	20	20	25	125	28.0	0	0	0.35	G1017	SV10
	SVJCR 2525 M 13	25	25	25	32	150	30.0	0	0	0.67	G1211	SV22
	SVJCR 2525 M 16-M-A	25	25	25	32	150	32.0	0	0	0.66	G1017	SV10
	SVJCR 3225 P 16-M-A	32	25	32	32	170	32.0	0	0	0.99	G1017	SV10
L	SVJBL 1212 F 11	12	12	12	16	80	20.0	0	0	0.09	G1194	S01
	SVJBL 1212 K 11-S	12	12	12	12	125	25.6	0	0	0.13	G1194	S01
	SVJBL 1616 H 11	16	16	16	20	100	20.0	0	0	0.19	G1194	S01
	SVJBL 1616 K 11-S	16	16	16	16	125	25.6	0	0	0.22	G1194	S01
	SVJCL 1212 N 13	12	12	12	16	160	27.0	0	0	0.19	G1211	SV21
	SVJCL 1616 H 13	16	16	16	20	100	30.0	0	0	0.20	G1211	SV21
	SVJCL 2020 K 13	20	20	20	25	125	30.0	0	0	0.37	G1211	SV22
	SVJCL 2020 K 16-M-A	20	20	20	25	125	28.0	0	0	0.38	G1017	SV10
	SVJCL 2525 M 13	25	25	25	32	150	30.0	0	0	0.67	G1211	SV22
	SVJCL 2525 M 16-M-A	25	25	25	32	150	32.0	0	0	0.68	G1017	SV10
	SVJCL 3225 P 16-M-A	32	25	32	32	170	32.0	0	0	0.99	G1017	SV10

G1017	VB.. 1604..	VC.. 1604..
G1194	VB.. 1103..	VC.. 1103..
G1211	-	VC.. 1303..

		 Nm						
S01	US 2506-T07P	0.9	M 2.5	6.3	–	–	FLAG T07P	–
SV10	US 3512-T15P	3.0	M 3.5	12.6	SVN 160304	MS 3510	FLAG T15P	HXK 3.5
SV21	5513 020-24	1.5	M 3	8.5	–	–	PT-8002	–
SV22	DVF 0573	1.5	M 3	10.3	DAP 0331	DVT 0332	PT-8002	174.1-870

SVPB(C)(RL) EXT



PRAMET

S



External Screw Lock Tool Holder, 117.5° Cutting Angle for VB/VC.. Inserts

External Right/Left hand tool holder for screw type positive VB.. and VC.. inserts. Suited for external face and longitudinal turning with shoulder, taper, face copy turning up to 25° and chamfer turning. Body treated for longer tool life.

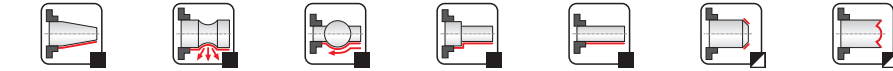
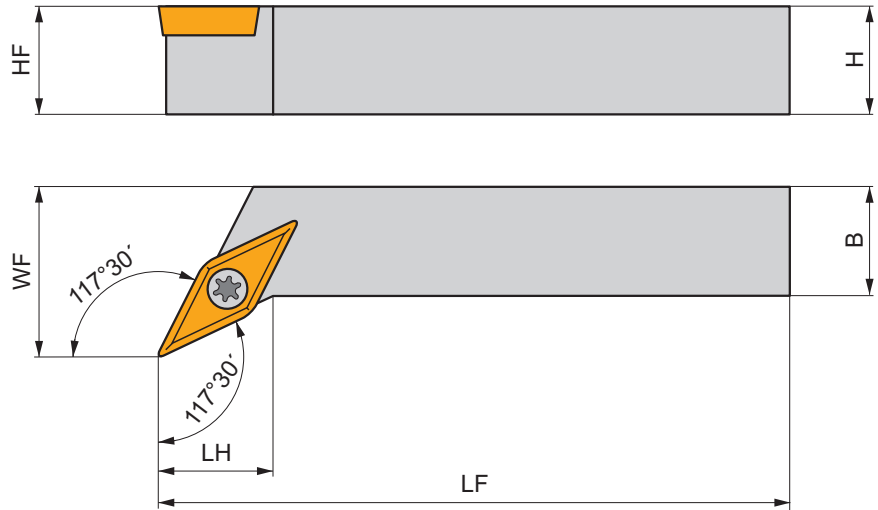
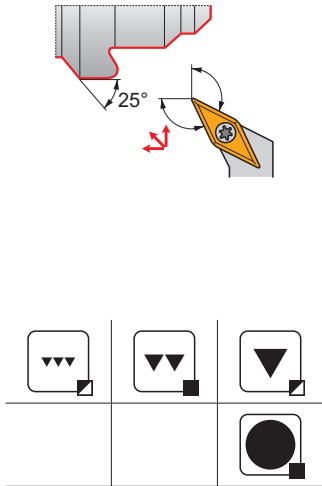

Product	H (mm)	B (mm)	HF (mm)	WF (mm)	LF (mm)	LH (mm)	LAMS (°)	GAMO (°)	kg	GI	SV
R SVPBR 1616 H 11	16	16	16	20	100	12.0	0	0	0.20	GI194	SO1
SVPBR 2020 K 11	20	20	20	25	125	12.0	0	0	0.40	GI194	SO1
SVPCR 2020 K 16-M-A	20	20	20	25	125	20.0	0	0	0.40	GI017	SV10
SVPCR 2525 M 16-M-A	25	25	25	32	150	25.0	0	0	0.73	GI017	SV10
SVPCR 3225 P 16-M-A	32	25	32	32	170	25.0	0	0	1.03	GI017	SV10
L SVPBL 1616 H 11	16	16	16	20	100	12.0	0	0	0.20	GI194	SO1
SVPBL 2020 K 11	20	20	20	25	125	12.0	0	0	0.39	GI194	SO1
SVPCL 2020 K 16-M-A	20	20	20	25	125	20.0	0	0	0.40	GI017	SV10
SVPCL 2525 M 16-M-A	25	25	25	32	150	25.0	0	0	0.70	GI017	SV10
SVPCL 3225 P 16-M-A	32	25	32	32	170	25.0	0	0	1.10	GI017	SV10

GI	VB..	VC..
GI017	VB.. 1604..	VC.. 1604..
GI194	VB.. 1103..	VC.. 1103..

SO	US	Nm	M	mm	mm	mm	mm	mm	mm
SO1	US 2506-T07P	0.9	M 2.5	6.3	-	-	FLAG T07P	-	-
SV10	US 3512-T15P	3.0	M 3.5	12.6	SVN 160304	MS 3510	FLAG T15P	HXK 3.5	-

SVVB(C)N EXT



PRAMET



External Screw Lock Tool Holder, 72.5° Cutting Angle for VB/VC.. Inserts

External neutral tool holder for screw type positive VB.. and VC.. inserts. Suited for external longitudinal turning without shoulder, taper, copy turning up to 72.5° and chamfer turning. Body treated for longer tool life.

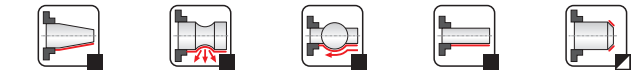
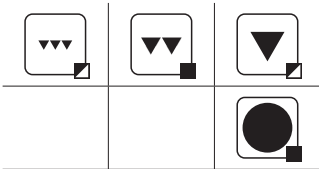
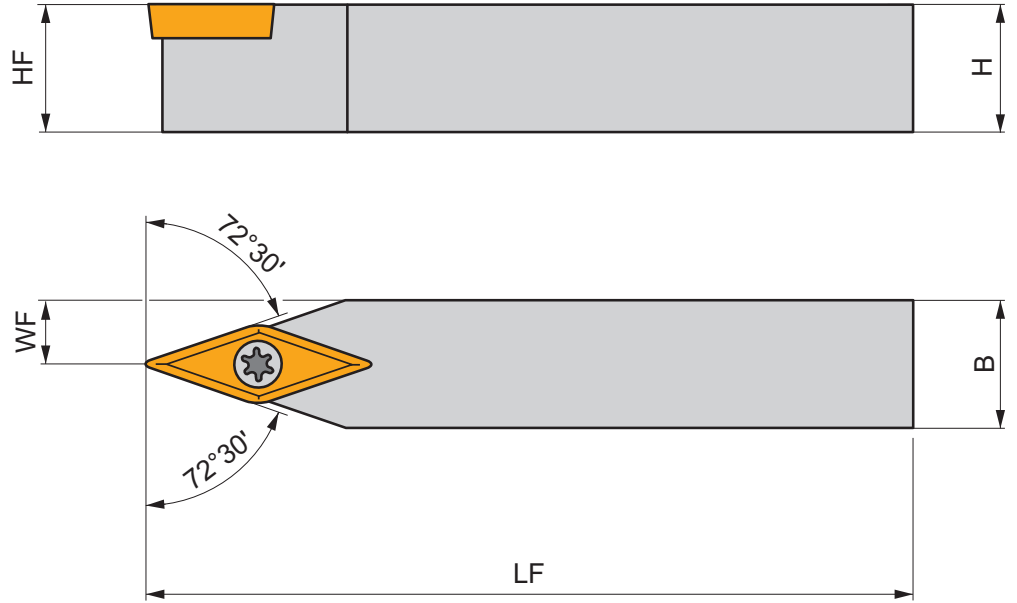
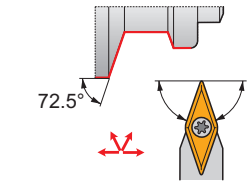

Product	H (mm)	B (mm)	HF (mm)	WF (mm)	LF (mm)	LH (mm)	LAMS (°)	GAMO (°)	kg	GI	SV
SVVBN 1212 F 11	12	12	12	6	80	-	0	0	0.10	GI194	S01
SVVBN 1616 H 11	16	16	16	8	100	-	0	0	0.20	GI194	S01
SVVBN 2020 K 11	20	20	20	10	125	-	0	0	0.36	GI194	S01
SVVCN 1212 N 13	12	12	12	6	160	-	0	0	0.19	GI211	SV21
SVVCN 1616 H 13	16	16	16	8	100	-	0	0	0.20	GI211	SV21
SVVCN 2020 K 13	20	20	20	10	125	-	0	0	0.36	GI211	SV22
SVVCN 2525 M 13	25	25	25	12.5	150	-	0	0	0.66	GI211	SV22
SVVCN 2020 K 16-M-A	20	20	20	10	125	-	0	0	0.34	GI017	SV10
SVVCN 2525 M 16-M-A	25	25	25	12.5	150	-	0	0	0.67	GI017	SV10
SVVCN 3225 P 16-M-A	32	25	32	12.5	170	-	0	0	0.97	GI017	SV10

GI	VB..	VC..
GI017	VB.. 1604..	VC.. 1604..
GI194	VB.. 1103..	VC.. 1103..
GI211	-	VC.. 1303..

SV	US	Nm	M	mm	SVN	MS	PT	mm
S01	US 2506-T07P	0.9	M 2.5	6.3	-	-	FLAG T07P	-
SV10	US 3512-T15P	3.0	M 3.5	12.6	SVN 160304	MS 3510	FLAG T15P	HXK 3.5
SV21	5513 020-24	1.5	M 3	8.5	-	-	PT-8002	-
SV22	DVF 0573	1.5	M 3	10.3	DAP 0331	DVT 0332	PT-8002	174.1-870

SVXB(C)(RL) EXT

P
M
K
N
S
H

PRAMET

S



External Screw Lock Tool Holder 98/113° Cutting Angle for VB/VC.. Inserts

External Right/Left hand tool holder for screw type positive VB.. and VC.. inserts. Suited for external longitudinal turning with shoulder, taper, copy turning up to 30° and chamfer turning. Body treated for longer tool life.

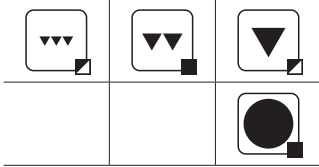
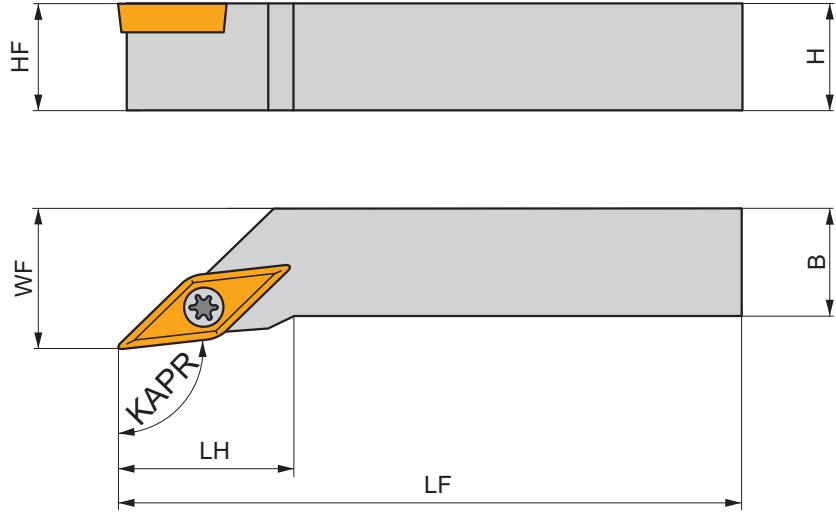
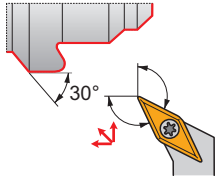

Product	H	B	HF	WF	LF	LH	KAPR	LAMS	GAMO	kg		
	(mm)	(mm)	(mm)	(mm)	(mm)	(mm)	(°)	(°)	(°)			
R	SVXBR 1212 F 11	12	12	12	16	80	20.0	98	0	0	0.09	GI194 S01
	SVXBR 1616 H 11	16	16	16	20	100	14.0	98	0	0	0.19	GI194 S01
	SVXCR 2020 K 13	20	20	20	25	125	12.0	113	0	0	0.41	GI211 SV22
	SVXCR 2020 K 16-M-A	20	20	20	25	125	28.0	98	0	0	0.38	GI017 SV10
	SVXCR 2525 M 16-M-A	25	25	25	32	150	32.0	98	0	0	0.68	GI017 SV10
	SVXCR 3225 P 16-M-A	32	25	32	32	170	32.0	98	0	0	1.00	GI017 SV10
L	SVXBL 1212 F 11	12	12	12	16	80	20.0	98	0	0	0.09	GI194 S01
	SVXBL 1616 H 11	16	16	16	20	100	14.0	98	0	0	0.19	GI194 S01
	SVXCL 2020 K 13	20	20	20	25	125	12.0	113	0	0	0.38	GI211 SV22
	SVXCL 2020 K 16-M-A	20	20	20	25	125	28.0	98	0	0	0.38	GI017 SV10
	SVXCL 2525 M 16-M-A	25	25	25	32	150	32.0	98	0	0	0.69	GI017 SV10
	SVXCL 3225 P 16-M-A	32	25	32	32	170	32.0	98	0	0	0.99	GI017 SV10

GI017	VB.. 1604..	VC.. 1604..
GI194	VB.. 1103..	VC.. 1103..
GI211	-	VC.. 1303..

S01	US 2506-T07P	0.9	M 2.5	6.3	-	-	FLAG T07P	-
SV10	US 3512-T15P	3.0	M 3.5	12.6	SVN 160304	MS 3510	FLAG T15P	HXK 3.5
SV22	DVF 0573	1.5	M 3	10.3	DAP 0331	DVT 0332	PT-8002	174.1-870

C.-SVHB(RL) EXT

P
M
K
N
S
H

PRAMET

S



Ext. PSC Quick Change Tool, Screw Lock, 107.5° Cutting Angle, VB/VC.. Inserts

External Right/Left hand tool, through coolant, for screw type positive VB.. and VC.. inserts. Suited for external longitudinal turning with shoulder, taper, copy turning up to 35° and chamfer turning. Polygon Shank Coupling. Body treated for longer tool life.

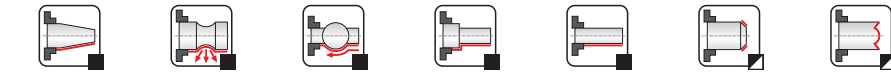
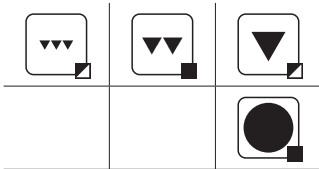
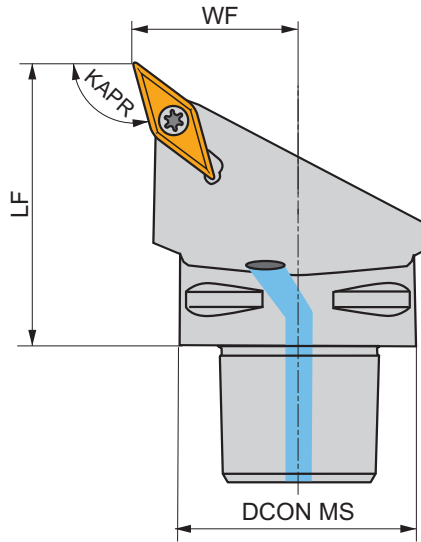
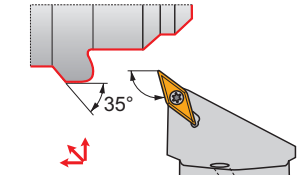

Product	DCON MS (mm)	WF (mm)	LF (mm)	KAPR (°)	LAMS (°)	GAMO (°)		kg		
R C4-SVHBR-27050-16	40	27	50	107.5	0	0	✓	0.35	GI017	C-SV16S-1
C5-SVHBR-35060-16	50	35	60	107.5	0	0	✓	0.64	GI017	C-SV16S-2
C6-SVHBR-45065-16	63	45	65	107.5	0	0	✓	1.13	GI017	C-SV16S-2
L C4-SVHBL-27050-16	40	27	50	107.5	0	0	✓	0.35	GI017	C-SV16S-1
C5-SVHBL-35060-16	50	35	60	107.5	0	0	✓	0.64	GI017	C-SV16S-2
C6-SVHBL-45065-16	63	45	65	107.5	0	0	✓	1.12	GI017	C-SV16S-2

GI017	VB.. 1604..	VC.. 1604..

C-SV16S-1	US 2001-T15P	3.0	M 3.5	12.1	SVS 270-01	MS 9001	FLAG T15P/3,5	CN 034-01
C-SV16S-2	US 2001-T15P	3.0	M 3.5	12.1	SVS 270-01	MS 9001	FLAG T15P/3,5	CN 034-02

C.-SVJB(RL) EXT

P
M
K
N
S
H

PRAMET

S



Ext. PSC Quick Change Tool, Screw Lock, 93° Cutting Angle for VB/VC.. Inserts

External Right/Left hand tool, through coolant, for screw type positive VB.. and VC.. inserts. Suited for external longitudinal turning with shoulder, taper, copy turning up to 50° and chamfer turning. Polygon Shank Coupling. Body treated for longer tool life.

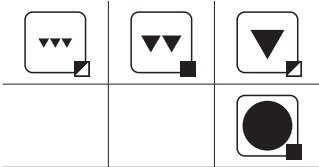
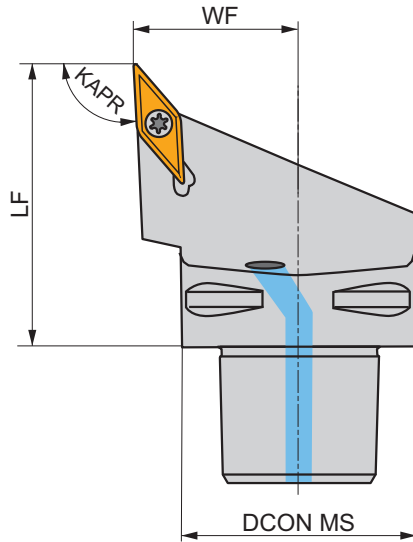
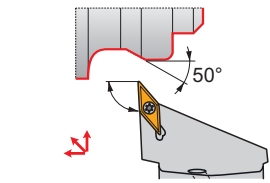

Product	DCON MS (mm)	WF (mm)	LF (mm)	KAPR (°)	LAMS (°)	GAMO (°)		kg		
R C3-SVJBR-22040-11-B1	32	22	40	93	0	0	✓	0.17	GI194	C-SV11
C4-SVJBR-27050-11-B1	40	27	50	93	0	0	✓	0.34	GI194	C-SV11
C4-SVJBR-27050-16	40	27	50	93	0	0	✓	0.35	GI017	C-SV16S-1
C5-SVJBR-35060-16	50	35	60	93	0	0	✓	0.63	GI017	C-SV16S-2
C6-SVJBR-45065-16	63	45	65	93	0	0	✓	1.11	GI017	C-SV16S-2
L C4-SVJBL-27050-16	40	27	50	93	0	0	✓	0.34	GI017	C-SV16S-1
C5-SVJBL-35060-16	50	35	60	93	0	0	✓	0.64	GI017	C-SV16S-2
C6-SVJBL-45065-16	63	45	65	93	0	0	✓	1.11	GI017	C-SV16S-2

GI017	VB.. 1604..	VC.. 1604..
GI194	VB.. 1103..	VC.. 1103..

C-SV11	US 2003-T07P	0.8	M 2.5	6.5	—	—	FLAG T07P	CN 034-01
C-SV16S-1	US 2001-T15P	3.0	M 3.5	12.1	SVS 270-01	MS 9001	FLAG T15P/3,5	CN 034-01
C-SV16S-2	US 2001-T15P	3.0	M 3.5	12.1	SVS 270-01	MS 9001	FLAG T15P/3,5	CN 034-02

C.-SVVBN EXT

P
M
K
N
S
H

PRAMET

S



Ext. PSC Quick Change Tool, Screw Lock, 72.5° Cutting Angle, VB/VC.. Inserts

External neutral tool, through coolant, for screw type positive VB.. and VC.. inserts. Suited for external longitudinal turning without shoulder, taper, copy turning up to 72.5° and chamfer turning. Polygon Shank Coupling. Body treated for longer tool life.

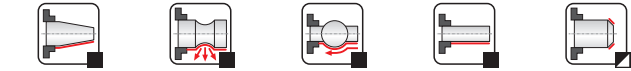
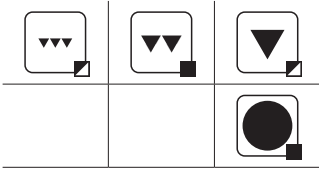
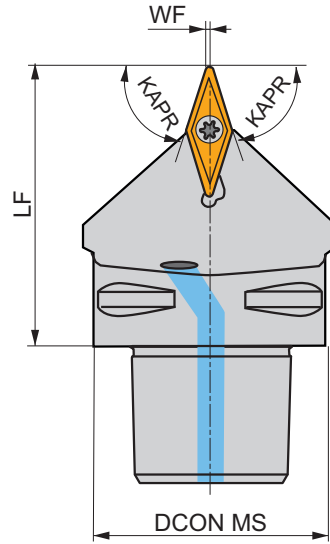
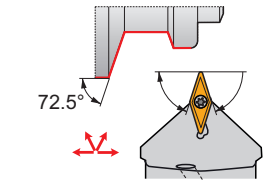

Product	DCON MS (mm)	WF (mm)	LF (mm)	KAPR (°)	LAMS (°)	GAMO (°)		kg		
N C4-SVVBN-00050-16	40	0.6	50	72.5	0	0	✓	0.32	GI017	C-SV16S-1
C5-SVVBN-00060-16	50	0.6	60	72.5	0	0	✓	0.56	GI017	C-SV16S-2
C6-SVVBN-00065-16	63	0.6	65	72.5	0	0	✓	0.99	GI017	C-SV16S-2

GI017	VB.. 1604..	VC.. 1604..

C-SV16S-1	US 2001-T15P	3.0	M 3.5	12.1	SVS 270-01	MS 9001	FLAG T15P/3,5	FLAG T15P/3,5	CN 034-01
C-SV16S-2	US 2001-T15P	3.0	M 3.5	12.1	SVS 270-01	MS 9001	FLAG T15P/3,5	FLAG T15P/3,5	CN 034-02

SVJB(RL) INT

P
M
K
N
S
H

PRAMET

S



Internal Screw Lock Boring Bar with 93° Cutting Angle for VB/VC.. Inserts

Internal Right/Left hand boring bar, through coolant, with 93° cutting angle for screw type VB.. VC.. inserts. Suited for face copy turning under 50°. Body treated for longer tool life.

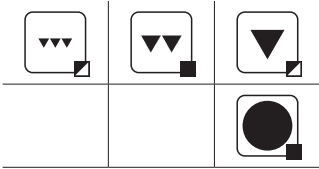
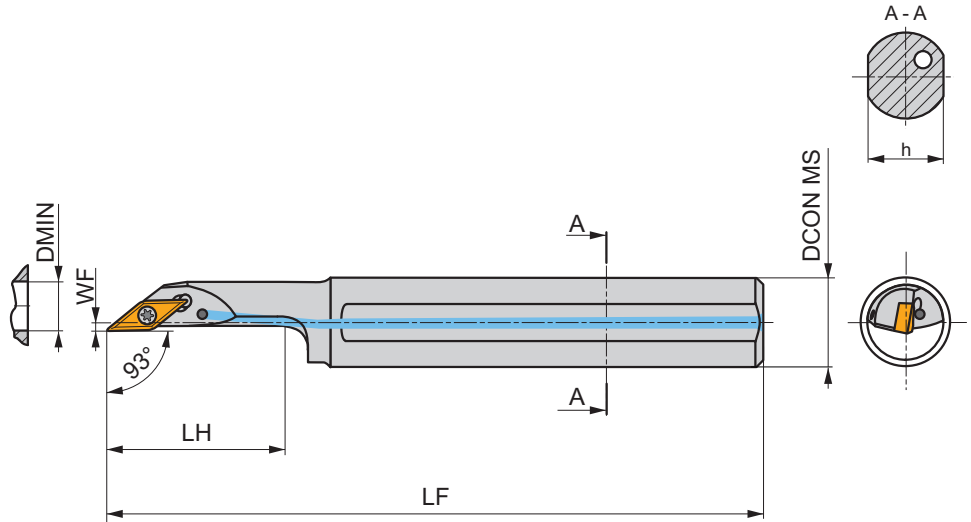
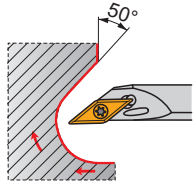

Product	DCON MS	DMIN	WF	H	LF	LH	LAMS	GAMO				
	(mm)	(mm)	(mm)	(mm)	(mm)	(mm)	(°)	(°)				
R A20R-SVJBR 11	20	25	2	18	200	40.0	-5	-5	✓	0.40	G194	S07
	A25S-SVJBR 11	25	32	3.5	23	250	50.0	-5	-5	✓	0.81	G194
L A20R-SVJBL 11	20	25	2	18	200	40.0	-5	-5	✓	0.41	G194	S07
	A25S-SVJBL 11	25	32	3.5	23	250	50.0	-5	-5	✓	0.81	G194

G194	VB.. 1103..	VC.. 1103..

S07	US 2506-T07P	0.9	M 2.5	6.3	FLAG T07P

SVQB(C)(RL) INT



PRAMET

S



Internal Screw Lock Boring Bar with 107.5° Cutting Angle for VB/VC.. Inserts

Internal Right/Left hand boring bar, through coolant available, with 107.5° cutting angle for screw type VB../VC.. inserts. Suited for a wide range of internal turning operations.

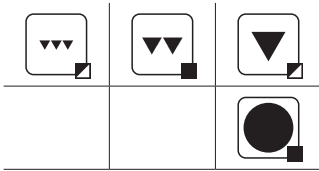
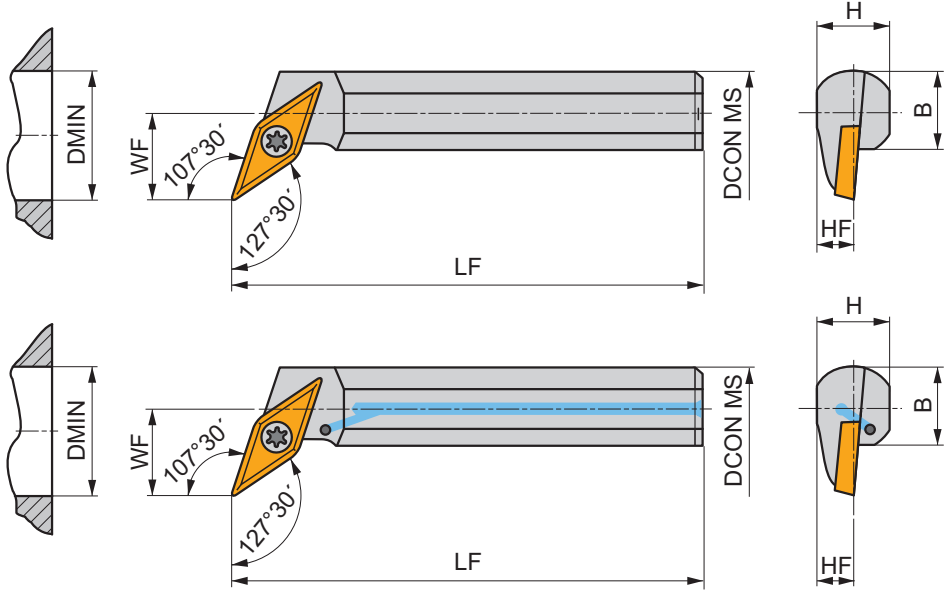
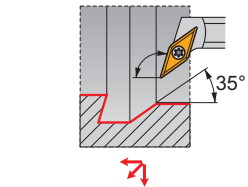

Product	DCON MS	DMIN	WF	H	B	LF	LAMS	GAMO					
	(mm)	(mm)	(mm)	(mm)	(mm)	(mm)	(°)	(°)					
R	A16R-SVQBR 11	16	20	11	14.5	15	200	-5	0	✓	0.33	GI194	S01
	A20S-SVQBR 11	20	25	13	18	18.5	250	-4	0	✓	0.57	GI194	S01
	A16R-SVQCR 13	16	21	11	15	15	200	-6	0	✓	0.29	GI211	SV21
	A20S-SVQCR 13	20	25	13	18	18.5	250	-4	0	✓	0.12	GI211	SV21
	S25T-SVQCR 16	25	32	17	23	23	300	-7	0	-	1.08	GI017	S08
	S32U-SVQCR 16	32	40	22	30	30	350	-5	0	-	2.07	GI017	S08
L	S40V-SVQCR 16-A	40	50	27	38	38	400	-5	0	-	3.80	GI017	SV10
	A16R-SVQBL 11	16	20	11	14.5	15	200	-5	0	✓	0.32	GI194	S01
	A20S-SVQBL 11	20	25	13	18	18.5	250	-4	0	✓	0.57	GI194	S01
	A16R-SVQCL 13	16	21	11	15	15	200	-6	0	✓	0.29	GI211	SV21
	A20S-SVQCL 13	20	25	13	18	18.5	250	-4	0	✓	0.54	GI211	SV21
	S25T-SVQCL 16	25	32	17	23	23	300	-7	0	-	1.08	GI017	S08
S32U-SVQCL 16	32	40	22	30	30	350	-5	0	-	2.07	GI017	S08	
S40V-SVQCL 16-A	40	50	27	38	38	400	-5	0	-	4.10	GI017	SV10	

GI017	VB.. 1604..	VC.. 1604..
GI194	VB.. 1103..	VC.. 1103..
GI211	-	VC.. 1303..

S01	US 2506-T07P	0.9	M 2.5	6.3	-	-	FLAG T07P	-
S08	US 3510-T15P	3.0	M 3.5	10.6	-	-	FLAG T15P	-
SV10	US 3512-T15P	3.0	M 3.5	12.6	SVN 160304	MS 3510	FLAG T15P	HXK 3.5
SV21	5513 020-24	1.5	M 3	8.5	-	-	PT-8002	-

SVUB(C)(RL) INT



PRAMET

S



Internal Screw Lock Boring Bar with 93° Cutting Angle for VB/VC.. Inserts

Internal Right/Left hand boring bar, through coolant available, with 93° cutting angle for screw type VB../VC.. inserts. For a wide range of internal turning operations and copying under 50°. Body treated for longer tool life.

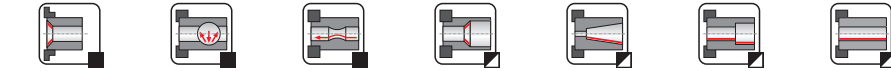
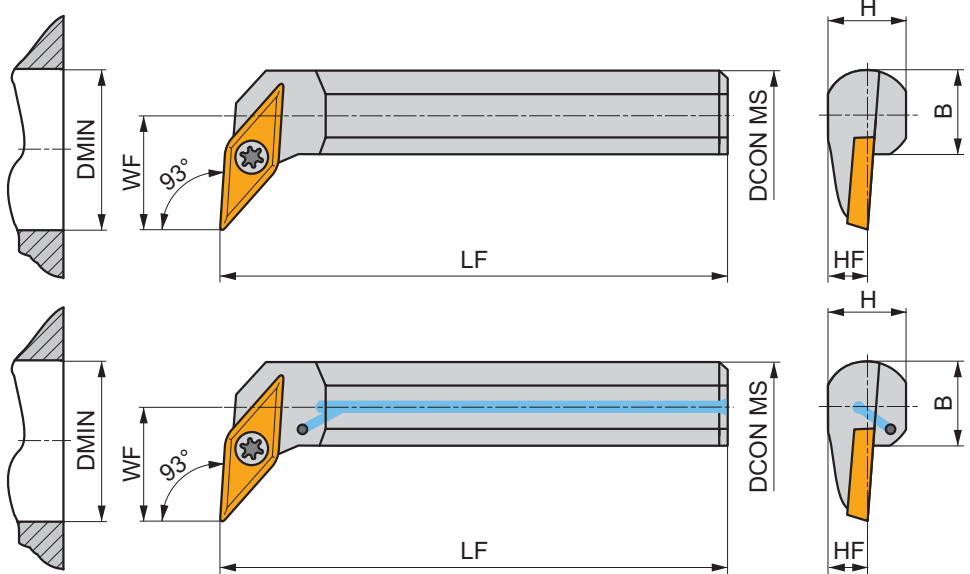
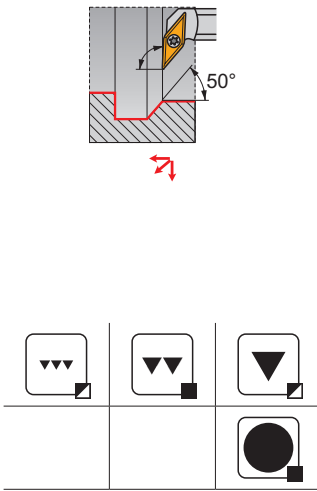

Product	DCON MS	DMIN	WF	H	B	LF	LAMS	GAMO				
	(mm)	(mm)	(mm)	(mm)	(mm)	(mm)	(°)	(°)				
R A16R-SVUBR 11	16	20	11	14.5	15	200	-5	0	✓	0.32	G194	S01
A20S-SVUBR 11	20	25	13	18	18.8	250	-4	0	✓	0.57	G194	S01
A20S-SVUCR 13	20	25	13	19	18.5	250	-4	2	✓	0.54	G1211	SV21
A25T-SVUCR 13	25	32	17	24	23	300	-2	2	✓	0.96	G1211	SV22
A32T-SVUCR 13	32	40	22	30	30	300	-1	2	✓	1.66	G1211	SV22
S25T-SVUCR 16	25	32	17	23	23	300	-7	0	-	1.08	G1017	S08
S32U-SVUCR 16	32	40	22	30	30	350	-5	0	-	2.10	G1017	S08
S40V-SVUCR 16-A	40	50	27	38	38	400	-5	0	-	4.10	G1017	SV10
L A16R-SVUBL 11	16	20	11	14.5	15	200	-5	0	✓	0.32	G194	S01
A20S-SVUBL 11	20	25	13	18	18.5	250	-4	0	✓	0.57	G194	S01
A20S-SVUCL 13	20	25	13	19	18.5	250	-4	2	✓	0.32	G1211	SV21
A25T-SVUCL 13	25	32	17	24	23	300	-2	2	✓	0.96	G1211	SV22
A32T-SVUCL 13	32	40	22	30	30	300	-1	2	✓	1.66	G1211	SV22
S25T-SVUCL 16	25	32	17	23	23	300	-7	0	-	1.09	G1017	S08
S32U-SVUCL 16	32	40	22	30	30	350	-5	0	-	2.10	G1017	S08
S40V-SVUCL 16-A	40	50	27	38	38	400	-5	0	-	4.10	G1017	SV10

G1017	VB.. 1604..	VC.. 1604..
G194	VB.. 1103..	VC.. 1103..
G1211	-	VC.. 1303..

S01	US 2506-T07P	0.9	M 2.5	6.3	-	-	FLAG T07P	-
S08	US 3510-T15P	3.0	M 3.5	10.6	-	-	FLAG T15P	-
SV10	US 3512-T15P	3.0	M 3.5	12.6	SVN 160304	MS 3510	FLAG T15P	HXK 3.5
SV21	5513 020-24	1.5	M 3	8.5	-	-	PT-8002	-
SV22	DVF 0573	1.5	M 3	10.3	DAP 0331	DVT 0332	PT-8002	174.1-870

C.-SVQB(RL) INT

P
M
K
N
S
H

PRAMET

S



Int. PSC Quick Change Tool, Screw Lock, 107.5° Cutting Angle, VB/VC.. Inserts

Internal Right/Left hand tool, through coolant, with 107.5° cutting angle for screw type VB.. or VC.. inserts. Suited for a wide range of internal turning operations. Polygon Shank Coupling with choice of lengths. Body treated for longer tool life.

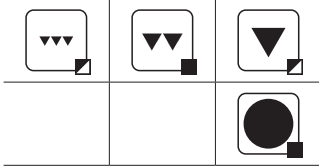
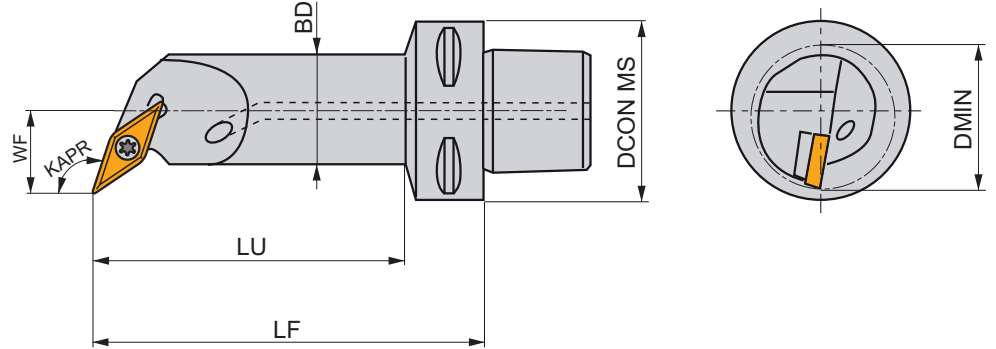
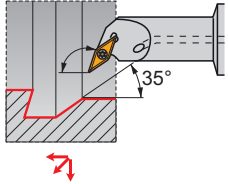

Product	DCON MS	DMIN	WF	LF	LU	BD	KAPR	LAMS	GAMO				
	(mm)	(mm)	(mm)	(mm)	(mm)	(mm)	(°)	(°)	(°)				
R C4-SVQBR-18090-16	40	33	18	90	68	25	107.5	-7.2	0	✓	0.48	GI017	SV16
	C5-SVQBR-18090-16	50	33	18	90	67	25	107.5	-7.2	0	✓	0.67	GI017
L C4-SVQBL-18090-16	40	33	18	90	68	25	107.5	-7.2	0	✓	0.48	GI017	SV16
	C5-SVQBL-18090-16	50	33	18	90	67	25	107.5	-7.2	0	✓	0.68	GI017

GI017	VB.. 1604..	VC.. 1604..

SV16	US 2010-T15P	3.0	M 3.5	10.1	FLAG T15P/3,5

SVAC(RL)-DC EXT

P
M
K
N
S
H

PRAMET

S



Ext. Screw Lock Swiss Style Tool Holder, 90° Cutting Angle for VCGX 13 Inserts

External Right/Left hand tool holder for screw type positive VCGX 13 Swiss style inserts. Suited for external face and longitudinal turning with shoulder, taper, copy turning up to 53° and chamfer turning. Body treated for longer tool life.

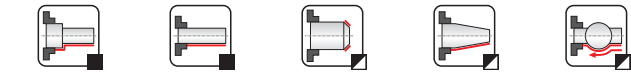
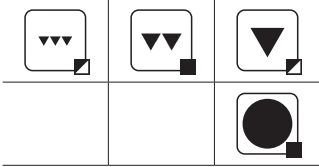
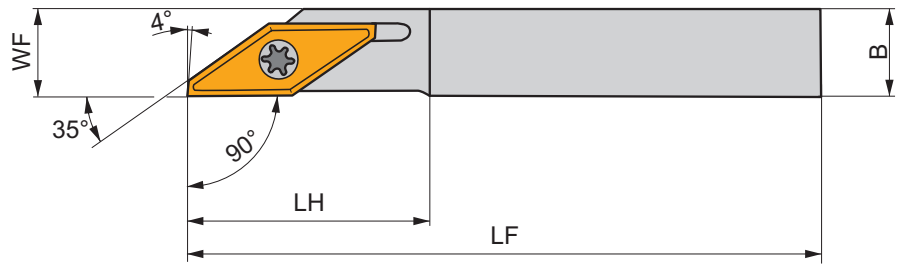
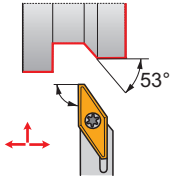

Product	H (mm)	B (mm)	HF (mm)	WF (mm)	LF (mm)	LH (mm)	LAMS (°)	GAMO (°)	kg		
R SVACR 1010 L 13-DC	10	10	10	10	140	25.0	0	0	0.12	G1222	SV20
SVACR 1212 L 13-DC	12	12	12	12	140	25.0	0	0	0.17	G1222	SV20
SVACR 1616 M 13-DC	16	16	16	16	150	25.0	0	0	0.29	G1222	SV20
SVACR 2020 M 13-DC	20	20	20	20	150	25.0	0	0	0.46	G1222	SV20
L SVACL 1212 L 13-DC	12	12	12	12	140	25.0	0	0	0.19	G1222	SV20
SVACL 1616 M 13-DC	16	16	16	16	150	25.0	0	0	0.29	G1222	SV20
SVACL 2020 M 13-DC	20	20	20	20	150	25.0	0	0	0.43	G1222	SV20
SVACL 2525 M 13-DC	25	25	25	25	150	25.0	0	0	0.67	G1222	SV20

G1222	VCGX 1303..

SV20	5513 020-24	1.5	M3	8.5	PT-8002

SVJC(RL)-DC EXT

P
M
K
N
S
H

PRAMET

S



Ext. Screw Lock Swiss Style Tool Holder, 93° Cutting Angle for VCGX Insert

External Right/Left hand tool holder for screw type positive VCGX 13 Swiss style inserts. Suited for external face and longitudinal turning with shoulder, taper, copy turning up to 50° and chamfer turning. Body treated for longer tool life.

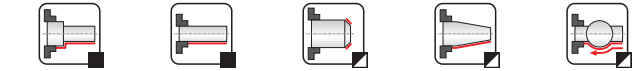
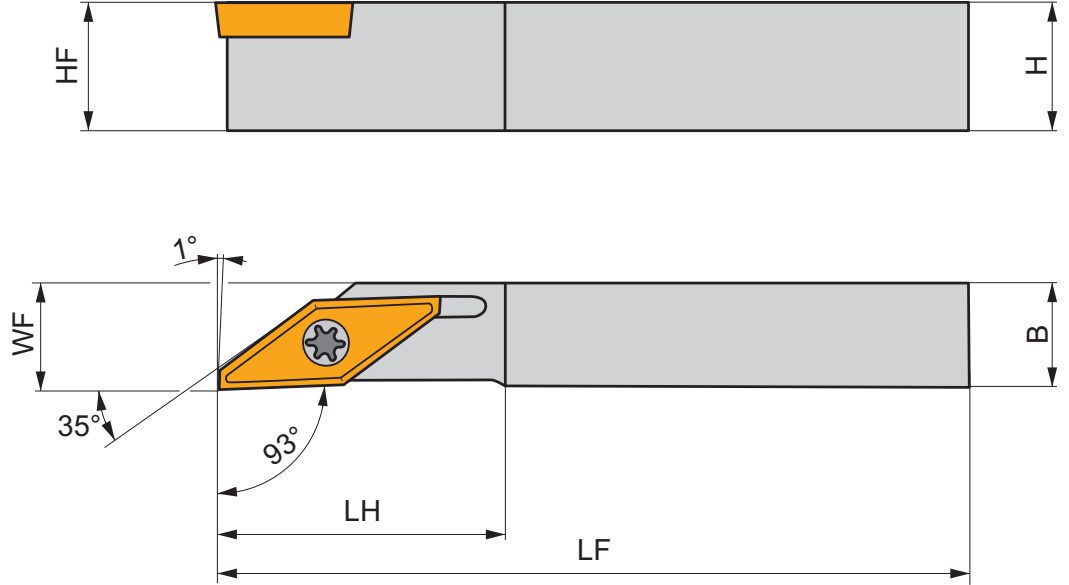
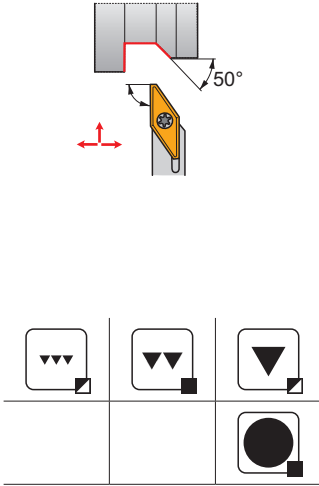

Product	H (mm)	B (mm)	HF (mm)	WF (mm)	LF (mm)	LH (mm)	LAMS (°)	GAMO (°)	kg		
R SVJCR 1212 L 13-DC	12	12	12	–	140	25.0	0	0	0.17	GI222	SV20
SVJCR 1616 M 13-DC	16	16	16	–	150	25.0	0	0	0.29	GI222	SV20
SVJCR 2020 M 13-DC	20	20	20	–	150	25.0	0	0	0.45	GI222	SV20
SVJCR 2525 M 13-DC	25	25	25	–	150	25.0	0	0	0.68	GI222	SV20
L SVJCL 1212 L 13-DC	12	12	12	–	140	25.0	0	0	0.17	GI222	SV20
SVJCL 1616 M 13-DC	16	16	16	–	150	25.0	0	0	0.30	GI222	SV20
SVJCL 2020 M 13-DC	20	20	20	–	150	25.0	0	0	0.47	GI222	SV20
SVJCL 2525 M 13-DC	25	25	25	–	150	25.0	0	0	0.69	GI222	SV20

	GI222		VCGX 1303..
--	-------	--	-------------

	SV20		5513 020-24		1.5		M3		8.5		PT-8002
--	------	--	-------------	--	-----	--	----	--	-----	--	---------

SVLC(RL) INT

P
M
K
N
S
H

PRAMET

S



Internal Screw Lock Boring Bar with 50° Cutting Angle for VC.. Inserts

Internal Right/Left hand boring bar, through coolant, with 50° cutting angle for screw type VC.. inserts. Suited for a wide range of internal pulling turning operations and copying under 48°. Body treated for longer tool life.

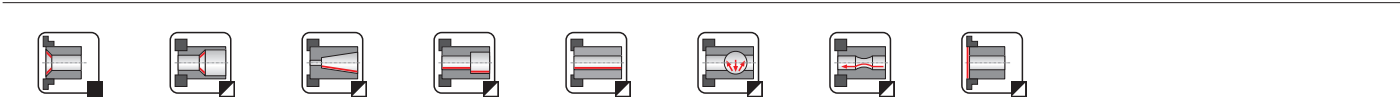
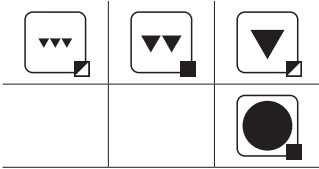
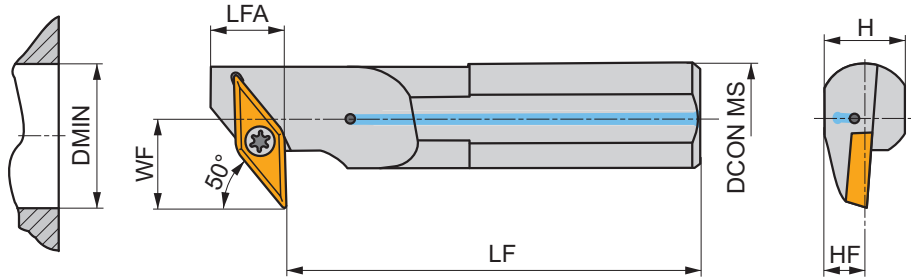
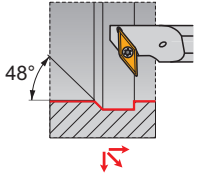

Product	DCON MS	DMIN	WF	H	LF	HF	LFA	LAMS	GAMO				
	(mm)	(mm)	(mm)	(mm)	(mm)	(mm)	(mm)	(°)	(°)				
R	A20S-SVLCR 13-X	20	27	15	18	250	9	15	-4	-2	✓	0.57	G1211 SV21
	A25T-SVLCR 13-X	25	35	20	24	300	12	18	-2	-2	✓	1.01	G1211 SV22
	A32T-SVLCR 13-X	32	43	25	30	300	15	18	-1	-2	✓	1.75	G1211 SV22
L	A20S-SVLCCL 13-X	20	27	15	18	250	9	15	-4	-2	✓	0.57	G1211 SV21
	A25T-SVLCCL 13-X	25	35	20	24	300	12	18	-2	-2	✓	0.05	G1211 SV22
	A32T-SVLCCL 13-X	32	43	25	30	300	15	18	-1	-2	✓	1.75	G1211 SV22

G1211	VC.. 1303..

SV21	5513 020-24	1.5	M3	8.5	-	-	PT-8002	-
SV22	DVF 0573	1.5	M3	10.3	DAP 0331	DVT 0332	PT-8002	174.1-870

SVXC(RL) INT



PRAMET



Internal Screw Lock Boring Bar with 113° Cutting Angle for VC.. Inserts

Internal Right/Left hand boring bar, through coolant, with 113° cutting angle for screw type VC.. inserts. Suited for a wide range of internal turning operations and copying under 32°. Body treated for longer tool life.

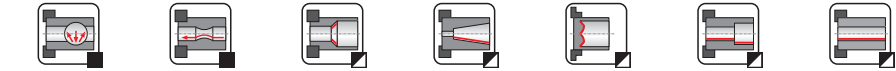
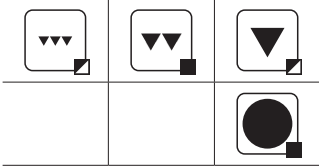
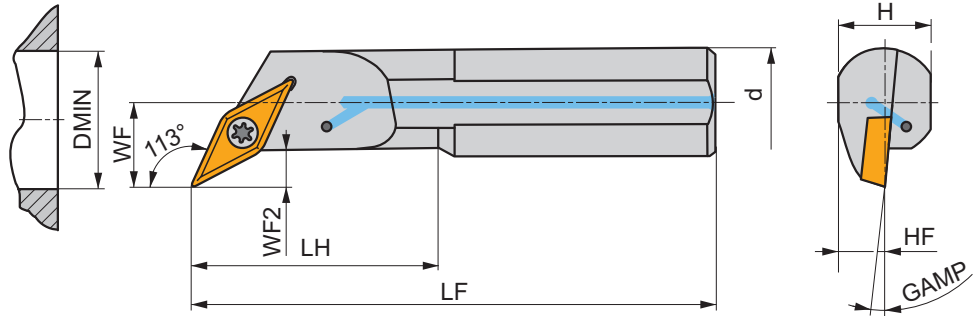
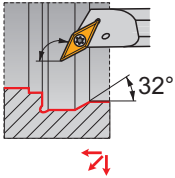

Product	DCON MS	DMIN	WF	H	LF	HF	LH	WF2	GAMP				
	(mm)	(mm)	(mm)	(mm)	(mm)	(mm)	(mm)	(mm)	(°)				
R	A10H-SVXCR 07	10	12.5	7	9	100	4.5	22.0	3	-10	✓	0.06	GI234 SV23
	A12K-SVXCR 07	12	15.5	9	11	125	5.5	28.0	3	-8	✓	0.11	GI234 SV23
	A16M-SVXCR 07	16	17.5	11	15	150	7.5	36.0	3	-6	✓	0.19	GI234 SV23
L	A10H-SVXCL 07	10	12.5	7	9	100	4.5	22.0	3	-10	✓	0.06	GI234 SV23
	A12K-SVXCL 07	12	15.5	9	11	125	5.5	28.0	3	-8	✓	0.11	GI234 SV23
	A16M-SVXCL 07	16	17.5	11	15	150	7.5	36.0	3	-6	✓	0.20	GI234 SV23

	GI234		VC.. 0702..
--	-------	--	-------------

	SV23		DVF 3584		0.6 Nm		M2		5.5		DMD 1650
--	------	--	----------	--	--------	--	----	--	-----	--	----------

SVXC(RL)-E INT

P
M
K
N
S
H

PRAMET

S



Internal Carbide Screw Lock Boring Bar, 113° Cutting Angle for VC.. Inserts

Internal Right/Left hand carbide boring bar, through coolant, with 113° cutting angle for screw type VC.. inserts. Suited for a wide range of internal turning operations and copying under 32°. For tool overhang >3xD.

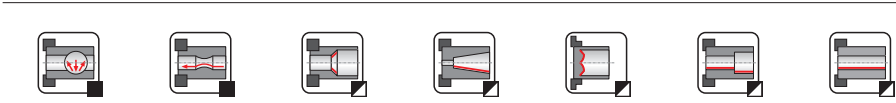
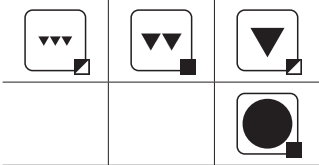
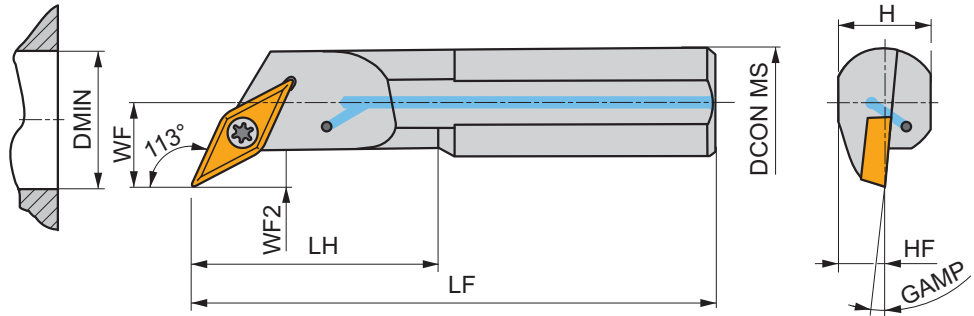
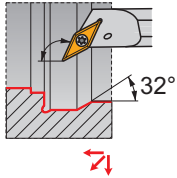

Product	DCON MS	DMIN	WF	H	HF	LF	LH	WF2	GAMP					
	(mm)	(mm)	(mm)	(mm)	(mm)	(mm)	(mm)	(mm)	(°)					
R	E10H-SVXCR 07	10	12.5	7	9	4.5	100	22.0	3	-10	✓	0.10	GI234	SV23
	E12K-SVXCR 07	12	15.5	9	11	5.5	125	28.0	3	-8	✓	0.18	GI234	SV23
	E16M-SVXCR 07	16	17.5	11	15	7.5	150	36.0	3	-6	✓	0.33	GI234	SV23
L	E10H-SVXCL 07	10	12.5	7	9	4.5	100	22.0	3	-10	✓	0.10	GI234	SV23
	E16M-SVXCL 07	16	17.5	11	15	7.5	150	36.0	3	-6	✓	0.33	GI234	SV23

GI234
 VC.. 0702..

SV23
 DVF 3584
 0.6
 M 2
 5.5
 DMD 1650

SWLC(RL) EXT

P
M
K
N
S
H

PRAMET

S

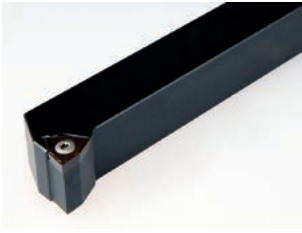

External Screw Lock Tool Holder with 95° Cutting Angle for WC.. Inserts

External Right/Left hand tool holder for screw type positive screw type WC.. inserts. Suited for face and longitudinal turning with shoulder, taper and chamfer turning. Body treated for longer tool life.

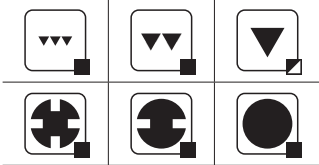
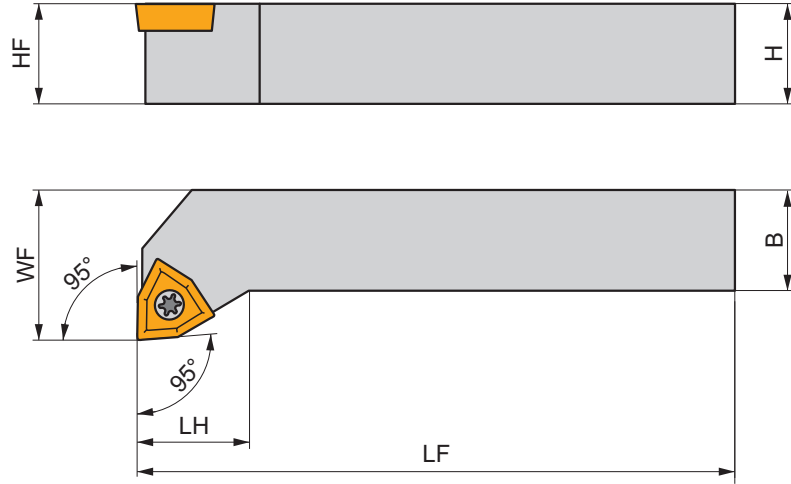
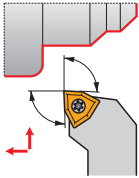

Product	H (mm)	B (mm)	HF (mm)	WF (mm)	LF (mm)	LH (mm)	LAMS (°)	GAMO (°)	kg	GI049	GI055	S04	S09
R SWLCR 1616 H 06	16	16	16	20	100	15.0	0	0	0.23	GI055		S04	
SWLCR 2020 K 06	20	20	20	25	125	15.0	0	0	0.42	GI055		S04	
SWLCR 2525 M 08	25	25	25	32	150	20.0	0	0	0.76	GI049		S09	
L SWLCL 1616 H 06	16	16	16	20	100	15.0	0	0	0.23	GI055		S04	
SWLCL 2020 K 06	20	20	20	25	125	15.0	0	0	0.40	GI055		S04	
SWLCL 2525 M 08	25	25	25	32	150	20.0	0	0	0.75	GI049		S09	

GI049	GI055	WC.. 0804..	WC.. 06T3..

S04	US 3510-T15P	3.0 Nm	M 3.5	10.6	FLAGT15P
S09	US 4512-T15P	5.0	M 4.5	12.2	FLAGT15P

SWLC(RL) INT

P M K N S H

PRAMET

S



Internal Screw Lock Boring Bar with 95° Cutting Angle for WC.. Inserts

Internal Right/Left hand boring bar, through coolant available, 95° cutting angle for screw type WC.. inserts. For internal taper and longitudinal turning with shoulder and chamfer turning. Body treated for longer tool life.

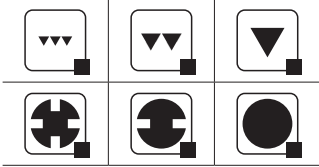
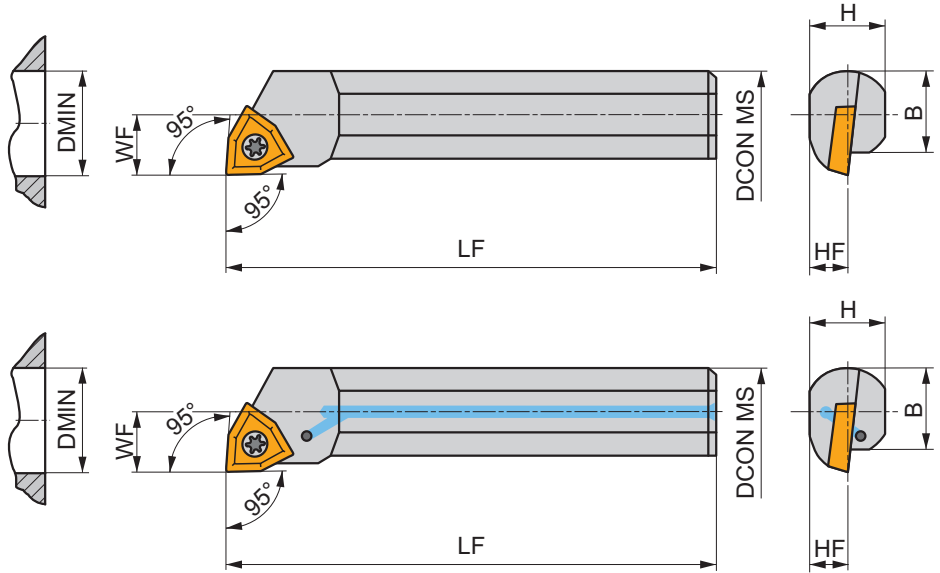
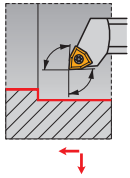

Product	DCON MS	DMIN	WF	H	B	LF	LAMS	GAMO					
	(mm)	(mm)	(mm)	(mm)	(mm)	(mm)	(°)	(°)					
R	A20Q-SWLCR 06	20	25	13	18	18.5	180	-7	0	✓	0.37	GI055	S04
	S20S-SWLCR 06	20	25	13	18	18.5	250	-7	0	-	0.60	GI055	S04
	S25T-SWLCR 06	25	32	17	23	23	300	-7	0	-	1.12	GI055	S04
	A25R-SWLCR 08	25	32	17	23	23	200	-7	0	✓	0.70	GI049	S04
	A32S-SWLCR 08	32	40	22	30	30	250	-5	0	✓	1.32	GI049	S09
S32U-SWLCR 08	32	40	22	30	30	350	-5	0	-	2.05	GI049	S09	
L	A20Q-SWLCL 06	20	25	13	18	18.5	180	-7	0	✓	0.00	GI055	S04
	S20S-SWLCL 06	20	25	13	18	18.5	250	-7	0	-	0.60	GI055	S04
	A25R-SWLCL 06	25	32	17	23	23	200	-7	0	✓	0.66	GI055	S04

GI049	WC.. 0804..
GI055	WC.. 06T3..

S04	US 3510-T15P	3.0	M 3.5	10.6	FLAGT15P
S09	US 4512-T15P	5.0	M 4.5	12.2	FLAGT15P

SWUC(RL) INT

P
M
K
N
S
H

PRAMET

S



Internal Screw Lock Boring Bar with 93° Cutting Angle for WC.. Inserts

Internal Right/Left hand boring bar, through coolant available, 93° cutting angle for screw type WC.. inserts. Suited for internal taper and longitudinal turning with shoulder and chamfer turning. Body treated for longer tool life.

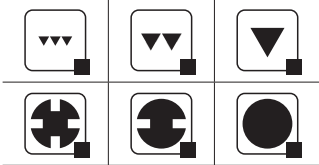
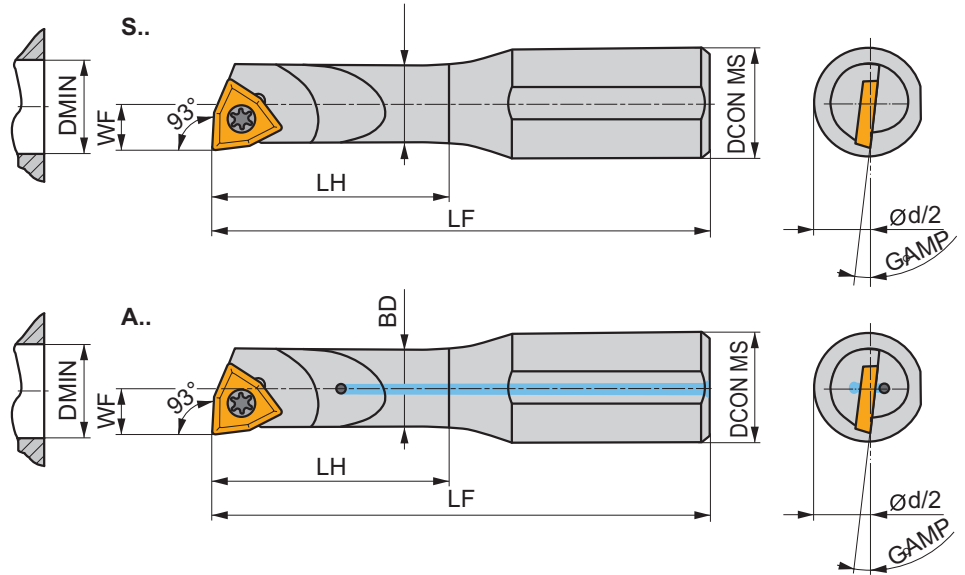
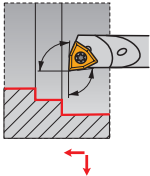

Product	DCON MS	DMIN	BD	WF	LF	LH	GAMP					
	(mm)	(mm)	(mm)	(mm)	(mm)	(mm)	(°)					
R	A0508H-SWUCR 02	8	5.8	5	2.9	100	18.0	-17	✓	0.04	GI221	SW21
	S0508H-SWUCR 02	8	5.8	5	2.9	100	18.0	-17	-	0.03	GI221	SW21
	A0608H-SWUCR 02	8	7.8	6	3.9	100	24.0	-12	✓	0.04	GI221	SW21
	S0608H-SWUCR 02	8	7.8	6	3.9	100	24.0	-12	-	0.04	GI221	SW21
L	A0508H-SWUCL 02	8	5.8	5	2.9	100	18.0	-17	✓	0.04	GI221	SW21
	S0508H-SWUCL 02	8	5.8	5	2.9	100	18.0	-17	-	0.04	GI221	SW21
	A0608H-SWUCL 02	8	7.8	6	3.9	100	24.0	-12	✓	0.04	GI221	SW21
	S0608H-SWUCL 02	8	7.8	6	3.9	100	24.0	-12	-	0.04	GI221	SW21

	GI221		WC.. 0201..
--	-------	--	-------------

	SW21		T20.037		Nm	0.6		M2		3.7		DMD 1650
--	------	--	---------	--	----	-----	--	----	--	-----	--	----------

SWUC(RL)-E INT

P
M
K
N
S
H

PRAMET

S



Internal carbide Screw Lock Boring Bar with 93° Cutting Angle for WC.. Inserts

Internal Right/Left hand carbide boring bar, through coolant, with 93° cutting angle for screw type WC.. inserts. Suited for internal taper and longitudinal turning with shoulder and chamfer turning. For tool overhang >3xD.

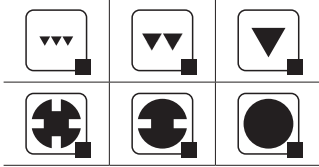
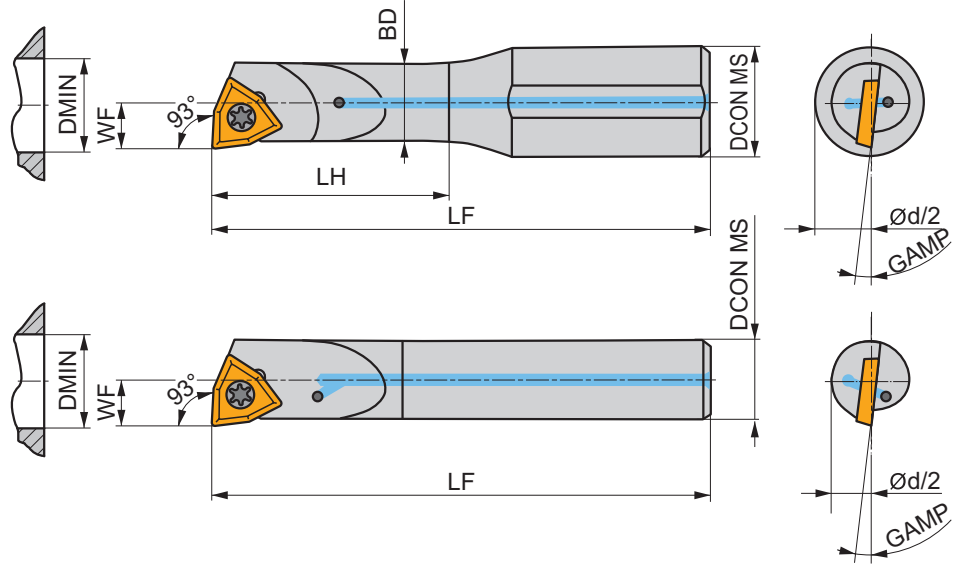
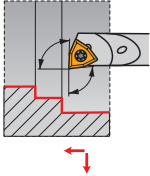

Product	DCON MS	DMIN	BD	WF	LF	LH	GAMP				
	(mm)	(mm)	(mm)	(mm)	(mm)	(mm)	(°)				
R E0508H-SWUCR 02	8	5.8	5	2.9	100	24.0	-17	✓	0.06	GI221	SW21
E05F-SWUCR 02	5	5.8	-	2.9	85	-	-17	✓	0.03	GI221	SW21
E0608H-SWUCR 02	8	7.8	6	3.9	100	32.0	-12	✓	0.06	GI221	SW21
E06G-SWUCR 02	6	7.8	-	3.9	95	-	-12	✓	0.04	GI221	SW21
L E0508H-SWUCL 02	8	5.8	5	2.9	100	24.0	-17	✓	0.06	GI221	SW21
E05F-SWUCL 02	5	5.8	-	2.9	85	-	-17	✓	0.03	GI221	SW21
E0608H-SWUCL 02	8	7.8	6	3.9	100	32.0	-12	✓	0.06	GI221	SW21
E06G-SWUCL 02	6	7.8	-	3.9	95	-	-12	✓	0.04	GI221	SW21



GI221



WC.. 0201..



SW21



T20.037



0.6



M 2



3.7



DMD 1650

S CLAMPING DESIGNATION

TOOLS – NAVIGATOR

ISO TURNING – EXTERNAL

LONG AND UNSTABLE COMPONENTS (positive inserts)

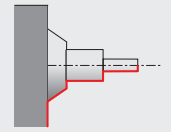

<p>SCAC(RL) EXT 90°</p> <p>CC..</p> <p>77</p>	<p>SCBC(RL) EXT 75°</p> <p>CC..</p> <p>78</p>	<p>SCDCR EXT 45°</p> <p>CC..</p> <p>79</p>	<p>SCFC(RL) EXT 90°</p> <p>CC..</p> <p>80</p>
<p>SCLC(RL) EXT 95°</p> <p>CC..</p> <p>81</p>	<p>SDFC(RL) EXT 91°</p> <p>DC..</p> <p>90</p>	<p>SDJC(RL) EXT 93°</p> <p>DC..</p> <p>91</p>	<p>SDNCN EXT 62°30'</p> <p>DC..</p> <p>93</p>
<p>SDUCL EXT 93°</p> <p>DC..</p> <p>94</p>	<p>SDXC(RL) EXT 62°30'</p> <p>DC..</p> <p>95</p>	<p>SEGC(RL) EXT 90°</p> <p>EC..</p> <p>103</p>	<p>SRDC(RL) EXT</p> <p>RC..</p> <p>112</p>
<p>SRDCN EXT</p> <p>RC..</p> <p>113</p>	<p>SRSC (RL) EXT</p> <p>RC..</p> <p>114</p>	<p>SSBC(RL) EXT 75°</p> <p>SC..</p> <p>119</p>	<p>SSDCN EXT 45°</p> <p>SC..</p> <p>120</p>
<p>SSKC(RL) EXT 75°</p> <p>SC..</p> <p>121</p>	<p>STAC(RL) EXT 90°</p> <p>TC..</p> <p>125</p>	<p>STFC(RL) EXT 90°</p> <p>TC..</p> <p>126</p>	<p>STFC(RL)-A EXT 90°</p> <p>TC..</p> <p>127</p>

S CLAMPING DESIGNATION TOOLS – NAVIGATOR

ISO TURNING – EXTERNAL
LONG AND UNSTABLE COMPONENTS (positive inserts)

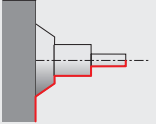

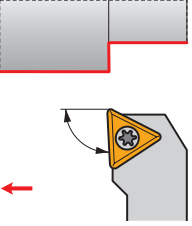
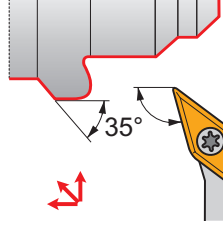
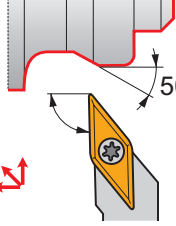
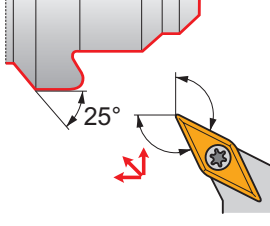
<p>STJC(RL) EXT 93°</p> <p>TC..</p>  <p>128</p>	<p>SVHB(C)(RL) EXT 107°30'</p> <p>VB, VC..</p>  <p>132</p>	<p>SVJB(C)(RL) EXT 93°</p> <p>VB, VC..</p>  <p>133</p>	<p>SVPB(C)(RL) EXT 117°30'</p> <p>VB, VC..</p>  <p>135</p>
---	--	---	--

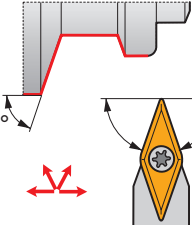
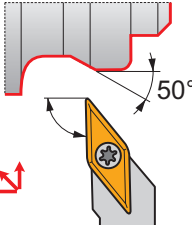
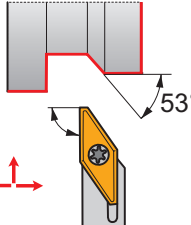
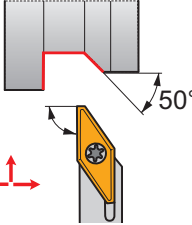
<p>SVVB(C)N EXT 72°30'</p> <p>VB, VC..</p>  <p>136</p>	<p>SVXB(C)(RL) EXT 98°</p> <p>VB, VC..</p>  <p>137</p>	<p>SVAC(RL)-DC EXT 90°</p> <p>VC..</p>  <p>145</p>	<p>SVJC(RL)-DC EXT 93°</p> <p>VC..</p>  <p>146</p>
---	---	--	---

SWLC(RL) EXT 95°

WC..

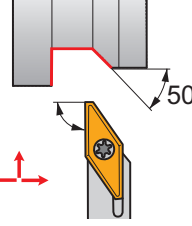

150

P CLAMPING DESIGNATION TOOLS – NAVIGATOR

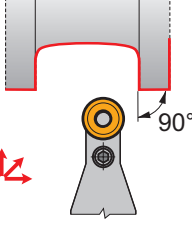
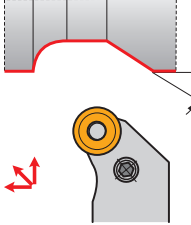
<p>PRDCN EXT</p> <p>RC..</p>  <p>110</p>	<p>PRSC(RL) EXT</p> <p>RC..</p>  <p>111</p>
--	--

KHP / DKH CLAMPING DESIGNATION TOOLS – NAVIGATOR

ISO TURNING – HEAVY ROUGHING – EXTERNAL
HEAD (KH)

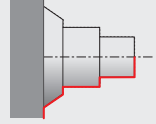

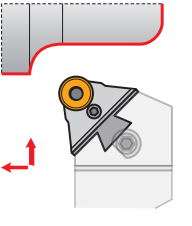
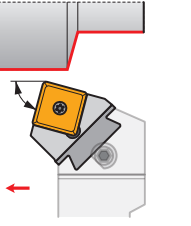
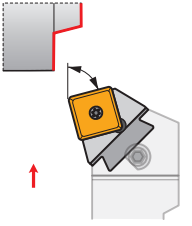
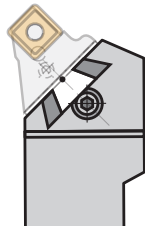
<p>KHP-RSCR/L</p> <p>RC..</p>  <p>117</p>	<p>KHS-SBCR 75°</p> <p>SC..</p>  <p>123</p>	<p>KHS-SBCL 75°</p> <p>SC..</p>  <p>123</p>	<p>DKH(RL)</p>  <p>118, 124</p>
---	---	--	---

S CLAMPING DESIGNATION

TOOLS – NAVIGATOR

ISO TURNING – INTERNAL
LONG AND UNSTABLE COMPONENTS (positive inserts)

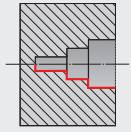

<p>SCFC(RL) INT 90°</p> <p>CC..</p> <p>84</p>	<p>SCKC(RL) INT 75°</p> <p>CC..</p> <p>85</p>	<p>SCLC(RL) INT 45°</p> <p>CC..</p> <p>86</p>	<p>SCXC(RL) INT 90°</p> <p>CC..</p> <p>88</p>
<p>SDQC(RL) INT 95°</p> <p>DC..</p> <p>98</p>	<p>SDUC(RL) INT 93°</p> <p>DC..</p> <p>99</p>	<p>SDUC(RL)-E INT 62°30'</p> <p>DC..</p> <p>100</p>	<p>SDZC(RL) INT 90°</p> <p>DC..</p> <p>101</p>
<p>SEUC(RL) INT 93°</p> <p>EC..</p> <p>104</p>	<p>SELP(RL) INT 95°</p> <p>EP..</p> <p>105</p>	<p>SELP(RL)-E INT 95°</p> <p>EP..</p> <p>106</p>	<p>SEUP(RL) INT 93°</p> <p>EP..</p> <p>107</p>
<p>SEXP(RL) INT 52°30'</p> <p>EP..</p> <p>108</p>	<p>SEXP(RL)-E INT 52°30'</p> <p>EP..</p> <p>109</p>	<p>SSSC(RL) INT 45°</p> <p>SC..</p> <p>122</p>	<p>STFC(RL) INT 90°</p> <p>TC..</p> <p>129</p>
<p>STFC(RL)-E INT 90°</p> <p>TC..</p> <p>131</p>	<p>SVJB(RL) INT 93°</p> <p>VB, VC..</p> <p>141</p>	<p>SVQB(C)(RL) INT 107°30'</p> <p>VB, VC..</p> <p>142</p>	<p>SVUB(C)(RL) INT 93°</p> <p>VB, VC..</p> <p>143</p>

S CLAMPING DESIGNATION

TOOLS – NAVIGATOR

ISO TURNING – INTERNAL

LONG AND UNSTABLE COMPONENTS (positive inserts)

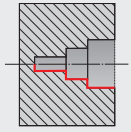

SVLC(RL) INT 95°
 VC..

48°

147

SVXC(RL) INT 113°
 VC..

32°

148

SVXC(RL)-E INT 113°
 VC..

32°

149

SWLC(RL) INT 95°
 WC..

151

SWUC(RL) INT 93°
 WC..

152

SWUC(RL)-E INT 93°
 WC..

153

S CLAMPING DESIGNATION

TOOLS – NAVIGATOR

ISO TURNING – EXTERNAL PSC LONG AND UNSTABLE COMPONENTS (positive inserts)

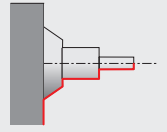

C.-SCLC(RL) EXT 95° CC.. 83	C.-SDJC(RL) EXT 93° DC.. 96	C.-SDNCN EXT 62°30' DC.. 97	C.-SRDCN EXT RC.. 116
C.-SVHB(RL) EXT 107°30' VB, VC.. 138	C.-SVJB(RL) EXT 93° VB, VC.. 139	C.-SVVBN EXT 72°30' VB, VC.. 140	

ISO TURNING – INTERNAL PSC LONG AND UNSTABLE COMPONENTS (positive inserts)

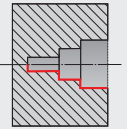

C.-SCLC(RL) INT 95° CC.. 89	C.-SDUC(RL) INT 93° DC.. 102	C.-SVQB(C)(RL) INT 108° VB, VC.. 144
--	---	---



NEGATIVE INSERTS

ISO INSERTS NEGATIVE – CHIPBREAKER NAVIGATOR

P

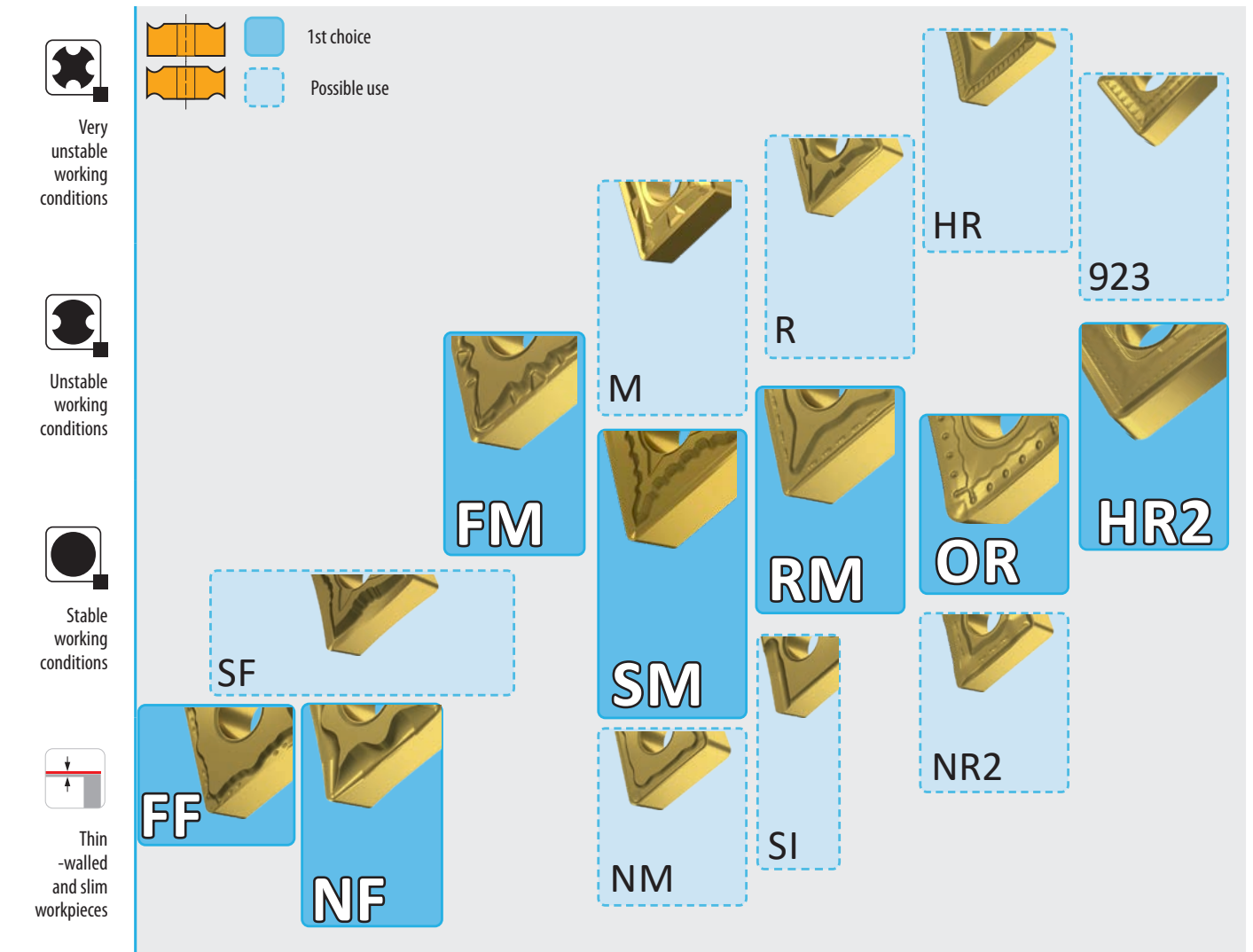

	0.05 – 0.2 mm/rev	0.05 – 0.2 mm/rev	0.2 – 0.4 mm/rev	0.4 – 1.0 mm/rev	> 1.0 mm/rev
	0.05 – 2 mm	0.05 – 2 mm	2 – 4 mm	4 – 10 mm	> 10 mm

FF		Highly positive geometry designed for fine finish machining, stainless steel and steel, potentially cast irons, continuous cuts	SM		Positive geometry designed for medium machining, stainless steels, super alloys, steels and cast irons, potentially non ferrous and hard materials and for machining thin walls, continuous and interrupted cuts
NF		Highly positive design for fine finish and medium machining, stainless steels, steel, potentially cast irons, non ferrous materials and super alloys, continuous cuts	RM		Designed for semi-rough and rough machining, steels, stainless steels and cast irons, potentially super alloys, continuous and interrupted cuts
FM		Positive geometry designed for finish to semi-rough machining, steel and cast irons, potentially and super alloys, continuous and moderately interrupted cuts	OR		Designed for finish to heavy rough machining, steels and cast irons, potentially stainless steel and super alloys, continuous and interrupted cuts

ISO INSERTS NEGATIVE – CHIPBREAKER NAVIGATOR

M

Very unstable working conditions

Unstable working conditions

Stable working conditions

Thin-walled and slim workpieces

1st choice
 Possible use

FM

SM

NRM

HR

923

OR

NR2

HR2

SF

FF

NF

NM

SI



	0.05 – 0.2 mm/rev	0.05 – 0.2 mm/rev	0.2 – 0.4 mm/rev	0.4 – 1.0 mm/rev	> 1.0 mm/rev
	0.05 – 2 mm	0.05 – 2 mm	2 – 4 mm	4 – 10 mm	> 10 mm

FF	<p>0.06 0.09 7° 22°</p>	Highly positive geometry designed for fine finish machining, stainless steel and steel, potentially cast irons, continuous cuts	SM	<p>13° 5° 0.25</p>	Positive geometry designed for medium machining, stainless steels, super alloys, steels and cast irons, potentially non ferrous and hard materials and for machining thin walls, continuous and interrupted cuts
SF	<p>1.94 14.5°</p>	Versatile positive geometry designed for fine finish machining, steels, stainless steels, cast irons and super alloys and hard materials, potentially non ferrous materials and for machining thin walls, with continuous cuts	NMR	<p>22° 10° 0.31</p>	Positive design for medium to rough machining, stainless steels as well as soft steels and super alloys, continuous cuts
NF	<p>25° 12° 0.15</p>	Highly positive design for fine finish and medium machining, stainless steels, steel, potentially cast irons, non ferrous materials and super alloys, continuous cuts	NR2	<p>0.41 10.13 121° 15°</p>	Designed for finish to rough machining, stainless steels and steels, potentially cast irons and super alloys, continuous and interrupted cuts

ISO INSERTS NEGATIVE – CHIPBREAKER NAVIGATOR

K

Very unstable working conditions

Unstable working conditions

Stable working conditions

Thin-walled and slim workpieces

1st choice
 Possible use

	.NMA	M		HR	
			R	OR	923
				NR2	HR2
	SF	FM	SM	KR	



	0.05 – 0.2 mm/rev	0.05 – 0.2 mm/rev	0.2 – 0.4 mm/rev	0.4 – 1.0 mm/rev	> 1.0 mm/rev
	0.05 – 2 mm	0.05 – 2 mm	2 – 4 mm	4 – 10 mm	> 10 mm

.NMA		Designed for fine finish to semi rough machining, cast irons, potentially hard materials, continuous and slightly interrupted cuts
M		Designed for finish and semi-rough machining, cast irons, potentially steels and hard materials, continuous and interrupted cuts
KR		Designed for semi-rough and rough machining, cast irons, potentially steel and hard materials, continuous and interrupted cuts
OR		Designed for finish to heavy rough machining, steels and cast irons, potentially stainless steel and super alloys, continuous and interrupted cuts
HR2		Designed for rough to heavy rough machining with high feeds, steels and cast irons, potentially stainless steels, continuous and interrupted cuts

ISO INSERTS NEGATIVE – CHIPBREAKER NAVIGATOR

N

Very unstable working conditions

Unstable working conditions

Stable working conditions

Thin-walled and slim workpieces

1st choice

Possible use

SF SM

NF NM SI

	0.05 – 0.2 mm/rev	0.05 – 0.2 mm/rev	0.2 – 0.4 mm/rev	0.4 – 1.0 mm/rev	> 1.0 mm/rev
	0.05 – 2 mm	0.05 – 2 mm	2 – 4 mm	4 – 10 mm	> 10 mm

SF		<p>Versatile positive geometry designed for fine finish machining, steels, stainless steels, cast irons and super alloys and hard materials, potentially non ferrous materials and for machining thin walls, with continuous cuts</p>
NF		<p>Highly positive design for fine finish and medium machining, stainless steels, steel, potentially cast irons, non ferrous materials and super alloys, continuous cuts</p>
SM		<p>Positive geometry designed for medium machining, stainless steels, super alloys, steels and cast irons, potentially non ferrous and hard materials and for machining thin walls, continuous and interrupted cuts</p>
NM		<p>Highly positive design for fine finish, medium and rough machining, stainless steels, steels, potentially non ferrous materials and super alloys, continuous cuts</p>
SI		<p>Positive geometry for fine finish to semi-rough machining, steels, stainless steels and cast irons and potentially non ferrous materials, continuous cuts</p>

ISO INSERTS NEGATIVE – CHIPBREAKER NAVIGATOR

S

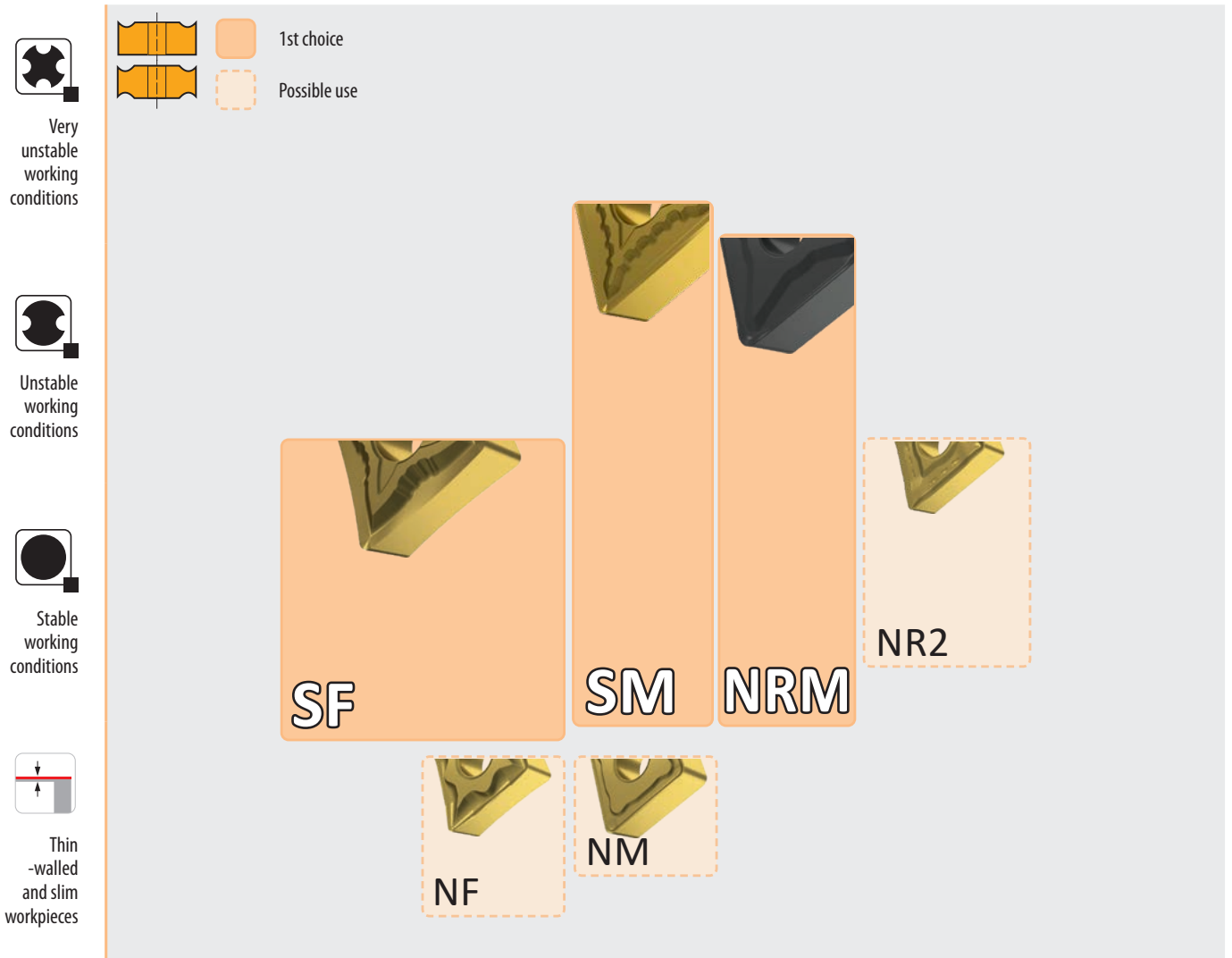

	FF	F	M	R	HR
f	0.05 – 0.2 mm/rev	0.05 – 0.2 mm/rev	0.2 – 0.4 mm/rev	0.4 – 1.0 mm/rev	> 1.0 mm/rev
a_p	0.05 – 2 mm	0.05 – 2 mm	2 – 4 mm	4 – 10 mm	> 10 mm

SF		Versatile positive geometry designed for fine finish machining, steels, stainless steels, cast irons and super alloys and hard materials, potentially non ferrous materials and for machining thin walls, with continuous cuts		
SM		Positive geometry designed for medium machining, stainless steels, super alloys, steels and cast irons, potentially non ferrous and hard materials and for machining thin walls, continuous and interrupted cuts		
NRM		Positive design for semi-rough and rough machining, stainless steel, soft steels and super alloys, continuous cuts		

ISO INSERTS NEGATIVE – CHIPBREAKER NAVIGATOR

H



Very unstable working conditions



Unstable working conditions



Stable working conditions







Thin-walled and slim workpieces

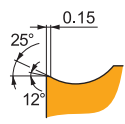

	0.05 – 0.2 mm/rev	0.05 – 0.2 mm/rev	0.2 – 0.4 mm/rev	0.4 – 1.0 mm/rev	> 1.0 mm/rev
	0.05 – 2 mm	0.05 – 2 mm	2 – 4 mm	4 – 10 mm	> 10 mm

SF		Versatile positive geometry designed for fine finish machining, steels, stainless steels, cast irons and super alloys and hard materials, potentially non ferrous materials and for machining thin walls, with continuous cuts
SM		Positive geometry designed for medium machining, stainless steels, super alloys, steels and cast irons, potentially non ferrous and hard materials and for machining thin walls, continuous and interrupted cuts
.NMA		Designed for fine finish to semi rough machining, cast irons, potentially hard materials, continuous and slightly interrupted cuts
R		Designed for semi-rough and rough machining, cast irons, potentially steel and hard materials, continuous and interrupted cuts

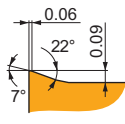
FINE-FINISHING – NAVIGATOR

<p>NF</p>			<p>NF chip breaker is sharp and the first choice for fine-finishing of Steels, Stainless steels. It features highly positive rake angle and highly positive, narrow T-land. It's also conditionally suitable for Cast irons and Non-ferrous alloys and Super-alloy</p>
<p>FF</p>			<p>FF chip breaker is sharp and designed for fine-finishing of Steels, Stainless steels. It features positive rake angle and positive, thin T-land. It's also conditionally suitable for Cast irons.</p>

NF

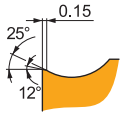

NF chip breaker is sharp and the first choice for fine-finishing of Steels, Stainless steels. It features highly positive rake angle and highly positive, narrow T-land. It's also conditionally suitable for Cast irons and Non-ferrous alloys and Super-alloy



CNMG

	IC (mm)	D1 (mm)	L (mm)	S (mm)
0903	9.525	3.81	9.70	3.18
1204	12.700	5.16	12.90	4.76

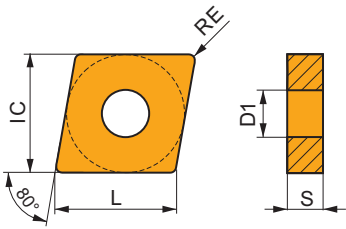

DNMG

	IC (mm)	D1 (mm)	L (mm)	S (mm)
1104	9.525	3.81	11.60	4.76
1504	12.700	5.16	15.50	4.76
1506	12.700	5.16	15.50	6.35

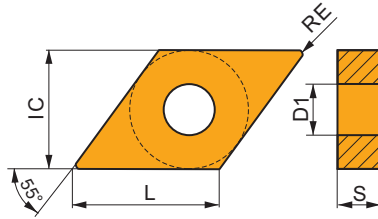

SNMG

	IC (mm)	D1 (mm)	L (mm)	S (mm)
1204	12.700	5.16	12.70	4.76

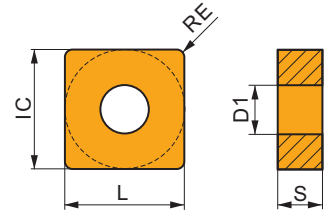

TNMG

	IC (mm)	D1 (mm)	L (mm)	S (mm)
1604	9.525	3.81	16.50	4.76

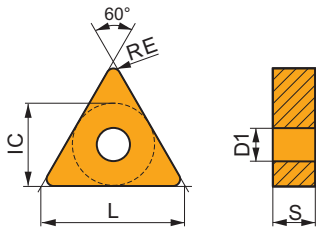

VNMG

	IC (mm)	D1 (mm)	L (mm)	S (mm)
1604	9.525	3.81	16.60	4.76

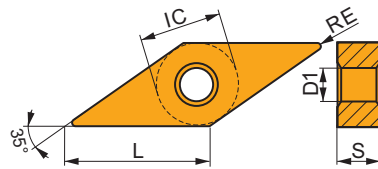

WNMG

	IC (mm)	D1 (mm)	L (mm)	S (mm)
0604	9.525	3.81	6.50	4.76
0804	12.700	5.16	8.70	4.76

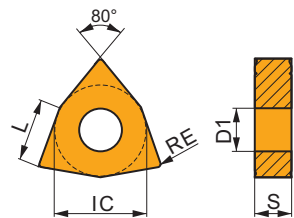

Suitability and starting values for cutting speed (vc), feed (f) and depth of cut (ap). Refer to our Machining Calculator app for further calculations.

Product	RE (mm)	P			M			K			N			S			H		
		vc (m/min)	f (mm/rev)	ap (mm)	vc (m/min)	f (mm/rev)	ap (mm)	vc (m/min)	f (mm/rev)	ap (mm)	vc (m/min)	f (mm/rev)	ap (mm)	vc (m/min)	f (mm/rev)	ap (mm)	vc (m/min)	f (mm/rev)	ap (mm)

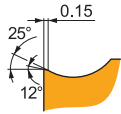
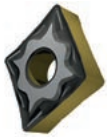

NF chip breaker is sharp and the first choice for fine-finishing of Steels, Stainless steels. It features highly positive rake angle and highly positive, narrow T-land. It's also conditionally suitable for Cast irons and Non-ferrous alloys and Super-alloy

CNMG 090304E-NF:T6310	● 0.4	■ 190	■ 0.17	■ 0.8	■ 135	■ 0.15	■ 0.8	■ 150	■ 0.17	■ 0.8	■ 570	■ 0.20	■ 0.8	■ 55	■ 0.12	■ 0.6	-	-	-
CNMG 090304E-NF:T7335	● 0.4	■ 210	■ 0.18	■ 0.8	■ 160	■ 0.16	■ 0.8	-	-	-	-	-	-	■ 65	■ 0.16	■ 0.6	-	-	-
CNMG 090304E-NF:T8430	● 0.4	■ 225	■ 0.17	■ 0.8	■ 120	■ 0.15	■ 0.8	■ 185	■ 0.17	■ 0.8	■ 615	■ 0.20	■ 0.8	■ 45	■ 0.12	■ 0.6	-	-	-
CNMG 090304E-NF:T9325	● 0.4	■ 265	■ 0.18	■ 0.8	■ 155	■ 0.16	■ 0.8	■ 250	■ 0.18	■ 0.8	-	-	-	■ 55	■ 0.16	■ 0.6	-	-	-
CNMG 090308E-NF:T8430	● 0.8	■ 245	■ 0.19	■ 1.0	■ 135	■ 0.17	■ 1.0	■ 200	■ 0.19	■ 1.0	■ 675	■ 0.23	■ 1.0	■ 50	■ 0.15	■ 0.8	-	-	-
CNMG 090308E-NF:T9325	● 0.8	■ 300	■ 0.19	■ 1.0	■ 180	■ 0.17	■ 1.0	■ 285	■ 0.19	■ 1.0	-	-	-	■ 65	■ 0.15	■ 0.8	-	-	-
CNMG 120404E-NF:HF7	● 0.4	-	-	-	■ 95	■ 0.15	■ 1.7	■ 155	■ 0.17	■ 1.7	■ 495	■ 0.20	■ 1.7	-	-	-	-	-	-
CNMG 120404E-NF:T6310	● 0.4	■ 180	■ 0.17	■ 1.7	■ 125	■ 0.15	■ 1.7	■ 145	■ 0.17	■ 1.7	■ 540	■ 0.20	■ 1.7	■ 50	■ 0.14	■ 1.4	-	-	-
CNMG 120404E-NF:T7325	● 0.4	■ 200	■ 0.18	■ 1.7	■ 155	■ 0.16	■ 1.7	-	-	-	-	-	-	■ 65	■ 0.16	■ 1.4	-	-	-
CNMG 120404E-NF:T7335	● 0.4	■ 195	■ 0.18	■ 1.7	■ 150	■ 0.16	■ 1.7	-	-	-	-	-	-	■ 60	■ 0.16	■ 1.4	-	-	-
CNMG 120404E-NF:T8315	● 0.4	■ 185	■ 0.17	■ 1.7	■ 110	■ 0.15	■ 1.7	■ 175	■ 0.17	■ 1.7	■ 555	■ 0.20	■ 1.7	■ 45	■ 0.14	■ 1.4	-	-	-
CNMG 120404E-NF:T8430	● 0.4	■ 200	■ 0.17	■ 1.7	■ 110	■ 0.15	■ 1.7	■ 165	■ 0.17	■ 1.7	■ 555	■ 0.20	■ 1.7	■ 40	■ 0.14	■ 1.4	-	-	-
CNMG 120404E-NF:T9325	● 0.4	■ 250	■ 0.18	■ 1.7	■ 150	■ 0.16	■ 1.7	■ 235	■ 0.18	■ 1.7	-	-	-	■ 55	■ 0.16	■ 1.4	-	-	-
CNMG 120404E-NF:T9415	● 0.4	■ 315	■ 0.17	■ 1.7	-	-	-	■ 295	■ 0.17	■ 1.7	-	-	-	-	-	-	-	-	-
CNMG 120408E-NF:HF7	● 0.8	-	-	-	■ 110	■ 0.17	■ 1.7	■ 180	■ 0.19	■ 1.7	■ 570	■ 0.23	■ 1.7	-	-	-	-	-	-
CNMG 120408E-NF:T6310	● 0.8	■ 200	■ 0.19	■ 1.7	■ 140	■ 0.17	■ 1.7	■ 160	■ 0.19	■ 1.7	■ 600	■ 0.23	■ 1.7	■ 60	■ 0.15	■ 1.4	-	-	-
CNMG 120408E-NF:T7325	● 0.8	■ 235	■ 0.19	■ 1.7	■ 180	■ 0.17	■ 1.7	-	-	-	-	-	-	■ 75	■ 0.15	■ 1.4	-	-	-
CNMG 120408E-NF:T7335	● 0.8	■ 225	■ 0.19	■ 1.7	■ 175	■ 0.17	■ 1.7	-	-	-	-	-	-	■ 70	■ 0.15	■ 1.4	-	-	-
CNMG 120408E-NF:T8315	● 0.8	■ 215	■ 0.19	■ 1.7	■ 125	■ 0.17	■ 1.7	■ 200	■ 0.19	■ 1.7	■ 645	■ 0.23	■ 1.7	■ 50	■ 0.15	■ 1.4	-	-	-
CNMG 120408E-NF:T8430	● 0.8	■ 235	■ 0.19	■ 1.7	■ 125	■ 0.17	■ 1.7	■ 190	■ 0.19	■ 1.7	■ 645	■ 0.23	■ 1.7	■ 50	■ 0.15	■ 1.4	-	-	-
CNMG 120408E-NF:T9325	● 0.8	■ 285	■ 0.19	■ 1.7	■ 170	■ 0.17	■ 1.7	■ 270	■ 0.19	■ 1.7	-	-	-	■ 60	■ 0.15	■ 1.4	-	-	-
CNMG 120408E-NF:T9415	● 0.8	■ 360	■ 0.19	■ 1.7	-	-	-	■ 340	■ 0.19	■ 1.7	-	-	-	-	-	-	-	-	-
CNMG 120412E-NF:T6310	● 1.2	■ 185	■ 0.30	■ 2.1	■ 130	■ 0.27	■ 2.1	■ 145	■ 0.30	■ 2.1	■ 555	■ 0.36	■ 2.1	■ 55	■ 0.21	■ 1.7	-	-	-
CNMG 120412E-NF:T7325	● 1.2	■ 205	■ 0.30	■ 2.1	■ 155	■ 0.27	■ 2.1	-	-	-	-	-	-	■ 65	■ 0.21	■ 1.7	-	-	-
CNMG 120412E-NF:T7335	● 1.2	■ 200	■ 0.30	■ 2.1	■ 155	■ 0.27	■ 2.1	-	-	-	-	-	-	■ 65	■ 0.21	■ 1.7	-	-	-
CNMG 120412E-NF:T8430	● 1.2	■ 200	■ 0.30	■ 2.1	■ 110	■ 0.27	■ 2.1	■ 165	■ 0.30	■ 2.1	■ 555	■ 0.36	■ 2.1	■ 40	■ 0.21	■ 1.7	-	-	-
CNMG 120412E-NF:T9415	● 1.2	■ 315	■ 0.30	■ 2.1	-	-	-	■ 295	■ 0.30	■ 2.1	-	-	-	-	-	-	-	-	-

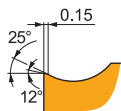

NF chip breaker is sharp and the first choice for fine-finishing of Steels, Stainless steels. It features highly positive rake angle and highly positive, narrow T-land. It's also conditionally suitable for Cast irons and Non-ferrous alloys and Super-alloy

DNMG 110404E-NF:T6310	● 0.4	■ 155	■ 0.15	■ 0.8	■ 110	■ 0.14	■ 0.8	■ 125	■ 0.15	■ 0.8	■ 465	■ 0.18	■ 0.8	■ 45	■ 0.12	■ 0.6	-	-	-
DNMG 110404E-NF:T7325	● 0.4	■ 170	■ 0.18	■ 0.8	■ 130	■ 0.16	■ 0.8	-	-	-	-	-	-	■ 55	■ 0.16	■ 0.6	-	-	-
DNMG 110404E-NF:T7335	● 0.4	■ 165	■ 0.18	■ 0.8	■ 125	■ 0.16	■ 0.8	-	-	-	-	-	-	■ 50	■ 0.16	■ 0.6	-	-	-
DNMG 110404E-NF:T8430	● 0.4	■ 190	■ 0.15	■ 0.8	■ 105	■ 0.14	■ 0.8	■ 155	■ 0.15	■ 0.8	■ 525	■ 0.18	■ 0.8	■ 40	■ 0.12	■ 0.6	-	-	-
DNMG 110404E-NF:T9325	● 0.4	■ 210	■ 0.18	■ 0.8	■ 125	■ 0.16	■ 0.8	■ 195	■ 0.18	■ 0.8	-	-	-	■ 45	■ 0.16	■ 0.6	-	-	-
DNMG 110408E-NF:T6310	● 0.8	■ 175	■ 0.17	■ 1.0	■ 125	■ 0.15	■ 1.0	■ 140	■ 0.17	■ 1.0	■ 525	■ 0.20	■ 1.0	■ 50	■ 0.14	■ 0.8	-	-	-
DNMG 110408E-NF:T7325	● 0.8	■ 200	■ 0.18	■ 1.0	■ 155	■ 0.16	■ 1.0	-	-	-	-	-	-	■ 65	■ 0.16	■ 0.8	-	-	-
DNMG 110408E-NF:T7335	● 0.8	■ 195	■ 0.18	■ 1.0	■ 150	■ 0.16	■ 1.0	-	-	-	-	-	-	■ 60	■ 0.16	■ 0.8	-	-	-
DNMG 110408E-NF:T8430	● 0.8	■ 205	■ 0.17	■ 1.0	■ 110	■ 0.15	■ 1.0	■ 170	■ 0.17	■ 1.0	■ 570	■ 0.20	■ 1.0	■ 45	■ 0.14	■ 0.8	-	-	-
DNMG 110408E-NF:T9325	● 0.8	■ 250	■ 0.18	■ 1.0	■ 150	■ 0.16	■ 1.0	■ 235	■ 0.18	■ 1.0	-	-	-	■ 55	■ 0.16	■ 0.8	-	-	-
DNMG 110408E-NF:T9415	● 0.8	■ 315	■ 0.17	■ 1.0	-	-	-	■ 295	■ 0.17	■ 1.0	-	-	-	-	-	-	-	-	-
DNMG 150404E-NF:T6310	● 0.4	■ 140	■ 0.17	■ 1.7	■ 100	■ 0.15	■ 1.7	■ 110	■ 0.17	■ 1.7	■ 420	■ 0.20	■ 1.7	■ 40	■ 0.15	■ 1.4	-	-	-
DNMG 150404E-NF:T7325	● 0.4	■ 160	■ 0.18	■ 1.7	■ 120	■ 0.16	■ 1.7	-	-	-	-	-	-	■ 50	■ 0.16	■ 1.4	-	-	-
DNMG 150404E-NF:T7335	● 0.4	■ 155	■ 0.18	■ 1.7	■ 120	■ 0.16	■ 1.7	-	-	-	-	-	-	■ 50	■ 0.16	■ 1.4	-	-	-
DNMG 150404E-NF:T8430	● 0.4	■ 165	■ 0.17	■ 1.7	■ 90	■ 0.15	■ 1.7	■ 135	■ 0.17	■ 1.7	■ 450	■ 0.20	■ 1.7	■ 35	■ 0.15	■ 1.4	-	-	-
DNMG 150404E-NF:T9325	● 0.4	■ 200	■ 0.18	■ 1.7	■ 120	■ 0.16	■ 1.7	■ 190	■ 0.18	■ 1.7	-	-	-	■ 45	■ 0.16	■ 1.4	-	-	-
DNMG 150404E-NF:T9415	● 0.4	■ 260	■ 0.15	■ 1.7	-	-	-	■ 245	■ 0.15	■ 1.7	-	-	-	-	-	-	-	-	-
DNMG 150408E-NF:T6310	● 0.8	■ 165	■ 0.18	■ 1.7	■ 115	■ 0.16	■ 1.7	■ 130	■ 0.18	■ 1.7	■ 495	■ 0.22	■ 1.7	■ 45	■ 0.16	■ 1.4	-	-	-
DNMG 150408E-NF:T7325	● 0.8	■ 190	■ 0.18	■ 1.7	■ 145	■ 0.16	■ 1.7	-	-	-	-	-	-	■ 60	■ 0.16	■ 1.4	-	-	-
DNMG 150408E-NF:T7335	● 0.8	■ 185	■ 0.18	■ 1.7	■ 140	■ 0.16	■ 1.7	-	-	-	-	-	-	■ 60	■ 0.16	■ 1.4	-	-	-
DNMG 150408E-NF:T8430	● 0.8	■ 190	■ 0.18	■ 1.7	■ 105	■ 0.16	■ 1.7	■ 155	■ 0.18	■ 1.7	■ 525	■ 0.22	■ 1.7	■ 40	■ 0.16	■ 1.4	-	-	-
DNMG 150408E-NF:T9325	● 0.8	■ 235	■ 0.18	■ 1.7	■ 140	■ 0.16	■ 1.7	■ 220	■ 0.18	■ 1.7	-	-	-	■ 50	■ 0.16	■ 1.4	-	-	-
DNMG 150408E-NF:T9415	● 0.8	■ 300	■ 0.17	■ 1.7	-	-	-	■ 285	■ 0.17	■ 1.7	-	-	-	-	-	-	-	-	-

Suitability and starting values for cutting speed (vc), feed (f) and depth of cut (ap). Refer to our Machining Calculator app for further calculations.

Product	RE (mm)	P			M			K			N			S			H		
		vc (m/min)	f (mm/rev)	ap (mm)	vc (m/min)	f (mm/rev)	ap (mm)	vc (m/min)	f (mm/rev)	ap (mm)	vc (m/min)	f (mm/rev)	ap (mm)	vc (m/min)	f (mm/rev)	ap (mm)	vc (m/min)	f (mm/rev)	ap (mm)

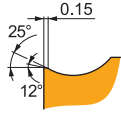

NF chip breaker is sharp and the first choice for fine-finishing of Steels, Stainless steels. It features highly positive rake angle and highly positive, narrow T-land. It's also conditionally suitable for Cast irons and Non-ferrous alloys and Super-alloy

DNMG 150604E-NF:HF7	● 0.4	–	–	–	■ 80	0.14	1.9	■ 130	0.15	1.9	■ 420	0.18	1.9	–	–	–	–	–	–
DNMG 150604E-NF:T6310	● 0.4	■ 140	0.17	1.9	■ 100	0.15	1.9	■ 110	0.17	1.9	■ 420	0.20	1.9	■ 40	0.15	1.5	–	–	–
DNMG 150604E-NF:T7325	● 0.4	■ 155	0.18	1.9	■ 120	0.16	1.9	–	–	–	–	–	–	■ 50	0.16	1.5	–	–	–
DNMG 150604E-NF:T7335	● 0.4	■ 150	0.18	1.9	■ 115	0.16	1.9	–	–	–	–	–	–	■ 45	0.16	1.5	–	–	–
DNMG 150604E-NF:T8315	● 0.4	■ 145	0.17	1.9	■ 85	0.15	1.9	■ 135	0.17	1.9	■ 435	0.20	1.9	■ 35	0.15	1.5	–	–	–
DNMG 150604E-NF:T8430	● 0.4	■ 165	0.17	1.9	■ 90	0.15	1.9	■ 135	0.17	1.9	■ 450	0.20	1.9	■ 35	0.15	1.5	–	–	–
DNMG 150604E-NF:T9325	● 0.4	■ 195	0.18	1.9	■ 115	0.16	1.9	■ 185	0.18	1.9	–	–	–	■ 40	0.16	1.5	–	–	–
DNMG 150604E-NF:T9415	● 0.4	■ 260	0.15	1.9	–	–	–	■ 245	0.15	1.9	–	–	–	–	–	–	–	–	–
DNMG 150608E-NF:HF7	● 0.8	–	–	–	■ 90	0.15	1.9	■ 145	0.17	1.9	■ 465	0.20	1.9	–	–	–	–	–	–
DNMG 150608E-NF:T6310	● 0.8	■ 165	0.18	1.9	■ 115	0.16	1.9	■ 130	0.18	1.9	■ 495	0.22	1.9	■ 45	0.16	1.5	–	–	–
DNMG 150608E-NF:T7325	● 0.8	■ 185	0.18	1.9	■ 140	0.16	1.9	–	–	–	–	–	–	■ 60	0.16	1.5	–	–	–
DNMG 150608E-NF:T7335	● 0.8	■ 180	0.18	1.9	■ 140	0.16	1.9	–	–	–	–	–	–	■ 55	0.16	1.5	–	–	–
DNMG 150608E-NF:T8315	● 0.8	■ 175	0.18	1.9	■ 105	0.16	1.9	■ 165	0.18	1.9	■ 525	0.22	1.9	■ 40	0.16	1.5	–	–	–
DNMG 150608E-NF:T8430	● 0.8	■ 190	0.18	1.9	■ 105	0.16	1.9	■ 155	0.18	1.9	■ 525	0.22	1.9	■ 40	0.16	1.5	–	–	–
DNMG 150608E-NF:T9325	● 0.8	■ 230	0.18	1.9	■ 135	0.16	1.9	■ 215	0.18	1.9	–	–	–	■ 50	0.16	1.5	–	–	–
DNMG 150608E-NF:T9415	● 0.8	■ 295	0.17	1.9	–	–	–	■ 280	0.17	1.9	–	–	–	–	–	–	–	–	–
DNMG 150612E-NF:T6310	● 1.2	■ 150	0.30	1.5	■ 105	0.27	1.5	■ 120	0.30	1.5	■ 450	0.36	1.5	■ 45	0.21	1.2	–	–	–
DNMG 150612E-NF:T8430	● 1.2	■ 165	0.30	1.5	■ 90	0.27	1.5	■ 135	0.30	1.5	■ 450	0.36	1.5	■ 35	0.21	1.2	–	–	–

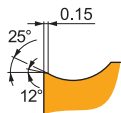
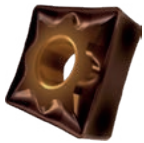

NF chip breaker is sharp and the first choice for fine-finishing of Steels, Stainless steels. It features highly positive rake angle and highly positive, narrow T-land. It's also conditionally suitable for Cast irons and Non-ferrous alloys and Super-alloy

SNMG 120404E-NF:T6310	● 0.4	■ 185	0.17	1.7	■ 130	0.15	1.7	■ 145	0.17	1.7	■ 555	0.20	1.7	■ 55	0.14	1.4	–	–	–
SNMG 120404E-NF:T7335	● 0.4	■ 205	0.18	1.7	■ 155	0.16	1.7	–	–	–	–	–	–	■ 65	0.16	1.4	–	–	–
SNMG 120404E-NF:T8430	● 0.4	■ 210	0.17	1.7	■ 115	0.15	1.7	■ 175	0.17	1.7	■ 585	0.20	1.7	■ 45	0.14	1.4	–	–	–
SNMG 120404E-NF:T9325	● 0.4	■ 260	0.18	1.7	■ 155	0.16	1.7	■ 245	0.18	1.7	–	–	–	■ 55	0.16	1.4	–	–	–
SNMG 120408E-NF:HF7	● 0.8	–	–	–	■ 120	0.17	1.7	■ 190	0.19	1.7	■ 600	0.23	1.7	–	–	–	–	–	–
SNMG 120408E-NF:T6310	● 0.8	■ 210	0.19	1.7	■ 150	0.17	1.7	■ 165	0.19	1.7	■ 630	0.23	1.7	■ 60	0.15	1.4	–	–	–
SNMG 120408E-NF:T7325	● 0.8	■ 245	0.19	1.7	■ 190	0.17	1.7	–	–	–	–	–	–	■ 75	0.15	1.4	–	–	–
SNMG 120408E-NF:T7335	● 0.8	■ 240	0.19	1.7	■ 185	0.17	1.7	–	–	–	–	–	–	■ 75	0.15	1.4	–	–	–
SNMG 120408E-NF:T8315	● 0.8	■ 230	0.19	1.7	■ 135	0.17	1.7	■ 215	0.19	1.7	■ 690	0.23	1.7	■ 55	0.15	1.4	–	–	–
SNMG 120408E-NF:T8430	● 0.8	■ 250	0.19	1.7	■ 135	0.17	1.7	■ 205	0.19	1.7	■ 690	0.23	1.7	■ 50	0.15	1.4	–	–	–
SNMG 120408E-NF:T9325	● 0.8	■ 300	0.19	1.7	■ 180	0.17	1.7	■ 285	0.19	1.7	–	–	–	■ 65	0.15	1.4	–	–	–

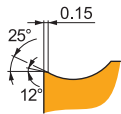
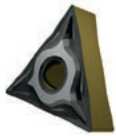

NF chip breaker is sharp and the first choice for fine-finishing of Steels, Stainless steels. It features highly positive rake angle and highly positive, narrow T-land. It's also conditionally suitable for Cast irons and Non-ferrous alloys and Super-alloy

TNMG 160404E-NF:HF7	● 0.4	–	–	–	■ 90	0.14	1.4	■ 140	0.15	1.4	■ 450	0.18	1.4	–	–	–	–	–	–
TNMG 160404E-NF:T6310	● 0.4	■ 150	0.17	1.4	■ 105	0.15	1.4	■ 120	0.17	1.4	■ 450	0.20	1.4	■ 45	0.15	1.1	–	–	–
TNMG 160404E-NF:T7325	● 0.4	■ 170	0.18	1.4	■ 130	0.16	1.4	–	–	–	–	–	–	■ 55	0.16	1.1	–	–	–
TNMG 160404E-NF:T7335	● 0.4	■ 165	0.18	1.4	■ 125	0.16	1.4	–	–	–	–	–	–	■ 50	0.16	1.1	–	–	–
TNMG 160404E-NF:T8315	● 0.4	■ 160	0.17	1.4	■ 95	0.15	1.4	■ 150	0.17	1.4	■ 480	0.20	1.4	■ 40	0.15	1.1	–	–	–
TNMG 160404E-NF:T8430	● 0.4	■ 175	0.17	1.4	■ 95	0.15	1.4	■ 140	0.17	1.4	■ 480	0.20	1.4	■ 35	0.15	1.1	–	–	–
TNMG 160404E-NF:T9325	● 0.4	■ 215	0.18	1.4	■ 125	0.16	1.4	■ 200	0.18	1.4	–	–	–	■ 45	0.16	1.1	–	–	–
TNMG 160404E-NF:T9415	● 0.4	■ 285	0.15	1.4	–	–	–	■ 270	0.15	1.4	–	–	–	–	–	–	–	–	–
TNMG 160408E-NF:HF7	● 0.8	–	–	–	■ 100	0.15	1.4	■ 160	0.17	1.4	■ 510	0.20	1.4	–	–	–	–	–	–
TNMG 160408E-NF:T6310	● 0.8	■ 180	0.18	1.4	■ 125	0.16	1.4	■ 145	0.18	1.4	■ 540	0.22	1.4	■ 50	0.16	1.1	–	–	–
TNMG 160408E-NF:T7325	● 0.8	■ 200	0.18	1.4	■ 155	0.16	1.4	–	–	–	–	–	–	■ 65	0.16	1.1	–	–	–
TNMG 160408E-NF:T7335	● 0.8	■ 195	0.18	1.4	■ 150	0.16	1.4	–	–	–	–	–	–	■ 60	0.16	1.1	–	–	–
TNMG 160408E-NF:T8315	● 0.8	■ 190	0.18	1.4	■ 110	0.16	1.4	■ 180	0.18	1.4	■ 570	0.22	1.4	■ 45	0.16	1.1	–	–	–
TNMG 160408E-NF:T8430	● 0.8	■ 205	0.18	1.4	■ 110	0.16	1.4	■ 170	0.18	1.4	■ 570	0.22	1.4	■ 45	0.16	1.1	–	–	–
TNMG 160408E-NF:T9325	● 0.8	■ 255	0.18	1.4	■ 150	0.16	1.4	■ 240	0.18	1.4	–	–	–	■ 55	0.16	1.1	–	–	–

Suitability and starting values for cutting speed (vc), feed (f) and depth of cut (ap). Refer to our Machining Calculator app for further calculations.

Product	RE (mm)	P			M			K			N			S			H		
		vc (m/min)	f (mm/rev)	ap (mm)	vc (m/min)	f (mm/rev)	ap (mm)	vc (m/min)	f (mm/rev)	ap (mm)	vc (m/min)	f (mm/rev)	ap (mm)	vc (m/min)	f (mm/rev)	ap (mm)	vc (m/min)	f (mm/rev)	ap (mm)

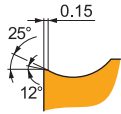

NF chip breaker is sharp and the first choice for fine-finishing of Steels, Stainless steels. It features highly positive rake angle and highly positive, narrow T-land. It's also conditionally suitable for Cast irons and Non-ferrous alloys and Super-alloy

VNMG 160404E-NF-T6310	● 0.4	■ 140	■ 0.12	■ 1.2	■ 100	■ 0.11	■ 1.2	■ 110	■ 0.12	■ 1.2	■ 420	■ 0.14	■ 1.2	■ 40	■ 0.11	■ 1.0	-	-	-
VNMG 160404E-NF-T7325	● 0.4	■ 140	■ 0.18	■ 1.2	■ 105	■ 0.16	■ 1.2	-	-	-	-	-	-	■ 45	■ 0.16	■ 1.0	-	-	-
VNMG 160404E-NF-T7335	● 0.4	■ 140	■ 0.18	■ 1.2	■ 105	■ 0.16	■ 1.2	-	-	-	-	-	-	■ 45	■ 0.16	■ 1.0	-	-	-
VNMG 160404E-NF-T8315	● 0.4	■ 150	■ 0.12	■ 1.2	■ 90	■ 0.11	■ 1.2	■ 140	■ 0.12	■ 1.2	■ 450	■ 0.14	■ 1.2	■ 35	■ 0.11	■ 1.0	-	-	-
VNMG 160404E-NF-T8430	● 0.4	■ 175	■ 0.12	■ 1.2	■ 95	■ 0.11	■ 1.2	■ 140	■ 0.12	■ 1.2	■ 480	■ 0.14	■ 1.2	■ 35	■ 0.11	■ 1.0	-	-	-
VNMG 160404E-NF-T9325	● 0.4	■ 180	■ 0.18	■ 1.2	■ 105	■ 0.16	■ 1.2	■ 170	■ 0.18	■ 1.2	-	-	-	■ 40	■ 0.16	■ 1.0	-	-	-
VNMG 160404E-NF-T9415	● 0.4	■ 255	■ 0.12	■ 1.2	-	-	-	■ 240	■ 0.12	■ 1.2	-	-	-	-	-	-	-	-	-
VNMG 160408E-NF-T6310	● 0.8	■ 145	■ 0.17	■ 1.4	■ 100	■ 0.15	■ 1.4	■ 115	■ 0.17	■ 1.4	■ 435	■ 0.20	■ 1.4	■ 40	■ 0.14	■ 1.1	-	-	-
VNMG 160408E-NF-T7325	● 0.8	■ 165	■ 0.18	■ 1.4	■ 125	■ 0.16	■ 1.4	-	-	-	-	-	-	■ 50	■ 0.16	■ 1.1	-	-	-
VNMG 160408E-NF-T7335	● 0.8	■ 160	■ 0.18	■ 1.4	■ 120	■ 0.16	■ 1.4	-	-	-	-	-	-	■ 50	■ 0.16	■ 1.1	-	-	-
VNMG 160408E-NF-T8315	● 0.8	■ 160	■ 0.17	■ 1.4	■ 95	■ 0.15	■ 1.4	■ 150	■ 0.17	■ 1.4	■ 480	■ 0.20	■ 1.4	■ 40	■ 0.14	■ 1.1	-	-	-
VNMG 160408E-NF-T8430	● 0.8	■ 175	■ 0.17	■ 1.4	■ 95	■ 0.15	■ 1.4	■ 140	■ 0.17	■ 1.4	■ 480	■ 0.20	■ 1.4	■ 35	■ 0.14	■ 1.1	-	-	-
VNMG 160408E-NF-T9325	● 0.8	■ 210	■ 0.18	■ 1.4	■ 125	■ 0.16	■ 1.4	■ 195	■ 0.18	■ 1.4	-	-	-	■ 45	■ 0.16	■ 1.1	-	-	-
VNMG 160408E-NF-T9415	● 0.8	■ 270	■ 0.17	■ 1.4	-	-	-	■ 255	■ 0.17	■ 1.4	-	-	-	-	-	-	-	-	-

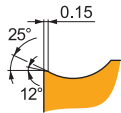
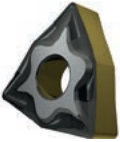

NF chip breaker is sharp and the first choice for fine-finishing of Steels, Stainless steels. It features highly positive rake angle and highly positive, narrow T-land. It's also conditionally suitable for Cast irons and Non-ferrous alloys and Super-alloy

WNMG 060404E-NF-T6310	● 0.4	■ 190	■ 0.17	■ 0.8	■ 135	■ 0.15	■ 0.8	■ 150	■ 0.17	■ 0.8	■ 570	■ 0.20	■ 0.8	■ 55	■ 0.12	■ 0.6	-	-	-
WNMG 060404E-NF-T7325	● 0.4	■ 215	■ 0.18	■ 0.8	■ 165	■ 0.16	■ 0.8	-	-	-	-	-	-	■ 65	■ 0.16	■ 0.6	-	-	-
WNMG 060404E-NF-T7335	● 0.4	■ 210	■ 0.18	■ 0.8	■ 160	■ 0.16	■ 0.8	-	-	-	-	-	-	■ 65	■ 0.16	■ 0.6	-	-	-
WNMG 060404E-NF-T8315	● 0.4	■ 200	■ 0.17	■ 0.8	■ 120	■ 0.15	■ 0.8	■ 190	■ 0.17	■ 0.8	■ 600	■ 0.20	■ 0.8	■ 50	■ 0.12	■ 0.6	-	-	-
WNMG 060404E-NF-T8430	● 0.4	■ 225	■ 0.17	■ 0.8	■ 120	■ 0.15	■ 0.8	■ 185	■ 0.17	■ 0.8	■ 615	■ 0.20	■ 0.8	■ 45	■ 0.12	■ 0.6	-	-	-
WNMG 060404E-NF-T9325	● 0.4	■ 265	■ 0.18	■ 0.8	■ 155	■ 0.16	■ 0.8	■ 250	■ 0.18	■ 0.8	-	-	-	■ 55	■ 0.16	■ 0.6	-	-	-
WNMG 060404E-NF-T9415	● 0.4	■ 340	■ 0.17	■ 0.8	-	-	-	■ 320	■ 0.17	■ 0.8	-	-	-	-	-	-	-	-	-
WNMG 060408E-NF-T6310	● 0.8	■ 215	■ 0.19	■ 1.0	■ 150	■ 0.17	■ 1.0	■ 170	■ 0.19	■ 1.0	■ 645	■ 0.23	■ 1.0	■ 60	■ 0.15	■ 0.8	-	-	-
WNMG 060408E-NF-T7325	● 0.8	■ 245	■ 0.19	■ 1.0	■ 190	■ 0.17	■ 1.0	-	-	-	-	-	-	■ 75	■ 0.15	■ 0.8	-	-	-
WNMG 060408E-NF-T8430	● 0.8	■ 245	■ 0.19	■ 1.0	■ 135	■ 0.17	■ 1.0	■ 200	■ 0.19	■ 1.0	■ 675	■ 0.23	■ 1.0	■ 50	■ 0.15	■ 0.8	-	-	-
WNMG 060408E-NF-T9325	● 0.8	■ 300	■ 0.19	■ 1.0	■ 180	■ 0.17	■ 1.0	■ 285	■ 0.19	■ 1.0	-	-	-	■ 65	■ 0.15	■ 0.8	-	-	-
WNMG 060408E-NF-T9415	● 0.8	■ 380	■ 0.19	■ 1.0	-	-	-	■ 360	■ 0.19	■ 1.0	-	-	-	-	-	-	-	-	-
WNMG 080404E-NF-HF7	● 0.4	-	-	-	■ 95	■ 0.15	■ 1.7	■ 155	■ 0.17	■ 1.7	■ 495	■ 0.20	■ 1.7	-	-	-	-	-	-
WNMG 080404E-NF-T6310	● 0.4	■ 180	■ 0.17	■ 1.7	■ 125	■ 0.15	■ 1.7	■ 145	■ 0.17	■ 1.7	■ 540	■ 0.20	■ 1.7	■ 50	■ 0.14	■ 1.4	-	-	-
WNMG 080404E-NF-T7325	● 0.4	■ 200	■ 0.18	■ 1.7	■ 155	■ 0.16	■ 1.7	-	-	-	-	-	-	■ 65	■ 0.16	■ 1.4	-	-	-
WNMG 080404E-NF-T7335	● 0.4	■ 195	■ 0.18	■ 1.7	■ 150	■ 0.16	■ 1.7	-	-	-	-	-	-	■ 60	■ 0.16	■ 1.4	-	-	-
WNMG 080404E-NF-T8315	● 0.4	■ 185	■ 0.17	■ 1.7	■ 110	■ 0.15	■ 1.7	■ 175	■ 0.17	■ 1.7	■ 555	■ 0.20	■ 1.7	■ 45	■ 0.14	■ 1.4	-	-	-
WNMG 080404E-NF-T8430	● 0.4	■ 200	■ 0.17	■ 1.7	■ 110	■ 0.15	■ 1.7	■ 165	■ 0.17	■ 1.7	■ 555	■ 0.20	■ 1.7	■ 40	■ 0.14	■ 1.4	-	-	-
WNMG 080404E-NF-T9325	● 0.4	■ 250	■ 0.18	■ 1.7	■ 150	■ 0.16	■ 1.7	■ 235	■ 0.18	■ 1.7	-	-	-	■ 55	■ 0.16	■ 1.4	-	-	-
WNMG 080408E-NF-HF7	● 0.8	-	-	-	■ 110	■ 0.17	■ 1.7	■ 180	■ 0.19	■ 1.7	■ 570	■ 0.23	■ 1.7	-	-	-	-	-	-
WNMG 080408E-NF-T6310	● 0.8	■ 200	■ 0.19	■ 1.7	■ 140	■ 0.17	■ 1.7	■ 160	■ 0.19	■ 1.7	■ 600	■ 0.23	■ 1.7	■ 60	■ 0.15	■ 1.4	-	-	-
WNMG 080408E-NF-T7325	● 0.8	■ 235	■ 0.19	■ 1.7	■ 180	■ 0.17	■ 1.7	-	-	-	-	-	-	■ 75	■ 0.15	■ 1.4	-	-	-
WNMG 080408E-NF-T7335	● 0.8	■ 225	■ 0.19	■ 1.7	■ 175	■ 0.17	■ 1.7	-	-	-	-	-	-	■ 70	■ 0.15	■ 1.4	-	-	-
WNMG 080408E-NF-T8315	● 0.8	■ 215	■ 0.19	■ 1.7	■ 125	■ 0.17	■ 1.7	■ 200	■ 0.19	■ 1.7	■ 645	■ 0.23	■ 1.7	■ 50	■ 0.15	■ 1.4	-	-	-
WNMG 080408E-NF-T8430	● 0.8	■ 235	■ 0.19	■ 1.7	■ 125	■ 0.17	■ 1.7	■ 190	■ 0.19	■ 1.7	■ 645	■ 0.23	■ 1.7	■ 50	■ 0.15	■ 1.4	-	-	-
WNMG 080408E-NF-T9325	● 0.8	■ 285	■ 0.19	■ 1.7	■ 170	■ 0.17	■ 1.7	■ 270	■ 0.19	■ 1.7	-	-	-	■ 60	■ 0.15	■ 1.4	-	-	-
WNMG 080408E-NF-T9415	● 0.8	■ 360	■ 0.19	■ 1.7	-	-	-	■ 340	■ 0.19	■ 1.7	-	-	-	-	-	-	-	-	-
WNMG 080412E-NF-T6310	● 1.2	■ 185	■ 0.30	■ 2.1	■ 130	■ 0.27	■ 2.1	■ 145	■ 0.30	■ 2.1	■ 555	■ 0.36	■ 2.1	■ 55	■ 0.21	■ 1.7	-	-	-
WNMG 080412E-NF-T7325	● 1.2	■ 205	■ 0.30	■ 2.1	■ 155	■ 0.27	■ 2.1	-	-	-	-	-	-	■ 65	■ 0.21	■ 1.7	-	-	-
WNMG 080412E-NF-T8430	● 1.2	■ 200	■ 0.30	■ 2.1	■ 110	■ 0.27	■ 2.1	■ 165	■ 0.30	■ 2.1	■ 555	■ 0.36	■ 2.1	■ 40	■ 0.21	■ 1.7	-	-	-
WNMG 080412E-NF-T9415	● 1.2	■ 315	■ 0.30	■ 2.1	-	-	-	■ 295	■ 0.30	■ 2.1	-	-	-	-	-	-	-	-	-

FF

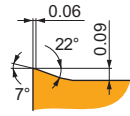

FF chip breaker is sharp and designed for fine-finishing of Steels, Stainless steels. It features positive rake angle and positive, thin T-land. It's also conditionally suitable for Cast irons.



CNMG

	IC (mm)	D1 (mm)	L (mm)	S (mm)
1204	12.700	5.16	12.90	4.76

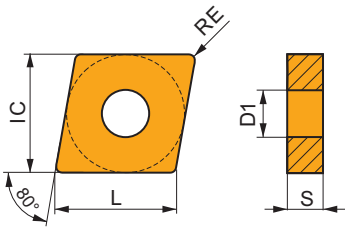

DNMG

	IC (mm)	D1 (mm)	L (mm)	S (mm)
1104	9.525	3.81	11.60	4.76
1504	12.700	5.16	15.50	4.76
1506	12.700	5.16	15.50	6.35

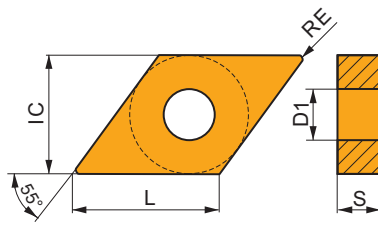

TNMG

	IC (mm)	D1 (mm)	L (mm)	S (mm)
1604	9.525	3.81	16.50	4.76

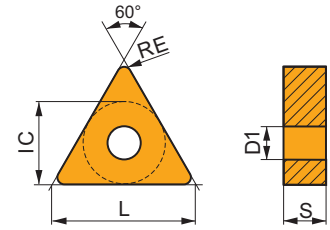

VNMG

	IC (mm)	D1 (mm)	L (mm)	S (mm)
1604	9.525	3.81	16.60	4.76

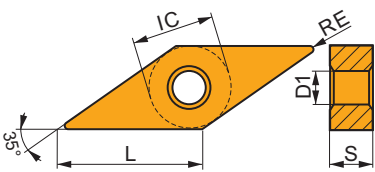

WNMG

	IC (mm)	D1 (mm)	L (mm)	S (mm)
0604	9.525	3.81	6.50	4.76
0804	12.700	5.16	8.70	4.76

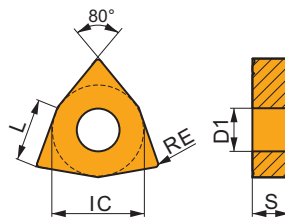

Suitability and starting values for cutting speed (vc), feed (f) and depth of cut (ap). Refer to our Machining Calculator app for further calculations.

Product	RE (mm)	P			M			K			N			S			H		
		vc (m/min)	f (mm/rev)	ap (mm)	vc (m/min)	f (mm/rev)	ap (mm)	vc (m/min)	f (mm/rev)	ap (mm)	vc (m/min)	f (mm/rev)	ap (mm)	vc (m/min)	f (mm/rev)	ap (mm)	vc (m/min)	f (mm/rev)	ap (mm)

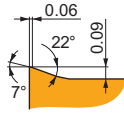
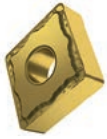

FF chip breaker is sharp and designed for fine-finishing of Steels, Stainless steels. It features positive rake angle and positive, thin T-land. It's also conditionally suitable for Cast irons.

CNMG 120404E-FF:T7325	● 0.4	✔ 235	0.12	1.0	■ 180	0.11	1.0	✘	✘	✘	✘	✘	✘	✘	✘	✘	✘	✘
CNMG 120404E-FF:T8315	● 0.4	✔ 220	0.12	1.0	■ 130	0.11	1.0	✔ 205	0.12	1.0	✘	✘	✘	✘	✘	✘	✘	✘
CNMG 120404E-FF:T8415	● 0.4	✔ 260	0.12	1.0	■ 135	0.11	1.0	✔ 240	0.12	1.0	✘	✘	✘	✘	✘	✘	✘	✘
CNMG 120408E-FF:T7325	● 0.8	✔ 265	0.15	1.0	■ 205	0.14	1.0	✘	✘	✘	✘	✘	✘	✘	✘	✘	✘	✘
CNMG 120408E-FF:T8315	● 0.8	✔ 245	0.15	1.0	■ 145	0.14	1.0	✔ 230	0.15	1.0	✘	✘	✘	✘	✘	✘	✘	✘
CNMG 120408E-FF:T8415	● 0.8	✔ 300	0.15	1.0	■ 155	0.14	1.0	✔ 270	0.15	1.0	✘	✘	✘	✘	✘	✘	✘	✘

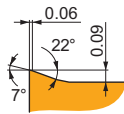

FF chip breaker is sharp and designed for fine-finishing of Steels, Stainless steels. It features positive rake angle and positive, thin T-land. It's also conditionally suitable for Cast irons.

DNMG 110402E-FF:T8315	● 0.2	✔ 175	0.10	0.8	■ 105	0.09	0.8	✔ 165	0.10	0.8	✘	✘	✘	✘	✘	✘	✘	✘
DNMG 110402E-FF:T8415	● 0.4	✔ 215	0.10	0.8	■ 110	0.09	0.8	✔ 195	0.10	0.8	✘	✘	✘	✘	✘	✘	✘	✘
DNMG 110404E-FF:T8315	● 0.4	✔ 175	0.12	0.8	■ 105	0.11	0.8	✔ 165	0.12	0.8	✘	✘	✘	✘	✘	✘	✘	✘
DNMG 110404E-FF:T8415	● 0.4	✔ 215	0.12	0.8	■ 110	0.11	0.8	✔ 195	0.12	0.8	✘	✘	✘	✘	✘	✘	✘	✘
DNMG 110404E-FF:T8430	● 0.4	✔ 205	0.12	0.8	■ 110	0.11	0.8	✔ 170	0.12	0.8	✘	✘	✘	✘	✘	✘	✘	✘
DNMG 110408E-FF:T8315	● 0.8	✔ 200	0.15	0.8	■ 120	0.14	0.8	✔ 190	0.15	0.8	✘	✘	✘	✘	✘	✘	✘	✘
DNMG 110408E-FF:T8415	● 0.4	✔ 240	0.15	0.8	■ 125	0.14	0.8	✔ 215	0.15	0.8	✘	✘	✘	✘	✘	✘	✘	✘
DNMG 150404E-FF:T8315	● 0.4	✔ 175	0.12	1.0	■ 105	0.11	1.0	✔ 165	0.12	1.0	✘	✘	✘	✘	✘	✘	✘	✘
DNMG 150604E-FF:T8315	● 0.4	✔ 175	0.12	1.0	■ 105	0.11	1.0	✔ 165	0.12	1.0	✘	✘	✘	✘	✘	✘	✘	✘
DNMG 150604E-FF:T8415	● 0.8	✔ 210	0.12	1.0	■ 110	0.11	1.0	✔ 190	0.12	1.0	✘	✘	✘	✘	✘	✘	✘	✘
DNMG 150608E-FF:T7325	● 0.8	✔ 210	0.15	1.0	■ 160	0.14	1.0	✘	✘	✘	✘	✘	✘	✘	✘	✘	✘	✘
DNMG 150608E-FF:T8315	● 0.8	✔ 195	0.15	1.0	■ 115	0.14	1.0	✔ 185	0.15	1.0	✘	✘	✘	✘	✘	✘	✘	✘
DNMG 150608E-FF:T8415	● 0.8	✔ 240	0.15	1.0	■ 125	0.14	1.0	✔ 215	0.15	1.0	✘	✘	✘	✘	✘	✘	✘	✘

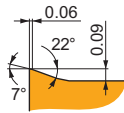

FF chip breaker is sharp and designed for fine-finishing of Steels, Stainless steels. It features positive rake angle and positive, thin T-land. It's also conditionally suitable for Cast irons.

TNMG 160404E-FF:T7325	● 0.4	✔ 200	0.12	1.0	■ 155	0.11	1.0	✘	✘	✘	✘	✘	✘	✘	✘	✘	✘	
TNMG 160404E-FF:T8315	● 0.4	✔ 185	0.12	1.0	■ 110	0.11	1.0	✔ 175	0.12	1.0	✘	✘	✘	✘	✘	✘	✘	
TNMG 160404E-FF:T8415	● 0.4	✔ 225	0.12	1.0	■ 115	0.11	1.0	✔ 205	0.12	1.0	✘	✘	✘	✘	✘	✘	✘	
TNMG 160404E-FF:T8430	● 0.4	✔ 210	0.12	1.0	■ 115	0.11	1.0	✔ 175	0.12	1.0	✘	✘	✘	✘	✘	✘	✘	✘
TNMG 160408E-FF:T8315	● 0.8	✔ 205	0.15	1.0	■ 120	0.14	1.0	✔ 190	0.15	1.0	✘	✘	✘	✘	✘	✘	✘	✘
TNMG 160408E-FF:T8415	● 0.8	✔ 250	0.15	1.0	■ 130	0.14	1.0	✔ 225	0.15	1.0	✘	✘	✘	✘	✘	✘	✘	✘

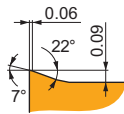

FF chip breaker is sharp and designed for fine-finishing of Steels, Stainless steels. It features positive rake angle and positive, thin T-land. It's also conditionally suitable for Cast irons.



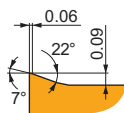





VNMG 160404E-FF:T7325	● 0.4	✔ 165	0.12	1.0	■ 125	0.11	1.0	✘	✘	✘	✘	✘	✘	✘	✘	✘	✘
VNMG 160404E-FF:T8315	● 0.4	✔ 150	0.12	1.0	■ 90	0.11	1.0	✔ 140	0.12	1.0	✘	✘	✘	✘	✘	✘	✘
VNMG 160404E-FF:T8415	● 0.4	✔ 185	0.12	1.0	■ 95	0.11	1.0	✔ 165	0.12	1.0	✘	✘	✘	✘	✘	✘	✘
VNMG 160404E-FF:T8430	● 0.4	✔ 175	0.12	1.0	■ 95	0.11	1.0	✔ 140	0.12	1.0	✘	✘	✘	✘	✘	✘	✘

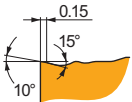

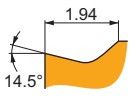
FF chip breaker is sharp and designed for fine-finishing of Steels, Stainless steels. It features positive rake angle and positive, thin T-land. It's also conditionally suitable for Cast irons.

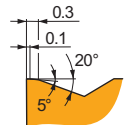
WNMG 060402E-FF:T8315	● 0.2	✔ 215	0.10	1.0	■ 125	0.09	1.0	✔ 200	0.10	1.0	✘	✘	✘	✘	✘	✘	✘
WNMG 060402E-FF:T8415	● 0.2	✔ 260	0.10	1.0	■ 135	0.09	1.0	✔ 240	0.10	1.0	✘	✘	✘	✘	✘	✘	✘
WNMG 060404E-FF:T8315	● 0.4	✔ 220	0.12	1.0	■ 130	0.11	1.0	✔ 205	0.12	1.0	✘	✘	✘	✘	✘	✘	✘
WNMG 060404E-FF:T8415	● 0.4	✔ 260	0.12	1.0	■ 135	0.11	1.0	✔ 240	0.12	1.0	✘	✘	✘	✘	✘	✘	✘
WNMG 080404E-FF:T7325	● 0.4	✔ 235	0.12	1.0	■ 180	0.11	1.0	✘	✘	✘	✘	✘	✘	✘	✘	✘	✘
WNMG 080404E-FF:T8315	● 0.4	✔ 220	0.12	1.0	■ 130	0.11	1.0	✔ 205	0.12	1.0	✘	✘	✘	✘	✘	✘	✘
WNMG 080404E-FF:T8415	● 0.4	✔ 260	0.12	1.0	■ 135	0.11	1.0	✔ 240	0.12	1.0	✘	✘	✘	✘	✘	✘	✘
WNMG 080408E-FF:T7325	● 0.8	✔ 265	0.15	1.0	■ 205	0.14	1.0	✘	✘	✘	✘	✘	✘	✘	✘	✘	✘
WNMG 080408E-FF:T8315	● 0.8	✔ 245	0.15	1.0	■ 145	0.14	1.0	✔ 230	0.15	1.0	✘	✘	✘	✘	✘	✘	✘
WNMG 080408E-FF:T8415	● 0.8	✔ 300	0.15	1.0	■ 155	0.14	1.0	✔ 270	0.15	1.0	✘	✘	✘	✘	✘	✘	✘

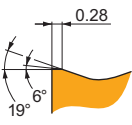
FINISHING – NAVIGATOR

<p>FM</p>			<p>FM chip breaker is versatile and the first choice for finishing of Steels and Cast irons. It features slightly positive rake angle and positive, narrow T-land. It's also conditionally suitable for Stainless steels and Super-alloys.</p>
<p>SF</p>			<p>SF chip breaker is sharp and the first choice for finishing of Stainless steels and Super-alloys. It features slightly positive rake angle without T-land. It's also suitable for Steels, Cast irons and Hard materials, and conditionally for Non-ferrous alloys.</p>
<p>W-M</p>			<p>W-M chip breaker has wiper edge and is designed for finishing of Steels. It features positive rake angle and positive, moderate T-land. It's also conditionally suitable for Cast irons.</p>
<p>W-MR</p>			<p>W-MR chip breaker has wiper edge and is designed for finishing of Steels. It features positive rake angle and stable, wide T-land. It's also conditionally suitable for Stainless steels and Cast irons.</p>

FM

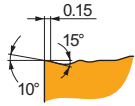

FM chip breaker is versatile and the first choice for finishing of Steels and Cast irons. It features slightly positive rake angle and positive, narrow T-land. It's also conditionally suitable for Stainless steels and Super-alloys.



CNMG

	IC (mm)	D1 (mm)	L (mm)	S (mm)
0903	9.525	3.81	9.70	3.18
1204	12.700	5.16	12.90	4.76

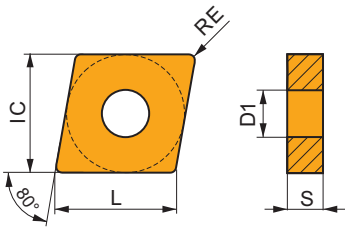

DNMG

	IC (mm)	D1 (mm)	L (mm)	S (mm)
1104	9.525	3.81	11.60	4.76
1504	12.700	5.16	15.50	4.76
1506	12.700	5.16	15.50	6.35

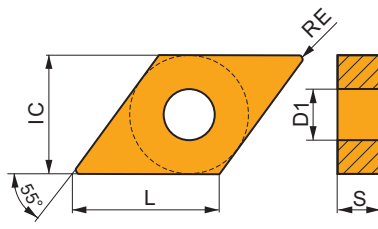

SNMG

	IC (mm)	D1 (mm)	L (mm)	S (mm)
1204	12.700	5.16	12.70	4.76

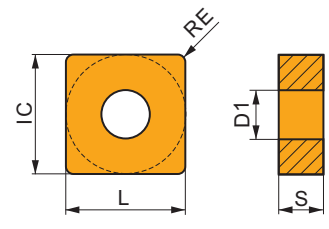

TNMG

	IC (mm)	D1 (mm)	L (mm)	S (mm)
1604	9.525	3.81	16.50	4.76
2204	12.700	5.16	22.00	4.76

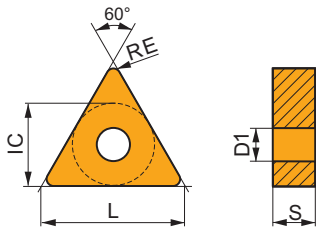

VNMG

	IC (mm)	D1 (mm)	L (mm)	S (mm)
1604	9.525	3.81	16.60	4.76

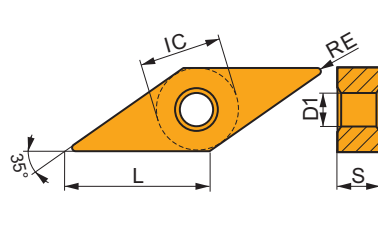

WNMG

	IC (mm)	D1 (mm)	L (mm)	S (mm)
0604	9.525	3.81	6.50	4.76
06T3	9.525	3.81	6.50	3.97
0804	12.700	5.16	8.70	4.76

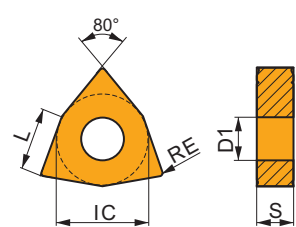

Suitability and starting values for cutting speed (vc), feed (f) and depth of cut (ap). Refer to our Machining Calculator app for further calculations.

Product	RE (mm)	P			M			K			N			S			H		
		vc (m/min)	f (mm/rev)	ap (mm)	vc (m/min)	f (mm/rev)	ap (mm)	vc (m/min)	f (mm/rev)	ap (mm)	vc (m/min)	f (mm/rev)	ap (mm)	vc (m/min)	f (mm/rev)	ap (mm)	vc (m/min)	f (mm/rev)	ap (mm)

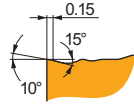
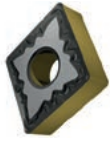

FM chip breaker is versatile and the first choice for finishing of Steels and Cast irons. It features slightly positive rake angle and positive, narrow T-land. It's also conditionally suitable for Stainless steels and Super-alloys.

CNMG 090304E-FM:T8430	●	0.4	195	0.20	1.4	105	0.18	1.4	160	0.20	1.4	—	—	—	40	0.14	1.1	—	—	—
CNMG 090304E-FM:T9325	●	0.4	240	0.20	1.4	140	0.18	1.4	225	0.20	1.4	—	—	—	50	0.16	1.1	—	—	—
CNMG 090304E-FM:T9415	●	0.4	305	0.20	1.4	—	—	—	285	0.20	1.4	—	—	—	—	—	—	—	—	—
CNMG 090308E-FM:T8430	⊕	0.8	235	0.20	1.4	125	0.18	1.4	190	0.20	1.4	—	—	—	50	0.14	1.1	—	—	—
CNMG 090308E-FM:T9325	●	0.8	285	0.20	1.4	170	0.18	1.4	270	0.20	1.4	—	—	—	60	0.16	1.1	—	—	—
CNMG 090308E-FM:T9415	●	0.8	365	0.20	1.4	—	—	—	345	0.20	1.4	—	—	—	—	—	—	—	—	—
CNMG 120404E-FM:T7325	●	0.4	185	0.20	2.1	140	0.18	2.1	—	—	—	—	—	—	60	0.16	1.7	—	—	—
CNMG 120404E-FM:T7335	●	0.4	180	0.20	2.1	140	0.18	2.1	—	—	—	—	—	—	55	0.16	1.7	—	—	—
CNMG 120404E-FM:T8315	●	0.4	175	0.20	2.1	105	0.18	2.1	165	0.20	2.1	—	—	—	40	0.14	1.7	—	—	—
CNMG 120404E-FM:T8415	●	0.4	215	0.20	2.1	110	0.18	2.1	195	0.20	2.1	—	—	—	45	0.14	1.7	—	—	—
CNMG 120404E-FM:T8430	●	0.4	190	0.20	2.1	105	0.18	2.1	155	0.20	2.1	—	—	—	40	0.14	1.7	—	—	—
CNMG 120404E-FM:T9325	●	0.4	230	0.20	2.1	135	0.18	2.1	215	0.20	2.1	—	—	—	50	0.16	1.7	—	—	—
CNMG 120404E-FM:T9415	●	0.4	290	0.20	2.1	—	—	—	275	0.20	2.1	—	—	—	—	—	—	—	—	—
CNMG 120404E-FM:TT310	●	0.4	260	0.20	2.1	155	0.18	2.1	—	—	—	—	—	—	—	—	—	—	—	—
CNMG 120408E-FM:T7325	⊕	0.8	220	0.20	2.1	170	0.18	2.1	—	—	—	—	—	—	70	0.16	1.7	—	—	—
CNMG 120408E-FM:T7335	⊕	0.8	215	0.20	2.1	165	0.18	2.1	—	—	—	—	—	—	65	0.16	1.7	—	—	—
CNMG 120408E-FM:T8315	⊕	0.8	205	0.20	2.1	120	0.18	2.1	190	0.20	2.1	—	—	—	50	0.16	1.7	—	—	—
CNMG 120408E-FM:T8415	⊕	0.8	250	0.20	2.1	130	0.18	2.1	225	0.20	2.1	—	—	—	55	0.16	1.7	—	—	—
CNMG 120408E-FM:T8430	⊕	0.8	225	0.20	2.1	120	0.18	2.1	185	0.20	2.1	—	—	—	45	0.16	1.7	—	—	—
CNMG 120408E-FM:T9310	●	0.8	335	0.20	2.1	—	—	—	315	0.20	2.1	—	—	—	—	—	—	—	—	—
CNMG 120408E-FM:T9315	●	0.8	305	0.20	2.1	—	—	—	285	0.20	2.1	—	—	—	—	—	—	—	—	—
CNMG 120408E-FM:T9325	●	0.8	275	0.20	2.1	165	0.18	2.1	260	0.20	2.1	—	—	—	60	0.16	1.7	—	—	—
CNMG 120408E-FM:T9415	●	0.8	350	0.20	2.1	—	—	—	330	0.20	2.1	—	—	—	—	—	—	—	—	—
CNMG 120408E-FM:TT310	●	0.8	310	0.20	2.1	185	0.18	2.1	—	—	—	—	—	—	—	—	—	—	—	—
CNMG 120412E-FM:T7325	⊕	1.2	210	0.27	2.1	160	0.24	2.1	—	—	—	—	—	—	65	0.19	1.7	—	—	—
CNMG 120412E-FM:T9325	⊕	1.2	255	0.27	2.1	150	0.24	2.1	240	0.27	2.1	—	—	—	55	0.19	1.7	—	—	—
CNMG 120412E-FM:T9415	⊕	1.2	330	0.27	2.1	—	—	—	310	0.27	2.1	—	—	—	—	—	—	—	—	—

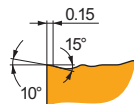

FM chip breaker is versatile and the first choice for finishing of Steels and Cast irons. It features slightly positive rake angle and positive, narrow T-land. It's also conditionally suitable for Stainless steels and Super-alloys.

DNMG 110404E-FM:T8315	●	0.4	150	0.20	0.8	90	0.18	0.8	140	0.20	0.8	—	—	—	35	0.14	0.6	—	—	—
DNMG 110404E-FM:T8415	●	0.4	185	0.20	0.8	95	0.18	0.8	165	0.20	0.8	—	—	—	40	0.14	0.6	—	—	—
DNMG 110404E-FM:T8430	●	0.4	165	0.20	0.8	90	0.18	0.8	135	0.20	0.8	—	—	—	35	0.14	0.6	—	—	—
DNMG 110404E-FM:T9325	●	0.4	200	0.20	0.8	120	0.18	0.8	190	0.20	0.8	—	—	—	45	0.20	0.6	—	—	—
DNMG 110404E-FM:T9415	●	0.4	260	0.20	0.8	—	—	—	245	0.20	0.8	—	—	—	—	—	—	—	—	—
DNMG 110408E-FM:T7325	●	0.8	200	0.20	0.8	155	0.18	0.8	—	—	—	—	—	—	65	0.16	0.6	—	—	—
DNMG 110408E-FM:T8315	●	0.8	180	0.20	0.8	105	0.18	0.8	170	0.20	0.8	—	—	—	45	0.14	0.6	—	—	—
DNMG 110408E-FM:T8415	●	0.8	220	0.20	0.8	115	0.18	0.8	200	0.20	0.8	—	—	—	50	0.14	0.6	—	—	—
DNMG 110408E-FM:T8430	●	0.8	195	0.20	0.8	105	0.18	0.8	160	0.20	0.8	—	—	—	40	0.14	0.6	—	—	—
DNMG 110408E-FM:T9310	●	0.8	295	0.20	0.8	—	—	—	280	0.20	0.8	—	—	—	—	—	—	—	—	—
DNMG 110408E-FM:T9325	●	0.8	240	0.20	0.8	140	0.18	0.8	225	0.20	0.8	—	—	—	50	0.16	0.6	—	—	—
DNMG 110408E-FM:T9415	●	0.8	305	0.20	0.8	—	—	—	285	0.20	0.8	—	—	—	—	—	—	—	—	—
DNMG 150404E-FM:T7325	●	0.4	150	0.20	1.7	115	0.18	1.7	—	—	—	—	—	—	45	0.20	1.4	—	—	—
DNMG 150404E-FM:T8430	●	0.4	150	0.20	1.7	80	0.18	1.7	125	0.20	1.7	—	—	—	30	0.14	1.4	—	—	—
DNMG 150404E-FM:T9325	●	0.4	190	0.20	1.7	110	0.18	1.7	180	0.20	1.7	—	—	—	40	0.20	1.4	—	—	—
DNMG 150404E-FM:T9415	●	0.4	235	0.20	1.7	—	—	—	220	0.20	1.7	—	—	—	—	—	—	—	—	—
DNMG 150408E-FM:T7325	●	0.8	180	0.20	1.7	140	0.18	1.7	—	—	—	—	—	—	55	0.16	1.4	—	—	—
DNMG 150408E-FM:T8430	●	0.8	185	0.20	1.7	100	0.18	1.7	150	0.20	1.7	—	—	—	40	0.16	1.4	—	—	—
DNMG 150408E-FM:T9325	●	0.8	225	0.20	1.7	135	0.18	1.7	210	0.20	1.7	—	—	—	50	0.16	1.4	—	—	—
DNMG 150408E-FM:T9415	●	0.8	280	0.20	1.7	—	—	—	265	0.20	1.7	—	—	—	—	—	—	—	—	—

Suitability and starting values for cutting speed (vc), feed (f) and depth of cut (ap). Refer to our Machining Calculator app for further calculations.

Product	RE (mm)	P			M			K			N			S			H		
		vc (m/min)	f (mm/rev)	ap (mm)	vc (m/min)	f (mm/rev)	ap (mm)	vc (m/min)	f (mm/rev)	ap (mm)	vc (m/min)	f (mm/rev)	ap (mm)	vc (m/min)	f (mm/rev)	ap (mm)	vc (m/min)	f (mm/rev)	ap (mm)

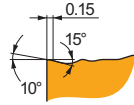

FM chip breaker is versatile and the first choice for finishing of Steels and Cast irons. It features slightly positive rake angle and positive, narrow T-land. It's also conditionally suitable for Stainless steels and Super-alloys.

DNMG 150604E-FM:T7325	● 0.4	150	0.20	1.7	115	0.18	1.7	—	—	—	—	—	—	45	0.20	1.4	—	—	—
DNMG 150604E-FM:T7335	● 0.4	150	0.20	1.7	115	0.18	1.7	—	—	—	—	—	—	45	0.20	1.4	—	—	—
DNMG 150604E-FM:T8315	● 0.4	140	0.20	1.7	80	0.18	1.7	130	0.20	1.7	—	—	—	35	0.14	1.4	—	—	—
DNMG 150604E-FM:T8415	● 0.4	170	0.20	1.7	90	0.18	1.7	155	0.20	1.7	—	—	—	35	0.14	1.4	—	—	—
DNMG 150604E-FM:T8430	● 0.4	150	0.20	1.7	80	0.18	1.7	125	0.20	1.7	—	—	—	30	0.14	1.4	—	—	—
DNMG 150604E-FM:T9310	● 0.4	230	0.20	1.7	—	—	—	215	0.20	1.7	—	—	—	—	—	—	—	—	—
DNMG 150604E-FM:T9315	● 0.4	210	0.20	1.7	—	—	—	195	0.20	1.7	—	—	—	—	—	—	—	—	—
DNMG 150604E-FM:T9325	● 0.4	190	0.20	1.7	110	0.18	1.7	180	0.20	1.7	—	—	—	40	0.20	1.4	—	—	—
DNMG 150604E-FM:T9415	● 0.4	235	0.20	1.7	—	—	—	220	0.20	1.7	—	—	—	—	—	—	—	—	—
DNMG 150608E-FM:T7325	● 0.8	180	0.20	1.7	140	0.18	1.7	—	—	—	—	—	—	55	0.16	1.4	—	—	—
DNMG 150608E-FM:T7335	● 0.8	175	0.20	1.7	135	0.18	1.7	—	—	—	—	—	—	55	0.16	1.4	—	—	—
DNMG 150608E-FM:T8315	● 0.8	170	0.20	1.7	100	0.18	1.7	160	0.20	1.7	—	—	—	40	0.16	1.4	—	—	—
DNMG 150608E-FM:T8415	● 0.8	210	0.20	1.7	110	0.18	1.7	190	0.20	1.7	—	—	—	45	0.16	1.4	—	—	—
DNMG 150608E-FM:T8430	● 0.8	185	0.20	1.7	100	0.18	1.7	150	0.20	1.7	—	—	—	40	0.16	1.4	—	—	—
DNMG 150608E-FM:T9310	● 0.8	275	0.20	1.7	—	—	—	260	0.20	1.7	—	—	—	—	—	—	—	—	—
DNMG 150608E-FM:T9315	● 0.8	250	0.20	1.7	—	—	—	235	0.20	1.7	—	—	—	—	—	—	—	—	—
DNMG 150608E-FM:T9325	● 0.8	225	0.20	1.7	135	0.18	1.7	210	0.20	1.7	—	—	—	50	0.16	1.4	—	—	—
DNMG 150608E-FM:T9415	● 0.8	280	0.20	1.7	—	—	—	265	0.20	1.7	—	—	—	—	—	—	—	—	—
DNMG 150612E-FM:T7325	● 1.2	180	0.25	1.7	140	0.23	1.7	—	—	—	—	—	—	55	0.18	1.4	—	—	—
DNMG 150612E-FM:T8430	● 1.2	175	0.25	1.7	95	0.23	1.7	140	0.25	1.7	—	—	—	35	0.18	1.4	—	—	—
DNMG 150612E-FM:T9315	● 1.2	240	0.25	1.7	—	—	—	225	0.25	1.7	—	—	—	—	—	—	—	—	—
DNMG 150612E-FM:T9325	● 1.2	215	0.25	1.7	125	0.23	1.7	200	0.25	1.7	—	—	—	45	0.18	1.4	—	—	—
DNMG 150612E-FM:T9415	● 1.2	275	0.25	1.7	—	—	—	260	0.25	1.7	—	—	—	—	—	—	—	—	—
DNMG 150616E-FM:T9315	● 1.6	235	0.30	1.7	—	—	—	220	0.30	1.7	—	—	—	—	—	—	—	—	—
DNMG 150616E-FM:T9325	● 1.6	210	0.30	1.7	125	0.27	1.7	195	0.30	1.7	—	—	—	45	0.21	1.4	—	—	—
DNMG 150616E-FM:T9415	● 1.6	270	0.30	1.7	—	—	—	255	0.30	1.7	—	—	—	—	—	—	—	—	—

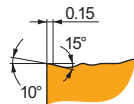
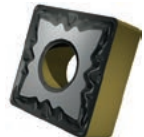

FM chip breaker is versatile and the first choice for finishing of Steels and Cast irons. It features slightly positive rake angle and positive, narrow T-land. It's also conditionally suitable for Stainless steels and Super-alloys.

SNMG 120404E-FM:T6310	● 0.4	175	0.20	2.1	125	0.18	2.1	140	0.20	2.1	—	—	—	50	0.14	1.7	—	—	—
SNMG 120404E-FM:T7325	● 0.4	195	0.20	2.1	150	0.18	2.1	—	—	—	—	—	—	60	0.16	1.7	—	—	—
SNMG 120404E-FM:T8315	● 0.4	180	0.20	2.1	105	0.18	2.1	170	0.20	2.1	—	—	—	45	0.14	1.7	—	—	—
SNMG 120404E-FM:T8415	● 0.4	220	0.20	2.1	115	0.18	2.1	200	0.20	2.1	—	—	—	50	0.14	1.7	—	—	—
SNMG 120404E-FM:T8430	● 0.4	195	0.20	2.1	105	0.18	2.1	160	0.20	2.1	—	—	—	40	0.14	1.7	—	—	—
SNMG 120404E-FM:T9325	● 0.4	240	0.20	2.1	140	0.18	2.1	225	0.20	2.1	—	—	—	50	0.16	1.7	—	—	—
SNMG 120404E-FM:T9415	● 0.4	305	0.20	2.1	—	—	—	285	0.20	2.1	—	—	—	—	—	—	—	—	—
SNMG 120408E-FM:T7325	● 0.8	235	0.20	2.1	180	0.18	2.1	—	—	—	—	—	—	75	0.16	1.7	—	—	—
SNMG 120408E-FM:T8315	● 0.8	215	0.20	2.1	125	0.18	2.1	200	0.20	2.1	—	—	—	50	0.16	1.7	—	—	—
SNMG 120408E-FM:T8415	● 0.8	260	0.20	2.1	135	0.18	2.1	240	0.20	2.1	—	—	—	60	0.16	1.7	—	—	—
SNMG 120408E-FM:T8430	● 0.8	235	0.20	2.1	125	0.18	2.1	190	0.20	2.1	—	—	—	50	0.16	1.7	—	—	—
SNMG 120408E-FM:T9325	● 0.8	290	0.20	2.1	170	0.18	2.1	275	0.20	2.1	—	—	—	65	0.16	1.7	—	—	—
SNMG 120408E-FM:T9415	● 0.8	365	0.20	2.1	—	—	—	345	0.20	2.1	—	—	—	—	—	—	—	—	—
SNMG 120412E-FM:T8430	● 1.2	220	0.27	2.1	120	0.24	2.1	180	0.27	2.1	—	—	—	45	0.19	1.7	—	—	—
SNMG 120412E-FM:T9325	● 1.2	270	0.27	2.1	160	0.24	2.1	255	0.27	2.1	—	—	—	60	0.19	1.7	—	—	—
SNMG 120412E-FM:T9415	● 1.2	345	0.27	2.1	—	—	—	325	0.27	2.1	—	—	—	—	—	—	—	—	—
SNMG 120416E-FM:T8430	● 1.6	220	0.32	2.1	120	0.29	2.1	180	0.32	2.1	—	—	—	45	0.22	1.7	—	—	—

Suitability and starting values for cutting speed (vc), feed (f) and depth of cut (ap). Refer to our Machining Calculator app for further calculations.

Product	RE (mm)	P			M			K			N			S			H		
		vc (m/min)	f (mm/rev)	ap (mm)	vc (m/min)	f (mm/rev)	ap (mm)	vc (m/min)	f (mm/rev)	ap (mm)	vc (m/min)	f (mm/rev)	ap (mm)	vc (m/min)	f (mm/rev)	ap (mm)	vc (m/min)	f (mm/rev)	ap (mm)

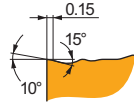
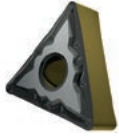

FM chip breaker is versatile and the first choice for finishing of Steels and Cast irons. It features slightly positive rake angle and positive, narrow T-land. It's also conditionally suitable for Stainless steels and Super-alloys.

TNMG 160404E-FM-T7325	● 0.4	✓	160	0.20	1.7	✓	120	0.18	1.7	—	—	—	—	—	—	✓	50	0.20	1.4	—	—	—	
TNMG 160404E-FM-T7335	● 0.4	✓	160	0.20	1.7	✓	120	0.18	1.7	—	—	—	—	—	—	✓	50	0.20	1.4	—	—	—	
TNMG 160404E-FM-T8315	● 0.4	✓	150	0.20	1.7	✓	90	0.18	1.7	■	140	0.20	1.7	—	—	—	✓	35	0.14	1.4	—	—	—
TNMG 160404E-FM-T8415	● 0.4	■	185	0.20	1.7	✓	95	0.18	1.7	■	165	0.20	1.7	—	—	—	✓	40	0.14	1.4	—	—	—
TNMG 160404E-FM-T8430	● 0.4	■	165	0.20	1.7	✓	90	0.18	1.7	✓	135	0.20	1.7	—	—	—	✓	35	0.14	1.4	—	—	—
TNMG 160404E-FM-T9325	● 0.4	■	200	0.20	1.7	✓	120	0.18	1.7	✓	190	0.20	1.7	—	—	—	✓	45	0.20	1.4	—	—	—
TNMG 160404E-FM-T9415	● 0.4	■	250	0.20	1.7	—	—	—	—	✓	235	0.20	1.7	—	—	—	—	—	—	—	—	—	—
TNMG 160404E-FM-TT310	● 0.4	■	225	0.20	1.7	✓	135	0.18	1.7	—	—	—	—	—	—	—	—	—	—	—	—	—	—
TNMG 160408E-FM-T7325	● 0.8	✓	195	0.20	1.7	✓	150	0.18	1.7	—	—	—	—	—	—	✓	60	0.16	1.4	—	—	—	
TNMG 160408E-FM-T7335	● 0.8	✓	190	0.20	1.7	✓	145	0.18	1.7	—	—	—	—	—	—	✓	60	0.16	1.4	—	—	—	
TNMG 160408E-FM-T8315	● 0.8	✓	180	0.20	1.7	✓	105	0.18	1.7	■	170	0.20	1.7	—	—	—	✓	45	0.16	1.4	—	—	—
TNMG 160408E-FM-T8415	● 0.8	■	220	0.20	1.7	✓	115	0.18	1.7	■	200	0.20	1.7	—	—	—	✓	50	0.16	1.4	—	—	—
TNMG 160408E-FM-T8430	● 0.8	■	195	0.20	1.7	✓	105	0.18	1.7	✓	160	0.20	1.7	—	—	—	✓	40	0.16	1.4	—	—	—
TNMG 160408E-FM-T9310	● 0.8	■	290	0.20	1.7	—	—	—	—	✓	275	0.20	1.7	—	—	—	—	—	—	—	—	—	—
TNMG 160408E-FM-T9325	● 0.8	■	235	0.20	1.7	✓	140	0.18	1.7	✓	220	0.20	1.7	—	—	—	✓	50	0.16	1.4	—	—	—
TNMG 160408E-FM-T9415	● 0.8	■	300	0.20	1.7	—	—	—	—	✓	285	0.20	1.7	—	—	—	—	—	—	—	—	—	—
TNMG 160408E-FM-TT310	● 0.8	■	270	0.20	1.7	✓	160	0.18	1.7	—	—	—	—	—	—	—	—	—	—	—	—	—	—
TNMG 160412E-FM-T8430	● 1.2	■	185	0.25	1.7	✓	100	0.23	1.7	✓	150	0.25	1.7	—	—	—	✓	40	0.18	1.4	—	—	—
TNMG 160412E-FM-T9325	● 1.2	■	225	0.25	1.7	✓	135	0.23	1.7	✓	210	0.25	1.7	—	—	—	✓	50	0.18	1.4	—	—	—
TNMG 160412E-FM-T9415	● 1.2	■	290	0.25	1.7	—	—	—	—	✓	275	0.25	1.7	—	—	—	—	—	—	—	—	—	—
TNMG 220404E-FM-T8430	● 0.4	■	165	0.20	1.7	✓	90	0.18	1.7	✓	135	0.20	1.7	—	—	—	✓	35	0.18	1.4	—	—	—
TNMG 220404E-FM-T9325	● 0.4	■	200	0.20	1.7	✓	120	0.18	1.7	✓	190	0.20	1.7	—	—	—	✓	45	0.18	1.4	—	—	—
TNMG 220404E-FM-T9415	● 0.4	■	250	0.20	1.7	—	—	—	—	✓	235	0.20	1.7	—	—	—	—	—	—	—	—	—	—
TNMG 220408E-FM-T8430	● 0.8	■	195	0.20	1.7	✓	105	0.18	1.7	✓	160	0.20	1.7	—	—	—	✓	40	0.16	1.4	—	—	—
TNMG 220408E-FM-T9325	● 0.8	■	235	0.20	1.7	✓	140	0.18	1.7	✓	220	0.20	1.7	—	—	—	✓	50	0.16	1.4	—	—	—
TNMG 220408E-FM-T9415	● 0.8	■	300	0.20	1.7	—	—	—	—	✓	285	0.20	1.7	—	—	—	—	—	—	—	—	—	—

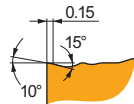

FM chip breaker is versatile and the first choice for finishing of Steels and Cast irons. It features slightly positive rake angle and positive, narrow T-land. It's also conditionally suitable for Stainless steels and Super-alloys.

VNMG 160404E-FM-T7325	● 0.4	✓	140	0.20	1.2	✓	105	0.18	1.2	—	—	—	—	—	—	✓	45	0.20	1.0	—	—	—	
VNMG 160404E-FM-T8430	● 0.4	■	135	0.20	1.2	✓	75	0.18	1.2	✓	110	0.20	1.2	—	—	—	✓	25	0.14	1.0	—	—	—
VNMG 160404E-FM-T9315	● 0.4	■	190	0.20	1.2	—	—	—	—	✓	180	0.20	1.2	—	—	—	—	—	—	—	—	—	—
VNMG 160404E-FM-T9325	● 0.4	■	170	0.20	1.2	✓	100	0.18	1.2	✓	160	0.20	1.2	—	—	—	✓	35	0.20	1.0	—	—	—
VNMG 160404E-FM-T9415	● 0.4	■	215	0.20	1.2	—	—	—	—	✓	200	0.20	1.2	—	—	—	—	—	—	—	—	—	—
VNMG 160408E-FM-T7325	● 0.8	✓	160	0.20	1.4	✓	120	0.18	1.4	—	—	—	—	—	—	✓	50	0.16	1.1	—	—	—	
VNMG 160408E-FM-T8430	● 0.8	■	165	0.20	1.4	✓	90	0.18	1.4	✓	135	0.20	1.4	—	—	—	✓	35	0.16	1.1	—	—	—
VNMG 160408E-FM-T9315	● 0.8	■	220	0.20	1.4	—	—	—	—	✓	205	0.20	1.4	—	—	—	—	—	—	—	—	—	—
VNMG 160408E-FM-T9325	● 0.8	■	200	0.20	1.4	✓	120	0.18	1.4	✓	190	0.20	1.4	—	—	—	✓	45	0.16	1.1	—	—	—
VNMG 160408E-FM-T9415	● 0.8	■	255	0.20	1.4	—	—	—	—	✓	240	0.20	1.4	—	—	—	—	—	—	—	—	—	—
VNMG 160412E-FM-T8430	● 1.2	■	165	0.22	1.4	✓	90	0.20	1.4	✓	135	0.22	1.4	—	—	—	✓	35	0.18	1.1	—	—	—
VNMG 160412E-FM-T9315	● 1.2	■	225	0.22	1.4	—	—	—	—	✓	210	0.22	1.4	—	—	—	—	—	—	—	—	—	—
VNMG 160412E-FM-T9325	● 1.2	■	200	0.22	1.4	✓	120	0.20	1.4	✓	190	0.22	1.4	—	—	—	✓	45	0.18	1.1	—	—	—
VNMG 160412E-FM-T9415	● 1.2	■	255	0.22	1.4	—	—	—	—	✓	240	0.22	1.4	—	—	—	—	—	—	—	—	—	—

Suitability and starting values for cutting speed (vc), feed (f) and depth of cut (ap). Refer to our Machining Calculator app for further calculations.

Product	RE (mm)	P			M			K			N			S			H		
		vc (m/min)	f (mm/rev)	ap (mm)	vc (m/min)	f (mm/rev)	ap (mm)	vc (m/min)	f (mm/rev)	ap (mm)	vc (m/min)	f (mm/rev)	ap (mm)	vc (m/min)	f (mm/rev)	ap (mm)	vc (m/min)	f (mm/rev)	ap (mm)

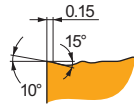
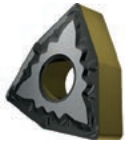

FM chip breaker is versatile and the first choice for finishing of Steels and Cast irons. It features slightly positive rake angle and positive, narrow T-land. It's also conditionally suitable for Stainless steels and Super-alloys.

WNMG 060404E-FM-T7325	● 0.4	195	0.20	1.4	150	0.18	1.4	—	—	—	—	—	—	60	0.16	1.1	—	—	—
WNMG 060404E-FM-T8315	● 0.4	180	0.20	1.4	105	0.18	1.4	170	0.20	1.4	—	—	—	45	0.14	1.1	—	—	—
WNMG 060404E-FM-T8415	● 0.4	220	0.20	1.4	115	0.18	1.4	200	0.20	1.4	—	—	—	50	0.14	1.1	—	—	—
WNMG 060404E-FM-T8430	● 0.4	195	0.20	1.4	105	0.18	1.4	160	0.20	1.4	—	—	—	40	0.14	1.1	—	—	—
WNMG 060404E-FM-T9325	● 0.4	240	0.20	1.4	140	0.18	1.4	225	0.20	1.4	—	—	—	50	0.16	1.1	—	—	—
WNMG 060404E-FM-T9415	● 0.4	305	0.20	1.4	—	—	—	285	0.20	1.4	—	—	—	—	—	—	—	—	—
WNMG 060404E-FM-TT310	● 0.4	275	0.20	1.4	165	0.18	1.4	—	—	—	—	—	—	—	—	—	—	—	—
WNMG 060408E-FM-T7325	● 0.8	235	0.20	1.4	180	0.18	1.4	—	—	—	—	—	—	75	0.16	1.1	—	—	—
WNMG 060408E-FM-T8430	● 0.8	235	0.20	1.4	125	0.18	1.4	190	0.20	1.4	—	—	—	50	0.14	1.1	—	—	—
WNMG 060408E-FM-T9315	● 0.8	315	0.20	1.4	—	—	—	295	0.20	1.4	—	—	—	—	—	—	—	—	—
WNMG 060408E-FM-T9325	● 0.8	285	0.20	1.4	170	0.18	1.4	270	0.20	1.4	—	—	—	60	0.16	1.1	—	—	—
WNMG 060408E-FM-T9415	● 0.8	365	0.20	1.4	—	—	—	345	0.20	1.4	—	—	—	—	—	—	—	—	—
WNMG 060412E-FM-T9415	● 1.2	350	0.27	1.2	—	—	—	330	0.27	1.2	—	—	—	—	—	—	—	—	—
WNMG 06T304E-FM-T8430	● 0.4	195	0.20	1.4	105	0.18	1.4	160	0.20	1.4	—	—	—	40	0.14	1.1	—	—	—
WNMG 06T304E-FM-T9325	● 0.4	240	0.20	1.4	140	0.18	1.4	225	0.20	1.4	—	—	—	50	0.16	1.1	—	—	—
WNMG 06T308E-FM-T8430	● 0.8	235	0.20	1.4	125	0.18	1.4	190	0.20	1.4	—	—	—	50	0.14	1.1	—	—	—
WNMG 06T308E-FM-T9325	● 0.8	285	0.20	1.4	170	0.18	1.4	270	0.20	1.4	—	—	—	60	0.16	1.1	—	—	—
WNMG 080404E-FM-T7325	● 0.4	190	0.20	1.9	145	0.18	1.9	—	—	—	—	—	—	60	0.16	1.5	—	—	—
WNMG 080404E-FM-T7335	● 0.4	180	0.20	1.9	140	0.18	1.9	—	—	—	—	—	—	55	0.16	1.5	—	—	—
WNMG 080404E-FM-T8315	● 0.4	180	0.20	1.9	105	0.18	1.9	170	0.20	1.9	—	—	—	45	0.14	1.5	—	—	—
WNMG 080404E-FM-T8415	● 0.4	215	0.20	1.9	110	0.18	1.9	195	0.20	1.9	—	—	—	45	0.14	1.5	—	—	—
WNMG 080404E-FM-T8430	● 0.4	190	0.20	1.9	105	0.18	1.9	155	0.20	1.9	—	—	—	40	0.14	1.5	—	—	—
WNMG 080404E-FM-T9325	● 0.4	245	0.20	1.2	145	0.18	1.2	230	0.20	1.2	—	—	—	55	0.16	1.0	—	—	—
WNMG 080404E-FM-T9415	● 0.4	310	0.20	1.2	—	—	—	290	0.20	1.2	—	—	—	—	—	—	—	—	—
WNMG 080408E-FM-T7325	● 0.8	225	0.20	1.9	175	0.18	1.9	—	—	—	—	—	—	70	0.16	1.5	—	—	—
WNMG 080408E-FM-T7335	● 0.8	215	0.20	1.9	165	0.18	1.9	—	—	—	—	—	—	65	0.16	1.5	—	—	—
WNMG 080408E-FM-T8315	● 0.8	210	0.20	1.9	125	0.18	1.9	195	0.20	1.9	—	—	—	50	0.16	1.5	—	—	—
WNMG 080408E-FM-T8415	● 0.8	250	0.20	1.9	130	0.18	1.9	225	0.20	1.9	—	—	—	55	0.16	1.5	—	—	—
WNMG 080408E-FM-T8430	● 0.8	225	0.20	1.9	120	0.18	1.9	185	0.20	1.9	—	—	—	45	0.16	1.5	—	—	—
WNMG 080408E-FM-T9325	● 0.8	280	0.20	1.9	165	0.18	1.9	265	0.20	1.9	—	—	—	60	0.16	1.5	—	—	—
WNMG 080408E-FM-T9415	● 0.8	350	0.20	1.9	—	—	—	330	0.20	1.9	—	—	—	—	—	—	—	—	—
WNMG 080412E-FM-T7325	● 1.2	220	0.27	1.9	170	0.24	1.9	—	—	—	—	—	—	70	0.19	1.5	—	—	—
WNMG 080412E-FM-T7335	● 1.2	205	0.27	1.9	155	0.24	1.9	—	—	—	—	—	—	65	0.19	1.5	—	—	—
WNMG 080412E-FM-T8430	● 1.2	210	0.27	1.9	115	0.24	1.9	175	0.27	1.9	—	—	—	45	0.19	1.5	—	—	—
WNMG 080412E-FM-T9310	● 1.2	310	0.27	1.9	—	—	—	290	0.27	1.9	—	—	—	—	—	—	—	—	—
WNMG 080412E-FM-T9325	● 1.2	255	0.27	1.9	150	0.24	1.9	240	0.27	1.9	—	—	—	55	0.19	1.5	—	—	—
WNMG 080412E-FM-T9415	● 1.2	335	0.27	1.9	—	—	—	315	0.27	1.9	—	—	—	—	—	—	—	—	—

SF

SF chip breaker is sharp and the first choice for finishing of Stainless steels and Super-alloys. It features slightly positive rake angle without T-land. It's also suitable for Steels, Cast irons and Hard materials, and conditionally for Non-ferrous alloys.

PRAMET

CNGG / CNMG

	IC	D1	L	S
	(mm)	(mm)	(mm)	(mm)
1204	12.700	5.16	12.90	4.76

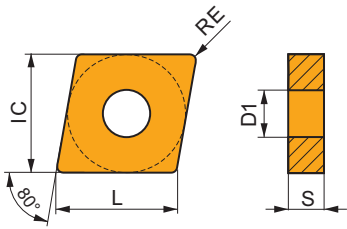

DNMG

	IC	D1	L	S
	(mm)	(mm)	(mm)	(mm)
1104	9.525	3.81	11.60	4.76
1504	12.700	5.16	15.50	4.76
1506	12.700	5.16	15.50	6.35

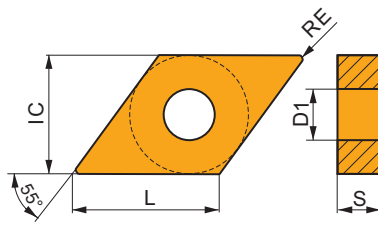

SNMG

	IC	D1	L	S
	(mm)	(mm)	(mm)	(mm)
1204	12.700	5.16	12.70	4.76

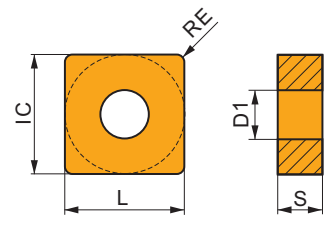

TNMG

	IC	D1	L	S
	(mm)	(mm)	(mm)	(mm)
1604	9.525	3.81	16.50	4.76
2204	12.700	5.16	22.00	4.76

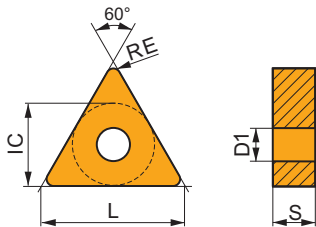

VNMG

	IC	D1	L	S
	(mm)	(mm)	(mm)	(mm)
1604	9.525	3.81	16.60	4.76

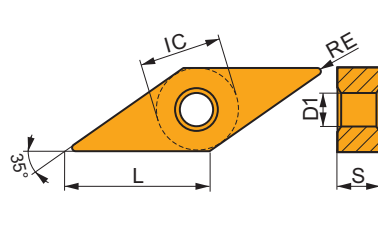

WNMG

	IC	D1	L	S
	(mm)	(mm)	(mm)	(mm)
0604	9.525	3.81	6.50	4.76
0804	12.700	5.16	8.70	4.76

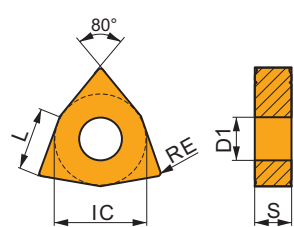

Suitability and starting values for cutting speed (vc), feed (f) and depth of cut (ap). Refer to our Machining Calculator app for further calculations.

Product	RE (mm)	P			M			K			N			S			H		
		vc (m/min)	f (mm/rev)	ap (mm)	vc (m/min)	f (mm/rev)	ap (mm)	vc (m/min)	f (mm/rev)	ap (mm)	vc (m/min)	f (mm/rev)	ap (mm)	vc (m/min)	f (mm/rev)	ap (mm)	vc (m/min)	f (mm/rev)	ap (mm)

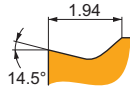
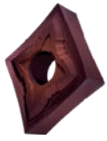

SF chip breaker is sharp and the first choice for finishing of Stainless steels and Super-alloys. It features slightly positive rake angle without T-land. It's also suitable for Steels, Cast irons and Hard materials, and conditionally for Non-ferrous alloys.

CNGG 120402E-SF:H07	● 0.2	–	–	–	105	0.09	1.0	165	0.10	1.0	525	0.12	1.0	50	0.08	0.8	–	–	–		
CNGG 120402E-SF:T6310	● 0.2	■	195	0.10	1.0	■	140	0.09	1.0	■	155	0.10	1.0	■	55	0.08	0.8	■	35	0.10	0.2
CNGG 120402E-SF:T8315	● 0.2	■	205	0.10	1.0	■	120	0.09	1.0	■	190	0.10	1.0	■	50	0.08	0.8	■	40	0.10	0.2
CNGG 120402E-SF:T8415	● 0.2	■	250	0.10	1.0	■	130	0.09	1.0	■	225	0.10	1.0	■	55	0.08	0.8	■	40	0.10	0.2
CNGG 120402E-SF:T8430	● 0.2	■	240	0.10	1.0	■	130	0.09	1.0	■	195	0.10	1.0	■	50	0.08	0.8	■	40	0.10	0.2

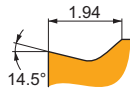

SF chip breaker is sharp and the first choice for finishing of Stainless steels and Super-alloys. It features slightly positive rake angle without T-land. It's also suitable for Steels, Cast irons and Hard materials, and conditionally for Non-ferrous alloys.

CNMG 120404E-SF:H07	● 0.4	–	–	–	90	0.14	1.0	145	0.15	1.0	470	0.18	1.0	45	0.12	0.8	–	–	–				
CNMG 120404E-SF:T6310	● 0.4	■	180	0.15	1.0	■	125	0.14	1.0	■	145	0.15	1.0	■	50	0.12	0.8	■	35	0.11	0.3		
CNMG 120404E-SF:T7325	● 0.4	■	205	0.17	1.0	■	155	0.15	1.0	–	–	–	–	65	0.15	0.8	–	–	–				
CNMG 120404E-SF:T8315	● 0.4	■	195	0.15	1.0	■	115	0.14	1.0	■	185	0.15	1.0	■	45	0.12	0.8	■	35	0.11	0.3		
CNMG 120404E-SF:T8415	● 0.4	■	240	0.15	1.0	■	125	0.14	1.0	■	215	0.15	1.0	■	55	0.12	0.8	■	40	0.10	0.3		
CNMG 120404E-SF:T8430	● 0.4	■	220	0.15	1.0	■	120	0.14	1.0	■	180	0.15	1.0	■	45	0.12	0.8	■	35	0.11	0.3		
CNMG 120404E-SF:T9325	● 0.4	■	255	0.17	1.0	■	150	0.15	1.0	■	240	0.17	1.0	–	–	–	■	55	0.15	0.8			
CNMG 120404E-SF:T9415	● 0.4	■	315	0.17	1.0	–	–	–	–	■	295	0.17	1.0	–	–	–	–	–	–	■	60	0.13	0.3
CNMG 120408E-SF:H07	● 0.8	–	–	–	95	0.18	1.0	155	0.20	1.0	495	0.24	1.0	50	0.15	0.8	–	–	–				
CNMG 120408E-SF:T6310	● 0.8	■	200	0.20	1.0	■	140	0.18	1.0	■	160	0.20	1.0	■	60	0.14	0.8	■	40	0.10	0.7		
CNMG 120408E-SF:T7325	● 0.8	■	230	0.20	1.0	■	175	0.18	1.0	–	–	–	–	70	0.16	0.8	–	–	–				
CNMG 120408E-SF:T7335	● 0.8	■	220	0.20	1.0	■	170	0.18	1.0	–	–	–	–	70	0.16	0.8	–	–	–				
CNMG 120408E-SF:T8315	● 0.8	■	210	0.20	1.0	■	125	0.18	1.0	■	195	0.20	1.0	■	50	0.14	0.8	■	40	0.10	0.7		
CNMG 120408E-SF:T8415	● 0.8	■	255	0.20	1.0	■	135	0.18	1.0	■	230	0.20	1.0	■	55	0.14	0.8	■	45	0.10	0.7		
CNMG 120408E-SF:T8430	● 0.8	■	230	0.20	1.0	■	125	0.18	1.0	■	185	0.20	1.0	■	45	0.14	0.8	■	35	0.10	0.7		
CNMG 120408E-SF:T9325	● 0.8	■	280	0.20	1.0	■	165	0.18	1.0	■	265	0.20	1.0	–	–	–	■	60	0.16	0.8			
CNMG 120412E-SF:T6310	● 1.2	■	190	0.25	1.5	■	135	0.23	1.5	■	150	0.25	1.5	■	55	0.18	1.2	■	35	0.13	1.0		
CNMG 120412E-SF:T8315	● 1.2	■	200	0.25	1.5	■	120	0.23	1.5	■	190	0.25	1.5	■	50	0.18	1.2	■	40	0.13	1.0		
CNMG 120412E-SF:T8415	● 1.2	■	250	0.25	1.5	■	130	0.23	1.5	■	225	0.25	1.5	■	55	0.17	1.2	■	40	0.13	1.0		
CNMG 120412E-SF:T8430	● 1.2	■	210	0.25	1.5	■	115	0.23	1.5	■	175	0.25	1.5	■	45	0.18	1.2	■	35	0.13	1.0		

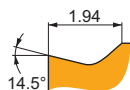

SF chip breaker is sharp and the first choice for finishing of Stainless steels and Super-alloys. It features slightly positive rake angle without T-land. It's also suitable for Steels, Cast irons and Hard materials, and conditionally for Non-ferrous alloys.

DNMG 110404E-SF:T6310	● 0.4	■	150	0.15	0.8	■	105	0.14	0.8	■	120	0.15	0.8	■	45	0.12	0.6	■	30	0.11	0.3
DNMG 110404E-SF:T8315	● 0.4	■	160	0.15	0.8	■	95	0.14	0.8	■	150	0.15	0.8	■	40	0.12	0.6	■	30	0.11	0.3
DNMG 110404E-SF:T8415	● 0.4	■	190	0.15	0.8	■	100	0.14	0.8	■	170	0.15	0.8	■	40	0.12	0.6	■	30	0.10	0.3
DNMG 110404E-SF:T8430	● 0.4	■	180	0.15	0.8	■	95	0.14	0.8	■	145	0.15	0.8	■	35	0.12	0.6	■	30	0.11	0.3
DNMG 110408E-SF:T6310	● 0.8	■	175	0.17	0.8	■	125	0.15	0.8	■	140	0.17	0.8	■	50	0.14	0.6	■	35	0.11	0.7
DNMG 110408E-SF:T8415	● 0.8	■	220	0.17	0.8	■	115	0.15	0.8	■	200	0.17	0.8	■	50	0.14	0.6	■	35	0.11	0.7
DNMG 110408E-SF:T8430	● 0.8	■	200	0.17	0.8	■	110	0.15	0.8	■	165	0.17	0.8	■	40	0.14	0.6	■	35	0.11	0.7
DNMG 150404E-SF:T6310	● 0.4	■	140	0.15	1.5	■	100	0.14	1.5	■	110	0.15	1.5	■	40	0.12	1.2	■	25	0.11	0.3
DNMG 150404E-SF:T8315	● 0.4	■	150	0.15	1.5	■	90	0.14	1.5	■	140	0.15	1.5	■	35	0.12	1.2	■	30	0.11	0.3
DNMG 150404E-SF:T8415	● 0.4	■	180	0.15	1.5	■	90	0.14	1.5	■	160	0.15	1.5	■	40	0.12	1.2	■	30	0.10	0.3
DNMG 150404E-SF:T8430	● 0.4	■	165	0.15	1.5	■	90	0.14	1.5	■	135	0.15	1.5	■	35	0.12	1.2	■	25	0.11	0.3
DNMG 150408E-SF:T6310	● 0.8	■	160	0.17	1.5	■	115	0.15	1.5	■	125	0.17	1.5	■	45	0.14	1.2	■	30	0.11	0.7
DNMG 150408E-SF:T8315	● 0.8	■	170	0.17	1.5	■	100	0.15	1.5	■	160	0.17	1.5	■	40	0.14	1.2	■	30	0.11	0.7
DNMG 150408E-SF:T8415	● 0.8	■	210	0.17	1.5	■	110	0.15	1.5	■	190	0.17	1.5	■	45	0.14	1.2	■	35	0.11	0.7
DNMG 150408E-SF:T8430	● 0.8	■	190	0.17	1.5	■	105	0.15	1.5	■	155	0.17	1.5	■	40	0.14	1.2	■	30	0.11	0.7
DNMG 150604E-SF:H07	● 0.4	–	–	–	70	0.14	1.5	115	0.15	1.5	360	0.18	1.5	35	0.12	1.2	–	–	–		
DNMG 150604E-SF:T6310	● 0.4	■	140	0.15	1.5	■	100	0.14	1.5	■	110	0.15	1.5	■	40	0.12	1.2	■	25	0.11	0.3
DNMG 150604E-SF:T7325	● 0.4	■	155	0.17	1.5	■	120	0.15	1.5	–	–	–	–	50	0.15	1.2	–	–	–		
DNMG 150604E-SF:T8315	● 0.4	■	150	0.15	1.5	■	90	0.14	1.5	■	140	0.15	1.5	■	35	0.12	1.2	■	30	0.11	0.3
DNMG 150604E-SF:T8415	● 0.4	■	180	0.15	1.5	■	90	0.14	1.5	■	160	0.15	1.5	■	40	0.12	1.2	■	30	0.10	0.3
DNMG 150604E-SF:T8430	● 0.4	■	165	0.15	1.5	■	90	0.14	1.5	■	135	0.15	1.5	■	35	0.12	1.2	■	25	0.11	0.3

Suitability and starting values for cutting speed (vc), feed (f) and depth of cut (ap). Refer to our Machining Calculator app for further calculations.

Product	RE (mm)	P			M			K			N			S			H		
		vc (m/min)	f (mm/rev)	ap (mm)	vc (m/min)	f (mm/rev)	ap (mm)	vc (m/min)	f (mm/rev)	ap (mm)	vc (m/min)	f (mm/rev)	ap (mm)	vc (m/min)	f (mm/rev)	ap (mm)	vc (m/min)	f (mm/rev)	ap (mm)

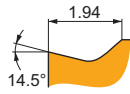

SF chip breaker is sharp and the first choice for finishing of Stainless steels and Super-alloys. It features slightly positive rake angle without T-land. It's also suitable for Steels, Cast irons and Hard materials, and conditionally for Non-ferrous alloys.

DNMG 150608E-SF:H07	● 0.8	–	–	–	80	0.15	1.5	130	0.17	1.5	415	0.20	1.5	40	0.14	1.2	–	–	–
DNMG 150608E-SF:T6310	● 0.8	160	0.17	1.5	115	0.15	1.5	125	0.17	1.5	480	0.20	1.5	45	0.14	1.2	30	0.11	0.7
DNMG 150608E-SF:T7325	● 0.8	185	0.17	1.5	140	0.15	1.5	–	–	–	–	–	–	60	0.15	1.2	–	–	–
DNMG 150608E-SF:T8315	● 0.8	170	0.17	1.5	100	0.15	1.5	160	0.17	1.5	510	0.20	1.5	40	0.14	1.2	30	0.11	0.7
DNMG 150608E-SF:T8415	● 0.8	210	0.17	1.5	110	0.15	1.5	190	0.17	1.5	525	0.20	1.5	45	0.14	1.2	35	0.11	0.7
DNMG 150608E-SF:T8430	● 0.8	190	0.17	1.5	105	0.15	1.5	155	0.17	1.5	525	0.20	1.5	40	0.14	1.2	30	0.11	0.7
DNMG 150608E-SF:T9325	● 0.8	235	0.17	1.5	140	0.15	1.5	220	0.17	1.5	–	–	–	50	0.15	1.2	–	–	–
DNMG 150608E-SF:T9415	● 0.8	290	0.17	1.5	–	–	–	275	0.17	1.5	–	–	–	–	–	–	55	0.12	0.7
DNMG 150612E-SF:T6310	● 1.2	155	0.25	1.5	110	0.23	1.5	125	0.25	1.5	465	0.30	1.5	45	0.18	1.2	30	0.13	0.9
DNMG 150612E-SF:T8415	● 1.2	195	0.25	1.5	100	0.23	1.5	180	0.25	1.5	495	0.30	1.5	45	0.17	1.2	30	0.13	0.9

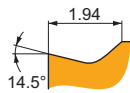
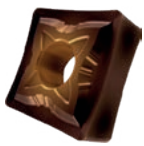

SF chip breaker is sharp and the first choice for finishing of Stainless steels and Super-alloys. It features slightly positive rake angle without T-land. It's also suitable for Steels, Cast irons and Hard materials, and conditionally for Non-ferrous alloys.

SNMG 120408E-SF:H07	● 0.8	–	–	–	105	0.18	1.0	165	0.20	1.0	525	0.24	1.0	50	0.14	0.8	–	–	–
SNMG 120408E-SF:T6310	● 0.8	210	0.20	1.0	150	0.18	1.0	165	0.20	1.0	630	0.24	1.0	60	0.14	0.8	40	0.10	0.7
SNMG 120408E-SF:T8415	● 0.8	275	0.20	1.0	140	0.18	1.0	250	0.20	1.0	690	0.24	1.0	60	0.14	0.8	45	0.10	0.7
SNMG 120408E-SF:T8430	● 0.8	245	0.20	1.0	135	0.18	1.0	200	0.20	1.0	675	0.24	1.0	50	0.14	0.8	40	0.10	0.7
SNMG 120408E-SF:T9325	● 0.8	295	0.20	1.0	175	0.18	1.0	280	0.20	1.0	–	–	–	65	0.16	0.8	–	–	–
SNMG 120412E-SF:T6310	● 1.2	200	0.25	1.5	140	0.23	1.5	160	0.25	1.5	600	0.30	1.5	60	0.18	1.2	40	0.13	1.0
SNMG 120412E-SF:T8415	● 1.2	260	0.25	1.5	135	0.23	1.5	240	0.25	1.5	660	0.30	1.5	60	0.17	1.2	45	0.13	1.0
SNMG 120412E-SF:T8430	● 1.2	225	0.25	1.5	120	0.23	1.5	185	0.25	1.5	615	0.30	1.5	45	0.18	1.2	35	0.13	1.0

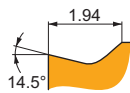
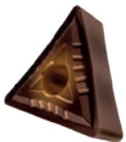

SF chip breaker is sharp and the first choice for finishing of Stainless steels and Super-alloys. It features slightly positive rake angle without T-land. It's also suitable for Steels, Cast irons and Hard materials, and conditionally for Non-ferrous alloys.

TNMG 160404E-SF:T6310	● 0.4	150	0.15	1.3	105	0.14	1.3	120	0.15	1.3	450	0.18	1.3	45	0.12	1.0	30	0.11	0.3
TNMG 160404E-SF:T7325	● 0.4	170	0.17	1.3	130	0.15	1.3	–	–	–	–	–	–	55	0.15	1.0	–	–	–
TNMG 160404E-SF:T8315	● 0.4	160	0.15	1.3	95	0.14	1.3	150	0.15	1.3	480	0.18	1.3	40	0.12	1.0	30	0.11	0.3
TNMG 160404E-SF:T8415	● 0.4	195	0.15	1.3	100	0.14	1.3	180	0.15	1.3	495	0.18	1.3	45	0.12	1.0	30	0.10	0.3
TNMG 160404E-SF:T8430	● 0.4	180	0.15	1.3	95	0.14	1.3	145	0.15	1.3	495	0.18	1.3	35	0.12	1.0	30	0.11	0.3
TNMG 160408E-SF:T6310	● 0.8	175	0.17	1.3	125	0.15	1.3	140	0.17	1.3	525	0.20	1.3	50	0.14	1.0	35	0.11	0.7
TNMG 160408E-SF:T8315	● 0.8	185	0.17	1.3	110	0.15	1.3	175	0.17	1.3	555	0.20	1.3	45	0.14	1.0	35	0.11	0.7
TNMG 160408E-SF:T8415	● 0.8	225	0.17	1.3	115	0.15	1.3	205	0.17	1.3	570	0.20	1.3	50	0.14	1.0	35	0.11	0.7
TNMG 160408E-SF:T8430	● 0.8	205	0.17	1.3	110	0.15	1.3	170	0.17	1.3	570	0.20	1.3	45	0.14	1.0	35	0.11	0.7
TNMG 160412E-SF:T6310	● 1.2	165	0.25	1.5	115	0.23	1.5	130	0.25	1.5	495	0.30	1.5	45	0.18	1.2	30	0.13	0.9
TNMG 160412E-SF:T8415	● 1.2	210	0.25	1.5	110	0.23	1.5	190	0.25	1.5	525	0.30	1.5	45	0.17	1.2	35	0.13	0.9
TNMG 220404E-SF:T6310	● 0.4	145	0.17	1.7	100	0.15	1.7	115	0.17	1.7	435	0.20	1.7	40	0.15	1.4	25	0.12	0.3
TNMG 220404E-SF:T8415	● 0.4	185	0.17	1.7	95	0.15	1.7	165	0.17	1.7	465	0.20	1.7	40	0.15	1.4	30	0.12	0.3
TNMG 220408E-SF:T6310	● 0.8	170	0.17	1.7	120	0.15	1.7	135	0.17	1.7	510	0.20	1.7	50	0.15	1.4	30	0.12	0.7
TNMG 220408E-SF:T8315	● 0.8	180	0.17	1.7	105	0.15	1.7	170	0.17	1.7	540	0.20	1.7	45	0.15	1.4	35	0.12	0.7
TNMG 220408E-SF:T8415	● 0.8	220	0.17	1.7	115	0.15	1.7	200	0.17	1.7	555	0.20	1.7	50	0.15	1.4	35	0.12	0.7
TNMG 220408E-SF:T8430	● 0.8	195	0.17	1.7	105	0.15	1.7	160	0.17	1.7	540	0.20	1.7	40	0.15	1.4	30	0.12	0.7
TNMG 220412E-SF:T6310	● 1.2	155	0.30	1.7	110	0.27	1.7	125	0.30	1.7	465	0.36	1.7	45	0.21	1.4	30	0.15	0.9
TNMG 220412E-SF:T8415	● 1.2	195	0.30	1.7	100	0.27	1.7	180	0.30	1.7	495	0.36	1.7	45	0.21	1.4	30	0.15	0.9

Suitability and starting values for cutting speed (vc), feed (f) and depth of cut (ap). Refer to our Machining Calculator app for further calculations.

Product	RE (mm)	P			M			K			N			S			H		
		vc (m/min)	f (mm/rev)	ap (mm)	vc (m/min)	f (mm/rev)	ap (mm)	vc (m/min)	f (mm/rev)	ap (mm)	vc (m/min)	f (mm/rev)	ap (mm)	vc (m/min)	f (mm/rev)	ap (mm)	vc (m/min)	f (mm/rev)	ap (mm)

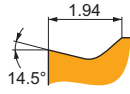

SF chip breaker is sharp and the first choice for finishing of Stainless steels and Super-alloys. It features slightly positive rake angle without T-land. It's also suitable for Steels, Cast irons and Hard materials, and conditionally for Non-ferrous alloys.

VNMG 160404E-SF:T6310	● 0.4	■ 125	■ 0.15	■ 1.2	■ 90	■ 0.14	■ 1.2	■ 100	■ 0.15	■ 1.2	■ 375	■ 0.18	■ 1.2	■ 35	■ 0.14	■ 1.0	■ 25	■ 0.15	■ 0.3
VNMG 160404E-SF:T7325	● 0.4	■ 145	■ 0.15	■ 1.2	■ 110	■ 0.14	■ 1.2	—	—	—	—	—	—	■ 45	■ 0.14	■ 1.0	—	—	—
VNMG 160404E-SF:T8315	● 0.4	■ 135	■ 0.15	■ 1.2	■ 80	■ 0.14	■ 1.2	■ 125	■ 0.15	■ 1.2	■ 405	■ 0.18	■ 1.2	■ 30	■ 0.14	■ 1.0	■ 25	■ 0.15	■ 0.3
VNMG 160404E-SF:T8415	● 0.4	■ 160	■ 0.15	■ 1.2	■ 85	■ 0.14	■ 1.2	■ 145	■ 0.15	■ 1.2	■ 405	■ 0.18	■ 1.2	■ 35	■ 0.14	■ 1.0	■ 25	■ 0.15	■ 0.3
VNMG 160404E-SF:T8430	● 0.4	■ 145	■ 0.15	■ 1.2	■ 80	■ 0.14	■ 1.2	■ 120	■ 0.15	■ 1.2	■ 405	■ 0.18	■ 1.2	■ 30	■ 0.14	■ 1.0	■ 25	■ 0.15	■ 0.3
VNMG 160408E-SF:T6310	● 0.8	■ 140	■ 0.17	■ 1.4	■ 100	■ 0.15	■ 1.4	■ 110	■ 0.17	■ 1.4	■ 420	■ 0.20	■ 1.4	■ 40	■ 0.14	■ 1.1	■ 25	■ 0.11	■ 0.7
VNMG 160408E-SF:T8315	● 0.8	■ 150	■ 0.17	■ 1.4	■ 90	■ 0.15	■ 1.4	■ 140	■ 0.17	■ 1.4	■ 450	■ 0.20	■ 1.4	■ 35	■ 0.14	■ 1.1	■ 30	■ 0.11	■ 0.7
VNMG 160408E-SF:T8415	● 0.8	■ 185	■ 0.17	■ 1.4	■ 95	■ 0.15	■ 1.4	■ 165	■ 0.17	■ 1.4	■ 465	■ 0.20	■ 1.4	■ 40	■ 0.14	■ 1.1	■ 30	■ 0.11	■ 0.7
VNMG 160408E-SF:T8430	● 0.8	■ 165	■ 0.17	■ 1.4	■ 90	■ 0.15	■ 1.4	■ 135	■ 0.17	■ 1.4	■ 450	■ 0.20	■ 1.4	■ 35	■ 0.14	■ 1.1	■ 25	■ 0.11	■ 0.7
VNMG 160408E-SF:T9325	● 0.8	■ 205	■ 0.17	■ 1.4	■ 120	■ 0.15	■ 1.4	■ 190	■ 0.17	■ 1.4	—	—	—	■ 45	■ 0.15	■ 1.1	—	—	—
VNMG 160408E-SF:T9415	● 0.8	■ 255	■ 0.17	■ 1.4	—	—	—	■ 240	■ 0.17	■ 1.4	—	—	—	—	—	—	■ 50	■ 0.12	■ 0.7

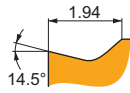
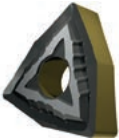

SF chip breaker is sharp and the first choice for finishing of Stainless steels and Super-alloys. It features slightly positive rake angle without T-land. It's also suitable for Steels, Cast irons and Hard materials, and conditionally for Non-ferrous alloys.

WNMG 060404E-SF:T6310	● 0.4	■ 180	■ 0.15	■ 1.0	■ 125	■ 0.14	■ 1.0	■ 145	■ 0.15	■ 1.0	■ 540	■ 0.18	■ 1.0	■ 50	■ 0.12	■ 0.8	■ 35	■ 0.11	■ 0.3
WNMG 060404E-SF:T8315	● 0.4	■ 195	■ 0.15	■ 1.0	■ 115	■ 0.14	■ 1.0	■ 185	■ 0.15	■ 1.0	■ 585	■ 0.18	■ 1.0	■ 45	■ 0.12	■ 0.8	■ 35	■ 0.11	■ 0.3
WNMG 060404E-SF:T8415	● 0.4	■ 240	■ 0.15	■ 1.0	■ 125	■ 0.14	■ 1.0	■ 215	■ 0.15	■ 1.0	■ 600	■ 0.18	■ 1.0	■ 55	■ 0.12	■ 0.8	■ 40	■ 0.10	■ 0.3
WNMG 060404E-SF:T8430	● 0.4	■ 220	■ 0.15	■ 1.0	■ 120	■ 0.14	■ 1.0	■ 180	■ 0.15	■ 1.0	■ 600	■ 0.18	■ 1.0	■ 45	■ 0.12	■ 0.8	■ 35	■ 0.11	■ 0.3
WNMG 060408E-SF:T6310	● 0.8	■ 200	■ 0.20	■ 1.0	■ 140	■ 0.18	■ 1.0	■ 160	■ 0.20	■ 1.0	■ 600	■ 0.24	■ 1.0	■ 60	■ 0.14	■ 0.8	■ 40	■ 0.10	■ 0.7
WNMG 060408E-SF:T8315	● 0.8	■ 210	■ 0.20	■ 1.0	■ 125	■ 0.18	■ 1.0	■ 195	■ 0.20	■ 1.0	■ 630	■ 0.24	■ 1.0	■ 50	■ 0.14	■ 0.8	■ 40	■ 0.10	■ 0.7
WNMG 060408E-SF:T8415	● 0.8	■ 255	■ 0.20	■ 1.0	■ 135	■ 0.18	■ 1.0	■ 230	■ 0.20	■ 1.0	■ 645	■ 0.24	■ 1.0	■ 55	■ 0.14	■ 0.8	■ 45	■ 0.10	■ 0.7
WNMG 060408E-SF:T8430	● 0.8	■ 230	■ 0.20	■ 1.0	■ 125	■ 0.18	■ 1.0	■ 185	■ 0.20	■ 1.0	■ 630	■ 0.24	■ 1.0	■ 45	■ 0.14	■ 0.8	■ 35	■ 0.10	■ 0.7
WNMG 080404E-SF:H07	● 0.4	—	—	—	■ 90	■ 0.14	■ 1.0	■ 145	■ 0.15	■ 1.0	■ 470	■ 0.18	■ 1.0	■ 45	■ 0.12	■ 0.8	—	—	—
WNMG 080404E-SF:T6310	● 0.4	■ 180	■ 0.15	■ 1.0	■ 125	■ 0.14	■ 1.0	■ 145	■ 0.15	■ 1.0	■ 540	■ 0.18	■ 1.0	■ 50	■ 0.12	■ 0.8	■ 35	■ 0.11	■ 0.3
WNMG 080404E-SF:T7325	● 0.4	■ 205	■ 0.17	■ 1.0	■ 155	■ 0.15	■ 1.0	—	—	—	—	—	■ 65	■ 0.15	■ 0.8	—	—	—	
WNMG 080404E-SF:T8315	● 0.4	■ 195	■ 0.15	■ 1.0	■ 115	■ 0.14	■ 1.0	■ 185	■ 0.15	■ 1.0	■ 585	■ 0.18	■ 1.0	■ 45	■ 0.12	■ 0.8	■ 35	■ 0.11	■ 0.3
WNMG 080404E-SF:T8415	● 0.4	■ 240	■ 0.15	■ 1.0	■ 125	■ 0.14	■ 1.0	■ 215	■ 0.15	■ 1.0	■ 600	■ 0.18	■ 1.0	■ 55	■ 0.12	■ 0.8	■ 40	■ 0.10	■ 0.3
WNMG 080404E-SF:T8430	● 0.4	■ 220	■ 0.15	■ 1.0	■ 120	■ 0.14	■ 1.0	■ 180	■ 0.15	■ 1.0	■ 600	■ 0.18	■ 1.0	■ 45	■ 0.12	■ 0.8	■ 35	■ 0.11	■ 0.3
WNMG 080408E-SF:H07	● 0.8	—	—	—	■ 95	■ 0.18	■ 1.0	■ 155	■ 0.20	■ 1.0	■ 495	■ 0.24	■ 1.0	■ 50	■ 0.14	■ 0.8	—	—	—
WNMG 080408E-SF:T6310	● 0.8	■ 200	■ 0.20	■ 1.0	■ 140	■ 0.18	■ 1.0	■ 160	■ 0.20	■ 1.0	■ 600	■ 0.24	■ 1.0	■ 60	■ 0.14	■ 0.8	■ 40	■ 0.10	■ 0.7
WNMG 080408E-SF:T7325	● 0.8	■ 230	■ 0.20	■ 1.0	■ 175	■ 0.18	■ 1.0	—	—	—	—	—	■ 70	■ 0.16	■ 0.8	—	—	—	
WNMG 080408E-SF:T7335	● 0.8	■ 220	■ 0.20	■ 1.0	■ 170	■ 0.18	■ 1.0	—	—	—	—	—	■ 70	■ 0.16	■ 0.8	—	—	—	
WNMG 080408E-SF:T8315	● 0.8	■ 210	■ 0.20	■ 1.0	■ 125	■ 0.18	■ 1.0	■ 195	■ 0.20	■ 1.0	■ 630	■ 0.24	■ 1.0	■ 50	■ 0.14	■ 0.8	■ 40	■ 0.10	■ 0.7
WNMG 080408E-SF:T8415	● 0.8	■ 255	■ 0.20	■ 1.0	■ 135	■ 0.18	■ 1.0	■ 230	■ 0.20	■ 1.0	■ 645	■ 0.24	■ 1.0	■ 55	■ 0.14	■ 0.8	■ 45	■ 0.10	■ 0.7
WNMG 080408E-SF:T8430	● 0.8	■ 230	■ 0.20	■ 1.0	■ 125	■ 0.18	■ 1.0	■ 185	■ 0.20	■ 1.0	■ 630	■ 0.24	■ 1.0	■ 45	■ 0.14	■ 0.8	■ 35	■ 0.10	■ 0.7
WNMG 080408E-SF:T9325	● 0.8	■ 280	■ 0.20	■ 1.0	■ 165	■ 0.18	■ 1.0	■ 265	■ 0.20	■ 1.0	—	—	—	■ 60	■ 0.16	■ 0.8	—	—	—
WNMG 080408E-SF:T9415	● 0.8	■ 355	■ 0.20	■ 1.0	—	—	—	■ 335	■ 0.20	■ 1.0	—	—	—	—	—	—	■ 70	■ 0.13	■ 0.7

W-M

W-M chip breaker has wiper edge and is designed for finishing of Steels. It features positive rake angle and positive, moderate T-land. It's also conditionally suitable for Cast irons.

PRAMET

W-MR

W-MR chip breaker has wiper edge and is designed for finishing of Steels. It features positive rake angle and stable, wide T-land. It's also conditionally suitable for Stainless steels and Cast irons.

PRAMET

CNMG

	IC	D1	L	S
	(mm)	(mm)	(mm)	(mm)
1204	12.700	5.16	12.90	4.76

DNMG

	IC	D1	L	S
	(mm)	(mm)	(mm)	(mm)
1506	12.700	5.16	15.50	6.35

WNMG

	IC	D1	L	S
	(mm)	(mm)	(mm)	(mm)
0604	9.525	3.81	6.50	4.76
0804	12.700	5.16	8.70	4.76

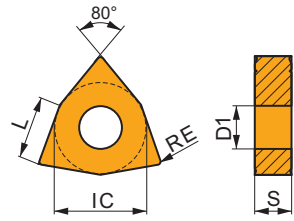
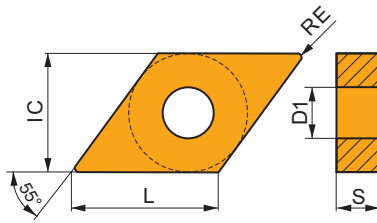
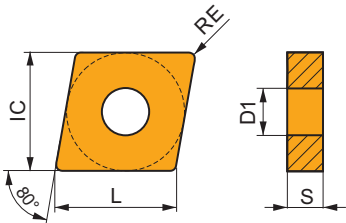

Suitability and starting values for cutting speed (vc), feed (f) and depth of cut (ap). Refer to our Machining Calculator app for further calculations.

Product	RE (mm)	P			M			K			N			S			H		
		vc (m/min)	f (mm/rev)	ap (mm)	vc (m/min)	f (mm/rev)	ap (mm)	vc (m/min)	f (mm/rev)	ap (mm)	vc (m/min)	f (mm/rev)	ap (mm)	vc (m/min)	f (mm/rev)	ap (mm)	vc (m/min)	f (mm/rev)	ap (mm)

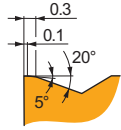
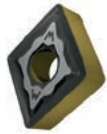

W-M chip breaker has wiper edge and is designed for finishing of Steels. It features positive rake angle and positive, moderate T-land. It's also conditionally suitable for Cast irons.

CNMG 120408W-M:T5315	0.8	230	0.45	1.5	–	–	–	215	0.45	1.5	–	–	–	–	–	–	–	–
CNMG 120408W-M:T9315	0.8	200	0.45	1.5	–	–	–	190	0.45	1.5	–	–	–	–	–	–	–	–
CNMG 120408W-M:T9325	0.8	185	0.45	1.5	–	–	–	175	0.45	1.5	–	–	–	–	–	–	–	–
CNMG 120408W-M:T9415	0.8	245	0.45	1.5	–	–	–	230	0.45	1.5	–	–	–	–	–	–	–	–

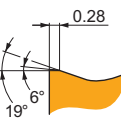
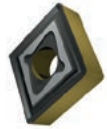

W-MR chip breaker has wiper edge and is designed for finishing of Steels. It features positive rake angle and stable, wide T-land. It's also conditionally suitable for Stainless steels and Cast irons.

CNMG 120404W-MR:T9415	0.4	240	0.30	1.5	–	–	–	225	0.30	1.5	–	–	–	–	–	–	–	–
CNMG 120408W-MR:T5315	0.8	230	0.45	1.5	–	–	–	215	0.45	1.5	–	–	–	–	–	–	–	–
CNMG 120408W-MR:T9325	0.8	185	0.45	1.5	110	0.41	1.5	175	0.45	1.5	–	–	–	–	–	–	–	–
CNMG 120408W-MR:T9415	0.8	245	0.45	1.5	–	–	–	230	0.45	1.5	–	–	–	–	–	–	–	–
CNMG 120412W-MR:T5315	1.2	230	0.55	1.5	–	–	–	215	0.55	1.5	–	–	–	–	–	–	–	–
CNMG 120412W-MR:T9315	1.2	200	0.55	1.5	–	–	–	190	0.55	1.5	–	–	–	–	–	–	–	–
CNMG 120412W-MR:T9325	1.2	180	0.55	1.5	105	0.50	1.5	170	0.55	1.5	–	–	–	–	–	–	–	–
CNMG 120412W-MR:T9415	1.2	245	0.55	1.5	–	–	–	230	0.55	1.5	–	–	–	–	–	–	–	–

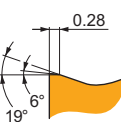
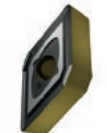

W-MR chip breaker has wiper edge and is designed for finishing of Steels. It features positive rake angle and stable, wide T-land. It's also conditionally suitable for Stainless steels and Cast irons.

DNMG 150608W-MR:T9325	0.8	155	0.40	1.5	90	0.36	1.5	145	0.40	1.5	–	–	–	–	–	–	–	–
DNMG 150608W-MR:T9415	0.8	205	0.40	1.5	–	–	–	190	0.40	1.5	–	–	–	–	–	–	–	–
DNMG 150612W-MR:T9315	1.2	160	0.50	1.5	–	–	–	150	0.50	1.5	–	–	–	–	–	–	–	–
DNMG 150612W-MR:T9325	1.2	145	0.50	1.5	85	0.45	1.5	135	0.50	1.5	–	–	–	–	–	–	–	–
DNMG 150612W-MR:T9415	1.2	200	0.50	1.5	–	–	–	190	0.50	1.5	–	–	–	–	–	–	–	–

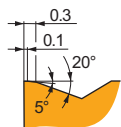
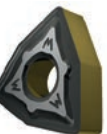

W-M chip breaker has wiper edge and is designed for finishing of Steels. It features positive rake angle and positive, moderate T-land. It's also conditionally suitable for Cast irons.

WNMG 060408W-M:T9325	0.8	190	0.45	1.2	–	–	–	180	0.45	1.2	–	–	–	–	–	–	–	–
WNMG 060408W-M:T9415	0.8	255	0.45	1.2	–	–	–	240	0.45	1.2	–	–	–	–	–	–	–	–
WNMG 060412W-M:T5315	1.2	235	0.55	1.2	–	–	–	220	0.55	1.2	–	–	–	–	–	–	–	–
WNMG 060412W-M:T9415	1.2	250	0.55	1.2	–	–	–	235	0.55	1.2	–	–	–	–	–	–	–	–
WNMG 080408W-M:T9325	0.8	185	0.45	1.5	–	–	–	175	0.45	1.5	–	–	–	–	–	–	–	–
WNMG 080408W-M:T9415	0.8	245	0.45	1.5	–	–	–	230	0.45	1.5	–	–	–	–	–	–	–	–
WNMG 080412W-M:T9325	1.2	180	0.55	1.5	–	–	–	170	0.55	1.5	–	–	–	–	–	–	–	–

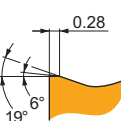
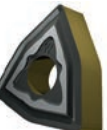

W-MR chip breaker has wiper edge and is designed for finishing of Steels. It features positive rake angle and stable, wide T-land. It's also conditionally suitable for Stainless steels and Cast irons.

WNMG 060408W-MR:T9415	0.8	255	0.45	1.2	–	–	–	240	0.45	1.2	–	–	–	–	–	–	–	–
WNMG 080404W-MR:T9415	0.4	240	0.30	1.5	–	–	–	225	0.30	1.5	–	–	–	–	–	–	–	–
WNMG 080408W-MR:T5315	0.8	230	0.45	1.5	–	–	–	215	0.45	1.5	–	–	–	–	–	–	–	–
WNMG 080408W-MR:T9310	0.8	215	0.45	1.5	–	–	–	200	0.45	1.5	–	–	–	–	–	–	–	–
WNMG 080408W-MR:T9325	0.8	185	0.45	1.5	110	0.41	1.5	175	0.45	1.5	–	–	–	–	–	–	–	–
WNMG 080408W-MR:T9415	0.8	245	0.45	1.5	–	–	–	230	0.45	1.5	–	–	–	–	–	–	–	–
WNMG 080412W-MR:T5315	1.2	230	0.55	1.5	–	–	–	215	0.55	1.5	–	–	–	–	–	–	–	–
WNMG 080412W-MR:T9415	1.2	245	0.55	1.5	–	–	–	230	0.55	1.5	–	–	–	–	–	–	–	–

MEDIUM – NAVIGATOR

SM			<p>SM chip breaker is versatile and the first choice for medium machining of Steels and Super-alloys. It features slightly positive rake angle and stable, moderate T-land. It's also suitable for Stainless steels, Cast irons, and conditionally for Non-ferrous alloys and Hard materials.</p>
M			<p>M chip breaker is versatile and the first choice for medium machining of Cast irons. It features positive rake angle and negative/stable, moderate T-land. It's also suitable for Steels, and conditionally for Hard materials.</p>
SI			<p>SI chip breaker is sharp and designed for medium machining of Steels, Stainless steels. It features positive rake angle without T-land. It's also conditionally suitable for Non-ferrous alloys and Super-alloys.</p>
NMR			<p>NMR chip breaker is versatile and the first choice for medium machining of Stainless steels. It features positive rake angle and positive, wide T-land. It's also suitable for Steels and Super-alloys.</p>
NM			<p>NM chip breaker is sharp and designed for medium machining of Steels, Stainless steels and Super-alloys. It features highly positive rake angle and positive, moderate T-land. It's also conditionally suitable for Non-ferrous alloys.</p>
.NMA			<p>.NMA flat insert is designed for medium machining of Cast irons. It features neutral rake angle without T-land. It's also conditionally suitable for Hard materials.</p>
.NMA ..S			<p>.NMA..S flat insert is designed for medium machining of Cast irons. It features neutral rake angle and negative, moderate T-land. It's also conditionally suitable for Hard materials.</p>

SM

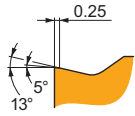

SM chip breaker is versatile and the first choice for medium machining of Steels and Super-alloys. It features slightly positive rake angle and stable, moderate T-land. It's also suitable for Stainless steels, Cast irons, and conditionally for Non-ferrous alloys and Hard materials.



CNMG

	IC (mm)	D1 (mm)	L (mm)	S (mm)
1204	12.700	5.16	12.90	4.76
1606	15.875	6.35	16.10	6.35
1906	19.050	7.94	19.30	6.35

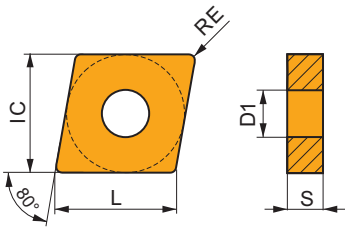

DNMG

	IC (mm)	D1 (mm)	L (mm)	S (mm)
1104	9.525	3.81	11.60	4.76
1504	12.700	5.16	15.50	4.76
1506	12.700	5.16	15.50	6.35

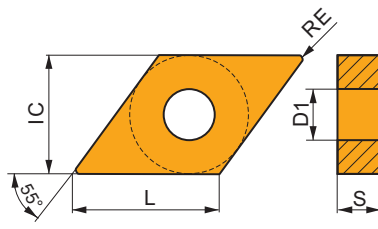

SNMG

	IC (mm)	D1 (mm)	L (mm)	S (mm)
1204	12.700	5.16	12.70	4.76
1906	19.050	7.94	19.05	6.35

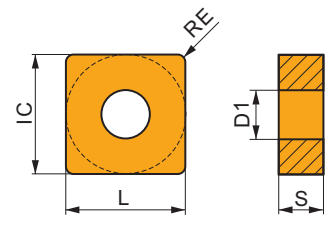

TNMG

	IC (mm)	D1 (mm)	L (mm)	S (mm)
1604	9.525	3.81	16.50	4.76
2204	12.700	5.16	22.00	4.76

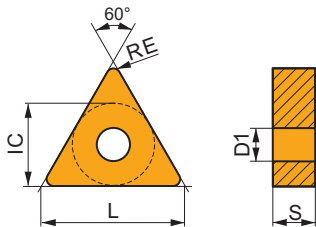

VNMG

	IC (mm)	D1 (mm)	L (mm)	S (mm)
1604	9.525	3.81	16.60	4.76

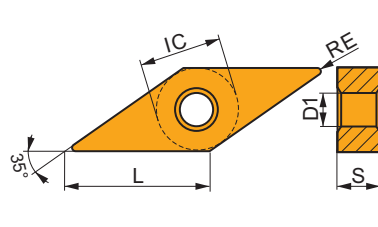

WNMG

	IC (mm)	D1 (mm)	L (mm)	S (mm)
0604	9.525	3.81	6.50	4.76
0804	12.700	5.16	8.70	4.76

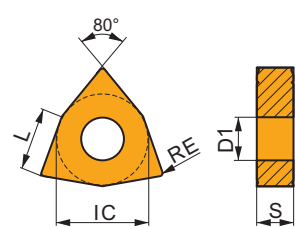

Suitability and starting values for cutting speed (vc), feed (f) and depth of cut (ap). Refer to our Machining Calculator app for further calculations.

Product	RE (mm)	P			M			K			N			S			H		
		vc (m/min)	f (mm/rev)	ap (mm)	vc (m/min)	f (mm/rev)	ap (mm)	vc (m/min)	f (mm/rev)	ap (mm)	vc (m/min)	f (mm/rev)	ap (mm)	vc (m/min)	f (mm/rev)	ap (mm)	vc (m/min)	f (mm/rev)	ap (mm)

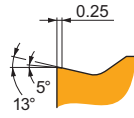

SM chip breaker is versatile and the first choice for medium machining of Steels and Super-alloys. It features slightly positive rake angle and stable, moderate T-land. It's also suitable for Stainless steels, Cast irons, and conditionally for Non-ferrous alloys and Hard materials.

CNMG 120404E-SM:T6310	● 0.4	■ 155	0.20	2.0	■ 110	0.18	2.0	■ 125	0.20	2.0	▣ 465	0.24	2.0	■ 45	0.18	1.6	▣ 30	0.13	0.3
CNMG 120404E-SM:T7325	● 0.4	▣ 180	0.20	2.0	■ 140	0.18	2.0	—	—	—	—	—	—	■ 55	0.18	1.6	—	—	—
CNMG 120404E-SM:T7335	● 0.4	▣ 175	0.20	2.0	■ 135	0.18	2.0	—	—	—	—	—	—	■ 55	0.18	1.6	—	—	—
CNMG 120404E-SM:T8415	● 0.4	■ 200	0.20	2.0	■ 105	0.18	2.0	■ 185	0.20	2.0	▣ 510	0.24	2.0	■ 45	0.18	1.6	▣ 35	0.13	0.3
CNMG 120404E-SM:T8430	● 0.4	■ 180	0.20	2.0	■ 95	0.18	2.0	▣ 145	0.20	2.0	▣ 495	0.24	2.0	▣ 35	0.18	1.6	▣ 30	0.13	0.3
CNMG 120404E-SM:T9325	● 0.4	■ 220	0.20	2.0	■ 130	0.18	2.0	▣ 205	0.20	2.0	—	—	—	▣ 45	0.18	1.6	—	—	—
CNMG 120404E-SM:T9415	● 0.4	■ 280	0.20	2.0	—	—	—	▣ 265	0.20	2.0	—	—	—	—	—	—	▣ 55	0.13	0.3
CNMG 120408E-SM:T6310	⊕ 0.8	■ 175	0.25	2.0	■ 125	0.23	2.0	■ 140	0.25	2.0	▣ 525	0.30	2.0	■ 50	0.20	1.6	▣ 35	0.13	0.7
CNMG 120408E-SM:T7325	⊕ 0.8	▣ 200	0.25	2.0	■ 155	0.23	2.0	—	—	—	—	—	—	■ 65	0.20	1.6	—	—	—
CNMG 120408E-SM:T7335	⊕ 0.8	▣ 190	0.25	2.0	■ 145	0.23	2.0	—	—	—	—	—	—	■ 60	0.20	1.6	—	—	—
CNMG 120408E-SM:T8415	⊕ 0.8	■ 225	0.25	2.0	■ 115	0.23	2.0	■ 205	0.25	2.0	▣ 570	0.30	2.0	■ 50	0.20	1.6	▣ 35	0.13	0.7
CNMG 120408E-SM:T8430	⊕ 0.8	■ 195	0.25	2.0	■ 105	0.23	2.0	▣ 160	0.25	2.0	▣ 540	0.30	2.0	▣ 40	0.20	1.6	▣ 30	0.13	0.7
CNMG 120408E-SM:T9325	⊕ 0.8	■ 235	0.25	2.0	■ 140	0.23	2.0	▣ 220	0.25	2.0	—	—	—	▣ 50	0.20	1.6	—	—	—
CNMG 120408E-SM:T9415	⊕ 0.8	■ 305	0.25	2.0	—	—	—	▣ 285	0.25	2.0	—	—	—	—	—	—	▣ 60	0.13	0.7
CNMG 120412E-SM:T6310	⊕ 1.2	■ 175	0.30	2.0	■ 125	0.27	2.0	■ 140	0.30	2.0	▣ 525	0.36	2.0	■ 50	0.24	1.6	▣ 35	0.15	1.0
CNMG 120412E-SM:T7325	⊕ 1.2	▣ 195	0.30	2.0	■ 150	0.27	2.0	—	—	—	—	—	—	■ 60	0.24	1.6	—	—	—
CNMG 120412E-SM:T7335	⊕ 1.2	▣ 190	0.30	2.0	■ 145	0.27	2.0	—	—	—	—	—	—	■ 60	0.24	1.6	—	—	—
CNMG 120412E-SM:T8415	⊕ 1.2	■ 225	0.30	2.0	■ 115	0.27	2.0	■ 205	0.30	2.0	▣ 570	0.36	2.0	■ 50	0.24	1.6	▣ 35	0.15	1.0
CNMG 120412E-SM:T8430	⊕ 1.2	■ 190	0.30	2.0	■ 105	0.27	2.0	▣ 155	0.30	2.0	▣ 525	0.36	2.0	▣ 40	0.24	1.6	▣ 30	0.15	1.0
CNMG 120412E-SM:T9325	⊕ 1.2	■ 235	0.30	2.0	■ 140	0.27	2.0	▣ 220	0.30	2.0	—	—	—	▣ 50	0.24	1.6	—	—	—
CNMG 120412E-SM:T9415	⊕ 1.2	■ 300	0.30	2.0	—	—	—	▣ 285	0.30	2.0	—	—	—	—	—	—	▣ 60	0.15	1.0
CNMG 160608E-SM:T7325	⊕ 0.8	▣ 185	0.26	3.0	■ 140	0.23	3.0	—	—	—	—	—	—	■ 60	0.23	2.4	—	—	—
CNMG 160608E-SM:T8430	⊕ 0.8	■ 180	0.26	3.0	■ 95	0.23	3.0	▣ 145	0.26	3.0	▣ 495	0.31	3.0	▣ 35	0.23	2.4	▣ 30	0.13	0.7
CNMG 160608E-SM:T9325	⊕ 0.8	■ 225	0.26	3.0	■ 135	0.23	3.0	▣ 210	0.26	3.0	—	—	—	▣ 50	0.23	2.4	—	—	—
CNMG 160612E-SM:T6310	⊕ 1.2	■ 170	0.30	3.0	■ 120	0.27	3.0	■ 135	0.30	3.0	▣ 510	0.36	3.0	■ 50	0.27	2.4	▣ 30	0.15	1.0
CNMG 160612E-SM:T7325	⊕ 1.2	▣ 190	0.30	3.0	■ 145	0.27	3.0	—	—	—	—	—	—	■ 60	0.27	2.4	—	—	—
CNMG 160612E-SM:T7335	⊕ 1.2	▣ 180	0.30	3.0	■ 140	0.27	3.0	—	—	—	—	—	—	■ 55	0.27	2.4	—	—	—
CNMG 160612E-SM:T8415	⊕ 1.2	■ 215	0.30	3.0	■ 110	0.27	3.0	■ 195	0.30	3.0	▣ 540	0.36	3.0	■ 45	0.27	2.4	▣ 35	0.15	1.0
CNMG 160612E-SM:T9325	⊕ 1.2	■ 225	0.30	3.0	■ 135	0.27	3.0	▣ 210	0.30	3.0	—	—	—	▣ 50	0.27	2.4	—	—	—
CNMG 160612E-SM:T9415	⊕ 1.2	■ 290	0.30	3.0	—	—	—	▣ 275	0.30	3.0	—	—	—	—	—	—	▣ 55	0.15	1.0
CNMG 190612E-SM:T6310	⊕ 1.2	■ 165	0.30	4.0	■ 115	0.27	4.0	■ 130	0.30	4.0	▣ 495	0.36	4.0	■ 45	0.27	3.2	▣ 30	0.15	1.0
CNMG 190612E-SM:T7325	⊕ 1.2	▣ 185	0.30	4.0	■ 140	0.27	4.0	—	—	—	—	—	—	■ 60	0.27	3.2	—	—	—
CNMG 190612E-SM:T7335	⊕ 1.2	▣ 175	0.30	4.0	■ 135	0.27	4.0	—	—	—	—	—	—	■ 55	0.27	3.2	—	—	—
CNMG 190612E-SM:T8415	⊕ 1.2	■ 210	0.30	4.0	■ 110	0.27	4.0	■ 190	0.30	4.0	▣ 525	0.36	4.0	■ 45	0.27	3.2	▣ 35	0.15	1.0
CNMG 190612E-SM:T9415	⊕ 1.2	■ 280	0.30	4.0	—	—	—	▣ 265	0.30	4.0	—	—	—	—	—	—	▣ 55	0.15	1.0

Suitability and starting values for cutting speed (vc), feed (f) and depth of cut (ap). Refer to our Machining Calculator app for further calculations.

Product	RE (mm)	P			M			K			N			S			H		
		vc (m/min)	f (mm/rev)	ap (mm)	vc (m/min)	f (mm/rev)	ap (mm)	vc (m/min)	f (mm/rev)	ap (mm)	vc (m/min)	f (mm/rev)	ap (mm)	vc (m/min)	f (mm/rev)	ap (mm)	vc (m/min)	f (mm/rev)	ap (mm)

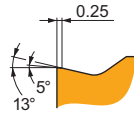

SM chip breaker is versatile and the first choice for medium machining of Steels and Super-alloys. It features slightly positive rake angle and stable, moderate T-land. It's also suitable for Stainless steels, Cast irons, and conditionally for Non-ferrous alloys and Hard materials.

DNMG 110404E-SM:T6310	●	0.4	140	0.20	0.8	100	0.18	0.8	110	0.20	0.8	420	0.24	0.8	40	0.18	0.6	25	0.14	0.3
DNMG 110404E-SM:T7325	●	0.4	160	0.20	0.8	120	0.18	0.8	-	-	-	-	-	-	50	0.18	0.6	-	-	-
DNMG 110404E-SM:T8415	●	0.4	180	0.20	0.8	90	0.18	0.8	160	0.20	0.8	450	0.24	0.8	40	0.18	0.6	30	0.14	0.3
DNMG 110404E-SM:T8430	●	0.4	155	0.20	0.8	85	0.18	0.8	130	0.20	0.8	435	0.24	0.8	30	0.18	0.6	25	0.14	0.3
DNMG 110404E-SM:T9325	●	0.4	190	0.20	0.8	110	0.18	0.8	180	0.20	0.8	-	-	-	40	0.18	0.6	-	-	-
DNMG 110408E-SM:T6310	●	0.8	150	0.25	1.2	105	0.23	1.2	120	0.25	1.2	450	0.30	1.2	45	0.20	1.0	30	0.13	0.7
DNMG 110408E-SM:T7325	●	0.8	170	0.25	1.2	130	0.23	1.2	-	-	-	-	-	-	55	0.20	1.0	-	-	-
DNMG 110408E-SM:T7335	●	0.8	160	0.25	1.2	120	0.23	1.2	-	-	-	-	-	-	50	0.20	1.0	-	-	-
DNMG 110408E-SM:T8415	●	0.8	190	0.25	1.2	100	0.23	1.2	170	0.25	1.2	480	0.30	1.2	40	0.20	1.0	30	0.13	0.7
DNMG 110408E-SM:T8430	●	0.8	170	0.25	1.2	90	0.23	1.2	135	0.25	1.2	465	0.30	1.2	35	0.20	1.0	25	0.13	0.7
DNMG 110408E-SM:T9325	●	0.8	200	0.25	1.2	120	0.23	1.2	190	0.25	1.2	-	-	-	45	0.20	1.0	-	-	-
DNMG 150404E-SM:T6310	●	0.4	130	0.20	1.7	90	0.18	1.7	100	0.20	1.7	390	0.24	1.7	35	0.18	1.4	25	0.14	0.3
DNMG 150404E-SM:T8415	●	0.4	165	0.20	1.7	85	0.18	1.7	150	0.20	1.7	420	0.24	1.7	35	0.18	1.4	25	0.14	0.3
DNMG 150408E-SM:T6310	●	0.8	140	0.25	1.7	100	0.23	1.7	110	0.25	1.7	420	0.30	1.7	40	0.20	1.4	25	0.13	0.7
DNMG 150408E-SM:T8415	●	0.8	185	0.25	1.7	95	0.23	1.7	165	0.25	1.7	465	0.30	1.7	40	0.20	1.4	30	0.13	0.7
DNMG 150604E-SM:T6310	●	0.4	130	0.20	1.7	90	0.18	1.7	100	0.20	1.7	390	0.24	1.7	35	0.18	1.4	25	0.14	0.3
DNMG 150604E-SM:T7325	●	0.4	145	0.20	1.7	110	0.18	1.7	-	-	-	-	-	-	45	0.18	1.4	-	-	-
DNMG 150604E-SM:T7335	●	0.4	140	0.20	1.7	105	0.18	1.7	-	-	-	-	-	-	45	0.18	1.4	-	-	-
DNMG 150604E-SM:T8415	●	0.4	165	0.20	1.7	85	0.18	1.7	150	0.20	1.7	420	0.24	1.7	35	0.18	1.4	25	0.14	0.3
DNMG 150604E-SM:T8430	●	0.4	145	0.20	1.7	80	0.18	1.7	120	0.20	1.7	405	0.24	1.7	30	0.18	1.4	25	0.14	0.3
DNMG 150604E-SM:T9325	●	0.4	180	0.20	1.7	105	0.18	1.7	170	0.20	1.7	-	-	-	40	0.18	1.4	-	-	-
DNMG 150604E-SM:T9415	●	0.4	225	0.20	1.7	-	-	-	210	0.20	1.7	-	-	-	-	-	-	45	0.14	0.3
DNMG 150608E-SM:T6310	●	0.8	140	0.25	1.7	100	0.23	1.7	110	0.25	1.7	420	0.30	1.7	40	0.20	1.4	25	0.13	0.7
DNMG 150608E-SM:T7325	●	0.8	160	0.25	1.7	120	0.23	1.7	-	-	-	-	-	-	50	0.20	1.4	-	-	-
DNMG 150608E-SM:T7335	●	0.8	155	0.25	1.7	120	0.23	1.7	-	-	-	-	-	-	50	0.20	1.4	-	-	-
DNMG 150608E-SM:T8415	●	0.8	185	0.25	1.7	95	0.23	1.7	165	0.25	1.7	465	0.30	1.7	40	0.20	1.4	30	0.13	0.7
DNMG 150608E-SM:T8430	●	0.8	155	0.25	1.7	85	0.23	1.7	130	0.25	1.7	435	0.30	1.7	30	0.20	1.4	25	0.13	0.7
DNMG 150608E-SM:T9325	●	0.8	195	0.25	1.7	115	0.23	1.7	185	0.25	1.7	-	-	-	40	0.20	1.4	-	-	-
DNMG 150608E-SM:T9415	●	0.8	250	0.25	1.7	-	-	-	235	0.25	1.7	-	-	-	-	-	-	50	0.13	0.7
DNMG 150612E-SM:T6310	●	1.2	145	0.30	1.7	100	0.27	1.7	115	0.30	1.7	435	0.36	1.7	40	0.24	1.4	25	0.15	0.9
DNMG 150612E-SM:T7325	●	1.2	160	0.30	1.7	120	0.27	1.7	-	-	-	-	-	-	50	0.24	1.4	-	-	-
DNMG 150612E-SM:T8415	●	1.2	185	0.30	1.7	95	0.27	1.7	165	0.30	1.7	465	0.36	1.7	40	0.24	1.4	30	0.15	0.9
DNMG 150612E-SM:T8430	●	1.2	155	0.30	1.7	85	0.27	1.7	130	0.30	1.7	435	0.36	1.7	30	0.24	1.4	25	0.15	0.9
DNMG 150612E-SM:T9415	●	1.2	245	0.30	1.7	-	-	-	230	0.30	1.7	-	-	-	-	-	-	45	0.15	0.9

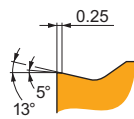
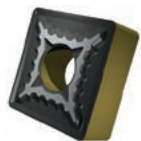

SM chip breaker is versatile and the first choice for medium machining of Steels and Super-alloys. It features slightly positive rake angle and stable, moderate T-land. It's also suitable for Stainless steels, Cast irons, and conditionally for Non-ferrous alloys and Hard materials.

SNMG 120408E-SM:T6310	●	0.8	185	0.25	1.8	130	0.23	1.8	145	0.25	1.8	555	0.30	1.8	55	0.20	1.4	35	0.13	0.7
SNMG 120408E-SM:T7325	●	0.8	210	0.25	1.8	160	0.23	1.8	-	-	-	-	-	-	65	0.20	1.4	-	-	-
SNMG 120408E-SM:T7335	●	0.8	205	0.25	1.8	155	0.23	1.8	-	-	-	-	-	-	65	0.20	1.4	-	-	-
SNMG 120408E-SM:T8415	●	0.8	240	0.25	1.8	125	0.23	1.8	215	0.25	1.8	600	0.30	1.8	55	0.20	1.4	40	0.13	0.7
SNMG 120408E-SM:T8430	●	0.8	205	0.25	1.8	110	0.23	1.8	170	0.25	1.8	570	0.30	1.8	45	0.20	1.4	35	0.13	0.7
SNMG 120408E-SM:T9325	●	0.8	255	0.25	1.8	150	0.23	1.8	240	0.25	1.8	-	-	-	55	0.20	1.4	-	-	-
SNMG 120408E-SM:T9415	●	0.8	325	0.25	1.8	-	-	-	305	0.25	1.8	-	-	-	-	-	-	65	0.13	0.7
SNMG 120412E-SM:T7325	●	1.2	210	0.30	1.8	160	0.27	1.8	-	-	-	-	-	-	65	0.24	1.4	-	-	-
SNMG 120412E-SM:T9415	●	1.2	325	0.30	1.8	-	-	-	305	0.30	1.8	-	-	-	-	-	-	65	0.15	1.0
SNMG 190612E-SM:T6310	●	1.2	175	0.30	4.0	125	0.27	4.0	140	0.30	4.0	525	0.36	4.0	50	0.27	3.2	35	0.15	1.0
SNMG 190612E-SM:T7325	●	1.2	195	0.30	4.0	150	0.27	4.0	-	-	-	-	-	-	60	0.27	3.2	-	-	-
SNMG 190612E-SM:T7335	●	1.2	185	0.30	4.0	140	0.27	4.0	-	-	-	-	-	-	60	0.27	3.2	-	-	-
SNMG 190612E-SM:T8415	●	1.2	220	0.30	4.0	115	0.27	4.0	200	0.30	4.0	555	0.36	4.0	50	0.27	3.2	35	0.15	1.0
SNMG 190612E-SM:T9325	●	1.2	230	0.30	4.0	135	0.27	4.0	215	0.30	4.0	-	-	-	50	0.27	3.2	-	-	-
SNMG 190616E-SM:T7335	●	1.6	175	0.40	4.0	135	0.36	4.0	-	-	-	-	-	-	55	0.32	3.2	-	-	-
SNMG 190616E-SM:T9325	●	1.6	210	0.40	4.0	125	0.36	4.0	195	0.40	4.0	-	-	-	45	0.32	3.2	-	-	-

Suitability and starting values for cutting speed (vc), feed (f) and depth of cut (ap). Refer to our Machining Calculator app for further calculations.

Product	RE (mm)	P			M			K			N			S			H		
		vc (m/min)	f (mm/rev)	ap (mm)	vc (m/min)	f (mm/rev)	ap (mm)	vc (m/min)	f (mm/rev)	ap (mm)	vc (m/min)	f (mm/rev)	ap (mm)	vc (m/min)	f (mm/rev)	ap (mm)	vc (m/min)	f (mm/rev)	ap (mm)

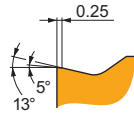
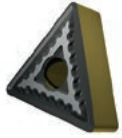

SM chip breaker is versatile and the first choice for medium machining of Steels and Super-alloys. It features slightly positive rake angle and stable, moderate T-land. It's also suitable for Stainless steels, Cast irons, and conditionally for Non-ferrous alloys and Hard materials.

TNMG 160404E-SM-T6310	● 0.4	■ 135	0.20	1.7	■ 95	0.18	1.7	■ 105	0.20	1.7	▣ 405	0.24	1.7	■ 40	0.18	1.4	▣ 25	0.14	0.3
TNMG 160404E-SM-T7325	● 0.4	▣ 155	0.20	1.7	■ 120	0.18	1.7	—	—	—	—	—	—	■ 50	0.18	1.4	—	—	—
TNMG 160404E-SM-T7335	● 0.4	▣ 150	0.20	1.7	■ 115	0.18	1.7	—	—	—	—	—	—	■ 45	0.18	1.4	—	—	—
TNMG 160404E-SM-T8415	● 0.4	■ 170	0.20	1.7	■ 90	0.18	1.7	■ 155	0.20	1.7	▣ 435	0.24	1.7	■ 35	0.18	1.4	▣ 30	0.14	0.3
TNMG 160404E-SM-T8430	● 0.4	■ 155	0.20	1.7	■ 85	0.18	1.7	▣ 130	0.20	1.7	▣ 435	0.24	1.7	▣ 30	0.18	1.4	▣ 25	0.14	0.3
TNMG 160404E-SM-T9325	● 0.4	■ 190	0.20	1.7	■ 110	0.18	1.7	▣ 180	0.20	1.7	—	—	—	▣ 40	0.18	1.4	—	—	—
TNMG 160404E-SM-T9415	● 0.4	■ 240	0.20	1.7	—	—	—	▣ 225	0.20	1.7	—	—	—	—	—	—	▣ 45	0.14	0.3
TNMG 160408E-SM-T6310	● 0.8	■ 150	0.25	1.7	■ 105	0.23	1.7	■ 120	0.25	1.7	▣ 450	0.30	1.7	■ 45	0.20	1.4	▣ 30	0.13	0.7
TNMG 160408E-SM-T7325	● 0.8	▣ 170	0.25	1.7	■ 130	0.23	1.7	—	—	—	—	—	—	■ 55	0.20	1.4	—	—	—
TNMG 160408E-SM-T7335	● 0.8	▣ 165	0.25	1.7	■ 125	0.23	1.7	—	—	—	—	—	—	■ 50	0.20	1.4	—	—	—
TNMG 160408E-SM-T8415	● 0.8	■ 195	0.25	1.7	■ 100	0.23	1.7	■ 180	0.25	1.7	▣ 495	0.30	1.7	■ 45	0.20	1.4	▣ 30	0.13	0.7
TNMG 160408E-SM-T8430	● 0.8	■ 170	0.25	1.7	■ 90	0.23	1.7	▣ 135	0.25	1.7	▣ 465	0.30	1.7	▣ 35	0.20	1.4	▣ 25	0.13	0.7
TNMG 160408E-SM-T9325	● 0.8	■ 205	0.25	1.7	■ 120	0.23	1.7	▣ 190	0.25	1.7	—	—	—	▣ 45	0.20	1.4	—	—	—
TNMG 160408E-SM-T9415	● 0.8	■ 265	0.25	1.7	—	—	—	▣ 250	0.25	1.7	—	—	—	—	—	—	▣ 50	0.13	0.7
TNMG 160412E-SM-T6310	● 1.2	■ 155	0.30	1.7	■ 110	0.27	1.7	■ 125	0.30	1.7	▣ 465	0.36	1.7	■ 45	0.24	1.4	▣ 30	0.15	0.9
TNMG 160412E-SM-T7325	● 1.2	▣ 170	0.30	1.7	■ 130	0.27	1.7	—	—	—	—	—	—	■ 55	0.24	1.4	—	—	—
TNMG 160412E-SM-T7335	● 1.2	▣ 165	0.30	1.7	■ 125	0.27	1.7	—	—	—	—	—	—	■ 50	0.24	1.4	—	—	—
TNMG 160412E-SM-T8415	● 1.2	■ 195	0.30	1.7	■ 100	0.27	1.7	■ 180	0.30	1.7	▣ 495	0.36	1.7	■ 45	0.24	1.4	▣ 30	0.15	0.9
TNMG 160412E-SM-T9325	● 1.2	■ 205	0.30	1.7	■ 120	0.27	1.7	▣ 190	0.30	1.7	—	—	—	▣ 45	0.24	1.4	—	—	—
TNMG 220404E-SM-T6310	● 0.4	■ 135	0.20	1.7	■ 95	0.18	1.7	■ 105	0.20	1.7	▣ 405	0.24	1.7	■ 40	0.18	1.4	▣ 25	0.14	0.3
TNMG 220404E-SM-T7325	● 0.4	▣ 155	0.20	1.7	■ 120	0.18	1.7	—	—	—	—	—	—	■ 50	0.18	1.4	—	—	—
TNMG 220404E-SM-T8415	● 0.4	■ 170	0.20	1.7	■ 90	0.18	1.7	■ 155	0.20	1.7	▣ 435	0.24	1.7	■ 35	0.18	1.4	▣ 30	0.14	0.3
TNMG 220404E-SM-T8430	● 0.4	■ 155	0.20	1.7	■ 85	0.18	1.7	▣ 130	0.20	1.7	▣ 435	0.24	1.7	▣ 30	0.18	1.4	▣ 25	0.14	0.3
TNMG 220404E-SM-T9325	● 0.4	■ 190	0.20	1.7	■ 110	0.18	1.7	▣ 180	0.20	1.7	—	—	—	▣ 40	0.18	1.4	—	—	—
TNMG 220408E-SM-T6310	● 0.8	■ 150	0.25	1.7	■ 105	0.23	1.7	■ 120	0.25	1.7	▣ 450	0.30	1.7	■ 45	0.20	1.4	▣ 30	0.13	0.7
TNMG 220408E-SM-T7325	● 0.8	▣ 170	0.25	1.7	■ 130	0.23	1.7	—	—	—	—	—	—	■ 55	0.20	1.4	—	—	—
TNMG 220408E-SM-T7335	● 0.8	▣ 165	0.25	1.7	■ 125	0.23	1.7	—	—	—	—	—	—	■ 50	0.20	1.4	—	—	—
TNMG 220408E-SM-T8415	● 0.8	■ 195	0.25	1.7	■ 100	0.23	1.7	■ 180	0.25	1.7	▣ 495	0.30	1.7	■ 45	0.20	1.4	▣ 30	0.13	0.7
TNMG 220408E-SM-T8430	● 0.8	■ 170	0.25	1.7	■ 90	0.23	1.7	▣ 135	0.25	1.7	▣ 465	0.30	1.7	▣ 35	0.20	1.4	▣ 25	0.13	0.7
TNMG 220408E-SM-T9325	● 0.8	■ 205	0.25	1.7	■ 120	0.23	1.7	▣ 190	0.25	1.7	—	—	—	▣ 45	0.20	1.4	—	—	—
TNMG 220408E-SM-T9415	● 0.8	■ 265	0.25	1.7	—	—	—	▣ 250	0.25	1.7	—	—	—	—	—	—	▣ 50	0.13	0.7
TNMG 220412E-SM-T6310	● 1.2	■ 155	0.30	1.7	■ 110	0.27	1.7	■ 125	0.30	1.7	▣ 465	0.36	1.7	■ 45	0.24	1.4	▣ 30	0.15	0.9
TNMG 220412E-SM-T7325	● 1.2	▣ 170	0.30	1.7	■ 130	0.27	1.7	—	—	—	—	—	—	■ 55	0.24	1.4	—	—	—
TNMG 220412E-SM-T7335	● 1.2	▣ 165	0.30	1.7	■ 125	0.27	1.7	—	—	—	—	—	—	■ 50	0.24	1.4	—	—	—
TNMG 220412E-SM-T8415	● 1.2	■ 195	0.30	1.7	■ 100	0.27	1.7	■ 180	0.30	1.7	▣ 495	0.36	1.7	■ 45	0.24	1.4	▣ 30	0.15	0.9
TNMG 220412E-SM-T9325	● 1.2	■ 205	0.30	1.7	■ 120	0.27	1.7	▣ 190	0.30	1.7	—	—	—	▣ 45	0.24	1.4	—	—	—
TNMG 220412E-SM-T9415	● 1.2	■ 260	0.30	1.7	—	—	—	▣ 245	0.30	1.7	—	—	—	—	—	—	▣ 50	0.15	0.9

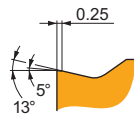

SM chip breaker is versatile and the first choice for medium machining of Steels and Super-alloys. It features slightly positive rake angle and stable, moderate T-land. It's also suitable for Stainless steels, Cast irons, and conditionally for Non-ferrous alloys and Hard materials.

VNMG 160404E-SM-T6310	● 0.4	■ 120	0.18	1.2	■ 85	0.16	1.2	■ 95	0.18	1.2	▣ 360	0.22	1.2	■ 35	0.16	1.0	▣ 20	0.13	0.3
VNMG 160404E-SM-T7325	● 0.4	▣ 135	0.18	1.2	■ 105	0.16	1.2	—	—	—	—	—	—	■ 40	0.16	1.0	—	—	—
VNMG 160404E-SM-T8415	● 0.4	■ 155	0.18	1.2	■ 80	0.16	1.2	■ 140	0.18	1.2	▣ 390	0.22	1.2	■ 35	0.16	1.0	▣ 25	0.13	0.3
VNMG 160404E-SM-T8430	● 0.4	■ 135	0.18	1.2	■ 75	0.16	1.2	▣ 110	0.18	1.2	▣ 375	0.22	1.2	▣ 25	0.16	1.0	▣ 20	0.13	0.3
VNMG 160404E-SM-T9325	● 0.4	■ 170	0.18	1.2	■ 100	0.16	1.2	▣ 160	0.18	1.2	—	—	—	▣ 35	0.16	1.0	—	—	—
VNMG 160404E-SM-T9415	● 0.4	■ 210	0.18	1.2	—	—	—	▣ 195	0.18	1.2	—	—	—	—	—	—	▣ 40	0.13	0.3
VNMG 160408E-SM-T6310	● 0.8	■ 125	0.25	1.4	■ 90	0.23	1.4	■ 100	0.25	1.4	▣ 375	0.30	1.4	■ 35	0.20	1.1	▣ 25	0.13	0.7
VNMG 160408E-SM-T7325	● 0.8	▣ 145	0.25	1.4	■ 110	0.23	1.4	—	—	—	—	—	—	■ 45	0.20	1.1	—	—	—
VNMG 160408E-SM-T8415	● 0.8	■ 160	0.25	1.4	■ 85	0.23	1.4	■ 145	0.25	1.4	▣ 405	0.30	1.4	■ 35	0.20	1.1	▣ 25	0.13	0.7
VNMG 160408E-SM-T8430	● 0.8	■ 140	0.25	1.4	■ 75	0.23	1.4	▣ 115	0.25	1.4	▣ 390	0.30	1.4	▣ 30	0.20	1.1	▣ 20	0.13	0.7
VNMG 160408E-SM-T9325	● 0.8	■ 170	0.25	1.4	■ 100	0.23	1.4	▣ 160	0.25	1.4	—	—	—	▣ 35	0.20	1.1	—	—	—

Suitability and starting values for cutting speed (vc), feed (f) and depth of cut (ap). Refer to our Machining Calculator app for further calculations.

Product	RE (mm)	P			M			K			N			S			H		
		vc (m/min)	f (mm/rev)	ap (mm)	vc (m/min)	f (mm/rev)	ap (mm)	vc (m/min)	f (mm/rev)	ap (mm)	vc (m/min)	f (mm/rev)	ap (mm)	vc (m/min)	f (mm/rev)	ap (mm)	vc (m/min)	f (mm/rev)	ap (mm)

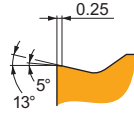
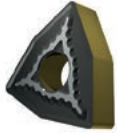

SM chip breaker is versatile and the first choice for medium machining of Steels and Super-alloys. It features slightly positive rake angle and stable, moderate T-land. It's also suitable for Stainless steels, Cast irons, and conditionally for Non-ferrous alloys and Hard materials.

WNMG 060404E-SM:T7335	●	0.4	180	0.20	1.7	140	0.18	1.7	—	—	—	—	—	—	55	0.18	1.4	—	—	—
WNMG 060404E-SM:T8430	●	0.4	185	0.20	1.7	100	0.18	1.7	150	0.20	1.7	510	0.24	1.7	40	0.18	1.4	30	0.13	0.3
WNMG 060404E-SM:T9325	●	0.4	225	0.20	1.7	135	0.18	1.7	210	0.20	1.7	—	—	—	50	0.18	1.4	—	—	—
WNMG 060408E-SM:T6310	●	0.8	175	0.25	1.7	125	0.23	1.7	140	0.25	1.7	525	0.30	1.7	50	0.20	1.4	35	0.13	0.7
WNMG 060408E-SM:T7325	●	0.8	200	0.25	1.7	155	0.23	1.7	—	—	—	—	—	—	65	0.20	1.4	—	—	—
WNMG 060408E-SM:T7335	●	0.8	195	0.25	1.7	150	0.23	1.7	—	—	—	—	—	—	60	0.20	1.4	—	—	—
WNMG 060408E-SM:T8415	●	0.8	225	0.25	1.7	115	0.23	1.7	205	0.25	1.7	570	0.30	1.7	50	0.20	1.4	35	0.13	0.7
WNMG 060408E-SM:T8430	●	0.8	195	0.25	1.7	105	0.23	1.7	160	0.25	1.7	540	0.30	1.7	40	0.20	1.4	30	0.13	0.7
WNMG 060408E-SM:T9325	●	0.8	240	0.25	1.7	140	0.23	1.7	225	0.25	1.7	—	—	—	50	0.20	1.4	—	—	—
WNMG 060412E-SM:T7325	●	1.2	200	0.30	1.7	155	0.27	1.7	—	—	—	—	—	—	65	0.24	1.4	—	—	—
WNMG 060412E-SM:T8430	●	1.2	195	0.30	1.7	105	0.27	1.7	160	0.30	1.7	540	0.36	1.7	40	0.24	1.4	30	0.15	1.0
WNMG 060412E-SM:T9325	●	1.2	240	0.30	1.7	140	0.27	1.7	225	0.30	1.7	—	—	—	50	0.24	1.4	—	—	—
WNMG 080404E-SM:T6310	●	0.4	155	0.20	2.0	110	0.18	2.0	125	0.20	2.0	465	0.24	2.0	45	0.18	1.6	30	0.13	0.3
WNMG 080404E-SM:T7325	●	0.4	180	0.20	2.0	140	0.18	2.0	—	—	—	—	—	—	55	0.18	1.6	—	—	—
WNMG 080404E-SM:T7335	●	0.4	175	0.20	2.0	135	0.18	2.0	—	—	—	—	—	—	55	0.18	1.6	—	—	—
WNMG 080404E-SM:T8415	●	0.4	200	0.20	2.0	105	0.18	2.0	185	0.20	2.0	510	0.24	2.0	45	0.18	1.6	35	0.13	0.3
WNMG 080404E-SM:T8430	●	0.4	180	0.20	2.0	95	0.18	2.0	145	0.20	2.0	495	0.24	2.0	35	0.18	1.6	30	0.13	0.3
WNMG 080404E-SM:T9325	●	0.4	220	0.20	2.0	130	0.18	2.0	205	0.20	2.0	—	—	—	45	0.18	1.6	—	—	—
WNMG 080404E-SM:T9415	●	0.4	280	0.20	2.0	—	—	—	265	0.20	2.0	—	—	—	—	—	—	55	0.13	0.3
WNMG 080408E-SM:T6310	●	0.8	175	0.25	2.0	125	0.23	2.0	140	0.25	2.0	525	0.30	2.0	50	0.20	1.6	35	0.13	0.7
WNMG 080408E-SM:T7325	●	0.8	200	0.25	2.0	155	0.23	2.0	—	—	—	—	—	—	65	0.20	1.6	—	—	—
WNMG 080408E-SM:T7335	●	0.8	190	0.25	2.0	145	0.23	2.0	—	—	—	—	—	—	60	0.20	1.6	—	—	—
WNMG 080408E-SM:T8415	●	0.8	225	0.25	2.0	115	0.23	2.0	205	0.25	2.0	570	0.30	2.0	50	0.20	1.6	35	0.13	0.7
WNMG 080408E-SM:T8430	●	0.8	195	0.25	2.0	105	0.23	2.0	160	0.25	2.0	540	0.30	2.0	40	0.20	1.6	30	0.13	0.7
WNMG 080408E-SM:T9325	●	0.8	235	0.25	2.0	140	0.23	2.0	220	0.25	2.0	—	—	—	50	0.20	1.6	—	—	—
WNMG 080408E-SM:T9415	●	0.8	305	0.25	2.0	—	—	—	285	0.25	2.0	—	—	—	—	—	—	60	0.13	0.7
WNMG 080412E-SM:T6310	●	1.2	175	0.30	2.0	125	0.27	2.0	140	0.30	2.0	525	0.36	2.0	50	0.24	1.6	35	0.15	1.0
WNMG 080412E-SM:T7325	●	1.2	195	0.30	2.0	150	0.27	2.0	—	—	—	—	—	—	60	0.24	1.6	—	—	—
WNMG 080412E-SM:T7335	●	1.2	190	0.30	2.0	145	0.27	2.0	—	—	—	—	—	—	60	0.24	1.6	—	—	—
WNMG 080412E-SM:T8415	●	1.2	225	0.30	2.0	115	0.27	2.0	205	0.30	2.0	570	0.36	2.0	50	0.24	1.6	35	0.15	1.0
WNMG 080412E-SM:T8430	●	1.2	190	0.30	2.0	105	0.27	2.0	155	0.30	2.0	525	0.36	2.0	40	0.24	1.6	30	0.15	1.0
WNMG 080412E-SM:T9325	●	1.2	235	0.30	2.0	140	0.27	2.0	220	0.30	2.0	—	—	—	50	0.24	1.6	—	—	—
WNMG 080412E-SM:T9415	●	1.2	300	0.30	2.0	—	—	—	285	0.30	2.0	—	—	—	—	—	—	60	0.15	1.0

M

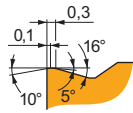

M chip breaker is versatile and the first choice for medium machining of Cast irons. It features positive rake angle and negative/stable, moderate T-land. It's also suitable for Steels, and conditionally for Hard materials.



CNMG

	IC (mm)	D1 (mm)	L (mm)	S (mm)
0903	9.525	3.81	9.70	3.18
1204	12.700	5.16	12.90	4.76
1606	15.875	6.35	16.10	6.35
1906	19.050	7.94	19.30	6.35

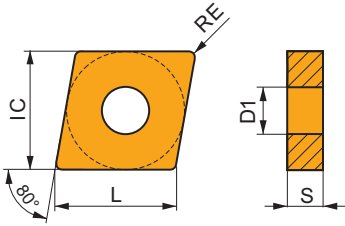

DNMG

	IC (mm)	D1 (mm)	L (mm)	S (mm)
1104	9.525	3.81	11.60	4.76
1504	12.700	5.16	15.50	4.76
1506	12.700	5.16	15.50	6.35

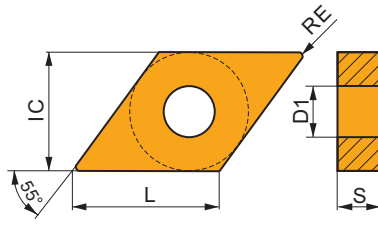

SNMG

	IC (mm)	D1 (mm)	L (mm)	S (mm)
1204	12.700	5.16	12.70	4.76
1506	15.875	6.35	15.88	6.35
1906	19.050	7.94	19.05	6.35

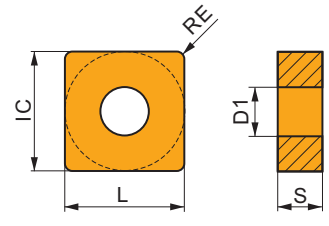

TNMG

	IC (mm)	D1 (mm)	L (mm)	S (mm)
1604	9.525	3.81	16.50	4.76
2204	12.700	5.16	22.00	4.76

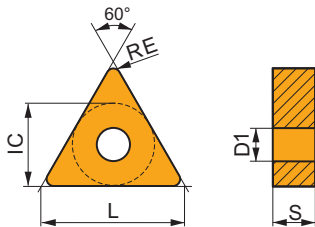

VNMG

	IC (mm)	D1 (mm)	L (mm)	S (mm)
1604	9.525	3.81	16.60	4.76

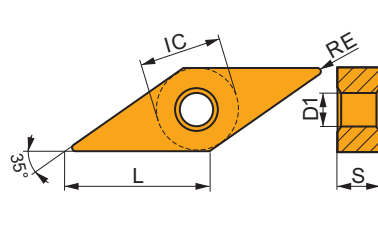

WNMG

	IC (mm)	D1 (mm)	L (mm)	S (mm)
0604	9.525	3.81	6.50	4.76
0804	12.700	5.16	8.70	4.76

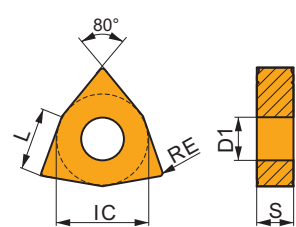

Suitability and starting values for cutting speed (vc), feed (f) and depth of cut (ap). Refer to our Machining Calculator app for further calculations.

Product	RE (mm)	P			M			K			N			S			H		
		vc (m/min)	f (mm/rev)	ap (mm)	vc (m/min)	f (mm/rev)	ap (mm)	vc (m/min)	f (mm/rev)	ap (mm)	vc (m/min)	f (mm/rev)	ap (mm)	vc (m/min)	f (mm/rev)	ap (mm)	vc (m/min)	f (mm/rev)	ap (mm)

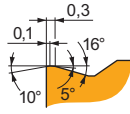
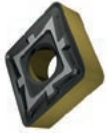

M chip breaker is versatile and the first choice for medium machining of Cast irons. It features positive rake angle and negative/stable, moderate T-land. It's also suitable for Steels, and conditionally for Hard materials.

CNMG 090308E-M-T9325	0.8	205	0.32	1.8	-	-	-	190	0.32	1.8	-	-	-	-	-	-	-	-
CNMG 090308E-M-T9335	0.8	180	0.32	1.8	-	-	-	-	-	-	-	-	-	-	-	-	-	-
CNMG 090308E-M-T9415	0.8	275	0.32	1.8	-	-	-	260	0.32	1.8	-	-	-	-	-	55	0.16	0.5
CNMG 120404E-M-T5315	0.4	245	0.20	2.1	-	-	-	230	0.20	2.1	-	-	-	-	-	45	0.13	0.3
CNMG 120404E-M-T9325	0.4	210	0.20	2.1	-	-	-	195	0.20	2.1	-	-	-	-	-	-	-	-
CNMG 120404E-M-T9335	0.4	180	0.20	2.1	-	-	-	-	-	-	-	-	-	-	-	-	-	-
CNMG 120404E-M-T9415	0.4	265	0.20	2.1	-	-	-	250	0.20	2.1	-	-	-	-	-	50	0.13	0.3
CNMG 120408E-M:6640	0.8	165	0.32	2.1	-	-	-	155	0.32	2.1	-	-	-	-	-	-	-	-
CNMG 120408E-M-T5305	0.8	280	0.32	2.1	-	-	-	265	0.32	2.1	-	-	-	-	-	55	0.16	0.7
CNMG 120408E-M-T5315	0.8	250	0.32	2.1	-	-	-	235	0.32	2.1	-	-	-	-	-	50	0.16	0.7
CNMG 120408E-M-T8430	0.8	170	0.32	2.1	-	-	-	135	0.32	2.1	-	-	-	-	-	25	0.16	0.7
CNMG 120408E-M-T9310	0.8	245	0.32	2.1	-	-	-	230	0.32	2.1	-	-	-	-	-	45	0.16	0.7
CNMG 120408E-M-T9315	0.8	225	0.32	2.1	-	-	-	210	0.32	2.1	-	-	-	-	-	45	0.16	0.7
CNMG 120408E-M-T9325	0.8	200	0.32	2.1	-	-	-	190	0.32	2.1	-	-	-	-	-	-	-	-
CNMG 120408E-M-T9335	0.8	180	0.32	2.1	-	-	-	-	-	-	-	-	-	-	-	-	-	-
CNMG 120408E-M-T9415	0.8	270	0.32	2.1	-	-	-	255	0.32	2.1	-	-	-	-	-	50	0.16	0.7
CNMG 120412E-M-T5305	1.2	275	0.40	2.1	-	-	-	260	0.40	2.1	-	-	-	-	-	55	0.20	1.0
CNMG 120412E-M-T5315	1.2	245	0.40	2.1	-	-	-	230	0.40	2.1	-	-	-	-	-	45	0.20	1.0
CNMG 120412E-M-T9315	1.2	220	0.40	2.1	-	-	-	205	0.40	2.1	-	-	-	-	-	40	0.20	1.0
CNMG 120412E-M-T9325	1.2	195	0.40	2.1	-	-	-	185	0.40	2.1	-	-	-	-	-	-	-	-
CNMG 120412E-M-T9335	1.2	170	0.40	2.1	-	-	-	-	-	-	-	-	-	-	-	-	-	-
CNMG 120412E-M-T9415	1.2	265	0.40	2.1	-	-	-	250	0.40	2.1	-	-	-	-	-	50	0.20	1.0
CNMG 120416E-M-T9325	1.6	200	0.40	2.1	-	-	-	190	0.40	2.1	-	-	-	-	-	-	-	-
CNMG 120416E-M-T9335	1.6	175	0.40	2.1	-	-	-	-	-	-	-	-	-	-	-	-	-	-
CNMG 160608E-M-T9310	0.8	235	0.32	3.6	-	-	-	220	0.32	3.6	-	-	-	-	-	45	0.16	0.7
CNMG 160608E-M-T9325	0.8	190	0.32	3.6	-	-	-	180	0.32	3.6	-	-	-	-	-	-	-	-
CNMG 160608E-M-T9335	0.8	170	0.32	3.6	-	-	-	-	-	-	-	-	-	-	-	-	-	-
CNMG 160608E-M-T9415	0.8	255	0.32	3.6	-	-	-	240	0.32	3.6	-	-	-	-	-	50	0.16	0.7
CNMG 160612E-M-T9325	1.2	185	0.40	3.6	-	-	-	175	0.40	3.6	-	-	-	-	-	-	-	-
CNMG 160612E-M-T9335	1.2	160	0.40	3.6	-	-	-	-	-	-	-	-	-	-	-	-	-	-
CNMG 160612E-M-T9415	1.2	250	0.40	3.6	-	-	-	235	0.40	3.6	-	-	-	-	-	50	0.20	1.0
CNMG 160616E-M-T9325	1.6	190	0.40	3.6	-	-	-	180	0.40	3.6	-	-	-	-	-	-	-	-
CNMG 160616E-M-T9335	1.6	165	0.40	3.6	-	-	-	-	-	-	-	-	-	-	-	-	-	-
CNMG 190608E-M:6630	0.8	175	0.32	4.2	-	-	-	165	0.32	4.2	-	-	-	-	-	-	-	-
CNMG 190608E-M-T9325	0.8	190	0.32	4.2	-	-	-	180	0.32	4.2	-	-	-	-	-	-	-	-
CNMG 190608E-M-T9335	0.8	165	0.32	4.2	-	-	-	-	-	-	-	-	-	-	-	-	-	-
CNMG 190608E-M-T9415	0.8	250	0.32	4.2	-	-	-	235	0.32	4.2	-	-	-	-	-	50	0.16	0.7
CNMG 190612E-M:6630	1.2	170	0.40	4.2	-	-	-	160	0.40	4.2	-	-	-	-	-	-	-	-
CNMG 190612E-M:6640	1.2	145	0.40	4.2	-	-	-	135	0.40	4.2	-	-	-	-	-	-	-	-
CNMG 190612E-M-T9325	1.2	185	0.40	4.2	-	-	-	175	0.40	4.2	-	-	-	-	-	-	-	-
CNMG 190612E-M-T9335	1.2	160	0.40	4.2	-	-	-	-	-	-	-	-	-	-	-	-	-	-
CNMG 190612E-M-T9415	1.2	245	0.40	4.2	-	-	-	230	0.40	4.2	-	-	-	-	-	45	0.20	1.0
CNMG 190616E-M-T9325	1.6	190	0.40	4.2	-	-	-	180	0.40	4.2	-	-	-	-	-	-	-	-
CNMG 190616E-M-T9335	1.6	165	0.40	4.2	-	-	-	-	-	-	-	-	-	-	-	-	-	-
CNMG 190616E-M-T9415	1.6	255	0.40	4.2	-	-	-	240	0.40	4.2	-	-	-	-	-	50	0.20	1.3

Suitability and starting values for cutting speed (vc), feed (f) and depth of cut (ap). Refer to our Machining Calculator app for further calculations.

Product	RE (mm)	P			M			K			N			S			H		
		vc (m/min)	f (mm/rev)	ap (mm)	vc (m/min)	f (mm/rev)	ap (mm)	vc (m/min)	f (mm/rev)	ap (mm)	vc (m/min)	f (mm/rev)	ap (mm)	vc (m/min)	f (mm/rev)	ap (mm)	vc (m/min)	f (mm/rev)	ap (mm)

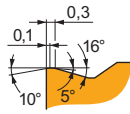

M chip breaker is versatile and the first choice for medium machining of Cast irons. It features positive rake angle and negative/stable, moderate T-land. It's also suitable for Steels, and conditionally for Hard materials.

DNMG 110404E-M:T5315	0.4	210	0.20	1.2	-	-	-	195	0.20	1.2	-	-	-	-	-	-	40	0.14	0.3
DNMG 110404E-M:T9325	0.4	175	0.20	1.2	-	-	-	165	0.20	1.2	-	-	-	-	-	-	-	-	-
DNMG 110404E-M:T9335	0.4	150	0.20	1.2	-	-	-	-	-	-	-	-	-	-	-	-	-	-	-
DNMG 110404E-M:T9415	0.4	225	0.20	1.2	-	-	-	210	0.20	1.2	-	-	-	-	-	-	45	0.14	0.3
DNMG 110408E-M:T5315	0.8	215	0.30	1.2	-	-	-	200	0.30	1.2	-	-	-	-	-	-	40	0.15	0.7
DNMG 110408E-M:T9325	0.8	175	0.30	1.2	-	-	-	165	0.30	1.2	-	-	-	-	-	-	-	-	-
DNMG 110408E-M:T9335	0.8	155	0.30	1.2	-	-	-	-	-	-	-	-	-	-	-	-	-	-	-
DNMG 110408E-M:T9415	0.8	235	0.30	1.2	-	-	-	220	0.30	1.2	-	-	-	-	-	-	45	0.15	0.7
DNMG 110412E-M:T9325	1.2	165	0.40	1.2	-	-	-	155	0.40	1.2	-	-	-	-	-	-	-	-	-
DNMG 110412E-M:T9415	1.2	220	0.40	1.2	-	-	-	205	0.40	1.2	-	-	-	-	-	-	40	0.20	0.9
DNMG 150404E-M:T5315	0.4	200	0.20	1.9	-	-	-	190	0.20	1.9	-	-	-	-	-	-	40	0.14	0.3
DNMG 150404E-M:T9325	0.4	170	0.20	1.9	-	-	-	160	0.20	1.9	-	-	-	-	-	-	-	-	-
DNMG 150404E-M:T9415	0.4	210	0.20	1.9	-	-	-	195	0.20	1.9	-	-	-	-	-	-	40	0.14	0.3
DNMG 150408E-M:T5315	0.8	205	0.30	1.9	-	-	-	190	0.30	1.9	-	-	-	-	-	-	40	0.15	0.7
DNMG 150408E-M:T9315	0.8	190	0.30	1.9	-	-	-	180	0.30	1.9	-	-	-	-	-	-	35	0.15	0.7
DNMG 150408E-M:T9325	0.8	170	0.30	1.9	-	-	-	160	0.30	1.9	-	-	-	-	-	-	-	-	-
DNMG 150408E-M:T9335	0.8	145	0.30	1.9	-	-	-	-	-	-	-	-	-	-	-	-	-	-	-
DNMG 150408E-M:T9415	0.8	220	0.30	1.9	-	-	-	205	0.30	1.9	-	-	-	-	-	-	40	0.15	0.7
DNMG 150412E-M:T5315	1.2	200	0.40	1.9	-	-	-	190	0.40	1.9	-	-	-	-	-	-	40	0.20	0.9
DNMG 150412E-M:T9315	1.2	175	0.40	1.9	-	-	-	165	0.40	1.9	-	-	-	-	-	-	35	0.20	0.9
DNMG 150412E-M:T9325	1.2	160	0.40	1.9	-	-	-	150	0.40	1.9	-	-	-	-	-	-	-	-	-
DNMG 150412E-M:T9415	1.2	210	0.40	1.9	-	-	-	195	0.40	1.9	-	-	-	-	-	-	40	0.20	0.9
DNMG 150604E-M:T5315	0.4	200	0.20	1.9	-	-	-	190	0.20	1.9	-	-	-	-	-	-	40	0.14	0.3
DNMG 150604E-M:T9325	0.4	170	0.20	1.9	-	-	-	160	0.20	1.9	-	-	-	-	-	-	-	-	-
DNMG 150604E-M:T9335	0.4	145	0.20	1.9	-	-	-	-	-	-	-	-	-	-	-	-	-	-	-
DNMG 150604E-M:T9415	0.4	210	0.20	1.9	-	-	-	195	0.20	1.9	-	-	-	-	-	-	40	0.14	0.3
DNMG 150608E-M:T5315	0.8	205	0.30	1.9	-	-	-	190	0.30	1.9	-	-	-	-	-	-	40	0.15	0.7
DNMG 150608E-M:T9310	0.8	205	0.30	1.9	-	-	-	190	0.30	1.9	-	-	-	-	-	-	40	0.15	0.7
DNMG 150608E-M:T9315	0.8	190	0.30	1.9	-	-	-	180	0.30	1.9	-	-	-	-	-	-	35	0.15	0.7
DNMG 150608E-M:T9325	0.8	170	0.30	1.9	-	-	-	160	0.30	1.9	-	-	-	-	-	-	-	-	-
DNMG 150608E-M:T9335	0.8	145	0.30	1.9	-	-	-	-	-	-	-	-	-	-	-	-	-	-	-
DNMG 150608E-M:T9415	0.8	220	0.30	1.9	-	-	-	205	0.30	1.9	-	-	-	-	-	-	40	0.15	0.7
DNMG 150612E-M:T5315	1.2	200	0.40	1.9	-	-	-	190	0.40	1.9	-	-	-	-	-	-	40	0.20	0.9
DNMG 150612E-M:T9310	1.2	190	0.40	1.9	-	-	-	180	0.40	1.9	-	-	-	-	-	-	35	0.20	0.9
DNMG 150612E-M:T9315	1.2	175	0.40	1.9	-	-	-	165	0.40	1.9	-	-	-	-	-	-	35	0.20	0.9
DNMG 150612E-M:T9325	1.2	160	0.40	1.9	-	-	-	150	0.40	1.9	-	-	-	-	-	-	-	-	-
DNMG 150612E-M:T9335	1.2	140	0.40	1.9	-	-	-	-	-	-	-	-	-	-	-	-	-	-	-
DNMG 150612E-M:T9415	1.2	210	0.40	1.9	-	-	-	195	0.40	1.9	-	-	-	-	-	-	40	0.20	0.9

Suitability and starting values for cutting speed (vc), feed (f) and depth of cut (ap). Refer to our Machining Calculator app for further calculations.

Product	RE (mm)	P			M			K			N			S			H		
		vc (m/min)	f (mm/rev)	ap (mm)	vc (m/min)	f (mm/rev)	ap (mm)	vc (m/min)	f (mm/rev)	ap (mm)	vc (m/min)	f (mm/rev)	ap (mm)	vc (m/min)	f (mm/rev)	ap (mm)	vc (m/min)	f (mm/rev)	ap (mm)

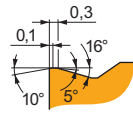
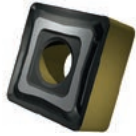

M chip breaker is versatile and the first choice for medium machining of Cast irons. It features positive rake angle and negative/stable, moderate T-land. It's also suitable for Steels, and conditionally for Hard materials.

SNMG 120408E-M:T5305	0.8	290	0.32	2.1	—	—	—	275	0.32	2.1	—	—	—	—	—	—	55	0.16	0.7
SNMG 120408E-M:T5315	0.8	260	0.32	2.1	—	—	—	245	0.32	2.1	—	—	—	—	—	—	50	0.16	0.7
SNMG 120408E-M:T9325	0.8	210	0.32	2.1	—	—	—	195	0.32	2.1	—	—	—	—	—	—	—	—	—
SNMG 120408E-M:T9335	0.8	185	0.32	2.1	—	—	—	—	—	—	—	—	—	—	—	—	—	—	—
SNMG 120408E-M:T9415	0.8	280	0.32	2.1	—	—	—	265	0.32	2.1	—	—	—	—	—	—	55	0.16	0.7
SNMG 120412E-M:T9325	1.2	200	0.40	2.1	—	—	—	190	0.40	2.1	—	—	—	—	—	—	—	—	—
SNMG 120412E-M:T9335	1.2	175	0.40	2.1	—	—	—	—	—	—	—	—	—	—	—	—	—	—	—
SNMG 120412E-M:T9415	1.2	275	0.40	2.1	—	—	—	260	0.40	2.1	—	—	—	—	—	—	55	0.20	1.0
SNMG 120416E-M:T9325	1.6	210	0.40	2.1	—	—	—	195	0.40	2.1	—	—	—	—	—	—	—	—	—
SNMG 150612E-M:T9325	1.2	195	0.40	3.4	—	—	—	185	0.40	3.4	—	—	—	—	—	—	—	—	—
SNMG 150612E-M:T9335	1.2	170	0.40	3.4	—	—	—	—	—	—	—	—	—	—	—	—	—	—	—
SNMG 150612E-M:T9415	1.2	260	0.40	3.4	—	—	—	245	0.40	3.4	—	—	—	—	—	—	50	0.20	1.0
SNMG 190612E-M:6630	1.2	175	0.40	4.0	—	—	—	165	0.40	4.0	—	—	—	—	—	—	—	—	—
SNMG 190612E-M:T9325	1.2	190	0.40	4.0	—	—	—	180	0.40	4.0	—	—	—	—	—	—	—	—	—
SNMG 190612E-M:T9335	1.2	165	0.40	4.0	—	—	—	—	—	—	—	—	—	—	—	—	—	—	—
SNMG 190612E-M:T9415	1.2	255	0.40	4.0	—	—	—	240	0.40	4.0	—	—	—	—	—	—	50	0.20	1.0
SNMG 190616E-M:T9325	1.6	200	0.40	4.0	—	—	—	190	0.40	4.0	—	—	—	—	—	—	—	—	—
SNMG 190616E-M:T9335	1.6	175	0.40	4.0	—	—	—	—	—	—	—	—	—	—	—	—	—	—	—
SNMG 190616E-M:T9415	1.6	270	0.40	4.0	—	—	—	255	0.40	4.0	—	—	—	—	—	—	50	0.20	1.3

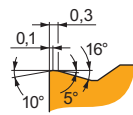
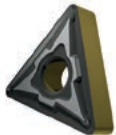

M chip breaker is versatile and the first choice for medium machining of Cast irons. It features positive rake angle and negative/stable, moderate T-land. It's also suitable for Steels, and conditionally for Hard materials.

TNMG 160404E-M:T5315	0.4	215	0.20	1.6	—	—	—	200	0.20	1.6	—	—	—	—	—	—	40	0.14	0.3
TNMG 160404E-M:T9325	0.4	180	0.20	1.6	—	—	—	170	0.20	1.6	—	—	—	—	—	—	—	—	—
TNMG 160404E-M:T9335	0.4	155	0.20	1.6	—	—	—	—	—	—	—	—	—	—	—	—	—	—	—
TNMG 160404E-M:T9415	0.4	230	0.20	1.6	—	—	—	215	0.20	1.6	—	—	—	—	—	—	45	0.14	0.3
TNMG 160408E-M:T5305	0.8	250	0.30	1.6	—	—	—	235	0.30	1.6	—	—	—	—	—	—	50	0.15	0.7
TNMG 160408E-M:T5315	0.8	225	0.30	1.6	—	—	—	210	0.30	1.6	—	—	—	—	—	—	45	0.15	0.7
TNMG 160408E-M:T9310	0.8	220	0.30	1.6	—	—	—	205	0.30	1.6	—	—	—	—	—	—	40	0.15	0.7
TNMG 160408E-M:T9325	0.8	185	0.30	1.6	—	—	—	175	0.30	1.6	—	—	—	—	—	—	—	—	—
TNMG 160408E-M:T9335	0.8	160	0.30	1.6	—	—	—	—	—	—	—	—	—	—	—	—	—	—	—
TNMG 160408E-M:T9415	0.8	240	0.30	1.6	—	—	—	225	0.30	1.6	—	—	—	—	—	—	45	0.15	0.7
TNMG 160412E-M:T5315	1.2	215	0.40	1.6	—	—	—	200	0.40	1.6	—	—	—	—	—	—	40	0.20	0.9
TNMG 160412E-M:T9325	1.2	170	0.40	1.6	—	—	—	160	0.40	1.6	—	—	—	—	—	—	—	—	—
TNMG 160412E-M:T9335	1.2	145	0.40	1.6	—	—	—	—	—	—	—	—	—	—	—	—	—	—	—
TNMG 160412E-M:T9415	1.2	225	0.40	1.6	—	—	—	210	0.40	1.6	—	—	—	—	—	—	45	0.20	0.9
TNMG 220408E-M:T5315	0.8	215	0.30	2.1	—	—	—	200	0.30	2.1	—	—	—	—	—	—	40	0.15	0.7
TNMG 220408E-M:T9325	0.8	180	0.30	2.1	—	—	—	170	0.30	2.1	—	—	—	—	—	—	—	—	—
TNMG 220408E-M:T9335	0.8	155	0.30	2.1	—	—	—	—	—	—	—	—	—	—	—	—	—	—	—
TNMG 220408E-M:T9415	0.8	230	0.30	2.1	—	—	—	215	0.30	2.1	—	—	—	—	—	—	45	0.15	0.7
TNMG 220412E-M:T5315	1.2	205	0.40	2.1	—	—	—	190	0.40	2.1	—	—	—	—	—	—	40	0.20	0.9
TNMG 220412E-M:T9325	1.2	165	0.40	2.1	—	—	—	155	0.40	2.1	—	—	—	—	—	—	—	—	—
TNMG 220412E-M:T9335	1.2	140	0.40	2.1	—	—	—	—	—	—	—	—	—	—	—	—	—	—	—
TNMG 220412E-M:T9415	1.2	225	0.40	2.1	—	—	—	210	0.40	2.1	—	—	—	—	—	—	45	0.20	0.9

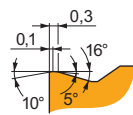

M chip breaker is versatile and the first choice for medium machining of Cast irons. It features positive rake angle and negative/stable, moderate T-land. It's also suitable for Steels, and conditionally for Hard materials.

VNMG 160404E-M:T5315	0.4	180	0.20	1.2	—	—	—	170	0.20	1.2	—	—	—	—	—	—	35	0.14	0.3
VNMG 160404E-M:T9325	0.4	155	0.20	1.2	—	—	—	145	0.20	1.2	—	—	—	—	—	—	—	—	—
VNMG 160404E-M:T9415	0.4	195	0.20	1.2	—	—	—	185	0.20	1.2	—	—	—	—	—	—	35	0.14	0.3
VNMG 160408E-M:T5305	0.8	205	0.30	1.4	—	—	—	190	0.30	1.4	—	—	—	—	—	—	40	0.15	0.7
VNMG 160408E-M:T5315	0.8	185	0.30	1.4	—	—	—	175	0.30	1.4	—	—	—	—	—	—	35	0.15	0.7
VNMG 160408E-M:T9325	0.8	150	0.30	1.4	—	—	—	140	0.30	1.4	—	—	—	—	—	—	—	—	—
VNMG 160408E-M:T9335	0.8	130	0.30	1.4	—	—	—	—	—	—	—	—	—	—	—	—	—	—	—
VNMG 160408E-M:T9415	0.8	200	0.30	1.4	—	—	—	190	0.30	1.4	—	—	—	—	—	—	40	0.15	0.7
VNMG 160412E-M:T9325	1.2	140	0.40	1.4	—	—	—	130	0.40	1.4	—	—	—	—	—	—	—	—	—

Suitability and starting values for cutting speed (vc), feed (f) and depth of cut (ap). Refer to our Machining Calculator app for further calculations.

Product	RE (mm)	P			M			K			N			S			H		
		vc (m/min)	f (mm/rev)	ap (mm)	vc (m/min)	f (mm/rev)	ap (mm)	vc (m/min)	f (mm/rev)	ap (mm)	vc (m/min)	f (mm/rev)	ap (mm)	vc (m/min)	f (mm/rev)	ap (mm)	vc (m/min)	f (mm/rev)	ap (mm)

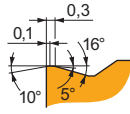
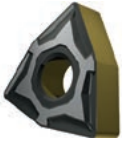

M chip breaker is versatile and the first choice for medium machining of Cast irons. It features positive rake angle and negative/stable, moderate T-land. It's also suitable for Steels, and conditionally for Hard materials.

WNMG 060404E-M:T5315	0.4	250	0.20	1.8	-	-	-	235	0.20	1.8	-	-	-	-	-	-	50	0.13	0.3
WNMG 060404E-M:T9325	0.4	215	0.20	1.8	-	-	-	200	0.20	1.8	-	-	-	-	-	-	-	-	-
WNMG 060404E-M:T9415	0.8	270	0.20	1.8	-	-	-	255	0.20	1.8	-	-	-	-	-	-	50	0.13	0.3
WNMG 060408E-M:T5315	0.4	255	0.32	1.8	-	-	-	240	0.32	1.8	-	-	-	-	-	-	50	0.16	0.7
WNMG 060408E-M:T9325	0.8	205	0.32	1.8	-	-	-	190	0.32	1.8	-	-	-	-	-	-	-	-	-
WNMG 060408E-M:T9335	0.8	180	0.32	1.8	-	-	-	-	-	-	-	-	-	-	-	-	-	-	-
WNMG 060408E-M:T9415	0.8	275	0.32	1.8	-	-	-	260	0.32	1.8	-	-	-	-	-	-	55	0.16	0.7
WNMG 080404E-M:T5315	0.4	260	0.20	1.2	-	-	-	245	0.20	1.2	-	-	-	-	-	-	50	0.13	0.3
WNMG 080404E-M:T9325	0.4	210	0.20	2.1	-	-	-	195	0.20	2.1	-	-	-	-	-	-	-	-	-
WNMG 080404E-M:T9335	0.4	180	0.20	2.1	-	-	-	-	-	-	-	-	-	-	-	-	-	-	-
WNMG 080404E-M:T9415	0.4	265	0.20	2.1	-	-	-	250	0.20	2.1	-	-	-	-	-	-	50	0.13	0.3
WNMG 080408E-M:T5305	0.8	280	0.32	2.1	-	-	-	265	0.32	2.1	-	-	-	-	-	-	55	0.16	0.7
WNMG 080408E-M:T5315	0.8	250	0.32	2.1	-	-	-	235	0.32	2.1	-	-	-	-	-	-	50	0.16	0.7
WNMG 080408E-M:T8430	0.8	170	0.32	2.1	-	-	-	135	0.32	2.1	-	-	-	-	-	-	25	0.16	0.7
WNMG 080408E-M:T9310	0.8	245	0.32	2.1	-	-	-	230	0.32	2.1	-	-	-	-	-	-	45	0.16	0.7
WNMG 080408E-M:T9315	0.8	225	0.32	2.1	-	-	-	210	0.32	2.1	-	-	-	-	-	-	45	0.16	0.7
WNMG 080408E-M:T9325	0.8	200	0.32	2.1	-	-	-	190	0.32	2.1	-	-	-	-	-	-	-	-	-
WNMG 080408E-M:T9335	0.8	180	0.32	2.1	-	-	-	-	-	-	-	-	-	-	-	-	-	-	-
WNMG 080408E-M:T9415	0.8	270	0.32	2.1	-	-	-	255	0.32	2.1	-	-	-	-	-	-	50	0.16	0.7
WNMG 080412E-M:T5305	1.2	275	0.40	2.1	-	-	-	260	0.40	2.1	-	-	-	-	-	-	55	0.20	1.0
WNMG 080412E-M:T5315	1.2	245	0.40	2.1	-	-	-	230	0.40	2.1	-	-	-	-	-	-	45	0.20	1.0
WNMG 080412E-M:T9310	1.2	235	0.40	2.1	-	-	-	220	0.40	2.1	-	-	-	-	-	-	45	0.20	1.0
WNMG 080412E-M:T9315	1.2	220	0.40	2.1	-	-	-	205	0.40	2.1	-	-	-	-	-	-	40	0.20	1.0
WNMG 080412E-M:T9325	1.2	195	0.40	2.1	-	-	-	185	0.40	2.1	-	-	-	-	-	-	-	-	-
WNMG 080412E-M:T9335	1.2	170	0.40	2.1	-	-	-	-	-	-	-	-	-	-	-	-	-	-	-
WNMG 080412E-M:T9415	1.2	265	0.40	2.1	-	-	-	250	0.40	2.1	-	-	-	-	-	-	50	0.20	1.0

SI

SI chip breaker is sharp and designed for medium machining of Steels, Stainless steels. It features positive rake angle without T-land. It's also conditionally suitable for Non-ferrous alloys and Super-alloys.

PRAMET

CNMG

	IC	D1	L	S
	(mm)	(mm)	(mm)	(mm)
1204	12.700	5.16	12.90	4.76

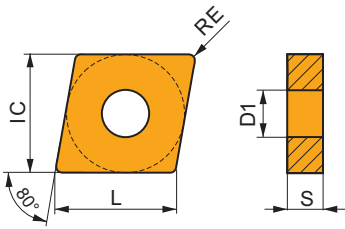

DNMG

	IC	D1	L	S
	(mm)	(mm)	(mm)	(mm)
1104	9.525	3.81	11.60	4.76
1504	12.700	5.16	15.50	4.76
1506	12.700	5.16	15.50	6.35

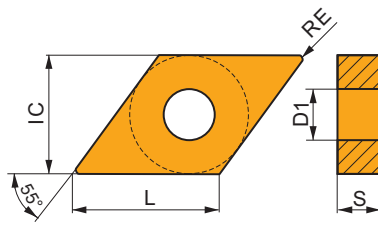

TNMG

	IC	D1	L	S
	(mm)	(mm)	(mm)	(mm)
1604	9.525	3.81	16.50	4.76

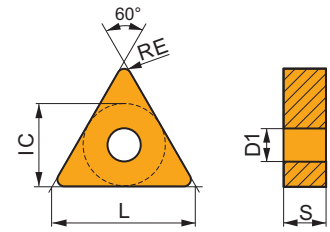

WNMG

	IC	D1	L	S
	(mm)	(mm)	(mm)	(mm)
0604	9.525	3.81	6.50	4.76
0804	12.700	5.16	8.70	4.76

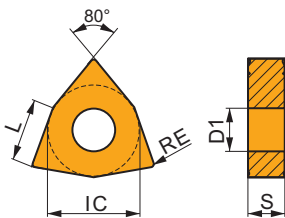

Suitability and starting values for cutting speed (vc), feed (f) and depth of cut (ap). Refer to our Machining Calculator app for further calculations.

Product	RE (mm)	P			M			K			N			S			H		
		vc (m/min)	f (mm/rev)	ap (mm)	vc (m/min)	f (mm/rev)	ap (mm)	vc (m/min)	f (mm/rev)	ap (mm)	vc (m/min)	f (mm/rev)	ap (mm)	vc (m/min)	f (mm/rev)	ap (mm)	vc (m/min)	f (mm/rev)	ap (mm)

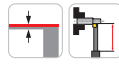
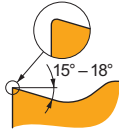
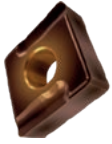

SI chip breaker is sharp and designed for medium machining of Steels, Stainless steels. It features positive rake angle without T-land. It's also conditionally suitable for Non-ferrous alloys and Super-alloys.

CNMG 120404ER-SI:T7335	● 0.4	✓ 215	0.20	1.7	■ 165	0.18	1.7	—	—	—	—	—	—	—	—	—	—	—	—
CNMG 120404ER-SI:T8430	● 0.4	■ 225	0.20	1.7	■ 120	0.18	1.7	—	—	—	✓ 615	0.24	1.7	✓ 45	0.18	1.4	—	—	—
CNMG 120404ER-SI:T9325	● 0.4	■ 270	0.20	1.7	■ 160	0.18	1.7	—	—	—	—	—	—	✓ 60	0.18	1.4	—	—	—
CNMG 120408ER-SI:T7325	● 0.8	✓ 215	0.35	1.7	■ 165	0.32	1.7	—	—	—	—	—	—	✓ 65	0.25	1.4	—	—	—
CNMG 120408ER-SI:T7335	● 0.8	✓ 205	0.35	1.7	■ 155	0.32	1.7	—	—	—	—	—	—	✓ 65	0.25	1.4	—	—	—
CNMG 120408ER-SI:T8430	● 0.8	■ 210	0.35	1.7	■ 115	0.32	1.7	—	—	—	✓ 585	0.42	1.7	✓ 45	0.25	1.4	—	—	—
CNMG 120408ER-SI:T9325	● 0.8	■ 255	0.35	1.7	■ 150	0.32	1.7	—	—	—	—	—	—	✓ 55	0.25	1.4	—	—	—
CNMG 120412ER-SI:T8430	● 1.2	■ 225	0.35	1.7	■ 120	0.32	1.7	—	—	—	✓ 615	0.42	1.7	✓ 45	0.25	1.4	—	—	—

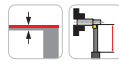
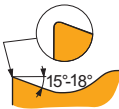
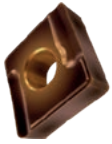

SI chip breaker is sharp and designed for medium machining of Steels, Stainless steels. It features positive rake angle without T-land. It's also conditionally suitable for Non-ferrous alloys and Super-alloys.

CNMG 120404EL-SI:T7335	● 0.4	✓ 215	0.20	1.7	■ 165	0.18	1.7	—	—	—	—	—	—	✓ 65	0.18	1.4	—	—	—
CNMG 120404EL-SI:T8430	● 0.4	■ 225	0.20	1.7	■ 120	0.18	1.7	—	—	—	✓ 615	0.24	1.7	✓ 45	0.18	1.4	—	—	—
CNMG 120404EL-SI:T9325	● 0.4	■ 270	0.20	1.7	■ 160	0.18	1.7	—	—	—	—	—	—	✓ 60	0.18	1.4	—	—	—
CNMG 120408EL-SI:T7325	● 0.8	✓ 215	0.35	1.7	■ 165	0.32	1.7	—	—	—	—	—	—	✓ 65	0.25	1.4	—	—	—
CNMG 120408EL-SI:T7335	● 0.8	✓ 205	0.35	1.7	■ 155	0.32	1.7	—	—	—	—	—	—	✓ 65	0.25	1.4	—	—	—
CNMG 120408EL-SI:T8430	● 0.8	■ 210	0.35	1.7	■ 115	0.32	1.7	—	—	—	✓ 585	0.42	1.7	✓ 45	0.25	1.4	—	—	—
CNMG 120408EL-SI:T9325	● 0.8	■ 255	0.35	1.7	■ 150	0.32	1.7	—	—	—	—	—	—	✓ 55	0.25	1.4	—	—	—
CNMG 120412EL-SI:T8430	● 1.2	■ 225	0.35	1.7	■ 120	0.32	1.7	—	—	—	✓ 615	0.42	1.7	✓ 45	0.25	1.4	—	—	—

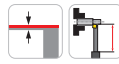
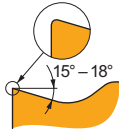
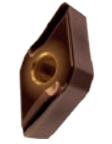

SI chip breaker is sharp and designed for medium machining of Steels, Stainless steels. It features positive rake angle without T-land. It's also conditionally suitable for Non-ferrous alloys and Super-alloys.

DNMG 110404ER-SI:T7325	● 0.4	✓ 185	0.20	1.0	■ 140	0.18	1.0	—	—	—	—	—	—	✓ 60	0.18	0.8	—	—	—
DNMG 110404ER-SI:T7335	● 0.4	✓ 180	0.20	1.0	■ 140	0.18	1.0	—	—	—	—	—	—	✓ 55	0.18	0.8	—	—	—
DNMG 110404ER-SI:T8430	● 0.4	■ 185	0.20	1.0	■ 100	0.18	1.0	—	—	—	✓ 510	0.24	1.0	✓ 40	0.18	0.8	—	—	—
DNMG 110404ER-SI:T9325	● 0.4	■ 225	0.20	1.0	■ 135	0.18	1.0	—	—	—	—	—	—	✓ 50	0.18	0.8	—	—	—
DNMG 110408ER-SI:T7335	● 0.8	✓ 175	0.35	1.0	■ 135	0.32	1.0	—	—	—	—	—	—	✓ 55	0.25	0.8	—	—	—
DNMG 110408ER-SI:T8430	● 0.8	■ 180	0.35	1.0	■ 95	0.32	1.0	—	—	—	✓ 495	0.42	1.0	✓ 35	0.25	0.8	—	—	—
DNMG 110408ER-SI:T9325	● 0.8	■ 210	0.35	1.0	■ 125	0.32	1.0	—	—	—	—	—	—	✓ 45	0.25	0.8	—	—	—
DNMG 150404ER-SI:T8430	● 0.4	■ 175	0.20	1.5	■ 95	0.18	1.5	—	—	—	✓ 480	0.24	1.5	✓ 35	0.18	1.2	—	—	—
DNMG 150404ER-SI:T9325	● 0.4	■ 220	0.20	1.5	■ 130	0.18	1.5	—	—	—	—	—	—	✓ 45	0.18	1.2	—	—	—
DNMG 150408ER-SI:T8430	● 0.8	■ 170	0.35	1.5	■ 90	0.32	1.5	—	—	—	✓ 465	0.42	1.5	✓ 35	0.25	1.2	—	—	—
DNMG 150408ER-SI:T9325	● 0.8	■ 200	0.35	1.5	■ 120	0.32	1.5	—	—	—	—	—	—	✓ 45	0.25	1.2	—	—	—
DNMG 150604ER-SI:T7325	● 0.4	✓ 180	0.20	1.5	■ 140	0.18	1.5	—	—	—	—	—	—	✓ 55	0.18	1.2	—	—	—
DNMG 150604ER-SI:T7335	● 0.4	✓ 170	0.20	1.5	■ 130	0.18	1.5	—	—	—	—	—	—	✓ 55	0.18	1.2	—	—	—
DNMG 150604ER-SI:T8315	● 0.4	✓ 165	0.20	1.5	■ 95	0.18	1.5	—	—	—	✓ 495	0.24	1.5	✓ 40	0.18	1.2	—	—	—
DNMG 150604ER-SI:T8415	● 0.4	■ 195	0.20	1.5	■ 100	0.18	1.5	—	—	—	✓ 495	0.24	1.5	✓ 45	0.18	1.2	—	—	—
DNMG 150604ER-SI:T8430	● 0.4	■ 175	0.20	1.5	■ 95	0.18	1.5	—	—	—	✓ 480	0.24	1.5	✓ 35	0.18	1.2	—	—	—
DNMG 150604ER-SI:T9325	● 0.4	■ 220	0.20	1.5	■ 130	0.18	1.5	—	—	—	—	—	—	✓ 45	0.18	1.2	—	—	—
DNMG 150604ER-SI:T9335	● 0.4	■ 185	0.20	1.5	■ 110	0.18	1.5	—	—	—	—	—	—	✓ 40	0.18	1.2	—	—	—
DNMG 150608ER-SI:T7325	● 0.8	✓ 180	0.35	1.5	■ 140	0.32	1.5	—	—	—	—	—	—	✓ 55	0.25	1.2	—	—	—
DNMG 150608ER-SI:T7335	● 0.8	✓ 170	0.35	1.5	■ 130	0.32	1.5	—	—	—	—	—	—	✓ 55	0.25	1.2	—	—	—
DNMG 150608ER-SI:T8315	● 0.8	✓ 165	0.35	1.5	■ 95	0.32	1.5	—	—	—	✓ 495	0.42	1.5	✓ 40	0.25	1.2	—	—	—
DNMG 150608ER-SI:T8415	● 0.8	■ 200	0.35	1.5	■ 105	0.32	1.5	—	—	—	✓ 510	0.42	1.5	✓ 45	0.24	1.2	—	—	—
DNMG 150608ER-SI:T8430	● 0.8	■ 170	0.35	1.5	■ 90	0.32	1.5	—	—	—	✓ 465	0.42	1.5	✓ 35	0.25	1.2	—	—	—
DNMG 150608ER-SI:T9325	● 0.8	■ 200	0.35	1.5	■ 120	0.32	1.5	—	—	—	—	—	—	✓ 45	0.25	1.2	—	—	—
DNMG 150608ER-SI:T9335	● 0.8	■ 180	0.35	1.5	■ 105	0.32	1.5	—	—	—	—	—	—	✓ 40	0.25	1.2	—	—	—

Suitability and starting values for cutting speed (vc), feed (f) and depth of cut (ap). Refer to our Machining Calculator app for further calculations.

Product	RE (mm)	P			M			K			N			S			H		
		vc (m/min)	f (mm/rev)	ap (mm)	vc (m/min)	f (mm/rev)	ap (mm)	vc (m/min)	f (mm/rev)	ap (mm)	vc (m/min)	f (mm/rev)	ap (mm)	vc (m/min)	f (mm/rev)	ap (mm)	vc (m/min)	f (mm/rev)	ap (mm)

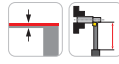
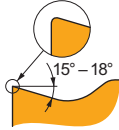
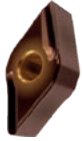

SI chip breaker is sharp and designed for medium machining of Steels, Stainless steels. It features positive rake angle without T-land. It's also conditionally suitable for Non-ferrous alloys and Super-alloys.

DNMG 110404EL-SI:T8430	● 0.4	■ 185	0.20	1.0	■ 100	0.18	1.0	—	—	—	■ 510	0.24	1.0	■ 40	0.18	0.8	—	—	—
DNMG 110404EL-SI:T9325	● 0.4	■ 225	0.20	1.0	■ 135	0.18	1.0	—	—	—	—	—	—	■ 50	0.18	0.8	—	—	—
DNMG 110408EL-SI:T8430	● 0.8	■ 180	0.35	1.0	■ 95	0.32	1.0	—	—	—	■ 495	0.42	1.0	■ 35	0.25	0.8	—	—	—
DNMG 110408EL-SI:T9325	● 0.8	■ 210	0.35	1.0	■ 125	0.32	1.0	—	—	—	—	—	—	■ 45	0.25	0.8	—	—	—
DNMG 150404EL-SI:T8430	● 0.4	■ 175	0.20	1.5	■ 95	0.18	1.5	—	—	—	■ 480	0.24	1.5	■ 35	0.18	1.2	—	—	—
DNMG 150404EL-SI:T9325	● 0.4	■ 220	0.20	1.5	■ 130	0.18	1.5	—	—	—	—	—	—	■ 45	0.18	1.2	—	—	—
DNMG 150408EL-SI:T7335	● 0.8	■ 170	0.35	1.5	■ 130	0.32	1.5	—	—	—	—	—	—	■ 55	0.25	1.2	—	—	—
DNMG 150408EL-SI:T8430	● 0.8	■ 170	0.35	1.5	■ 90	0.32	1.5	—	—	—	■ 465	0.42	1.5	■ 35	0.25	1.2	—	—	—
DNMG 150408EL-SI:T9325	● 0.8	■ 200	0.35	1.5	■ 120	0.32	1.5	—	—	—	—	—	—	■ 45	0.25	1.2	—	—	—
DNMG 150604EL-SI:T7325	● 0.4	■ 180	0.20	1.5	■ 140	0.18	1.5	—	—	—	—	—	—	■ 55	0.18	1.2	—	—	—
DNMG 150604EL-SI:T9325	● 0.4	■ 170	0.20	1.5	■ 130	0.18	1.5	—	—	—	—	—	—	■ 55	0.18	1.2	—	—	—
DNMG 150604EL-SI:T8315	● 0.4	■ 165	0.20	1.5	■ 95	0.18	1.5	—	—	—	■ 495	0.24	1.5	■ 40	0.18	1.2	—	—	—
DNMG 150604EL-SI:T8430	● 0.4	■ 175	0.20	1.5	■ 95	0.18	1.5	—	—	—	■ 480	0.24	1.5	■ 35	0.18	1.2	—	—	—
DNMG 150604EL-SI:T9325	● 0.4	■ 220	0.20	1.5	■ 130	0.18	1.5	—	—	—	—	—	—	■ 45	0.18	1.2	—	—	—
DNMG 150604EL-SI:T9335	● 0.4	■ 185	0.20	1.5	■ 110	0.18	1.5	—	—	—	—	—	—	■ 40	0.18	1.2	—	—	—
DNMG 150608EL-SI:T7325	● 0.8	■ 180	0.35	1.5	■ 140	0.32	1.5	—	—	—	—	—	—	■ 55	0.25	1.2	—	—	—
DNMG 150608EL-SI:T7335	● 0.8	■ 170	0.35	1.5	■ 130	0.32	1.5	—	—	—	—	—	—	■ 55	0.25	1.2	—	—	—
DNMG 150608EL-SI:T8315	● 0.8	■ 165	0.35	1.5	■ 95	0.32	1.5	—	—	—	■ 495	0.42	1.5	■ 40	0.25	1.2	—	—	—
DNMG 150608EL-SI:T8415	● 0.8	■ 200	0.35	1.5	■ 105	0.32	1.5	—	—	—	■ 510	0.42	1.5	■ 45	0.24	1.2	—	—	—
DNMG 150608EL-SI:T8430	● 0.8	■ 170	0.35	1.5	■ 90	0.32	1.5	—	—	—	■ 465	0.42	1.5	■ 35	0.25	1.2	—	—	—
DNMG 150608EL-SI:T9325	● 0.8	■ 200	0.35	1.5	■ 120	0.32	1.5	—	—	—	—	—	—	■ 45	0.25	1.2	—	—	—
DNMG 150608EL-SI:T9335	● 0.8	■ 180	0.35	1.5	■ 105	0.32	1.5	—	—	—	—	—	—	■ 40	0.25	1.2	—	—	—

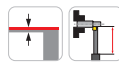
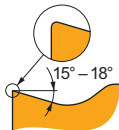
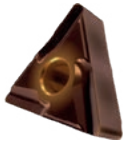

SI chip breaker is sharp and designed for medium machining of Steels, Stainless steels. It features positive rake angle without T-land. It's also conditionally suitable for Non-ferrous alloys and Super-alloys.

TNMG 160404ER-SI:T7325	● 0.4	■ 190	0.20	1.5	■ 145	0.18	1.5	—	—	—	—	—	—	■ 60	0.18	1.2	—	—	—
TNMG 160404ER-SI:T7335	● 0.4	■ 180	0.20	1.5	■ 140	0.18	1.5	—	—	—	—	—	—	■ 55	0.18	1.2	—	—	—
TNMG 160404ER-SI:T8315	● 0.4	■ 175	0.20	1.5	■ 105	0.18	1.5	—	—	—	■ 525	0.24	1.5	■ 40	0.18	1.2	—	—	—
TNMG 160404ER-SI:T8415	● 0.4	■ 210	0.20	1.5	■ 110	0.18	1.5	—	—	—	■ 525	0.24	1.5	■ 45	0.18	1.2	—	—	—
TNMG 160404ER-SI:T8430	● 0.4	■ 185	0.20	1.5	■ 100	0.18	1.5	—	—	—	■ 510	0.24	1.5	■ 40	0.18	1.2	—	—	—
TNMG 160404ER-SI:T9325	● 0.4	■ 230	0.20	1.5	■ 135	0.18	1.5	—	—	—	—	—	—	■ 50	0.18	1.2	—	—	—
TNMG 160404ER-SI:T9335	● 0.4	■ 195	0.20	1.5	■ 115	0.18	1.5	—	—	—	—	—	—	■ 40	0.18	1.2	—	—	—
TNMG 160408ER-SI:T7325	● 0.8	■ 190	0.35	1.5	■ 145	0.32	1.5	—	—	—	—	—	—	■ 60	0.25	1.2	—	—	—
TNMG 160408ER-SI:T7335	● 0.8	■ 180	0.35	1.5	■ 140	0.32	1.5	—	—	—	—	—	—	■ 55	0.25	1.2	—	—	—
TNMG 160408ER-SI:T8315	● 0.8	■ 175	0.35	1.5	■ 105	0.32	1.5	—	—	—	■ 525	0.42	1.5	■ 40	0.25	1.2	—	—	—
TNMG 160408ER-SI:T8415	● 0.8	■ 215	0.35	1.5	■ 110	0.32	1.5	—	—	—	■ 540	0.42	1.5	■ 45	0.24	1.2	—	—	—
TNMG 160408ER-SI:T8430	● 0.8	■ 180	0.35	1.5	■ 95	0.32	1.5	—	—	—	■ 495	0.42	1.5	■ 35	0.25	1.2	—	—	—
TNMG 160408ER-SI:T9325	● 0.8	■ 215	0.35	1.5	■ 125	0.32	1.5	—	—	—	—	—	—	■ 45	0.25	1.2	—	—	—
TNMG 160408ER-SI:T9335	● 0.8	■ 190	0.35	1.5	■ 110	0.32	1.5	—	—	—	—	—	—	■ 40	0.25	1.2	—	—	—

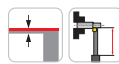
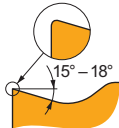
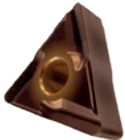

SI chip breaker is sharp and designed for medium machining of Steels, Stainless steels. It features positive rake angle without T-land. It's also conditionally suitable for Non-ferrous alloys and Super-alloys.

TNMG 160404EL-SI:T7325	● 0.4	■ 190	0.20	1.5	■ 145	0.18	1.5	—	—	—	—	—	—	■ 60	0.18	1.2	—	—	—
TNMG 160404EL-SI:T7335	● 0.4	■ 180	0.20	1.5	■ 140	0.18	1.5	—	—	—	—	—	—	■ 55	0.18	1.2	—	—	—
TNMG 160404EL-SI:T8315	● 0.4	■ 175	0.20	1.5	■ 105	0.18	1.5	—	—	—	■ 525	0.24	1.5	■ 40	0.18	1.2	—	—	—
TNMG 160404EL-SI:T8415	● 0.4	■ 210	0.20	1.5	■ 110	0.18	1.5	—	—	—	■ 525	0.24	1.5	■ 45	0.18	1.2	—	—	—
TNMG 160404EL-SI:T8430	● 0.4	■ 185	0.20	1.5	■ 100	0.18	1.5	—	—	—	■ 510	0.24	1.5	■ 40	0.18	1.2	—	—	—
TNMG 160404EL-SI:T9325	● 0.4	■ 230	0.20	1.5	■ 135	0.18	1.5	—	—	—	—	—	—	■ 50	0.18	1.2	—	—	—
TNMG 160404EL-SI:T9335	● 0.4	■ 195	0.20	1.5	■ 115	0.18	1.5	—	—	—	—	—	—	■ 40	0.18	1.2	—	—	—
TNMG 160408EL-SI:T7325	● 0.8	■ 190	0.35	1.5	■ 145	0.32	1.5	—	—	—	—	—	—	■ 60	0.25	1.2	—	—	—
TNMG 160408EL-SI:T7335	● 0.8	■ 180	0.35	1.5	■ 140	0.32	1.5	—	—	—	—	—	—	■ 55	0.25	1.2	—	—	—
TNMG 160408EL-SI:T8315	● 0.8	■ 175	0.35	1.5	■ 105	0.32	1.5	—	—	—	■ 525	0.42	1.5	■ 40	0.25	1.2	—	—	—
TNMG 160408EL-SI:T8415	● 0.8	■ 215	0.35	1.5	■ 110	0.32	1.5	—	—	—	■ 540	0.42	1.5	■ 45	0.24	1.2	—	—	—
TNMG 160408EL-SI:T8430	● 0.8	■ 180	0.35	1.5	■ 95	0.32	1.5	—	—	—	■ 495	0.42	1.5	■ 35	0.25	1.2	—	—	—
TNMG 160408EL-SI:T9325	● 0.8	■ 215	0.35	1.5	■ 125	0.32	1.5	—	—	—	—	—	—	■ 45	0.25	1.2	—	—	—
TNMG 160408EL-SI:T9335	● 0.8	■ 190	0.35	1.5	■ 110	0.32	1.5	—	—	—	—	—	—	■ 40	0.25	1.2	—	—	—

Suitability and starting values for cutting speed (vc), feed (f) and depth of cut (ap). Refer to our Machining Calculator app for further calculations.

Product	RE (mm)	P			M			K			N			S			H		
		vc (m/min)	f (mm/rev)	ap (mm)	vc (m/min)	f (mm/rev)	ap (mm)	vc (m/min)	f (mm/rev)	ap (mm)	vc (m/min)	f (mm/rev)	ap (mm)	vc (m/min)	f (mm/rev)	ap (mm)	vc (m/min)	f (mm/rev)	ap (mm)

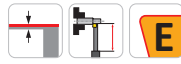
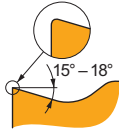

SI chip breaker is sharp and designed for medium machining of Steels, Stainless steels. It features positive rake angle without T-land. It's also conditionally suitable for Non-ferrous alloys and Super-alloys.

WNMG 060404ER-SI-T8430	● 0.4	■ 225	■ 0.20	■ 1.7	■ 120	■ 0.18	■ 1.7	■ -	■ -	■ -	■ 615	■ 0.24	■ 1.7	■ 45	■ 0.18	■ 1.4	■ -	■ -	■ -
WNMG 060404ER-SI-T9325	● 0.4	■ 270	■ 0.20	■ 1.7	■ 160	■ 0.18	■ 1.7	■ -	■ -	■ -	■ -	■ -	■ -	■ 60	■ 0.18	■ 1.4	■ -	■ -	■ -
WNMG 080404ER-SI-T7325	● 0.4	■ 220	■ 0.20	■ 1.7	■ 170	■ 0.18	■ 1.7	■ -	■ -	■ -	■ -	■ -	■ -	■ 70	■ 0.18	■ 1.4	■ -	■ -	■ -
WNMG 080404ER-SI-T7335	● 0.4	■ 215	■ 0.20	■ 1.7	■ 165	■ 0.18	■ 1.7	■ -	■ -	■ -	■ -	■ -	■ -	■ 65	■ 0.18	■ 1.4	■ -	■ -	■ -
WNMG 080404ER-SI-T8315	● 0.4	■ 205	■ 0.20	■ 1.7	■ 120	■ 0.18	■ 1.7	■ -	■ -	■ -	■ 615	■ 0.24	■ 1.7	■ 50	■ 0.18	■ 1.4	■ -	■ -	■ -
WNMG 080404ER-SI-T8415	● 0.4	■ 250	■ 0.20	■ 1.7	■ 130	■ 0.18	■ 1.7	■ -	■ -	■ -	■ 630	■ 0.24	■ 1.7	■ 55	■ 0.18	■ 1.4	■ -	■ -	■ -
WNMG 080404ER-SI-T8430	● 0.4	■ 225	■ 0.20	■ 1.7	■ 120	■ 0.18	■ 1.7	■ -	■ -	■ -	■ 615	■ 0.24	■ 1.7	■ 45	■ 0.18	■ 1.4	■ -	■ -	■ -
WNMG 080404ER-SI-T9325	● 0.4	■ 270	■ 0.20	■ 1.7	■ 160	■ 0.18	■ 1.7	■ -	■ -	■ -	■ -	■ -	■ -	■ 60	■ 0.18	■ 1.4	■ -	■ -	■ -
WNMG 080408ER-SI-T7325	● 0.8	■ 215	■ 0.35	■ 1.7	■ 165	■ 0.32	■ 1.7	■ -	■ -	■ -	■ -	■ -	■ -	■ 65	■ 0.25	■ 1.4	■ -	■ -	■ -
WNMG 080408ER-SI-T7335	● 0.8	■ 205	■ 0.35	■ 1.7	■ 155	■ 0.32	■ 1.7	■ -	■ -	■ -	■ -	■ -	■ -	■ 65	■ 0.25	■ 1.4	■ -	■ -	■ -
WNMG 080408ER-SI-T8315	● 0.8	■ 205	■ 0.35	■ 1.7	■ 120	■ 0.32	■ 1.7	■ -	■ -	■ -	■ 615	■ 0.42	■ 1.7	■ 50	■ 0.25	■ 1.4	■ -	■ -	■ -
WNMG 080408ER-SI-T8430	● 0.8	■ 210	■ 0.35	■ 1.7	■ 115	■ 0.32	■ 1.7	■ -	■ -	■ -	■ 585	■ 0.42	■ 1.7	■ 45	■ 0.25	■ 1.4	■ -	■ -	■ -
WNMG 080408ER-SI-T9325	● 0.8	■ 255	■ 0.35	■ 1.7	■ 150	■ 0.32	■ 1.7	■ -	■ -	■ -	■ -	■ -	■ -	■ 55	■ 0.25	■ 1.4	■ -	■ -	■ -
WNMG 080412ER-SI-T8430	● 1.2	■ 225	■ 0.35	■ 1.7	■ 120	■ 0.32	■ 1.7	■ -	■ -	■ -	■ 615	■ 0.42	■ 1.7	■ 45	■ 0.25	■ 1.4	■ -	■ -	■ -

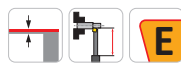
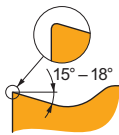
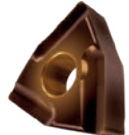

SI chip breaker is sharp and designed for medium machining of Steels, Stainless steels. It features positive rake angle without T-land. It's also conditionally suitable for Non-ferrous alloys and Super-alloys.

WNMG 060404EL-SI-T8430	● 0.4	■ 225	■ 0.20	■ 1.7	■ 120	■ 0.18	■ 1.7	■ -	■ -	■ -	■ 615	■ 0.24	■ 1.7	■ 45	■ 0.18	■ 1.4	■ -	■ -	■ -
WNMG 060404EL-SI-T9325	● 0.4	■ 270	■ 0.20	■ 1.7	■ 160	■ 0.18	■ 1.7	■ -	■ -	■ -	■ -	■ -	■ -	■ 60	■ 0.18	■ 1.4	■ -	■ -	■ -
WNMG 080404EL-SI-T7325	● 0.4	■ 220	■ 0.20	■ 1.7	■ 170	■ 0.18	■ 1.7	■ -	■ -	■ -	■ -	■ -	■ -	■ 70	■ 0.18	■ 1.4	■ -	■ -	■ -
WNMG 080404EL-SI-T7335	● 0.4	■ 215	■ 0.20	■ 1.7	■ 165	■ 0.18	■ 1.7	■ -	■ -	■ -	■ -	■ -	■ -	■ 65	■ 0.18	■ 1.4	■ -	■ -	■ -
WNMG 080404EL-SI-T8315	● 0.4	■ 205	■ 0.20	■ 1.7	■ 120	■ 0.18	■ 1.7	■ -	■ -	■ -	■ 615	■ 0.24	■ 1.7	■ 50	■ 0.18	■ 1.4	■ -	■ -	■ -
WNMG 080404EL-SI-T8415	● 0.4	■ 250	■ 0.20	■ 1.7	■ 130	■ 0.18	■ 1.7	■ -	■ -	■ -	■ 630	■ 0.24	■ 1.7	■ 55	■ 0.18	■ 1.4	■ -	■ -	■ -
WNMG 080404EL-SI-T8430	● 0.4	■ 225	■ 0.20	■ 1.7	■ 120	■ 0.18	■ 1.7	■ -	■ -	■ -	■ 615	■ 0.24	■ 1.7	■ 45	■ 0.18	■ 1.4	■ -	■ -	■ -
WNMG 080404EL-SI-T9325	● 0.4	■ 270	■ 0.20	■ 1.7	■ 160	■ 0.18	■ 1.7	■ -	■ -	■ -	■ -	■ -	■ -	■ 60	■ 0.18	■ 1.4	■ -	■ -	■ -
WNMG 080408EL-SI-T7325	● 0.8	■ 215	■ 0.35	■ 1.7	■ 165	■ 0.32	■ 1.7	■ -	■ -	■ -	■ -	■ -	■ -	■ 65	■ 0.25	■ 1.4	■ -	■ -	■ -
WNMG 080408EL-SI-T7335	● 0.8	■ 205	■ 0.35	■ 1.7	■ 155	■ 0.32	■ 1.7	■ -	■ -	■ -	■ -	■ -	■ -	■ 65	■ 0.25	■ 1.4	■ -	■ -	■ -
WNMG 080408EL-SI-T8315	● 0.8	■ 205	■ 0.35	■ 1.7	■ 120	■ 0.32	■ 1.7	■ -	■ -	■ -	■ 615	■ 0.42	■ 1.7	■ 50	■ 0.25	■ 1.4	■ -	■ -	■ -
WNMG 080408EL-SI-T8430	● 0.8	■ 210	■ 0.35	■ 1.7	■ 115	■ 0.32	■ 1.7	■ -	■ -	■ -	■ 585	■ 0.42	■ 1.7	■ 45	■ 0.25	■ 1.4	■ -	■ -	■ -
WNMG 080408EL-SI-T9325	● 0.8	■ 255	■ 0.35	■ 1.7	■ 150	■ 0.32	■ 1.7	■ -	■ -	■ -	■ -	■ -	■ -	■ 55	■ 0.25	■ 1.4	■ -	■ -	■ -
WNMG 080412EL-SI-T8430	● 1.2	■ 225	■ 0.35	■ 1.7	■ 120	■ 0.32	■ 1.7	■ -	■ -	■ -	■ 615	■ 0.42	■ 1.7	■ 45	■ 0.25	■ 1.4	■ -	■ -	■ -

NMR

NMR chip breaker is versatile and the first choice for medium machining of Stainless steels. It features positive rake angle and positive, wide T-land. It's also suitable for Steels and Super-alloys.

PRAMET

CNMG

	IC	D1	L	S
	(mm)	(mm)	(mm)	(mm)
0903	9.525	3.81	9.70	3.18
1204	12.700	5.16	12.90	4.76
1606	15.875	6.35	16.10	6.35
1906	19.050	7.94	19.30	6.35

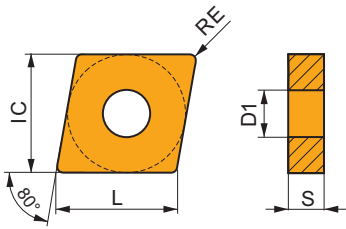

DNMG

	IC	D1	L	S
	(mm)	(mm)	(mm)	(mm)
1104	9.525	3.81	11.60	4.76
1504	12.700	5.16	15.50	4.76
1506	12.700	5.16	15.50	6.35

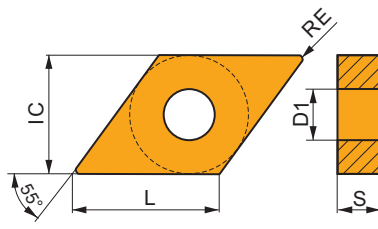

SNMG

	IC	D1	L	S
	(mm)	(mm)	(mm)	(mm)
1204	12.700	5.16	12.70	4.76
1506	15.875	6.35	15.88	6.35
1906	19.050	7.94	19.05	6.35

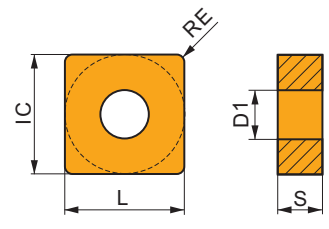

TNMG

	IC	D1	L	S
	(mm)	(mm)	(mm)	(mm)
1604	9.525	3.81	16.50	4.76
2204	12.700	5.16	22.00	4.76

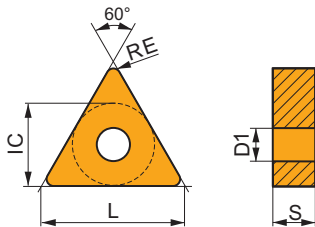

VNMG

	IC	D1	L	S
	(mm)	(mm)	(mm)	(mm)
1604	9.525	3.81	16.60	4.76

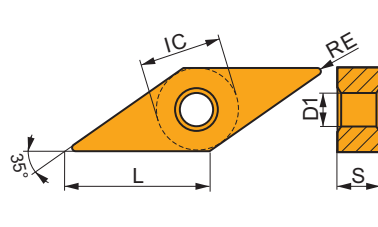

WNMG

	IC	D1	L	S
	(mm)	(mm)	(mm)	(mm)
0604	9.525	3.81	6.50	4.76
0804	12.700	5.16	8.70	4.76

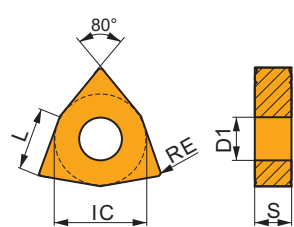

Suitability and starting values for cutting speed (vc), feed (f) and depth of cut (ap). Refer to our Machining Calculator app for further calculations.

Product	Interrupted/ Continuous cut	RE (mm)	P			M			K			N			S			H		
			vc	f	ap	vc	f	ap	vc	f	ap	vc	f	ap	vc	f	ap	vc	f	ap
			(m/min)	(mm/rev)	(mm)	(m/min)	(mm/rev)	(mm)	(m/min)	(mm/rev)	(mm)	(m/min)	(mm/rev)	(mm)	(m/min)	(mm/rev)	(mm)	(m/min)	(mm/rev)	(mm)

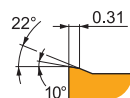

NMR chip breaker is versatile and the first choice for medium machining of Stainless steels. It features positive rake angle and positive, wide T-land. It's also suitable for Steels and Super-alloys.

CNMG 090308E-NMR:T7325	●	0.8	175	0.35	1.6	135	0.32	1.6	-	-	-	-	-	-	55	0.25	1.3	-	-	-
CNMG 090308E-NMR:T7335	●	0.8	170	0.35	1.6	130	0.32	1.6	-	-	-	-	-	-	55	0.25	1.3	-	-	-
CNMG 120404E-NMR:T7325	●	0.4	155	0.25	2.7	120	0.23	2.7	-	-	-	-	-	-	50	0.20	2.2	-	-	-
CNMG 120404E-NMR:T7335	●	0.4	155	0.25	2.0	120	0.23	2.0	-	-	-	-	-	-	50	0.20	1.6	-	-	-
CNMG 120404E-NMR:T8430	●	0.4	150	0.25	2.7	80	0.23	2.7	-	-	-	-	-	30	0.20	2.2	-	-	-	
CNMG 120404E-NMR:T9325	●	0.4	190	0.25	2.0	110	0.23	2.0	-	-	-	-	-	40	0.20	1.6	-	-	-	
CNMG 120404E-NMR:T9415	●	0.4	245	0.25	2.0	-	-	-	-	-	-	-	-	-	-	-	-	-	-	-

Suitability and starting values for cutting speed (vc), feed (f) and depth of cut (ap). Refer to our Machining Calculator app for further calculations.

Product	RE (mm)	P			M			K			N			S			H		
		vc (m/min)	f (mm/rev)	ap (mm)	vc (m/min)	f (mm/rev)	ap (mm)	vc (m/min)	f (mm/rev)	ap (mm)	vc (m/min)	f (mm/rev)	ap (mm)	vc (m/min)	f (mm/rev)	ap (mm)	vc (m/min)	f (mm/rev)	ap (mm)

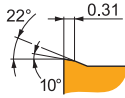

NMR chip breaker is versatile and the first choice for medium machining of Stainless steels. It features positive rake angle and positive, wide T-land. It's also suitable for Steels and Super-alloys.

CNMG 120408E-NMR:T6310	0.8	150	0.35	2.7	105	0.32	2.7	-	-	-	-	-	45	0.25	2.2	-	-	-
CNMG 120408E-NMR:T7325	0.8	170	0.35	2.7	130	0.32	2.7	-	-	-	-	-	55	0.25	2.2	-	-	-
CNMG 120408E-NMR:T7335	0.8	160	0.35	2.7	120	0.32	2.7	-	-	-	-	-	50	0.25	2.2	-	-	-
CNMG 120408E-NMR:T8430	0.8	155	0.35	2.7	85	0.32	2.7	-	-	-	-	-	30	0.25	2.2	-	-	-
CNMG 120408E-NMR:T9325	0.8	190	0.35	2.7	110	0.32	2.7	-	-	-	-	-	40	0.25	2.2	-	-	-
CNMG 120408E-NMR:T9415	0.8	255	0.35	2.7	-	-	-	-	-	-	-	-	-	-	-	-	-	-
CNMG 120412E-NMR:T6310	1.2	150	0.40	2.7	105	0.36	2.7	-	-	-	-	-	45	0.28	2.2	-	-	-
CNMG 120412E-NMR:T7325	1.2	170	0.40	2.7	130	0.36	2.7	-	-	-	-	-	55	0.28	2.2	-	-	-
CNMG 120412E-NMR:T7335	1.2	160	0.40	2.7	120	0.36	2.7	-	-	-	-	-	50	0.28	2.2	-	-	-
CNMG 120412E-NMR:T8430	1.2	155	0.40	2.7	85	0.36	2.7	-	-	-	-	-	30	0.28	2.2	-	-	-
CNMG 120412E-NMR:T9325	1.2	190	0.40	2.7	110	0.36	2.7	-	-	-	-	-	40	0.28	2.2	-	-	-
CNMG 120412E-NMR:T9415	1.2	255	0.40	2.7	-	-	-	-	-	-	-	-	-	-	-	-	-	-
CNMG 120416E-NMR:T7325	1.6	170	0.45	2.7	130	0.41	2.7	-	-	-	-	-	55	0.32	2.2	-	-	-
CNMG 120416E-NMR:T7335	1.6	160	0.45	2.7	120	0.41	2.7	-	-	-	-	-	50	0.32	2.2	-	-	-
CNMG 120416E-NMR:T8430	1.6	155	0.45	2.7	85	0.41	2.7	-	-	-	-	-	30	0.32	2.2	-	-	-
CNMG 160608E-NMR:T7325	0.8	160	0.35	4.0	120	0.32	4.0	-	-	-	-	-	50	0.25	3.2	-	-	-
CNMG 160608E-NMR:T7335	0.8	150	0.35	4.0	115	0.32	4.0	-	-	-	-	-	45	0.25	3.2	-	-	-
CNMG 160608E-NMR:T9325	0.8	185	0.35	4.0	110	0.32	4.0	-	-	-	-	-	40	0.25	3.2	-	-	-
CNMG 160608E-NMR:T9415	0.8	245	0.35	4.0	-	-	-	-	-	-	-	-	-	-	-	-	-	-
CNMG 160612E-NMR:T7325	1.2	165	0.40	4.0	125	0.36	4.0	-	-	-	-	-	50	0.28	3.2	-	-	-
CNMG 160612E-NMR:T7335	1.2	155	0.40	4.0	120	0.36	4.0	-	-	-	-	-	50	0.28	3.2	-	-	-
CNMG 160612E-NMR:T8430	1.2	150	0.40	4.0	80	0.36	4.0	-	-	-	-	-	30	0.28	3.2	-	-	-
CNMG 160612E-NMR:T9325	1.2	185	0.40	4.0	110	0.36	4.0	-	-	-	-	-	40	0.28	3.2	-	-	-
CNMG 160612E-NMR:T9415	1.2	245	0.40	4.0	-	-	-	-	-	-	-	-	-	-	-	-	-	-
CNMG 160616E-NMR:T7325	1.6	165	0.45	4.0	125	0.41	4.0	-	-	-	-	-	50	0.32	3.2	-	-	-
CNMG 160616E-NMR:T7335	1.6	155	0.45	4.0	120	0.41	4.0	-	-	-	-	-	50	0.32	3.2	-	-	-
CNMG 160616E-NMR:T8430	1.6	150	0.45	4.0	80	0.41	4.0	-	-	-	-	-	30	0.32	3.2	-	-	-
CNMG 160616E-NMR:T9325	1.6	180	0.45	4.0	105	0.41	4.0	-	-	-	-	-	40	0.32	3.2	-	-	-
CNMG 160616E-NMR:T9415	1.6	240	0.45	6.0	-	-	-	-	-	-	-	-	-	-	-	-	-	-
CNMG 190608E-NMR:T6310	0.8	140	0.35	5.2	100	0.32	5.2	-	-	-	-	-	40	0.25	4.2	-	-	-
CNMG 190608E-NMR:T7325	0.8	155	0.35	5.2	120	0.32	5.2	-	-	-	-	-	50	0.25	4.2	-	-	-
CNMG 190608E-NMR:T7335	0.8	150	0.35	5.2	115	0.32	5.2	-	-	-	-	-	45	0.25	4.2	-	-	-
CNMG 190608E-NMR:T9325	0.8	180	0.35	5.2	105	0.32	5.2	-	-	-	-	-	40	0.25	4.2	-	-	-
CNMG 190608E-NMR:T9415	0.8	225	0.35	8.0	-	-	-	-	-	-	-	-	-	-	-	-	-	-
CNMG 190612E-NMR:T6310	1.2	140	0.40	5.2	100	0.36	5.2	-	-	-	-	-	40	0.28	4.2	-	-	-
CNMG 190612E-NMR:T7325	1.2	160	0.40	5.2	120	0.36	5.2	-	-	-	-	-	50	0.28	4.2	-	-	-
CNMG 190612E-NMR:T7335	1.2	150	0.40	5.2	115	0.36	5.2	-	-	-	-	-	45	0.28	4.2	-	-	-
CNMG 190612E-NMR:T8430	1.2	145	0.40	5.2	80	0.36	5.2	-	-	-	-	-	30	0.28	4.2	-	-	-
CNMG 190612E-NMR:T9325	1.2	180	0.40	5.2	105	0.36	5.2	-	-	-	-	-	40	0.28	4.2	-	-	-
CNMG 190616E-NMR:T7325	1.6	160	0.45	5.2	120	0.41	5.2	-	-	-	-	-	50	0.32	4.2	-	-	-
CNMG 190616E-NMR:T7335	1.6	150	0.45	5.2	115	0.41	5.2	-	-	-	-	-	45	0.32	4.2	-	-	-
CNMG 190616E-NMR:T8430	1.6	145	0.45	5.2	80	0.41	5.2	-	-	-	-	-	30	0.32	4.2	-	-	-
CNMG 190616E-NMR:T9325	1.6	175	0.45	5.2	105	0.41	5.2	-	-	-	-	-	35	0.32	4.2	-	-	-
CNMG 190616E-NMR:T9415	1.6	240	0.45	5.2	-	-	-	-	-	-	-	-	-	-	-	-	-	-

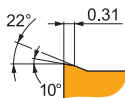
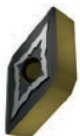

NMR chip breaker is versatile and the first choice for medium machining of Stainless steels. It features positive rake angle and positive, wide T-land. It's also suitable for Steels and Super-alloys.

DNMG 110404E-NMR:T7325	0.4	150	0.20	0.8	115	0.18	0.8	-	-	-	-	-	45	0.18	0.6	-	-	-
DNMG 110404E-NMR:T9325	0.4	185	0.20	0.8	110	0.18	0.8	-	-	-	-	-	40	0.18	0.6	-	-	-
DNMG 110408E-NMR:T7325	0.8	155	0.30	0.8	120	0.27	0.8	-	-	-	-	-	50	0.24	0.6	-	-	-
DNMG 110408E-NMR:T9415	0.8	240	0.30	0.8	-	-	-	-	-	-	-	-	-	-	-	-	-	-
DNMG 110412E-NMR:T7325	1.2	155	0.30	1.6	120	0.27	1.6	-	-	-	-	-	50	0.24	1.3	-	-	-
DNMG 110412E-NMR:T9325	1.2	180	0.30	1.6	105	0.27	1.6	-	-	-	-	-	40	0.24	1.3	-	-	-

Suitability and starting values for cutting speed (vc), feed (f) and depth of cut (ap). Refer to our Machining Calculator app for further calculations.

Product	RE (mm)	P			M			K			N			S			H		
		vc (m/min)	f (mm/rev)	ap (mm)	vc (m/min)	f (mm/rev)	ap (mm)	vc (m/min)	f (mm/rev)	ap (mm)	vc (m/min)	f (mm/rev)	ap (mm)	vc (m/min)	f (mm/rev)	ap (mm)	vc (m/min)	f (mm/rev)	ap (mm)

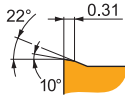

NMR chip breaker is versatile and the first choice for medium machining of Stainless steels. It features positive rake angle and positive, wide T-land. It's also suitable for Steels and Super-alloys.

DNMG 150404E-NMR:T7325	● 0.4	✓	140	0.20	1.9	■	105	0.18	1.9	—	—	—	—	—	—	■	45	0.18	1.5	—	—	—
DNMG 150404E-NMR:T9325	● 0.4	■	170	0.20	1.9	■	100	0.18	1.9	—	—	—	—	—	—	■	35	0.18	1.5	—	—	—
DNMG 150408E-NMR:T7325	● 0.8	✓	145	0.30	1.9	■	110	0.27	1.9	—	—	—	—	—	—	■	45	0.24	1.5	—	—	—
DNMG 150408E-NMR:T8430	● 0.8	■	135	0.30	1.9	■	75	0.27	1.9	—	—	—	—	—	—	■	25	0.24	1.5	—	—	—
DNMG 150408E-NMR:T9325	● 0.8	■	170	0.30	1.9	■	100	0.27	1.9	—	—	—	—	—	—	■	35	0.24	1.5	—	—	—
DNMG 150408E-NMR:T9415	● 0.8	■	220	0.30	1.9	—	—	—	—	—	—	—	—	—	—	—	—	—	—	—	—	—
DNMG 150604E-NMR:T7325	● 0.4	✓	140	0.20	1.9	■	105	0.18	1.9	—	—	—	—	—	—	■	45	0.18	1.5	—	—	—
DNMG 150604E-NMR:T7335	● 0.4	✓	130	0.20	1.9	■	100	0.18	1.9	—	—	—	—	—	—	■	40	0.18	1.5	—	—	—
DNMG 150604E-NMR:T8430	● 0.4	■	135	0.20	1.9	■	75	0.18	1.9	—	—	—	—	—	—	■	25	0.18	1.5	—	—	—
DNMG 150604E-NMR:T9325	● 0.4	■	170	0.20	1.9	■	100	0.18	1.9	—	—	—	—	—	—	■	35	0.18	1.5	—	—	—
DNMG 150604E-NMR:T9415	● 0.4	■	210	0.20	1.9	—	—	—	—	—	—	—	—	—	—	—	—	—	—	—	—	—
DNMG 150608E-NMR:T6310	● 0.8	■	125	0.30	1.9	■	90	0.27	1.9	—	—	—	—	—	—	■	35	0.24	1.5	—	—	—
DNMG 150608E-NMR:T7325	● 0.8	✓	145	0.30	1.9	■	110	0.27	1.9	—	—	—	—	—	—	■	45	0.24	1.5	—	—	—
DNMG 150608E-NMR:T7335	● 0.8	✓	140	0.30	1.9	■	105	0.27	1.9	—	—	—	—	—	—	■	45	0.24	1.5	—	—	—
DNMG 150608E-NMR:T8430	● 0.8	■	135	0.30	1.9	■	75	0.27	1.9	—	—	—	—	—	—	■	25	0.24	1.5	—	—	—
DNMG 150608E-NMR:T9325	● 0.8	■	170	0.30	1.9	■	100	0.27	1.9	—	—	—	—	—	—	■	35	0.24	1.5	—	—	—
DNMG 150608E-NMR:T9415	● 0.8	■	220	0.30	1.9	—	—	—	—	—	—	—	—	—	—	—	—	—	—	—	—	—
DNMG 150612E-NMR:T7325	● 1.2	✓	155	0.30	1.9	■	120	0.27	1.9	—	—	—	—	—	—	■	50	0.24	1.5	—	—	—
DNMG 150612E-NMR:T8430	● 1.2	■	145	0.30	1.9	■	80	0.27	1.9	—	—	—	—	—	—	■	30	0.24	1.5	—	—	—
DNMG 150612E-NMR:T9325	● 1.2	■	180	0.30	1.9	■	105	0.27	1.9	—	—	—	—	—	—	■	40	0.24	1.5	—	—	—
DNMG 150612E-NMR:T9415	● 1.2	■	235	0.30	1.9	—	—	—	—	—	—	—	—	—	—	—	—	—	—	—	—	—

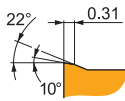

NMR chip breaker is versatile and the first choice for medium machining of Stainless steels. It features positive rake angle and positive, wide T-land. It's also suitable for Steels and Super-alloys.

SNMG 120408E-NMR:T7325	● 0.8	✓	175	0.35	2.6	■	135	0.32	2.6	—	—	—	—	—	—	■	55	0.25	2.1	—	—	—
SNMG 120408E-NMR:T7335	● 0.8	✓	165	0.35	2.6	■	125	0.32	2.6	—	—	—	—	—	—	■	50	0.25	2.1	—	—	—
SNMG 120408E-NMR:T8430	● 0.8	■	165	0.35	2.6	■	90	0.32	2.6	—	—	—	—	—	—	■	35	0.25	2.1	—	—	—
SNMG 120408E-NMR:T9325	● 0.8	■	200	0.35	2.6	■	120	0.32	2.6	—	—	—	—	—	—	■	45	0.25	2.1	—	—	—
SNMG 120412E-NMR:T6310	● 1.2	■	160	0.40	2.6	■	115	0.36	2.6	—	—	—	—	—	—	■	45	0.28	2.1	—	—	—
SNMG 120412E-NMR:T7335	● 1.2	✓	165	0.40	2.6	■	125	0.36	2.6	—	—	—	—	—	—	■	50	0.28	2.1	—	—	—
SNMG 120412E-NMR:T9325	● 1.2	■	200	0.40	2.6	■	120	0.36	2.6	—	—	—	—	—	—	■	45	0.28	2.1	—	—	—
SNMG 120416E-NMR:T7325	● 1.6	✓	180	0.45	2.6	■	140	0.41	2.6	—	—	—	—	—	—	■	55	0.32	2.1	—	—	—
SNMG 150612E-NMR:T6310	● 1.2	■	150	0.40	3.8	■	105	0.36	3.8	—	—	—	—	—	—	■	45	0.28	3.0	—	—	—
SNMG 150612E-NMR:T7325	● 1.2	✓	170	0.40	3.8	■	130	0.36	3.8	—	—	—	—	—	—	■	55	0.28	3.0	—	—	—
SNMG 150612E-NMR:T8430	● 1.2	■	155	0.40	3.8	■	85	0.36	3.8	—	—	—	—	—	—	■	30	0.28	3.0	—	—	—
SNMG 150612E-NMR:T9325	● 1.2	■	190	0.40	3.8	■	110	0.36	3.8	—	—	—	—	—	—	■	40	0.28	3.0	—	—	—
SNMG 190612E-NMR:T6310	● 1.2	■	145	0.40	5.2	■	100	0.36	5.2	—	—	—	—	—	—	■	40	0.28	4.2	—	—	—
SNMG 190612E-NMR:T7325	● 1.2	✓	165	0.40	5.2	■	125	0.36	5.2	—	—	—	—	—	—	■	50	0.28	4.2	—	—	—
SNMG 190612E-NMR:T7335	● 1.2	✓	155	0.40	5.2	■	120	0.36	5.2	—	—	—	—	—	—	■	50	0.28	4.2	—	—	—
SNMG 190612E-NMR:T9325	● 1.2	■	185	0.40	5.2	■	110	0.36	5.2	—	—	—	—	—	—	■	40	0.28	4.2	—	—	—
SNMG 190616E-NMR:T6310	● 1.6	■	150	0.45	5.2	■	105	0.41	5.2	—	—	—	—	—	—	■	45	0.32	4.2	—	—	—
SNMG 190616E-NMR:T7325	● 1.6	✓	170	0.45	5.2	■	130	0.41	5.2	—	—	—	—	—	—	■	55	0.32	4.2	—	—	—
SNMG 190616E-NMR:T7335	● 1.6	✓	155	0.45	5.2	■	120	0.41	5.2	—	—	—	—	—	—	■	50	0.32	4.2	—	—	—
SNMG 190616E-NMR:T8430	● 1.6	■	150	0.45	5.2	■	80	0.41	5.2	—	—	—	—	—	—	■	30	0.32	4.2	—	—	—
SNMG 190616E-NMR:T9415	● 1.6	■	250	0.45	5.2	—	—	—	—	—	—	—	—	—	—	—	—	—	—	—	—	—

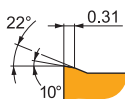
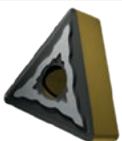

NMR chip breaker is versatile and the first choice for medium machining of Stainless steels. It features positive rake angle and positive, wide T-land. It's also suitable for Steels and Super-alloys.

TNMG 160404E-NMR:T6310	● 0.4	■	130	0.20	1.7	■	90	0.18	1.7	—	—	—	—	—	—	■	35	0.18	1.4	—	—	—
TNMG 160404E-NMR:T7325	● 0.4	✓	145	0.20	1.7	■	110	0.18	1.7	—	—	—	—	—	—	■	45	0.18	1.4	—	—	—
TNMG 160404E-NMR:T7335	● 0.4	✓	145	0.20	1.7	■	110	0.18	1.7	—	—	—	—	—	—	■	45	0.18	1.4	—	—	—
TNMG 160404E-NMR:T8430	● 0.4	■	145	0.20	1.7	■	80	0.18	1.7	—	—	—	—	—	—	■	30	0.18	1.4	—	—	—
TNMG 160404E-NMR:T9325	● 0.4	■	180	0.20	1.7	■	105	0.18	1.7	—	—	—	—	—	—	■	40	0.18	1.4	—	—	—

Suitability and starting values for cutting speed (vc), feed (f) and depth of cut (ap). Refer to our Machining Calculator app for further calculations.

Product	RE (mm)	P			M			K			N			S			H		
		vc (m/min)	f (mm/rev)	ap (mm)	vc (m/min)	f (mm/rev)	ap (mm)	vc (m/min)	f (mm/rev)	ap (mm)	vc (m/min)	f (mm/rev)	ap (mm)	vc (m/min)	f (mm/rev)	ap (mm)	vc (m/min)	f (mm/rev)	ap (mm)

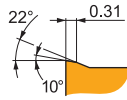
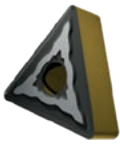

NMR chip breaker is versatile and the first choice for medium machining of Stainless steels. It features positive rake angle and positive, wide T-land. It's also suitable for Steels and Super-alloys.

TNMG 160408E-NMR:T6310	0.8	140	0.30	1.7	100	0.27	1.7	-	-	-	-	-	40	0.24	1.4	-	-	-
TNMG 160408E-NMR:T7325	0.8	155	0.30	1.7	120	0.27	1.7	-	-	-	-	-	50	0.24	1.4	-	-	-
TNMG 160408E-NMR:T7335	0.8	145	0.30	1.7	110	0.27	1.7	-	-	-	-	-	45	0.24	1.4	-	-	-
TNMG 160408E-NMR:T8430	0.8	150	0.30	1.7	80	0.27	1.7	-	-	-	-	-	30	0.24	1.4	-	-	-
TNMG 160408E-NMR:T9325	0.8	185	0.30	1.7	110	0.27	1.7	-	-	-	-	-	40	0.24	1.4	-	-	-
TNMG 160408E-NMR:T9415	0.8	235	0.30	1.7	-	-	-	-	-	-	-	-	-	-	-	-	-	-
TNMG 160412E-NMR:T7325	1.2	165	0.30	1.7	125	0.27	1.7	-	-	-	-	-	50	0.24	1.4	-	-	-
TNMG 160412E-NMR:T8430	1.2	155	0.30	1.7	85	0.27	1.7	-	-	-	-	-	30	0.24	1.4	-	-	-
TNMG 160412E-NMR:T9415	1.2	250	0.30	1.7	-	-	-	-	-	-	-	-	-	-	-	-	-	-
TNMG 220408E-NMR:T6310	0.8	135	0.30	2.1	95	0.27	2.1	-	-	-	-	-	40	0.24	1.7	-	-	-
TNMG 220408E-NMR:T7325	0.8	150	0.30	2.1	115	0.27	2.1	-	-	-	-	-	45	0.24	1.7	-	-	-
TNMG 220408E-NMR:T7335	0.8	145	0.30	2.1	110	0.27	2.1	-	-	-	-	-	45	0.24	1.7	-	-	-
TNMG 220408E-NMR:T8430	0.8	145	0.30	2.1	80	0.27	2.1	-	-	-	-	-	30	0.24	1.7	-	-	-
TNMG 220408E-NMR:T9325	0.8	180	0.30	2.1	105	0.27	2.1	-	-	-	-	-	40	0.24	1.7	-	-	-
TNMG 220412E-NMR:T6310	1.2	140	0.30	2.1	100	0.27	2.1	-	-	-	-	-	40	0.24	1.7	-	-	-
TNMG 220412E-NMR:T7325	1.2	160	0.30	2.1	120	0.27	2.1	-	-	-	-	-	50	0.24	1.7	-	-	-
TNMG 220412E-NMR:T9325	1.2	190	0.30	2.1	110	0.27	2.1	-	-	-	-	-	40	0.24	1.7	-	-	-
TNMG 220412E-NMR:T9415	1.2	245	0.30	2.1	-	-	-	-	-	-	-	-	-	-	-	-	-	-

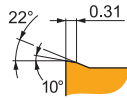

NMR chip breaker is versatile and the first choice for medium machining of Stainless steels. It features positive rake angle and positive, wide T-land. It's also suitable for Steels and Super-alloys.

VNMG 160404E-NMR:T7325	0.4	125	0.20	1.2	95	0.18	1.2	-	-	-	-	-	40	0.18	1.0	-	-	-
VNMG 160404E-NMR:T9325	0.4	155	0.20	1.2	90	0.18	1.2	-	-	-	-	-	30	0.18	1.0	-	-	-
VNMG 160408E-NMR:T7325	0.8	130	0.30	1.4	100	0.27	1.4	-	-	-	-	-	40	0.24	1.1	-	-	-
VNMG 160408E-NMR:T8430	0.8	125	0.30	1.4	65	0.27	1.4	-	-	-	-	-	25	0.24	1.1	-	-	-
VNMG 160408E-NMR:T9325	0.8	150	0.30	1.4	90	0.27	1.4	-	-	-	-	-	30	0.24	1.1	-	-	-
VNMG 160408E-NMR:T9415	0.8	200	0.30	1.4	-	-	-	-	-	-	-	-	-	-	-	-	-	-
VNMG 160412E-NMR:T8430	1.2	130	0.30	1.4	70	0.27	1.4	-	-	-	-	-	25	0.24	1.1	-	-	-

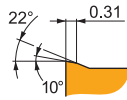
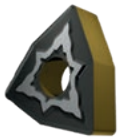

NMR chip breaker is versatile and the first choice for medium machining of Stainless steels. It features positive rake angle and positive, wide T-land. It's also suitable for Steels and Super-alloys.

WNMG 060404E-NMR:T6310	0.4	145	0.25	1.6	100	0.23	1.6	-	-	-	-	-	40	0.20	1.3	-	-	-
WNMG 060404E-NMR:T7325	0.4	160	0.25	1.6	120	0.23	1.6	-	-	-	-	-	50	0.20	1.3	-	-	-
WNMG 060404E-NMR:T8430	0.4	165	0.25	1.6	90	0.23	1.6	-	-	-	-	-	35	0.20	1.3	-	-	-
WNMG 060404E-NMR:T9325	0.4	200	0.25	1.6	120	0.23	1.6	-	-	-	-	-	45	0.20	1.3	-	-	-
WNMG 060408E-NMR:T7325	0.8	175	0.35	1.6	135	0.32	1.6	-	-	-	-	-	55	0.25	1.3	-	-	-
WNMG 060408E-NMR:T7335	0.8	170	0.35	1.6	130	0.32	1.6	-	-	-	-	-	55	0.25	1.3	-	-	-
WNMG 060408E-NMR:T8430	0.8	155	0.35	2.7	85	0.32	2.7	-	-	-	-	-	30	0.25	2.2	-	-	-
WNMG 060408E-NMR:T9325	0.8	200	0.35	1.6	120	0.32	1.6	-	-	-	-	-	45	0.25	1.3	-	-	-
WNMG 080404E-NMR:T6310	0.4	140	0.25	2.7	100	0.23	2.7	-	-	-	-	-	40	0.20	2.2	-	-	-
WNMG 080404E-NMR:T7325	0.4	155	0.25	2.7	120	0.23	2.7	-	-	-	-	-	50	0.20	2.2	-	-	-
WNMG 080404E-NMR:T7335	0.4	150	0.25	2.7	115	0.23	2.7	-	-	-	-	-	45	0.20	2.2	-	-	-
WNMG 080404E-NMR:T8430	0.4	150	0.25	2.7	80	0.23	2.7	-	-	-	-	-	30	0.20	2.2	-	-	-
WNMG 080404E-NMR:T9415	0.4	240	0.25	2.7	-	-	-	-	-	-	-	-	-	-	-	-	-	-
WNMG 080408E-NMR:T6310	0.8	150	0.35	2.7	105	0.32	2.7	-	-	-	-	-	45	0.25	2.2	-	-	-
WNMG 080408E-NMR:T7325	0.8	170	0.35	2.7	130	0.32	2.7	-	-	-	-	-	55	0.25	2.2	-	-	-
WNMG 080408E-NMR:T7335	0.8	160	0.35	2.7	120	0.32	2.7	-	-	-	-	-	50	0.25	2.2	-	-	-
WNMG 080408E-NMR:T8430	0.8	155	0.35	2.7	85	0.32	2.7	-	-	-	-	-	30	0.25	2.2	-	-	-
WNMG 080408E-NMR:T9325	0.8	190	0.35	2.7	110	0.32	2.7	-	-	-	-	-	40	0.25	2.2	-	-	-
WNMG 080408E-NMR:T9415	0.8	255	0.35	2.7	-	-	-	-	-	-	-	-	-	-	-	-	-	-
WNMG 080412E-NMR:T6310	1.2	150	0.40	2.7	105	0.36	2.7	-	-	-	-	-	45	0.28	2.2	-	-	-
WNMG 080412E-NMR:T7325	1.2	170	0.40	2.7	130	0.36	2.7	-	-	-	-	-	55	0.28	2.2	-	-	-
WNMG 080412E-NMR:T7335	1.2	160	0.40	2.7	120	0.36	2.7	-	-	-	-	-	50	0.28	2.2	-	-	-
WNMG 080412E-NMR:T8430	1.2	155	0.40	2.7	85	0.36	2.7	-	-	-	-	-	30	0.28	2.2	-	-	-
WNMG 080412E-NMR:T9325	1.2	190	0.40	2.7	110	0.36	2.7	-	-	-	-	-	40	0.28	2.2	-	-	-
WNMG 080412E-NMR:T9415	1.2	255	0.40	2.7	-	-	-	-	-	-	-	-	-	-	-	-	-	-

NM

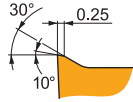

NM chip breaker is sharp and designed for medium machining of Steels, Stainless steels and Super-alloys. It features highly positive rake angle and positive, moderate T-land. It's also conditionally suitable for Non-ferrous alloys.



CNMG

	IC (mm)	D1 (mm)	L (mm)	S (mm)
1204	12.700	5.16	12.90	4.76
1606	15.875	6.35	16.10	6.35
1906	19.050	7.94	19.30	6.35

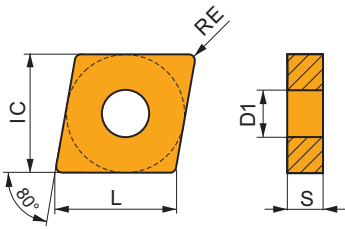

DNMG

	IC (mm)	D1 (mm)	L (mm)	S (mm)
1104	9.525	3.81	11.60	4.76
1504	12.700	5.16	15.50	4.76
1506	12.700	5.16	15.50	6.35

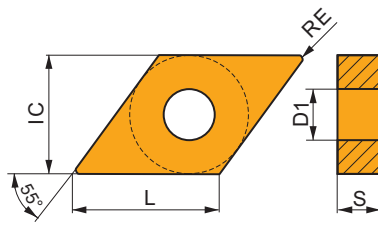

SNMG

	IC (mm)	D1 (mm)	L (mm)	S (mm)
1204	12.700	5.16	12.70	4.76

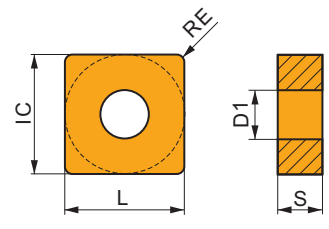

TNMG

	IC (mm)	D1 (mm)	L (mm)	S (mm)
1604	9.525	3.81	16.50	4.76
2204	12.700	5.16	22.00	4.76

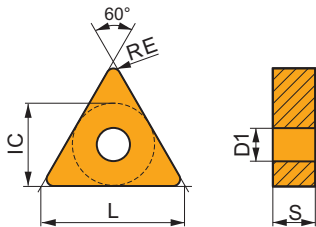

VNMG

	IC (mm)	D1 (mm)	L (mm)	S (mm)
1604	9.525	3.81	16.60	4.76

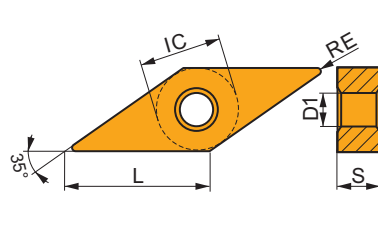

WNMG

	IC (mm)	D1 (mm)	L (mm)	S (mm)
0604	9.525	3.81	6.50	4.76
0804	12.700	5.16	8.70	4.76

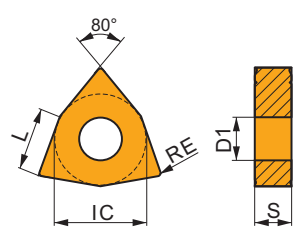

Suitability and starting values for cutting speed (vc), feed (f) and depth of cut (ap). Refer to our Machining Calculator app for further calculations.

Product	RE (mm)	P			M			K			N			S			H		
		vc (m/min)	f (mm/rev)	ap (mm)	vc (m/min)	f (mm/rev)	ap (mm)	vc (m/min)	f (mm/rev)	ap (mm)	vc (m/min)	f (mm/rev)	ap (mm)	vc (m/min)	f (mm/rev)	ap (mm)	vc (m/min)	f (mm/rev)	ap (mm)

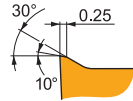
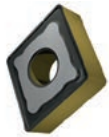

NM chip breaker is sharp and designed for medium machining of Steels, Stainless steels and Super-alloys. It features highly positive rake angle and positive, moderate T-land. It's also conditionally suitable for Non-ferrous alloys.

CNMG 120404E-NM:T7325	●	0.4	195	0.20	2.1	150	0.18	2.1	-	-	-	-	60	0.16	1.7	-	-	-		
CNMG 120404E-NM:T7335	●	0.4	190	0.20	2.1	145	0.18	2.1	-	-	-	-	60	0.16	1.7	-	-	-		
CNMG 120404E-NM:T8430	●	0.4	195	0.20	2.1	105	0.18	2.1	-	-	-	540	0.24	2.1	40	0.16	1.7	-	-	-
CNMG 120404E-NM:T9325	●	0.4	240	0.20	2.1	140	0.18	2.1	-	-	-	-	50	0.16	1.7	-	-	-		
CNMG 120404E-NM:T9415	●	0.4	305	0.20	2.1	-	-	-	-	-	-	-	-	-	-	-	-	-		
CNMG 120408E-NM:T7325	●	0.8	215	0.25	2.1	165	0.23	2.1	-	-	-	-	65	0.20	1.7	-	-	-		
CNMG 120408E-NM:T7335	●	0.8	210	0.25	2.1	160	0.23	2.1	-	-	-	-	65	0.20	1.7	-	-	-		
CNMG 120408E-NM:T8315	●	0.8	205	0.25	2.1	120	0.23	2.1	-	-	-	615	0.30	2.1	50	0.20	1.7	-	-	-
CNMG 120408E-NM:T8415	●	0.8	245	0.25	2.1	125	0.23	2.1	-	-	-	615	0.30	2.1	55	0.20	1.7	-	-	-
CNMG 120408E-NM:T8430	●	0.8	210	0.25	2.1	115	0.23	2.1	-	-	-	585	0.30	2.1	45	0.20	1.7	-	-	-
CNMG 120408E-NM:T9315	●	0.8	290	0.25	2.1	-	-	-	-	-	-	-	-	-	-	-	-	-		
CNMG 120408E-NM:T9325	●	0.8	260	0.25	2.1	155	0.23	2.1	-	-	-	-	55	0.20	1.7	-	-	-		
CNMG 120408E-NM:T9415	●	0.8	335	0.25	2.1	-	-	-	-	-	-	-	-	-	-	-	-	-		
CNMG 120412E-NM:T7325	●	1.2	215	0.30	2.1	165	0.27	2.1	-	-	-	-	65	0.24	1.7	-	-	-		
CNMG 120412E-NM:T7335	●	1.2	210	0.30	2.1	160	0.27	2.1	-	-	-	-	65	0.24	1.7	-	-	-		
CNMG 120412E-NM:T8430	●	1.2	210	0.30	2.1	115	0.27	2.1	-	-	-	585	0.36	2.1	45	0.24	1.7	-	-	-
CNMG 120412E-NM:T9325	●	1.2	255	0.30	2.1	150	0.27	2.1	-	-	-	-	55	0.24	1.7	-	-	-		
CNMG 160608E-NM:T7325	●	0.8	195	0.30	3.6	150	0.27	3.6	-	-	-	-	60	0.27	2.9	-	-	-		
CNMG 160608E-NM:T7335	●	0.8	190	0.30	3.6	145	0.27	3.6	-	-	-	-	60	0.27	2.9	-	-	-		
CNMG 160608E-NM:T8430	●	0.8	185	0.30	3.6	100	0.27	3.6	-	-	-	510	0.36	3.6	40	0.27	2.9	-	-	-
CNMG 160608E-NM:T9325	●	0.8	225	0.30	3.6	135	0.27	3.6	-	-	-	-	50	0.27	2.9	-	-	-		
CNMG 160612E-NM:T7325	●	1.2	205	0.30	3.6	155	0.27	3.6	-	-	-	-	65	0.27	2.9	-	-	-		
CNMG 160612E-NM:T7335	●	1.2	200	0.30	3.6	155	0.27	3.6	-	-	-	-	65	0.27	2.9	-	-	-		
CNMG 160612E-NM:T8315	●	1.2	195	0.30	3.6	115	0.27	3.6	-	-	-	585	0.36	3.6	45	0.27	2.9	-	-	-
CNMG 160612E-NM:T9325	●	1.2	240	0.30	3.6	140	0.27	3.6	-	-	-	-	50	0.27	2.9	-	-	-		
CNMG 190612E-NM:T7325	●	1.2	195	0.35	4.2	150	0.32	4.2	-	-	-	-	60	0.32	3.4	-	-	-		
CNMG 190612E-NM:T7335	●	1.2	180	0.35	4.2	140	0.32	4.2	-	-	-	-	55	0.32	3.4	-	-	-		
CNMG 190612E-NM:T8430	●	1.2	180	0.35	4.2	95	0.32	4.2	-	-	-	495	0.42	4.2	35	0.32	3.4	-	-	-
CNMG 190612E-NM:T9325	●	1.2	220	0.35	4.2	130	0.32	4.2	-	-	-	-	45	0.32	3.4	-	-	-		

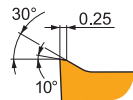

NM chip breaker is sharp and designed for medium machining of Steels, Stainless steels and Super-alloys. It features highly positive rake angle and positive, moderate T-land. It's also conditionally suitable for Non-ferrous alloys.

DNMG 110404E-NM:T7325	●	0.4	175	0.20	0.8	135	0.18	0.8	-	-	-	-	55	0.20	0.6	-	-	-		
DNMG 110404E-NM:T7335	●	0.4	165	0.20	0.8	125	0.18	0.8	-	-	-	-	50	0.20	0.6	-	-	-		
DNMG 110404E-NM:T8430	●	0.4	175	0.20	0.8	95	0.18	0.8	-	-	-	480	0.24	0.8	35	0.20	0.6	-	-	-
DNMG 110404E-NM:T9325	●	0.4	210	0.20	0.8	125	0.18	0.8	-	-	-	-	45	0.20	0.6	-	-	-		
DNMG 110408E-NM:T7325	●	0.8	190	0.25	0.8	145	0.23	0.8	-	-	-	-	60	0.20	0.6	-	-	-		
DNMG 110408E-NM:T7335	●	0.8	185	0.25	0.8	140	0.23	0.8	-	-	-	-	60	0.20	0.6	-	-	-		
DNMG 110408E-NM:T8315	●	0.8	180	0.25	0.8	105	0.23	0.8	-	-	-	540	0.30	0.8	45	0.20	0.6	-	-	-
DNMG 110408E-NM:T8415	●	0.8	215	0.25	0.8	110	0.23	0.8	-	-	-	540	0.30	0.8	45	0.20	0.6	-	-	-
DNMG 110408E-NM:T8430	●	0.8	190	0.25	0.8	105	0.23	0.8	-	-	-	525	0.30	0.8	40	0.20	0.6	-	-	-
DNMG 110408E-NM:T9325	●	0.8	230	0.25	0.8	135	0.23	0.8	-	-	-	-	50	0.20	0.6	-	-	-		
DNMG 150408E-NM:T8430	●	0.8	175	0.25	1.9	95	0.23	1.9	-	-	-	480	0.30	1.9	35	0.20	1.5	-	-	-
DNMG 150408E-NM:T9325	●	0.8	210	0.25	1.9	125	0.23	1.9	-	-	-	-	45	0.20	1.5	-	-	-		
DNMG 150604E-NM:T7325	●	0.4	160	0.20	1.9	120	0.18	1.9	-	-	-	-	50	0.20	1.5	-	-	-		
DNMG 150604E-NM:T7335	●	0.4	150	0.20	1.9	115	0.18	1.9	-	-	-	-	45	0.20	1.5	-	-	-		
DNMG 150604E-NM:T8430	●	0.4	155	0.20	1.9	85	0.18	1.9	-	-	-	435	0.24	1.9	30	0.20	1.5	-	-	-
DNMG 150604E-NM:T9325	●	0.4	195	0.20	1.9	115	0.18	1.9	-	-	-	-	40	0.20	1.5	-	-	-		
DNMG 150608E-NM:T7325	●	0.8	175	0.25	1.9	135	0.23	1.9	-	-	-	-	55	0.20	1.5	-	-	-		
DNMG 150608E-NM:T7335	●	0.8	170	0.25	1.9	130	0.23	1.9	-	-	-	-	55	0.20	1.5	-	-	-		
DNMG 150608E-NM:T8315	●	0.8	165	0.25	1.9	95	0.23	1.9	-	-	-	495	0.30	1.9	40	0.20	1.5	-	-	-
DNMG 150608E-NM:T8430	●	0.8	175	0.25	1.9	95	0.23	1.9	-	-	-	480	0.30	1.9	35	0.20	1.5	-	-	-
DNMG 150608E-NM:T9325	●	0.8	210	0.25	1.9	125	0.23	1.9	-	-	-	-	45	0.20	1.5	-	-	-		
DNMG 150608E-NM:T9415	●	0.8	275	0.25	1.9	-	-	-	-	-	-	-	-	-	-	-	-	-		
DNMG 150612E-NM:T7325	●	1.2	175	0.30	1.9	135	0.27	1.9	-	-	-	-	55	0.24	1.5	-	-	-		
DNMG 150612E-NM:T7335	●	1.2	170	0.30	1.9	130	0.27	1.9	-	-	-	-	55	0.24	1.5	-	-	-		
DNMG 150612E-NM:T9325	●	1.2	205	0.30	1.9	120	0.27	1.9	-	-	-	-	45	0.24	1.5	-	-	-		

Suitability and starting values for cutting speed (vc), feed (f) and depth of cut (ap). Refer to our Machining Calculator app for further calculations.

Product	RE (mm)	P			M			K			N			S			H		
		vc (m/min)	f (mm/rev)	ap (mm)	vc (m/min)	f (mm/rev)	ap (mm)	vc (m/min)	f (mm/rev)	ap (mm)	vc (m/min)	f (mm/rev)	ap (mm)	vc (m/min)	f (mm/rev)	ap (mm)	vc (m/min)	f (mm/rev)	ap (mm)

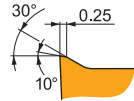

NM chip breaker is sharp and designed for medium machining of Steels, Stainless steels and Super-alloys. It features highly positive rake angle and positive, moderate T-land. It's also conditionally suitable for Non-ferrous alloys.

SNMG 120408E-NM:T7325	0.8	225	0.25	2.1	175	0.23	2.1	-	-	-	-	-	70	0.20	1.7	-	-	-	
SNMG 120408E-NM:T7335	0.8	220	0.25	2.1	170	0.23	2.1	-	-	-	-	-	70	0.20	1.7	-	-	-	
SNMG 120408E-NM:T8430	0.8	225	0.25	2.1	120	0.23	2.1	-	-	-	615	0.30	2.1	45	0.20	1.7	-	-	-
SNMG 120408E-NM:T9325	0.8	275	0.25	2.1	165	0.23	2.1	-	-	-	-	-	60	0.20	1.7	-	-	-	
SNMG 120412E-NM:T7325	1.2	225	0.30	2.1	175	0.27	2.1	-	-	-	-	-	70	0.24	1.7	-	-	-	
SNMG 120412E-NM:T7335	1.2	220	0.30	2.1	170	0.27	2.1	-	-	-	-	-	70	0.24	1.7	-	-	-	
SNMG 120412E-NM:T9325	1.2	270	0.30	2.1	160	0.27	2.1	-	-	-	-	-	60	0.24	1.7	-	-	-	

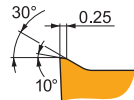
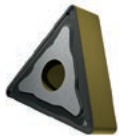

NM chip breaker is sharp and designed for medium machining of Steels, Stainless steels and Super-alloys. It features highly positive rake angle and positive, moderate T-land. It's also conditionally suitable for Non-ferrous alloys.

TNMG 160404E-NM:T7325	0.4	170	0.20	1.9	130	0.18	1.9	-	-	-	-	-	55	0.20	1.5	-	-	-	
TNMG 160404E-NM:T7335	0.4	160	0.20	1.9	120	0.18	1.9	-	-	-	-	-	50	0.20	1.5	-	-	-	
TNMG 160404E-NM:T8430	0.4	170	0.20	1.9	90	0.18	1.9	-	-	-	465	0.24	1.9	35	0.20	1.5	-	-	-
TNMG 160404E-NM:T9325	0.4	210	0.20	1.9	125	0.18	1.9	-	-	-	-	-	45	0.20	1.5	-	-	-	
TNMG 160408E-NM:T7325	0.8	190	0.25	1.9	145	0.23	1.9	-	-	-	-	-	60	0.20	1.5	-	-	-	
TNMG 160408E-NM:T7335	0.8	180	0.25	1.9	140	0.23	1.9	-	-	-	-	-	55	0.20	1.5	-	-	-	
TNMG 160408E-NM:T8315	0.8	175	0.25	1.9	105	0.23	1.9	-	-	-	525	0.30	1.9	40	0.20	1.5	-	-	-
TNMG 160408E-NM:T8415	0.8	215	0.25	1.9	110	0.23	1.9	-	-	-	540	0.30	1.9	45	0.20	1.5	-	-	-
TNMG 160408E-NM:T8430	0.8	185	0.25	1.9	100	0.23	1.9	-	-	-	510	0.30	1.9	40	0.20	1.5	-	-	-
TNMG 160408E-NM:T9325	0.8	225	0.25	1.9	135	0.23	1.9	-	-	-	-	-	50	0.20	1.5	-	-	-	
TNMG 160408E-NM:T9415	0.8	290	0.25	1.9	-	-	-	-	-	-	-	-	-	-	-	-	-	-	
TNMG 220408E-NM:T7325	0.8	190	0.25	1.7	145	0.23	1.7	-	-	-	-	-	60	0.20	1.4	-	-	-	
TNMG 220408E-NM:T7335	0.8	185	0.25	1.7	140	0.23	1.7	-	-	-	-	-	60	0.20	1.4	-	-	-	
TNMG 220408E-NM:T8315	0.8	175	0.25	1.7	105	0.23	1.7	-	-	-	525	0.30	1.7	40	0.20	1.4	-	-	-
TNMG 220408E-NM:T8415	0.8	215	0.25	1.7	110	0.23	1.7	-	-	-	540	0.30	1.7	45	0.20	1.4	-	-	-
TNMG 220408E-NM:T8430	0.8	185	0.25	1.7	100	0.23	1.7	-	-	-	510	0.30	1.7	40	0.20	1.4	-	-	-
TNMG 220408E-NM:T9325	0.8	225	0.25	1.7	135	0.23	1.7	-	-	-	-	-	50	0.20	1.4	-	-	-	
TNMG 220412E-NM:T7325	1.2	190	0.30	1.7	145	0.27	1.7	-	-	-	-	-	60	0.24	1.4	-	-	-	
TNMG 220412E-NM:T7335	1.2	180	0.30	2.1	140	0.27	2.1	-	-	-	-	-	55	0.24	1.7	-	-	-	
TNMG 220412E-NM:T9325	1.2	215	0.30	2.1	125	0.27	2.1	-	-	-	-	-	45	0.24	1.7	-	-	-	

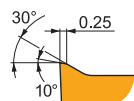

NM chip breaker is sharp and designed for medium machining of Steels, Stainless steels and Super-alloys. It features highly positive rake angle and positive, moderate T-land. It's also conditionally suitable for Non-ferrous alloys.

VNMG 160404E-NM:T7325	0.4	145	0.20	1.2	110	0.18	1.2	-	-	-	-	-	45	0.20	1.0	-	-	-	
VNMG 160404E-NM:T7335	0.4	140	0.20	1.2	105	0.18	1.2	-	-	-	-	-	45	0.20	1.0	-	-	-	
VNMG 160404E-NM:T8315	0.4	135	0.20	1.2	80	0.18	1.2	-	-	-	405	0.24	1.2	30	0.20	1.0	-	-	-
VNMG 160404E-NM:T8415	0.4	160	0.20	1.2	85	0.18	1.2	-	-	-	405	0.24	1.2	35	0.20	1.0	-	-	-
VNMG 160404E-NM:T8430	0.4	145	0.20	1.2	80	0.18	1.2	-	-	-	405	0.24	1.2	30	0.20	1.0	-	-	-
VNMG 160404E-NM:T9325	0.4	180	0.20	1.2	105	0.18	1.2	-	-	-	-	-	40	0.20	1.0	-	-	-	
VNMG 160408E-NM:T7325	0.8	160	0.25	1.4	120	0.23	1.4	-	-	-	-	-	50	0.20	1.1	-	-	-	
VNMG 160408E-NM:T7335	0.8	155	0.25	1.4	120	0.23	1.4	-	-	-	-	-	50	0.20	1.1	-	-	-	
VNMG 160408E-NM:T8315	0.8	145	0.25	1.4	85	0.23	1.4	-	-	-	435	0.30	1.4	35	0.20	1.1	-	-	-
VNMG 160408E-NM:T8415	0.8	180	0.25	1.4	90	0.23	1.4	-	-	-	450	0.30	1.4	40	0.20	1.1	-	-	-
VNMG 160408E-NM:T8430	0.8	155	0.25	1.4	85	0.23	1.4	-	-	-	435	0.30	1.4	30	0.20	1.1	-	-	-
VNMG 160408E-NM:T9325	0.8	190	0.25	1.4	110	0.23	1.4	-	-	-	-	-	40	0.20	1.1	-	-	-	

Suitability and starting values for cutting speed (vc), feed (f) and depth of cut (ap). Refer to our Machining Calculator app for further calculations.

Product	RE (mm)	P			M			K			N			S			H		
		vc (m/min)	f (mm/rev)	ap (mm)	vc (m/min)	f (mm/rev)	ap (mm)	vc (m/min)	f (mm/rev)	ap (mm)	vc (m/min)	f (mm/rev)	ap (mm)	vc (m/min)	f (mm/rev)	ap (mm)	vc (m/min)	f (mm/rev)	ap (mm)

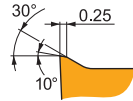
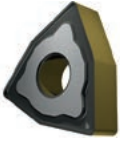

NM chip breaker is sharp and designed for medium machining of Steels, Stainless steels and Super-alloys. It features highly positive rake angle and positive, moderate T-land. It's also conditionally suitable for Non-ferrous alloys.

WNMG 060404E-NM:T7325	●	0.4	200	0.20	1.8	155	0.18	1.8	-	-	-	-	-	-	65	0.16	1.4	-	-	-
WNMG 060404E-NM:T7335	●	0.4	195	0.20	1.8	150	0.18	1.8	-	-	-	-	-	-	60	0.16	1.4	-	-	-
WNMG 060404E-NM:T8430	●	0.4	185	0.25	1.8	100	0.23	1.8	-	-	-	510	0.30	1.8	40	0.20	1.4	-	-	-
WNMG 060404E-NM:T9325	●	0.4	245	0.20	1.8	145	0.18	1.8	-	-	-	-	-	-	55	0.16	1.4	-	-	-
WNMG 060408E-NM:T7325	●	0.8	220	0.25	1.8	170	0.23	1.8	-	-	-	-	-	-	70	0.20	1.4	-	-	-
WNMG 060408E-NM:T7335	●	0.8	215	0.25	1.8	165	0.23	1.8	-	-	-	-	-	-	65	0.20	1.4	-	-	-
WNMG 060408E-NM:T8430	●	0.8	220	0.25	1.8	120	0.23	1.8	-	-	-	600	0.30	1.8	45	0.20	1.4	-	-	-
WNMG 060408E-NM:T9325	●	0.8	265	0.25	1.8	155	0.23	1.8	-	-	-	-	-	-	55	0.20	1.4	-	-	-
WNMG 060412E-NM:T7325	●	1.2	220	0.30	1.8	170	0.27	1.8	-	-	-	-	-	-	70	0.24	1.4	-	-	-
WNMG 060412E-NM:T7335	●	1.2	220	0.30	1.2	170	0.27	1.2	-	-	-	-	-	-	70	0.24	1.0	-	-	-
WNMG 060412E-NM:T9325	●	1.2	255	0.30	1.8	150	0.27	1.8	-	-	-	-	-	-	55	0.24	1.4	-	-	-
WNMG 080404E-NM:T7325	●	0.4	195	0.20	2.1	150	0.18	2.1	-	-	-	-	-	-	60	0.16	1.7	-	-	-
WNMG 080404E-NM:T7335	●	0.4	190	0.20	2.1	145	0.18	2.1	-	-	-	-	-	-	60	0.16	1.7	-	-	-
WNMG 080404E-NM:T8430	●	0.4	180	0.25	2.1	95	0.23	2.1	-	-	-	495	0.30	2.1	35	0.20	1.7	-	-	-
WNMG 080404E-NM:T9315	●	0.4	270	0.20	2.1	-	-	-	-	-	-	-	-	-	-	-	-	-	-	-
WNMG 080404E-NM:T9325	●	0.4	240	0.20	2.1	140	0.18	2.1	-	-	-	-	-	-	50	0.16	1.7	-	-	-
WNMG 080404E-NM:T9415	●	0.4	305	0.20	2.1	-	-	-	-	-	-	-	-	-	-	-	-	-	-	-
WNMG 080408E-NM:T7325	●	0.8	215	0.25	2.1	165	0.23	2.1	-	-	-	-	-	-	65	0.20	1.7	-	-	-
WNMG 080408E-NM:T7335	●	0.8	210	0.25	2.1	160	0.23	2.1	-	-	-	-	-	-	65	0.20	1.7	-	-	-
WNMG 080408E-NM:T8315	●	0.8	205	0.25	2.1	120	0.23	2.1	-	-	-	615	0.30	2.1	50	0.20	1.7	-	-	-
WNMG 080408E-NM:T8430	●	0.8	210	0.25	2.1	115	0.23	2.1	-	-	-	585	0.30	2.1	45	0.20	1.7	-	-	-
WNMG 080408E-NM:T9315	●	0.8	290	0.25	2.1	-	-	-	-	-	-	-	-	-	-	-	-	-	-	-
WNMG 080408E-NM:T9325	●	0.8	260	0.25	2.1	155	0.23	2.1	-	-	-	-	-	-	55	0.20	1.7	-	-	-
WNMG 080408E-NM:T9415	●	0.8	335	0.25	2.1	-	-	-	-	-	-	-	-	-	-	-	-	-	-	-
WNMG 080412E-NM:T7325	●	1.2	215	0.30	2.1	165	0.27	2.1	-	-	-	-	-	-	65	0.24	1.7	-	-	-
WNMG 080412E-NM:T7335	●	1.2	210	0.30	2.1	160	0.27	2.1	-	-	-	-	-	-	65	0.24	1.7	-	-	-
WNMG 080412E-NM:T8315	●	1.2	205	0.30	2.1	120	0.27	2.1	-	-	-	615	0.36	2.1	50	0.24	1.7	-	-	-
WNMG 080412E-NM:T8415	●	1.2	245	0.30	2.1	125	0.27	2.1	-	-	-	615	0.36	2.1	55	0.24	1.7	-	-	-
WNMG 080412E-NM:T9325	●	1.2	255	0.30	2.1	150	0.27	2.1	-	-	-	-	-	-	55	0.24	1.7	-	-	-

.NMA

.NMA flat insert is designed for medium machining of Cast irons. It features neutral rake angle without T-land. It's also conditionally suitable for Hard materials.

PRAMET

.NMA
..S

.NMA..S flat insert is designed for medium machining of Cast irons. It features neutral rake angle and negative, moderate T-land. It's also conditionally suitable for Hard materials.

PRAMET

CNMA

	IC	D1	L	S
	(mm)	(mm)	(mm)	(mm)
1204	12.700	5.16	12.90	4.76
1606	15.875	6.35	16.10	6.35
1906	19.050	7.94	19.30	6.35

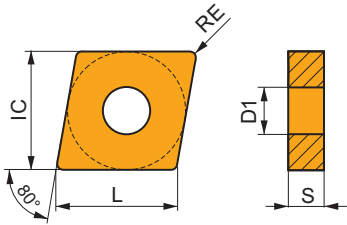

DNMA

	IC	D1	L	S
	(mm)	(mm)	(mm)	(mm)
1504	12.700	5.16	15.50	4.76
1506	12.700	5.16	15.50	6.35

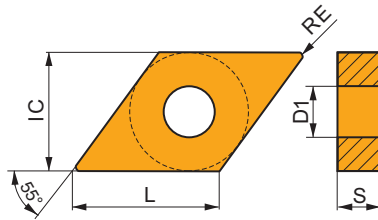

SNMA

	IC	D1	L	S
	(mm)	(mm)	(mm)	(mm)
1204	12.700	5.16	12.70	4.76
1506	15.875	6.35	15.88	6.35
1906	19.050	7.94	19.05	6.35
2507	25.400	9.12	25.40	7.94
2509	25.400	9.12	25.40	9.53

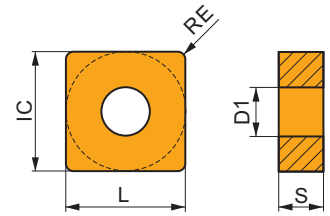

TNMA

	IC	D1	L	S
	(mm)	(mm)	(mm)	(mm)
1604	9.525	3.81	16.50	4.76
2204	12.700	5.16	22.00	4.76

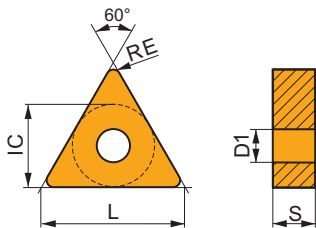

WNMA

	IC	D1	L	S
	(mm)	(mm)	(mm)	(mm)
0804	12.700	5.16	8.70	4.76

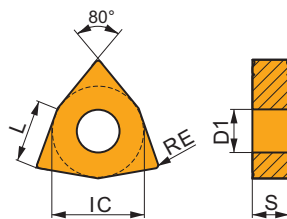

Suitability and starting values for cutting speed (vc), feed (f) and depth of cut (ap). Refer to our Machining Calculator app for further calculations.

Product	RE (mm)	P			M			K			N			S			H		
		vc (m/min)	f (mm/rev)	ap (mm)	vc (m/min)	f (mm/rev)	ap (mm)	vc (m/min)	f (mm/rev)	ap (mm)	vc (m/min)	f (mm/rev)	ap (mm)	vc (m/min)	f (mm/rev)	ap (mm)	vc (m/min)	f (mm/rev)	ap (mm)

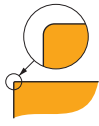
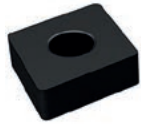

.NMA flat insert is designed for medium machining of Cast irons. It features neutral rake angle without T-land. It's also conditionally suitable for Hard materials.

CNMA 120404:T5305	●	0.4	-	-	-	-	-	-	■	235	0.10	4.0	-	-	-	-	-	-	■	50	0.10	0.3
CNMA 120404:T5315	●	0.4	-	-	-	-	-	-	■	200	0.10	4.0	-	-	-	-	-	-	■	40	0.10	0.3
CNMA 120408:T5305	●	0.8	-	-	-	-	-	-	■	220	0.20	4.0	-	-	-	-	-	-	■	45	0.10	0.7
CNMA 120408:T5315	●	0.8	-	-	-	-	-	-	■	190	0.20	4.0	-	-	-	-	-	-	■	40	0.10	0.7
CNMA 120408:T6310	●	0.8	-	-	-	-	-	-	■	100	0.20	4.0	-	-	-	-	-	-	■	25	0.10	0.7
CNMA 120408:T8415	●	0.8	-	-	-	-	-	-	■	145	0.20	4.0	-	-	-	-	-	-	■	25	0.14	0.5
CNMA 120412:T5305	●	1.2	-	-	-	-	-	-	■	195	0.30	4.0	-	-	-	-	-	-	■	40	0.15	1.0
CNMA 120412:T5315	●	1.2	-	-	-	-	-	-	■	180	0.30	4.0	-	-	-	-	-	-	■	35	0.15	1.0
CNMA 120412:T6310	●	1.2	-	-	-	-	-	-	■	95	0.30	4.0	-	-	-	-	-	-	■	20	0.15	1.0
CNMA 120412:T8415	●	1.2	-	-	-	-	-	-	■	135	0.30	4.0	-	-	-	-	-	-	■	25	0.21	0.5
CNMA 120416:T5305	●	1.6	-	-	-	-	-	-	■	190	0.40	4.0	-	-	-	-	-	-	■	40	0.20	1.3
CNMA 120416:T5315	●	1.6	-	-	-	-	-	-	■	170	0.40	4.0	-	-	-	-	-	-	■	35	0.20	1.3
CNMA 160612:T5305	●	1.2	-	-	-	-	-	-	■	190	0.30	5.0	-	-	-	-	-	-	■	40	0.15	1.0
CNMA 160612:T5315	●	1.2	-	-	-	-	-	-	■	175	0.30	5.0	-	-	-	-	-	-	■	35	0.15	1.0
CNMA 160616:T5315	●	1.6	-	-	-	-	-	-	■	165	0.40	5.0	-	-	-	-	-	-	■	35	0.20	1.3
CNMA 190612:T5305	●	1.2	-	-	-	-	-	-	■	190	0.30	6.0	-	-	-	-	-	-	■	40	0.15	1.0
CNMA 190612:T5315	●	1.2	-	-	-	-	-	-	■	170	0.30	6.0	-	-	-	-	-	-	■	35	0.15	1.0
CNMA 190616:T5305	●	1.6	-	-	-	-	-	-	■	180	0.40	6.0	-	-	-	-	-	-	■	35	0.20	1.3
CNMA 190616:T5315	●	1.6	-	-	-	-	-	-	■	160	0.40	6.0	-	-	-	-	-	-	■	30	0.20	1.3

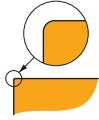

.NMA..S flat insert is designed for medium machining of Cast irons. It features neutral rake angle and negative, moderate T-land. It's also conditionally suitable for Hard materials.

CNMA 120408S:T5305	●	0.8	-	-	-	-	-	-	■	220	0.20	4.0	-	-	-	-	-	-	■	45	0.10	0.7
CNMA 120412S:T5305	●	1.2	-	-	-	-	-	-	■	190	0.40	4.0	-	-	-	-	-	-	■	40	0.20	1.3
CNMA 160612S:T5305	●	1.2	-	-	-	-	-	-	■	190	0.30	5.0	-	-	-	-	-	-	■	40	0.15	1.0
CNMA 190616S:T5305	●	1.6	-	-	-	-	-	-	■	180	0.40	6.0	-	-	-	-	-	-	■	35	0.20	1.3



.NMA flat insert is designed for medium machining of Cast irons. It features neutral rake angle without T-land. It's also conditionally suitable for Hard materials.

DNMA 150408:T5305	●	0.8	-	-	-	-	-	-	■	190	0.20	1.7	-	-	-	-	-	-	■	40	0.10	0.7
DNMA 150408:T5315	●	0.8	-	-	-	-	-	-	■	165	0.20	1.7	-	-	-	-	-	-	■	35	0.10	0.7
DNMA 150604:T5305	●	0.4	-	-	-	-	-	-	■	205	0.10	1.7	-	-	-	-	-	-	■	40	0.10	0.3
DNMA 150604:T5315	●	0.4	-	-	-	-	-	-	■	180	0.10	1.7	-	-	-	-	-	-	■	35	0.10	0.3
DNMA 150604:T6310	●	0.4	-	-	-	-	-	-	■	85	0.10	1.7	-	-	-	-	-	-	■	20	0.07	0.3
DNMA 150604:T8415	●	0.4	-	-	-	-	-	-	■	130	0.10	1.7	-	-	-	-	-	-	■	25	0.07	0.5
DNMA 150608:T5305	●	0.8	-	-	-	-	-	-	■	190	0.20	1.7	-	-	-	-	-	-	■	40	0.10	0.7
DNMA 150608:T5315	●	0.8	-	-	-	-	-	-	■	165	0.20	1.7	-	-	-	-	-	-	■	35	0.10	0.7
DNMA 150608:T6310	●	0.8	-	-	-	-	-	-	■	85	0.20	1.7	-	-	-	-	-	-	■	20	0.10	0.7
DNMA 150608:T8415	●	0.8	-	-	-	-	-	-	■	125	0.20	1.7	-	-	-	-	-	-	■	20	0.14	0.5
DNMA 150612:T5305	●	1.2	-	-	-	-	-	-	■	200	0.20	1.7	-	-	-	-	-	-	■	40	0.10	0.9
DNMA 150612:T5315	●	1.2	-	-	-	-	-	-	■	175	0.20	1.7	-	-	-	-	-	-	■	35	0.10	0.9

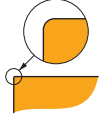

.NMA flat insert is designed for medium machining of Cast irons. It features neutral rake angle without T-land. It's also conditionally suitable for Hard materials.

SNMA 120408:T5305	●	0.8	-	-	-	-	-	-	■	230	0.20	4.0	-	-	-	-	-	-	■	45	0.10	0.7
SNMA 120408:T5315	●	0.8	-	-	-	-	-	-	■	200	0.20	4.0	-	-	-	-	-	-	■	40	0.10	0.7
SNMA 120408:T6310	●	0.8	-	-	-	-	-	-	■	100	0.20	4.0	-	-	-	-	-	-	■	25	0.10	0.7
SNMA 120408:T8415	●	0.8	-	-	-	-	-	-	■	150	0.20	4.0	-	-	-	-	-	-	■	25	0.14	0.5
SNMA 120412:T5305	●	1.2	-	-	-	-	-	-	■	205	0.30	4.0	-	-	-	-	-	-	■	40	0.15	1.0
SNMA 120412:T5315	●	1.2	-	-	-	-	-	-	■	190	0.30	4.0	-	-	-	-	-	-	■	40	0.15	1.0
SNMA 150612:T5305	●	1.2	-	-	-	-	-	-	■	200	0.30	5.0	-	-	-	-	-	-	■	40	0.15	1.0
SNMA 150612:T5315	●	1.2	-	-	-	-	-	-	■	185	0.30	5.0	-	-	-	-	-	-	■	35	0.15	1.0
SNMA 190612:T5305	●	1.2	-	-	-	-	-	-	■	195	0.30	6.0	-	-	-	-	-	-	■	40	0.15	1.0
SNMA 190612:T5315	●	1.2	-	-	-	-	-	-	■	180	0.30	6.0	-	-	-	-	-	-	■	35	0.15	1.0

Suitability and starting values for cutting speed (vc), feed (f) and depth of cut (ap). Refer to our Machining Calculator app for further calculations.

Product	RE (mm)	P			M			K			N			S			H		
		vc (m/min)	f (mm/rev)	ap (mm)	vc (m/min)	f (mm/rev)	ap (mm)	vc (m/min)	f (mm/rev)	ap (mm)	vc (m/min)	f (mm/rev)	ap (mm)	vc (m/min)	f (mm/rev)	ap (mm)	vc (m/min)	f (mm/rev)	ap (mm)

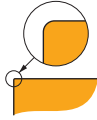

.NMA flat insert is designed for medium machining of Cast irons. It features neutral rake angle without T-land. It's also conditionally suitable for Hard materials.

SNMA 190616:T5305	1.6	-	-	-	-	-	-	190	0.40	6.0	-	-	-	-	-	-	40	0.20	1.3
SNMA 190616:T5315	1.6	-	-	-	-	-	-	170	0.40	6.0	-	-	-	-	-	-	35	0.20	1.3
SNMA 250724:T5305	2.4	-	-	-	-	-	-	95	0.60	8.0	-	-	-	-	-	-	20	0.30	2.0
SNMA 250724:T5315	2.4	-	-	-	-	-	-	90	0.60	8.0	-	-	-	-	-	-	15	0.30	2.0
SNMA 250924:T5305	2.4	-	-	-	-	-	-	95	0.60	8.0	-	-	-	-	-	-	20	0.30	2.0
SNMA 250924:T5315	2.4	-	-	-	-	-	-	90	0.60	8.0	-	-	-	-	-	-	15	0.30	2.0



.NMA.S flat insert is designed for medium machining of Cast irons. It features neutral rake angle and negative, moderate T-land. It's also conditionally suitable for Hard materials.

SNMA 190616S:T5305	1.6	-	-	-	-	-	-	195	0.30	6.0	-	-	-	-	-	-	40	0.15	1.0
SNMA 250924S:T5305	2.4	-	-	-	-	-	-	95	0.60	8.0	-	-	-	-	-	-	20	0.30	2.0



.NMA flat insert is designed for medium machining of Cast irons. It features neutral rake angle without T-land. It's also conditionally suitable for Hard materials.

TNMA 160404:T5305	0.4	-	-	-	-	-	-	220	0.10	1.5	-	-	-	-	-	-	45	0.10	0.3
TNMA 160404:T5315	0.4	-	-	-	-	-	-	190	0.10	1.5	-	-	-	-	-	-	40	0.10	0.3
TNMA 160408:T5305	0.8	-	-	-	-	-	-	205	0.20	1.5	-	-	-	-	-	-	40	0.10	0.7
TNMA 160408:T5315	0.8	-	-	-	-	-	-	180	0.20	1.5	-	-	-	-	-	-	35	0.10	0.7
TNMA 160408:T6310	0.8	-	-	-	-	-	-	90	0.20	1.5	-	-	-	-	-	-	20	0.10	0.7
TNMA 160408:T8415	0.8	-	-	-	-	-	-	135	0.20	1.5	-	-	-	-	-	-	25	0.14	0.5
TNMA 160412:T5305	1.2	-	-	-	-	-	-	215	0.20	1.5	-	-	-	-	-	-	45	0.10	0.9
TNMA 160412:T5315	1.2	-	-	-	-	-	-	190	0.20	1.5	-	-	-	-	-	-	40	0.10	0.9
TNMA 220408:T5305	0.8	-	-	-	-	-	-	195	0.20	2.0	-	-	-	-	-	-	40	0.10	0.7
TNMA 220408:T5315	0.8	-	-	-	-	-	-	175	0.20	2.0	-	-	-	-	-	-	35	0.10	0.7
TNMA 220408:T6310	0.8	-	-	-	-	-	-	90	0.20	2.0	-	-	-	-	-	-	20	0.10	0.7
TNMA 220408:T8415	0.8	-	-	-	-	-	-	130	0.20	2.0	-	-	-	-	-	-	25	0.14	0.5
TNMA 220412:T5305	1.2	-	-	-	-	-	-	205	0.20	2.0	-	-	-	-	-	-	40	0.10	0.9
TNMA 220412:T5315	1.2	-	-	-	-	-	-	185	0.20	2.0	-	-	-	-	-	-	35	0.10	0.9



.NMA.S flat insert is designed for medium machining of Cast irons. It features neutral rake angle and negative, moderate T-land. It's also conditionally suitable for Hard materials.

TNMA 160408S:T5305	0.8	-	-	-	-	-	-	205	0.20	1.5	-	-	-	-	-	-	40	0.10	0.7
--------------------	-----	---	---	---	---	---	---	-----	------	-----	---	---	---	---	---	---	----	------	-----

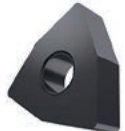

.NMA flat insert is designed for medium machining of Cast irons. It features neutral rake angle without T-land. It's also conditionally suitable for Hard materials.

WNMA 080404:T5305	0.4	-	-	-	-	-	-	235	0.10	4.0	-	-	-	-	-	-	50	0.10	0.3
WNMA 080404:T5315	0.4	-	-	-	-	-	-	200	0.10	4.0	-	-	-	-	-	-	40	0.10	0.3
WNMA 080408:T5305	0.8	-	-	-	-	-	-	220	0.20	4.0	-	-	-	-	-	-	45	0.10	0.7
WNMA 080408:T5315	0.8	-	-	-	-	-	-	190	0.20	4.0	-	-	-	-	-	-	40	0.10	0.7
WNMA 080408:T6310	0.8	-	-	-	-	-	-	100	0.20	4.0	-	-	-	-	-	-	25	0.10	0.7
WNMA 080408:T8415	0.8	-	-	-	-	-	-	145	0.20	4.0	-	-	-	-	-	-	25	0.14	0.5
WNMA 080412:T5305	1.2	-	-	-	-	-	-	195	0.30	4.0	-	-	-	-	-	-	40	0.15	1.0
WNMA 080412:T5315	1.2	-	-	-	-	-	-	180	0.30	4.0	-	-	-	-	-	-	35	0.15	1.0
WNMA 080412:T6310	1.2	-	-	-	-	-	-	95	0.30	4.0	-	-	-	-	-	-	20	0.15	1.0
WNMA 080412:T8415	1.2	-	-	-	-	-	-	135	0.30	4.0	-	-	-	-	-	-	25	0.21	0.5



.NMA.S flat insert is designed for medium machining of Cast irons. It features neutral rake angle and negative, moderate T-land. It's also conditionally suitable for Hard materials.

WNMA 080408S:T5305	0.8	-	-	-	-	-	-	220	0.20	4.0	-	-	-	-	-	-	45	0.10	0.7
--------------------	-----	---	---	---	---	---	---	-----	------	-----	---	---	---	---	---	---	----	------	-----

ROUGHING – NAVIGATOR

RM			<p>RM chip breaker is robust and the first choice for roughing of Steels. It features positive rake angle and stable, wide T-land. It's also suitable for Stainless steels, Cast irons, and conditionally for Super-alloys.</p>
-----------	--	--	--

R			<p>R chip breaker is robust and designed for roughing of Steels and Cast irons. It features slightly positive rake angle and negative/stable, extra-wide double T-land. It's also conditionally suitable for Hard materials.</p>
----------	--	--	---

NRM			<p>NRM chip breaker is versatile and the first choice for roughing of Stainless steels. It features positive rake angle and stable, wide T-land. It's also suitable for Steels and Super-alloys.</p>
------------	--	--	---

KR			<p>KR chip breaker is robust and the first choice for roughing of Cast irons. It features slightly positive rake angle and , wide T-land. It's also suitable for Steels, and conditionally for Hard materials.</p>
-----------	--	--	---

RM

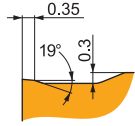

RM chip breaker is robust and the first choice for roughing of Steels. It features positive rake angle and stable, wide T-land. It's also suitable for Stainless steels, Cast irons, and conditionally for Super-alloys.



CNMG

	IC (mm)	D1 (mm)	L (mm)	S (mm)
1204	12.700	5.16	12.90	4.76
1606	15.875	6.35	16.10	6.35
1906	19.050	7.94	19.30	6.35
2509	25.400	9.12	25.80	9.53

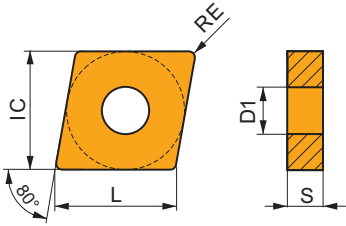

DNMG

	IC (mm)	D1 (mm)	L (mm)	S (mm)
1104	9.525	3.81	11.60	4.76
1504	12.700	5.16	15.50	4.76
1506	12.700	5.16	15.50	6.35

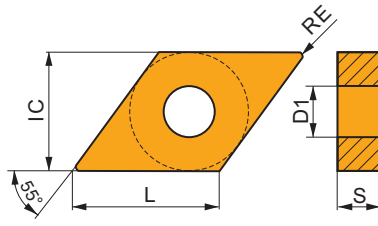

SNMG

	IC (mm)	D1 (mm)	L (mm)	S (mm)
1204	12.700	5.16	12.70	4.76
1506	15.875	6.35	15.88	6.35
1906	19.050	7.94	19.05	6.35
2509	25.400	9.12	25.40	9.53

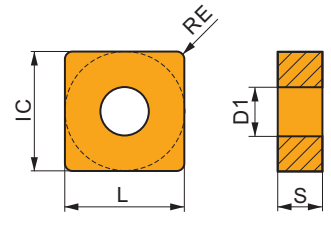

TNMG

	IC (mm)	D1 (mm)	L (mm)	S (mm)
1604	9.525	3.81	16.50	4.76
2204	12.700	5.16	22.00	4.76
2706	15.875	6.35	27.50	6.35
3309	19.050	7.94	33.00	9.53

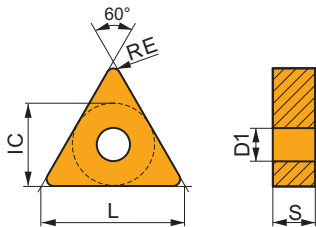

WNMG

	IC (mm)	D1 (mm)	L (mm)	S (mm)
0604	9.525	3.81	6.50	4.76
0804	12.700	5.16	8.70	4.76

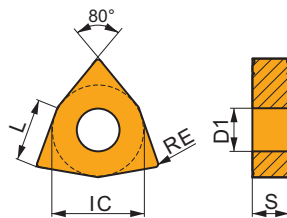

Suitability and starting values for cutting speed (vc), feed (f) and depth of cut (ap). Refer to our Machining Calculator app for further calculations.

Product	RE (mm)	P			M			K			N			S			H		
		vc (m/min)	f (mm/rev)	ap (mm)	vc (m/min)	f (mm/rev)	ap (mm)	vc (m/min)	f (mm/rev)	ap (mm)	vc (m/min)	f (mm/rev)	ap (mm)	vc (m/min)	f (mm/rev)	ap (mm)	vc (m/min)	f (mm/rev)	ap (mm)

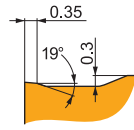

RM chip breaker is robust and the first choice for roughing of Steels. It features positive rake angle and stable, wide T-land. It's also suitable for Stainless steels, Cast irons, and conditionally for Super-alloys.

CNMG 120408E-RM:T5305	0.8	275	0.40	4.0	-	-	-	260	0.40	4.0	-	-	-	-	-	-	-	-
CNMG 120408E-RM:T5315	0.8	250	0.40	4.0	-	-	-	235	0.40	4.0	-	-	-	-	-	-	-	-
CNMG 120408E-RM:T6310	0.8	155	0.40	4.0	110	0.36	4.0	125	0.40	4.0	-	-	-	45	0.28	3.2	-	-
CNMG 120408E-RM:T7325	0.8	180	0.40	4.0	140	0.36	4.0	-	-	-	-	-	-	55	0.28	3.2	-	-
CNMG 120408E-RM:T7335	0.8	165	0.40	4.0	125	0.36	4.0	-	-	-	-	-	-	50	0.28	3.2	-	-
CNMG 120408E-RM:T8315	0.8	165	0.40	4.0	95	0.36	4.0	155	0.40	4.0	-	-	-	40	0.28	3.2	-	-
CNMG 120408E-RM:T8415	0.8	195	0.40	4.0	100	0.36	4.0	180	0.40	4.0	-	-	-	45	0.28	3.2	-	-
CNMG 120408E-RM:T8430	0.8	165	0.40	4.0	90	0.36	4.0	135	0.40	4.0	-	-	-	35	0.28	3.2	-	-
CNMG 120408E-RM:T9310	0.8	240	0.40	4.0	-	-	-	225	0.40	4.0	-	-	-	-	-	-	-	-
CNMG 120408E-RM:T9315	0.8	220	0.40	4.0	-	-	-	205	0.40	4.0	-	-	-	-	-	-	-	-
CNMG 120408E-RM:T9325	0.8	200	0.40	4.0	120	0.36	4.0	190	0.40	4.0	-	-	-	45	0.28	3.2	-	-
CNMG 120408E-RM:T9335	0.8	170	0.40	4.0	100	0.36	4.0	-	-	-	-	-	-	35	0.28	3.2	-	-
CNMG 120408E-RM:T9415	0.8	265	0.40	4.0	-	-	-	250	0.40	4.0	-	-	-	-	-	-	-	-
CNMG 120412E-RM:T5305	1.2	280	0.45	4.0	-	-	-	265	0.45	4.0	-	-	-	-	-	-	-	-
CNMG 120412E-RM:T5315	1.2	250	0.45	4.0	-	-	-	235	0.45	4.0	-	-	-	-	-	-	-	-
CNMG 120412E-RM:T6310	1.2	160	0.45	4.0	115	0.41	4.0	125	0.45	4.0	-	-	-	45	0.32	3.2	-	-
CNMG 120412E-RM:T7325	1.2	180	0.45	4.0	140	0.41	4.0	-	-	-	-	-	-	55	0.32	3.2	-	-
CNMG 120412E-RM:T7335	1.2	170	0.45	4.0	130	0.41	4.0	-	-	-	-	-	-	55	0.32	3.2	-	-
CNMG 120412E-RM:T8415	1.2	200	0.45	4.0	105	0.41	4.0	185	0.45	4.0	-	-	-	45	0.32	3.2	-	-
CNMG 120412E-RM:T8430	1.2	170	0.45	4.0	90	0.41	4.0	135	0.45	4.0	-	-	-	35	0.32	3.2	-	-
CNMG 120412E-RM:T9310	1.2	240	0.45	4.0	-	-	-	225	0.45	4.0	-	-	-	-	-	-	-	-
CNMG 120412E-RM:T9315	1.2	220	0.45	4.0	-	-	-	205	0.45	4.0	-	-	-	-	-	-	-	-
CNMG 120412E-RM:T9325	1.2	200	0.45	4.0	120	0.41	4.0	190	0.45	4.0	-	-	-	45	0.32	3.2	-	-
CNMG 120412E-RM:T9335	1.2	175	0.45	4.0	105	0.41	4.0	-	-	-	-	-	-	35	0.32	3.2	-	-
CNMG 120412E-RM:T9415	1.2	270	0.45	4.0	-	-	-	255	0.45	4.0	-	-	-	-	-	-	-	-
CNMG 120416E-RM:T5315	1.6	255	0.50	4.0	-	-	-	240	0.50	4.0	-	-	-	-	-	-	-	-
CNMG 120416E-RM:T7335	1.6	175	0.50	4.0	135	0.45	4.0	-	-	-	-	-	-	55	0.35	3.2	-	-
CNMG 120416E-RM:T8430	1.6	170	0.50	4.0	90	0.45	4.0	135	0.50	4.0	-	-	-	35	0.35	3.2	-	-
CNMG 120416E-RM:T9325	1.6	205	0.50	4.0	120	0.45	4.0	190	0.50	4.0	-	-	-	45	0.35	3.2	-	-
CNMG 120416E-RM:T9335	1.6	175	0.50	4.0	105	0.45	4.0	-	-	-	-	-	-	35	0.35	3.2	-	-
CNMG 120416E-RM:T9415	1.6	275	0.50	4.0	-	-	-	260	0.50	4.0	-	-	-	-	-	-	-	-
CNMG 160608E-RM:T5305	0.8	265	0.40	6.0	-	-	-	250	0.40	6.0	-	-	-	-	-	-	-	-
CNMG 160608E-RM:T5315	0.8	240	0.40	6.0	-	-	-	225	0.40	6.0	-	-	-	-	-	-	-	-
CNMG 160608E-RM:T8430	0.8	155	0.40	6.0	85	0.36	6.0	130	0.40	6.0	-	-	-	30	0.28	4.8	-	-
CNMG 160608E-RM:T9325	0.8	190	0.40	6.0	110	0.36	6.0	180	0.40	6.0	-	-	-	40	0.28	4.8	-	-
CNMG 160608E-RM:T9335	0.8	165	0.40	6.0	95	0.36	6.0	-	-	-	-	-	-	35	0.28	4.8	-	-
CNMG 160608E-RM:T9415	0.8	255	0.40	6.0	-	-	-	240	0.40	6.0	-	-	-	-	-	-	-	-
CNMG 160612E-RM:T5305	1.2	270	0.45	6.0	-	-	-	255	0.45	6.0	-	-	-	-	-	-	-	-
CNMG 160612E-RM:T6310	1.2	155	0.45	6.0	110	0.41	6.0	125	0.45	6.0	-	-	-	45	0.32	4.8	-	-
CNMG 160612E-RM:T7325	1.2	170	0.45	6.0	130	0.41	6.0	-	-	-	-	-	-	55	0.32	4.8	-	-
CNMG 160612E-RM:T7335	1.2	165	0.45	6.0	125	0.41	6.0	-	-	-	-	-	-	50	0.32	4.8	-	-
CNMG 160612E-RM:T8415	1.2	195	0.45	6.0	100	0.41	6.0	180	0.45	6.0	-	-	-	45	0.32	4.8	-	-
CNMG 160612E-RM:T8430	1.2	155	0.45	6.0	85	0.41	6.0	130	0.45	6.0	-	-	-	30	0.32	4.8	-	-
CNMG 160612E-RM:T9310	1.2	230	0.45	6.0	-	-	-	215	0.45	6.0	-	-	-	-	-	-	-	-
CNMG 160612E-RM:T9315	1.2	215	0.45	6.0	-	-	-	200	0.45	6.0	-	-	-	-	-	-	-	-
CNMG 160612E-RM:T9325	1.2	195	0.45	6.0	115	0.41	6.0	185	0.45	6.0	-	-	-	40	0.32	4.8	-	-
CNMG 160612E-RM:T9335	1.2	165	0.45	6.0	95	0.41	6.0	-	-	-	-	-	-	35	0.32	4.8	-	-
CNMG 160612E-RM:T9415	1.2	260	0.45	6.0	-	-	-	245	0.45	6.0	-	-	-	-	-	-	-	-
CNMG 160616E-RM:T5305	1.6	270	0.50	6.0	-	-	-	255	0.50	6.0	-	-	-	-	-	-	-	-
CNMG 160616E-RM:T5315	1.6	245	0.50	6.0	-	-	-	230	0.50	6.0	-	-	-	-	-	-	-	-
CNMG 160616E-RM:T7325	1.6	175	0.50	6.0	135	0.45	6.0	-	-	-	-	-	-	55	0.35	4.8	-	-
CNMG 160616E-RM:T7335	1.6	165	0.50	6.0	125	0.45	6.0	-	-	-	-	-	-	50	0.35	4.8	-	-
CNMG 160616E-RM:T9310	1.6	225	0.50	6.0	-	-	-	210	0.50	6.0	-	-	-	-	-	-	-	-
CNMG 160616E-RM:T9315	1.6	215	0.50	6.0	-	-	-	200	0.50	6.0	-	-	-	-	-	-	-	-
CNMG 160616E-RM:T9325	1.6	190	0.50	6.0	110	0.45	6.0	180	0.50	6.0	-	-	-	40	0.35	4.8	-	-
CNMG 160616E-RM:T9335	1.6	165	0.50	6.0	95	0.45	6.0	-	-	-	-	-	-	35	0.35	4.8	-	-
CNMG 160616E-RM:T9415	1.6	265	0.50	6.0	-	-	-	250	0.50	6.0	-	-	-	-	-	-	-	-

Suitability and starting values for cutting speed (vc), feed (f) and depth of cut (ap). Refer to our Machining Calculator app for further calculations.

Product	RE (mm)	P			M			K			N			S			H		
		vc (m/min)	f (mm/rev)	ap (mm)	vc (m/min)	f (mm/rev)	ap (mm)	vc (m/min)	f (mm/rev)	ap (mm)	vc (m/min)	f (mm/rev)	ap (mm)	vc (m/min)	f (mm/rev)	ap (mm)	vc (m/min)	f (mm/rev)	ap (mm)

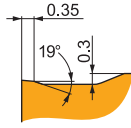

RM chip breaker is robust and the first choice for roughing of Steels. It features positive rake angle and stable, wide T-land. It's also suitable for Stainless steels, Cast irons, and conditionally for Super-alloys.

CNMG 190608E-RM:T5305	0.8	260	0.40	7.5	-	-	-	245	0.40	7.5	-	-	-	-	-	-	-	-
CNMG 190608E-RM:T5315	0.8	230	0.40	7.5	-	-	-	215	0.40	7.5	-	-	-	-	-	-	-	-
CNMG 190608E-RM:T7335	0.8	155	0.40	7.5	120	0.36	7.5	-	-	-	50	0.28	6.0	-	-	-	-	-
CNMG 190608E-RM:T9325	0.8	190	0.40	7.5	110	0.36	7.5	180	0.40	7.5	40	0.28	6.0	-	-	-	-	-
CNMG 190608E-RM:T9335	0.8	160	0.40	7.5	95	0.36	7.5	-	-	-	35	0.28	6.0	-	-	-	-	-
CNMG 190608E-RM:T9415	0.8	250	0.40	7.5	-	-	-	235	0.40	7.5	-	-	-	-	-	-	-	-
CNMG 190612E-RM:T5305	1.2	260	0.45	7.5	-	-	-	245	0.45	7.5	-	-	-	-	-	-	-	-
CNMG 190612E-RM:T5315	1.2	240	0.45	7.5	-	-	-	225	0.45	7.5	-	-	-	-	-	-	-	-
CNMG 190612E-RM:T6310	1.2	155	0.45	7.5	110	0.41	7.5	125	0.45	7.5	45	0.32	6.0	-	-	-	-	-
CNMG 190612E-RM:T7325	1.2	170	0.45	7.5	130	0.41	7.5	-	-	-	55	0.32	6.0	-	-	-	-	-
CNMG 190612E-RM:T7335	1.2	160	0.45	7.5	120	0.41	7.5	-	-	-	50	0.32	6.0	-	-	-	-	-
CNMG 190612E-RM:T8415	1.2	195	0.45	7.5	100	0.41	7.5	180	0.45	7.5	45	0.32	6.0	-	-	-	-	-
CNMG 190612E-RM:T8430	1.2	150	0.45	7.5	80	0.41	7.5	125	0.45	7.5	30	0.32	6.0	-	-	-	-	-
CNMG 190612E-RM:T9325	1.2	185	0.45	7.5	110	0.41	7.5	175	0.45	7.5	40	0.32	6.0	-	-	-	-	-
CNMG 190612E-RM:T9335	1.2	165	0.45	7.5	95	0.41	7.5	-	-	-	35	0.32	6.0	-	-	-	-	-
CNMG 190612E-RM:T9415	1.2	250	0.45	7.5	-	-	-	235	0.45	7.5	-	-	-	-	-	-	-	-
CNMG 190616E-RM:T5305	1.6	265	0.50	7.5	-	-	-	250	0.50	7.5	-	-	-	-	-	-	-	-
CNMG 190616E-RM:T6310	1.6	155	0.50	7.5	110	0.45	7.5	125	0.50	7.5	45	0.35	6.0	-	-	-	-	-
CNMG 190616E-RM:T7325	1.6	175	0.50	7.5	135	0.45	7.5	-	-	-	55	0.35	6.0	-	-	-	-	-
CNMG 190616E-RM:T7335	1.6	160	0.50	7.5	120	0.45	7.5	-	-	-	50	0.35	6.0	-	-	-	-	-
CNMG 190616E-RM:T8415	1.6	195	0.50	7.5	100	0.45	7.5	180	0.50	7.5	45	0.35	6.0	-	-	-	-	-
CNMG 190616E-RM:T8430	1.6	150	0.50	7.5	80	0.45	7.5	125	0.50	7.5	30	0.35	6.0	-	-	-	-	-
CNMG 190616E-RM:T9315	1.6	210	0.50	7.5	-	-	-	195	0.50	7.5	-	-	-	-	-	-	-	-
CNMG 190616E-RM:T9325	1.6	190	0.50	7.5	110	0.45	7.5	180	0.50	7.5	40	0.35	6.0	-	-	-	-	-
CNMG 190616E-RM:T9335	1.6	160	0.50	7.5	95	0.45	7.5	-	-	-	35	0.35	6.0	-	-	-	-	-
CNMG 190616E-RM:T9415	1.6	255	0.50	7.5	-	-	-	240	0.50	7.5	-	-	-	-	-	-	-	-
CNMG 250924E-RM:T7325	2.4	105	0.80	12.0	80	0.72	12.0	-	-	-	30	0.56	9.6	-	-	-	-	-
CNMG 250924E-RM:T7335	2.4	100	0.80	12.0	75	0.72	12.0	-	-	-	30	0.56	9.6	-	-	-	-	-
CNMG 250924E-RM:T9226	2.4	90	0.80	12.0	50	0.72	12.0	85	0.80	12.0	15	0.56	9.6	-	-	-	-	-
CNMG 250924E-RM:T9325	2.4	105	0.80	12.0	60	0.72	12.0	95	0.80	12.0	20	0.56	9.6	-	-	-	-	-
CNMG 250924E-RM:T9335	2.4	85	0.80	12.0	50	0.72	12.0	-	-	-	15	0.56	9.6	-	-	-	-	-
CNMG 250924E-RM:T9415	2.4	125	0.80	12.0	-	-	-	115	0.80	12.0	-	-	-	-	-	-	-	-

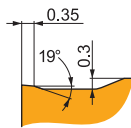

RM chip breaker is robust and the first choice for roughing of Steels. It features positive rake angle and stable, wide T-land. It's also suitable for Stainless steels, Cast irons, and conditionally for Super-alloys.

DNMG 110408E-RM:T9325	0.8	170	0.40	2.0	100	0.36	2.0	160	0.40	2.0	35	0.28	1.6	-	-	-	-	-
DNMG 110408E-RM:T9415	0.8	230	0.40	2.0	-	-	-	215	0.40	2.0	-	-	-	-	-	-	-	-
DNMG 110412E-RM:T9325	1.2	205	0.30	2.0	120	0.27	2.0	190	0.30	2.0	45	0.21	1.6	-	-	-	-	-
DNMG 110412E-RM:T9415	1.2	265	0.30	2.0	-	-	-	250	0.30	2.0	-	-	-	-	-	-	-	-
DNMG 150408E-RM:T9325	0.8	165	0.40	3.0	95	0.36	3.0	155	0.40	3.0	35	0.28	2.4	-	-	-	-	-
DNMG 150408E-RM:T9335	0.8	140	0.40	3.0	80	0.36	3.0	-	-	-	30	0.28	2.4	-	-	-	-	-
DNMG 150408E-RM:T9415	0.8	220	0.40	3.0	-	-	-	205	0.40	3.0	-	-	-	-	-	-	-	-
DNMG 150412E-RM:T7325	1.2	155	0.40	3.0	120	0.36	3.0	-	-	-	50	0.28	2.4	-	-	-	-	-
DNMG 150412E-RM:T9325	1.2	170	0.40	3.0	100	0.36	3.0	160	0.40	3.0	35	0.28	2.4	-	-	-	-	-
DNMG 150412E-RM:T9335	1.2	150	0.40	3.0	90	0.36	3.0	-	-	-	30	0.28	2.4	-	-	-	-	-
DNMG 150412E-RM:T9415	1.2	230	0.40	3.0	-	-	-	215	0.40	3.0	-	-	-	-	-	-	-	-
DNMG 150608E-RM:T5305	0.8	230	0.40	3.0	-	-	-	215	0.40	3.0	-	-	-	-	-	-	-	-
DNMG 150608E-RM:T5315	0.8	205	0.40	3.0	-	-	-	190	0.40	3.0	-	-	-	-	-	-	-	-
DNMG 150608E-RM:T7325	0.8	145	0.40	3.0	110	0.36	3.0	-	-	-	45	0.28	2.4	-	-	-	-	-
DNMG 150608E-RM:T7335	0.8	135	0.40	3.0	105	0.36	3.0	-	-	-	40	0.28	2.4	-	-	-	-	-
DNMG 150608E-RM:T8315	0.8	135	0.40	3.0	80	0.36	3.0	125	0.40	3.0	30	0.28	2.4	-	-	-	-	-
DNMG 150608E-RM:T8415	0.8	160	0.40	3.0	85	0.36	3.0	145	0.40	3.0	35	0.28	2.4	-	-	-	-	-
DNMG 150608E-RM:T8430	0.8	135	0.40	3.0	75	0.36	3.0	110	0.40	3.0	25	0.28	2.4	-	-	-	-	-
DNMG 150608E-RM:T9325	0.8	165	0.40	3.0	95	0.36	3.0	155	0.40	3.0	35	0.28	2.4	-	-	-	-	-
DNMG 150608E-RM:T9335	0.8	140	0.40	3.0	80	0.36	3.0	-	-	-	30	0.28	2.4	-	-	-	-	-
DNMG 150608E-RM:T9415	0.8	220	0.40	3.0	-	-	-	205	0.40	3.0	-	-	-	-	-	-	-	-

Suitability and starting values for cutting speed (vc), feed (f) and depth of cut (ap). Refer to our Machining Calculator app for further calculations.

Product	RE (mm)	P			M			K			N			S			H		
		vc (m/min)	f (mm/rev)	ap (mm)	vc (m/min)	f (mm/rev)	ap (mm)	vc (m/min)	f (mm/rev)	ap (mm)	vc (m/min)	f (mm/rev)	ap (mm)	vc (m/min)	f (mm/rev)	ap (mm)	vc (m/min)	f (mm/rev)	ap (mm)

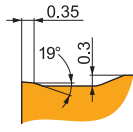

RM chip breaker is robust and the first choice for roughing of Steels. It features positive rake angle and stable, wide T-land. It's also suitable for Stainless steels, Cast irons, and conditionally for Super-alloys.

DNMG 150612E-RM:T5305	●	1.2	240	0.40	3.0	—	—	—	225	0.40	3.0	—	—	—	—	—	—	—	—
DNMG 150612E-RM:T5315	●	1.2	215	0.40	3.0	—	—	—	200	0.40	3.0	—	—	—	—	—	—	—	—
DNMG 150612E-RM:T7325	●	1.2	155	0.40	3.0	120	0.36	3.0	—	—	—	50	0.28	2.4	—	—	—	—	—
DNMG 150612E-RM:T8430	●	1.2	140	0.40	3.0	75	0.36	3.0	115	0.40	3.0	—	—	—	30	0.28	2.4	—	—
DNMG 150612E-RM:T9325	●	1.2	170	0.40	3.0	100	0.36	3.0	160	0.40	3.0	—	—	—	35	0.28	2.4	—	—
DNMG 150612E-RM:T9335	●	1.2	150	0.40	3.0	90	0.36	3.0	—	—	—	30	0.28	2.4	—	—	—	—	—
DNMG 150612E-RM:T9415	●	1.2	230	0.40	3.0	—	—	—	215	0.40	3.0	—	—	—	—	—	—	—	—
DNMG 150616E-RM:T5315	●	1.6	225	0.40	3.0	—	—	—	210	0.40	3.0	—	—	—	—	—	—	—	—
DNMG 150616E-RM:T9325	●	1.6	180	0.40	3.0	105	0.36	3.0	170	0.40	3.0	40	0.28	2.4	—	—	—	—	—
DNMG 150616E-RM:T9335	●	1.6	155	0.40	3.0	90	0.36	3.0	—	—	—	30	0.28	2.4	—	—	—	—	—
DNMG 150616E-RM:T9415	●	1.6	245	0.40	3.0	—	—	—	230	0.40	3.0	—	—	—	—	—	—	—	—

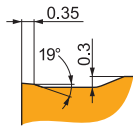
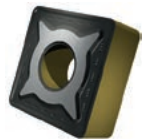

RM chip breaker is robust and the first choice for roughing of Steels. It features positive rake angle and stable, wide T-land. It's also suitable for Stainless steels, Cast irons, and conditionally for Super-alloys.

SNMG 120408E-RM:T5305	●	0.8	290	0.40	4.0	—	—	—	275	0.40	4.0	—	—	—	—	—	—	—	—
SNMG 120408E-RM:T6310	●	0.8	165	0.40	4.0	115	0.36	4.0	130	0.40	4.0	45	0.28	3.2	—	—	—	—	—
SNMG 120408E-RM:T7325	●	0.8	185	0.40	4.0	140	0.36	4.0	—	—	—	60	0.28	3.2	—	—	—	—	—
SNMG 120408E-RM:T7335	●	0.8	175	0.40	4.0	135	0.36	4.0	—	—	—	55	0.28	3.2	—	—	—	—	—
SNMG 120408E-RM:T8315	●	0.8	175	0.40	4.0	105	0.36	4.0	165	0.40	4.0	40	0.28	3.2	—	—	—	—	—
SNMG 120408E-RM:T8415	●	0.8	210	0.40	4.0	110	0.36	4.0	190	0.40	4.0	45	0.28	3.2	—	—	—	—	—
SNMG 120408E-RM:T8430	●	0.8	175	0.40	4.0	95	0.36	4.0	140	0.40	4.0	35	0.28	3.2	—	—	—	—	—
SNMG 120408E-RM:T9325	●	0.8	210	0.40	4.0	125	0.36	4.0	195	0.40	4.0	45	0.28	3.2	—	—	—	—	—
SNMG 120408E-RM:T9335	●	0.8	180	0.40	4.0	105	0.36	4.0	—	—	—	40	0.28	3.2	—	—	—	—	—
SNMG 120408E-RM:T9415	●	0.8	280	0.40	4.0	—	—	—	265	0.40	4.0	—	—	—	—	—	—	—	—
SNMG 120412E-RM:T6310	●	1.2	165	0.45	4.0	115	0.41	4.0	130	0.45	4.0	45	0.32	3.2	—	—	—	—	—
SNMG 120412E-RM:T7325	●	1.2	190	0.45	4.0	145	0.41	4.0	—	—	—	60	0.32	3.2	—	—	—	—	—
SNMG 120412E-RM:T7335	●	1.2	180	0.45	4.0	140	0.41	4.0	—	—	—	55	0.32	3.2	—	—	—	—	—
SNMG 120412E-RM:T8415	●	1.2	215	0.45	4.0	110	0.41	4.0	195	0.45	4.0	45	0.32	3.2	—	—	—	—	—
SNMG 120412E-RM:T9325	●	1.2	210	0.45	4.0	125	0.41	4.0	195	0.45	4.0	45	0.32	3.2	—	—	—	—	—
SNMG 120412E-RM:T9335	●	1.2	185	0.45	4.0	110	0.41	4.0	—	—	—	40	0.32	3.2	—	—	—	—	—
SNMG 120412E-RM:T9415	●	1.2	280	0.45	4.0	—	—	—	265	0.45	4.0	—	—	—	—	—	—	—	—
SNMG 120416E-RM:T8430	●	1.6	175	0.50	4.0	95	0.45	4.0	140	0.50	4.0	35	0.35	3.2	—	—	—	—	—
SNMG 120416E-RM:T9325	●	1.6	215	0.50	4.0	125	0.45	4.0	200	0.50	4.0	45	0.35	3.2	—	—	—	—	—
SNMG 120416E-RM:T9335	●	1.6	180	0.50	4.0	105	0.45	4.0	—	—	—	40	0.35	3.2	—	—	—	—	—
SNMG 120416E-RM:T9415	●	1.6	290	0.50	4.0	—	—	—	275	0.50	4.0	—	—	—	—	—	—	—	—
SNMG 150612E-RM:T6310	●	1.2	165	0.45	5.0	115	0.41	5.0	130	0.45	5.0	45	0.32	4.0	—	—	—	—	—
SNMG 150612E-RM:T7325	●	1.2	185	0.45	5.0	140	0.41	5.0	—	—	—	60	0.32	4.0	—	—	—	—	—
SNMG 150612E-RM:T8415	●	1.2	215	0.45	5.0	110	0.41	5.0	195	0.45	5.0	45	0.32	4.0	—	—	—	—	—
SNMG 150612E-RM:T9325	●	1.2	205	0.45	5.0	120	0.41	5.0	190	0.45	5.0	45	0.32	4.0	—	—	—	—	—
SNMG 150612E-RM:T9335	●	1.2	180	0.45	5.0	105	0.41	5.0	—	—	—	40	0.32	4.0	—	—	—	—	—
SNMG 150612E-RM:T9415	●	1.2	275	0.45	5.0	—	—	—	260	0.45	5.0	—	—	—	—	—	—	—	—
SNMG 150616E-RM:T7335	●	1.6	175	0.50	5.0	135	0.45	5.0	—	—	—	55	0.35	4.0	—	—	—	—	—
SNMG 150616E-RM:T9325	●	1.6	205	0.50	5.0	120	0.45	5.0	190	0.50	5.0	45	0.35	4.0	—	—	—	—	—
SNMG 150616E-RM:T9335	●	1.6	180	0.50	5.0	105	0.45	5.0	—	—	—	40	0.35	4.0	—	—	—	—	—
SNMG 150616E-RM:T9415	●	1.6	285	0.50	5.0	—	—	—	270	0.50	5.0	—	—	—	—	—	—	—	—
SNMG 190612E-RM:T5305	●	1.2	275	0.45	7.0	—	—	—	260	0.45	7.0	—	—	—	—	—	—	—	—
SNMG 190612E-RM:T5315	●	1.2	250	0.45	7.0	—	—	—	235	0.45	7.0	—	—	—	—	—	—	—	—
SNMG 190612E-RM:T7325	●	1.2	180	0.45	7.0	140	0.41	7.0	—	—	—	55	0.32	5.6	—	—	—	—	—
SNMG 190612E-RM:T7335	●	1.2	165	0.45	7.0	125	0.41	7.0	—	—	—	50	0.32	5.6	—	—	—	—	—
SNMG 190612E-RM:T9325	●	1.2	195	0.45	7.0	115	0.41	7.0	185	0.45	7.0	40	0.32	5.6	—	—	—	—	—
SNMG 190612E-RM:T9335	●	1.2	175	0.45	7.0	105	0.41	7.0	—	—	—	35	0.32	5.6	—	—	—	—	—
SNMG 190612E-RM:T9415	●	1.2	270	0.45	7.0	—	—	—	255	0.45	7.0	—	—	—	—	—	—	—	—

Suitability and starting values for cutting speed (vc), feed (f) and depth of cut (ap). Refer to our Machining Calculator app for further calculations.

Product	RE (mm)	P			M			K			N			S			H		
		vc (m/min)	f (mm/rev)	ap (mm)	vc (m/min)	f (mm/rev)	ap (mm)	vc (m/min)	f (mm/rev)	ap (mm)	vc (m/min)	f (mm/rev)	ap (mm)	vc (m/min)	f (mm/rev)	ap (mm)	vc (m/min)	f (mm/rev)	ap (mm)

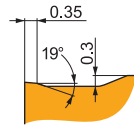
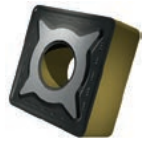

RM chip breaker is robust and the first choice for roughing of Steels. It features positive rake angle and stable, wide T-land. It's also suitable for Stainless steels, Cast irons, and conditionally for Super-alloys.

SNMG 190616E-RM-T5305	1.6	285	0.50	7.0	-	-	-	270	0.50	7.0	-	-	-	-	-	-	-	-	-
SNMG 190616E-RM-T6310	1.6	160	0.50	7.0	115	0.45	7.0	125	0.50	7.0	-	-	-	45	0.35	5.6	-	-	-
SNMG 190616E-RM-T7335	1.6	170	0.50	7.0	130	0.45	7.0	-	-	-	-	-	-	55	0.35	5.6	-	-	-
SNMG 190616E-RM-T8415	1.6	210	0.50	7.0	110	0.45	7.0	190	0.50	7.0	-	-	-	45	0.35	5.6	-	-	-
SNMG 190616E-RM-T8430	1.6	165	0.50	7.0	90	0.45	7.0	135	0.50	7.0	-	-	-	35	0.35	5.6	-	-	-
SNMG 190616E-RM-T9325	1.6	200	0.50	7.0	120	0.45	7.0	190	0.50	7.0	-	-	-	45	0.35	5.6	-	-	-
SNMG 190616E-RM-T9335	1.6	175	0.50	7.0	105	0.45	7.0	-	-	-	-	-	-	35	0.35	5.6	-	-	-
SNMG 190616E-RM-T9415	1.6	270	0.50	7.0	-	-	-	255	0.50	7.0	-	-	-	-	-	-	-	-	-
SNMG 250924E-RM-T7325	2.4	110	0.80	12.0	85	0.72	12.0	-	-	-	-	-	-	35	0.56	9.6	-	-	-
SNMG 250924E-RM-T7335	2.4	105	0.80	12.0	80	0.72	12.0	-	-	-	-	-	-	30	0.56	9.6	-	-	-
SNMG 250924E-RM-T9226	2.4	95	0.80	12.0	55	0.72	12.0	90	0.80	12.0	-	-	-	20	0.56	9.6	-	-	-
SNMG 250924E-RM-T9315	2.4	125	0.80	12.0	-	-	-	115	0.80	12.0	-	-	-	-	-	-	-	-	-
SNMG 250924E-RM-T9325	2.4	110	0.80	12.0	65	0.72	12.0	100	0.80	12.0	-	-	-	20	0.56	9.6	-	-	-
SNMG 250924E-RM-T9335	2.4	90	0.80	12.0	50	0.72	12.0	-	-	-	-	-	-	20	0.56	9.6	-	-	-
SNMG 250924E-RM-T9415	2.4	130	0.80	12.0	-	-	-	120	0.80	12.0	-	-	-	-	-	-	-	-	-

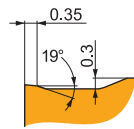
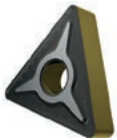

RM chip breaker is robust and the first choice for roughing of Steels. It features positive rake angle and stable, wide T-land. It's also suitable for Stainless steels, Cast irons, and conditionally for Super-alloys.

TNMG 160408E-RM-T5305	0.8	245	0.40	3.0	-	-	-	230	0.40	3.0	-	-	-	-	-	-	-	-	-
TNMG 160408E-RM-T5315	0.8	215	0.40	3.0	-	-	-	200	0.40	3.0	-	-	-	-	-	-	-	-	-
TNMG 160408E-RM-T7325	0.8	155	0.40	3.0	120	0.36	3.0	-	-	-	-	-	-	50	0.28	2.4	-	-	-
TNMG 160408E-RM-T7335	0.8	145	0.40	3.0	110	0.36	3.0	-	-	-	-	-	-	45	0.28	2.4	-	-	-
TNMG 160408E-RM-T9325	0.8	175	0.40	3.0	105	0.36	3.0	165	0.40	3.0	-	-	-	35	0.28	2.4	-	-	-
TNMG 160408E-RM-T9335	0.8	150	0.40	3.0	90	0.36	3.0	-	-	-	-	-	-	30	0.28	2.4	-	-	-
TNMG 160408E-RM-T9415	0.8	235	0.40	3.0	-	-	-	220	0.40	3.0	-	-	-	-	-	-	-	-	-
TNMG 160412E-RM-T5305	1.2	255	0.40	3.0	-	-	-	240	0.40	3.0	-	-	-	-	-	-	-	-	-
TNMG 160412E-RM-T7335	1.2	155	0.40	3.0	120	0.36	3.0	-	-	-	-	-	-	50	0.28	2.4	-	-	-
TNMG 160412E-RM-T8430	1.2	150	0.40	3.0	80	0.36	3.0	125	0.40	3.0	-	-	-	30	0.28	2.4	-	-	-
TNMG 160412E-RM-T9325	1.2	185	0.40	3.0	110	0.36	3.0	175	0.40	3.0	-	-	-	40	0.28	2.4	-	-	-
TNMG 160412E-RM-T9335	1.2	160	0.40	3.0	95	0.36	3.0	-	-	-	-	-	-	35	0.28	2.4	-	-	-
TNMG 160412E-RM-T9415	1.2	245	0.40	3.0	-	-	-	230	0.40	3.0	-	-	-	-	-	-	-	-	-
TNMG 220408E-RM-T7325	0.8	150	0.40	4.0	115	0.36	4.0	-	-	-	-	-	-	45	0.28	3.2	-	-	-
TNMG 220408E-RM-T9325	0.8	170	0.40	4.0	100	0.36	4.0	160	0.40	4.0	-	-	-	35	0.28	3.2	-	-	-
TNMG 220408E-RM-T9335	0.8	145	0.40	4.0	85	0.36	4.0	-	-	-	-	-	-	30	0.28	3.2	-	-	-
TNMG 220408E-RM-T9415	0.8	225	0.40	4.0	-	-	-	210	0.40	4.0	-	-	-	-	-	-	-	-	-
TNMG 220412E-RM-T5305	1.2	245	0.40	4.0	-	-	-	230	0.40	4.0	-	-	-	-	-	-	-	-	-
TNMG 220412E-RM-T7325	1.2	160	0.40	4.0	120	0.36	4.0	-	-	-	-	-	-	50	0.28	3.2	-	-	-
TNMG 220412E-RM-T7335	1.2	150	0.40	4.0	115	0.36	4.0	-	-	-	-	-	-	45	0.28	3.2	-	-	-
TNMG 220412E-RM-T9325	1.2	180	0.40	4.0	105	0.36	4.0	170	0.40	4.0	-	-	-	40	0.28	3.2	-	-	-
TNMG 220412E-RM-T9335	1.2	155	0.40	4.0	90	0.36	4.0	-	-	-	-	-	-	30	0.28	3.2	-	-	-
TNMG 220412E-RM-T9415	1.2	235	0.40	4.0	-	-	-	220	0.40	4.0	-	-	-	-	-	-	-	-	-
TNMG 220416E-RM-T7325	1.6	165	0.40	4.0	125	0.36	4.0	-	-	-	-	-	-	50	0.28	3.2	-	-	-
TNMG 220416E-RM-T9325	1.6	185	0.40	4.0	110	0.36	4.0	175	0.40	4.0	-	-	-	40	0.28	3.2	-	-	-
TNMG 220416E-RM-T9335	1.6	160	0.40	4.0	95	0.36	4.0	-	-	-	-	-	-	35	0.28	3.2	-	-	-
TNMG 220416E-RM-T9415	1.6	250	0.40	4.0	-	-	-	235	0.40	4.0	-	-	-	-	-	-	-	-	-
TNMG 270612E-RM-T7325	1.2	110	0.40	6.0	85	0.36	6.0	-	-	-	-	-	-	35	0.28	4.8	-	-	-
TNMG 270612E-RM-T9325	1.2	120	0.40	6.0	70	0.36	6.0	110	0.40	6.0	-	-	-	25	0.28	4.8	-	-	-
TNMG 270616E-RM-T7325	1.6	115	0.40	6.0	85	0.36	6.0	-	-	-	-	-	-	35	0.28	4.8	-	-	-
TNMG 270616E-RM-T9325	1.6	125	0.40	6.0	75	0.36	6.0	115	0.40	6.0	-	-	-	25	0.28	4.8	-	-	-
TNMG 270616E-RM-T9335	1.6	100	0.40	6.0	60	0.36	6.0	-	-	-	-	-	-	20	0.28	4.8	-	-	-
TNMG 270616E-RM-T9415	1.6	140	0.40	6.0	-	-	-	130	0.40	6.0	-	-	-	-	-	-	-	-	-
TNMG 270624E-RM-T7325	2.4	115	0.50	6.0	85	0.45	6.0	-	-	-	-	-	-	35	0.35	4.8	-	-	-
TNMG 270624E-RM-T9325	2.4	120	0.50	6.0	70	0.45	6.0	110	0.50	6.0	-	-	-	25	0.35	4.8	-	-	-
TNMG 270624E-RM-T9335	2.4	95	0.50	6.0	55	0.45	6.0	-	-	-	-	-	-	20	0.35	4.8	-	-	-
TNMG 270632E-RM-T9335	3.2	90	0.60	6.0	50	0.54	6.0	-	-	-	-	-	-	20	0.42	4.8	-	-	-
TNMG 330924E-RM-T9226	2.4	100	0.50	10.0	60	0.45	10.0	95	0.50	10.0	-	-	-	20	0.35	8.0	-	-	-
TNMG 330924E-RM-T9335	2.4	90	0.50	10.0	50	0.45	10.0	-	-	-	-	-	-	20	0.35	8.0	-	-	-

Suitability and starting values for cutting speed (vc), feed (f) and depth of cut (ap). Refer to our Machining Calculator app for further calculations.

Product	RE (mm)	P			M			K			N			S			H		
		vc (m/min)	f (mm/rev)	ap (mm)	vc (m/min)	f (mm/rev)	ap (mm)	vc (m/min)	f (mm/rev)	ap (mm)	vc (m/min)	f (mm/rev)	ap (mm)	vc (m/min)	f (mm/rev)	ap (mm)	vc (m/min)	f (mm/rev)	ap (mm)

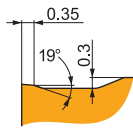
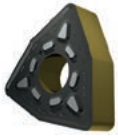

RM chip breaker is robust and the first choice for roughing of Steels. It features positive rake angle and stable, wide T-land. It's also suitable for Stainless steels, Cast irons, and conditionally for Super-alloys.

WNMG 060412E-RM-T9315	1.2	230	0.45	3.0	-	-	-	215	0.45	3.0	-	-	-	-	-	-	-	-
WNMG 060412E-RM-T9325	1.2	230	0.45	1.2	135	0.41	1.2	215	0.45	1.2	-	-	-	50	0.32	1.0	-	-
WNMG 060412E-RM-T9415	1.2	280	0.45	3.0	-	-	-	265	0.45	3.0	-	-	-	-	-	-	-	-
WNMG 080408E-RM-T5305	0.8	275	0.40	4.0	-	-	-	260	0.40	4.0	-	-	-	-	-	-	-	-
WNMG 080408E-RM-T5315	0.8	250	0.40	4.0	-	-	-	235	0.40	4.0	-	-	-	-	-	-	-	-
WNMG 080408E-RM-T7325	0.8	180	0.40	4.0	140	0.36	4.0	-	-	-	-	-	-	55	0.28	3.2	-	-
WNMG 080408E-RM-T7335	0.8	165	0.40	4.0	125	0.36	4.0	-	-	-	-	-	-	50	0.28	3.2	-	-
WNMG 080408E-RM-T8315	0.8	165	0.40	4.0	95	0.36	4.0	155	0.40	4.0	-	-	-	40	0.28	3.2	-	-
WNMG 080408E-RM-T8415	0.8	195	0.40	4.0	100	0.36	4.0	180	0.40	4.0	-	-	-	45	0.28	3.2	-	-
WNMG 080408E-RM-T8430	0.8	165	0.40	4.0	90	0.36	4.0	135	0.40	4.0	-	-	-	35	0.28	3.2	-	-
WNMG 080408E-RM-T9310	0.8	240	0.40	4.0	-	-	-	225	0.40	4.0	-	-	-	-	-	-	-	-
WNMG 080408E-RM-T9315	0.8	220	0.40	4.0	-	-	-	205	0.40	4.0	-	-	-	-	-	-	-	-
WNMG 080408E-RM-T9325	0.8	200	0.40	4.0	120	0.36	4.0	190	0.40	4.0	-	-	-	45	0.28	3.2	-	-
WNMG 080408E-RM-T9335	0.8	170	0.40	4.0	100	0.36	4.0	-	-	-	-	-	-	35	0.28	3.2	-	-
WNMG 080408E-RM-T9415	0.8	265	0.40	4.0	-	-	-	250	0.40	4.0	-	-	-	-	-	-	-	-
WNMG 080412E-RM-T5305	1.2	280	0.45	4.0	-	-	-	265	0.45	4.0	-	-	-	-	-	-	-	-
WNMG 080412E-RM-T5315	1.2	250	0.45	4.0	-	-	-	235	0.45	4.0	-	-	-	-	-	-	-	-
WNMG 080412E-RM-T9325	1.2	200	0.45	4.0	120	0.41	4.0	190	0.45	4.0	-	-	-	45	0.32	3.2	-	-
WNMG 080412E-RM-T9335	1.2	175	0.45	4.0	105	0.41	4.0	-	-	-	-	-	-	35	0.32	3.2	-	-
WNMG 080412E-RM-T9415	1.2	270	0.45	4.0	-	-	-	255	0.45	4.0	-	-	-	-	-	-	-	-
WNMG 080416E-RM-T5305	1.6	280	0.50	4.0	-	-	-	265	0.50	4.0	-	-	-	-	-	-	-	-
WNMG 080416E-RM-T5315	1.6	255	0.50	4.0	-	-	-	240	0.50	4.0	-	-	-	-	-	-	-	-
WNMG 080416E-RM-T8430	1.6	170	0.50	4.0	90	0.45	4.0	135	0.50	4.0	-	-	-	35	0.35	3.2	-	-
WNMG 080416E-RM-T9310	1.6	240	0.50	4.0	-	-	-	225	0.50	4.0	-	-	-	-	-	-	-	-
WNMG 080416E-RM-T9325	1.6	205	0.50	4.0	120	0.45	4.0	190	0.50	4.0	-	-	-	45	0.35	3.2	-	-
WNMG 080416E-RM-T9335	1.6	175	0.50	4.0	105	0.45	4.0	-	-	-	-	-	-	35	0.35	3.2	-	-
WNMG 080416E-RM-T9415	1.6	275	0.50	4.0	-	-	-	260	0.50	4.0	-	-	-	-	-	-	-	-

R

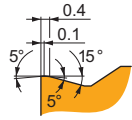

R chip breaker is robust and designed for roughing of Steels and Cast irons. It features slightly positive rake angle and negative/stable, extra-wide double T-land. It's also conditionally suitable for Hard materials.



CNMG

	IC (mm)	D1 (mm)	L (mm)	S (mm)
1204	12.700	5.16	12.90	4.76
1606	15.880	6.35	16.10	6.35
1906	19.050	7.94	19.30	6.35

DNMG

	IC (mm)	D1 (mm)	L (mm)	S (mm)
1504	12.700	5.16	15.50	4.76
1506	12.700	5.16	15.50	6.35

SNMG

	IC (mm)	D1 (mm)	L (mm)	S (mm)
1204	12.700	5.16	12.70	4.76
1506	15.875	6.35	15.88	6.35
1906	19.050	7.94	19.05	6.35

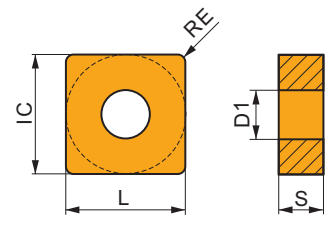
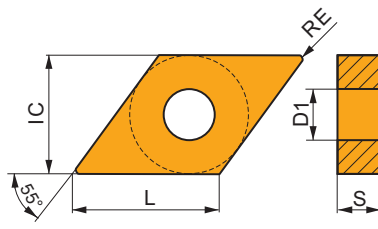
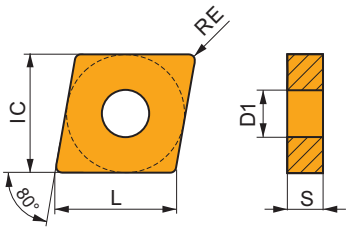

TNMG

	IC (mm)	D1 (mm)	L (mm)	S (mm)
1604	9.525	3.81	16.50	4.76
2204	12.700	5.16	22.00	4.76

WNMG

	IC (mm)	D1 (mm)	L (mm)	S (mm)
0804	12.700	5.16	8.70	4.76

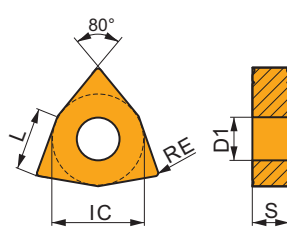
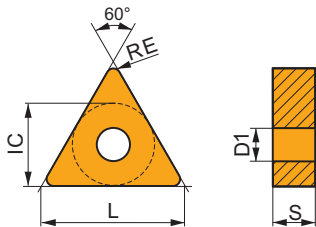

Suitability and starting values for cutting speed (vc), feed (f) and depth of cut (ap). Refer to our Machining Calculator app for further calculations.

Product	RE (mm)	P			M			K			N			S			H		
		vc (m/min)	f (mm/rev)	ap (mm)	vc (m/min)	f (mm/rev)	ap (mm)	vc (m/min)	f (mm/rev)	ap (mm)	vc (m/min)	f (mm/rev)	ap (mm)	vc (m/min)	f (mm/rev)	ap (mm)	vc (m/min)	f (mm/rev)	ap (mm)

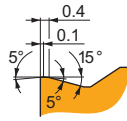

R chip breaker is robust and designed for roughing of Steels and Cast irons. It features slightly positive rake angle and negative/stable, extra-wide double T-land. It's also conditionally suitable for Hard materials.

CNMG 120408E-R:6640	0.8	140	0.40	4.0	-	-	-	130	0.40	4.0	-	-	-	-	-	-	-	-	-
CNMG 120408E-R:T5305	0.8	240	0.40	4.0	-	-	-	225	0.40	4.0	-	-	-	-	-	-	45	0.20	0.7
CNMG 120408E-R:T9325	0.8	215	0.40	4.0	-	-	-	200	0.40	4.0	-	-	-	-	-	-	40	0.20	0.7
CNMG 120408E-R:T9325	0.8	175	0.40	4.0	-	-	-	165	0.40	4.0	-	-	-	-	-	-	-	-	-
CNMG 120408E-R:T9335	0.8	150	0.40	4.0	-	-	-	-	-	-	-	-	-	-	-	-	-	-	-
CNMG 120408E-R:T9415	0.8	230	0.40	4.0	-	-	-	215	0.40	4.0	-	-	-	-	-	-	45	0.20	0.7
CNMG 120412E-R:T9325	1.2	175	0.45	4.0	-	-	-	165	0.45	4.0	-	-	-	-	-	-	-	-	-
CNMG 120412E-R:T9335	1.2	155	0.45	4.0	-	-	-	-	-	-	-	-	-	-	-	-	-	-	-
CNMG 120412E-R:T9415	1.2	235	0.45	4.0	-	-	-	220	0.45	4.0	-	-	-	-	-	-	45	0.23	1.0
CNMG 120416E-R:T5315	1.6	225	0.50	4.0	-	-	-	210	0.50	4.0	-	-	-	-	-	-	45	0.25	1.3
CNMG 120416E-R:T9335	1.6	150	0.50	4.0	-	-	-	-	-	-	-	-	-	-	-	-	-	-	-
CNMG 160608E-R:T5315	0.8	210	0.40	5.5	-	-	-	195	0.40	5.5	-	-	-	-	-	-	40	0.20	0.7
CNMG 160612E-R:T5315	1.2	215	0.45	5.5	-	-	-	200	0.45	5.5	-	-	-	-	-	-	40	0.23	1.0
CNMG 160612E-R:T7335	1.2	145	0.45	5.5	-	-	-	-	-	-	-	-	-	-	-	-	-	-	-
CNMG 160612E-R:T9315	1.2	190	0.45	5.5	-	-	-	180	0.45	5.5	-	-	-	-	-	-	35	0.23	1.0
CNMG 160612E-R:T9325	1.2	170	0.45	5.5	-	-	-	160	0.45	5.5	-	-	-	-	-	-	-	-	-
CNMG 160612E-R:T9415	1.2	230	0.45	5.5	-	-	-	215	0.45	5.5	-	-	-	-	-	-	45	0.23	1.0
CNMG 190612E-R:6630	1.2	150	0.45	7.0	-	-	-	140	0.45	7.0	-	-	-	-	-	-	-	-	-
CNMG 190612E-R:6640	1.2	135	0.45	7.0	-	-	-	125	0.45	7.0	-	-	-	-	-	-	-	-	-
CNMG 190612E-R:T5315	1.2	210	0.45	7.0	-	-	-	195	0.45	7.0	-	-	-	-	-	-	40	0.23	1.0
CNMG 190612E-R:T9325	1.2	165	0.45	7.0	-	-	-	155	0.45	7.0	-	-	-	-	-	-	-	-	-
CNMG 190612E-R:T9335	1.2	145	0.45	7.0	-	-	-	-	-	-	-	-	-	-	-	-	-	-	-
CNMG 190612E-R:T9415	1.2	225	0.45	7.0	-	-	-	210	0.45	7.0	-	-	-	-	-	-	45	0.23	1.0
CNMG 190616E-R:6630	1.6	150	0.50	7.0	-	-	-	140	0.50	7.0	-	-	-	-	-	-	-	-	-
CNMG 190616E-R:6640	1.6	130	0.50	7.0	-	-	-	120	0.50	7.0	-	-	-	-	-	-	-	-	-
CNMG 190616E-R:T5315	1.6	210	0.50	7.0	-	-	-	195	0.50	7.0	-	-	-	-	-	-	40	0.25	1.3
CNMG 190616E-R:T9315	1.6	180	0.50	7.0	-	-	-	170	0.50	7.0	-	-	-	-	-	-	35	0.25	1.3
CNMG 190616E-R:T9325	1.6	165	0.50	7.0	-	-	-	155	0.50	7.0	-	-	-	-	-	-	-	-	-
CNMG 190616E-R:T9335	1.6	145	0.50	7.0	-	-	-	-	-	-	-	-	-	-	-	-	-	-	-
CNMG 190616E-R:T9415	1.6	225	0.50	7.0	-	-	-	210	0.50	7.0	-	-	-	-	-	-	45	0.25	1.3

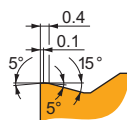

R chip breaker is robust and designed for roughing of Steels and Cast irons. It features slightly positive rake angle and negative/stable, extra-wide double T-land. It's also conditionally suitable for Hard materials.

DNMG 150408E-R:T5315	0.8	175	0.40	3.0	-	-	-	165	0.40	3.0	-	-	-	-	-	-	35	0.20	0.7
DNMG 150608E-R:T5305	0.8	200	0.40	3.0	-	-	-	190	0.40	3.0	-	-	-	-	-	-	40	0.20	0.7
DNMG 150608E-R:T5315	0.8	175	0.40	3.0	-	-	-	165	0.40	3.0	-	-	-	-	-	-	35	0.20	0.7
DNMG 150608E-R:T9325	0.8	140	0.40	3.0	-	-	-	130	0.40	3.0	-	-	-	-	-	-	-	-	-
DNMG 150608E-R:T9415	0.8	190	0.40	3.0	-	-	-	180	0.40	3.0	-	-	-	-	-	-	35	0.20	0.7
DNMG 150612E-R:T5315	1.2	185	0.40	3.0	-	-	-	175	0.40	3.0	-	-	-	-	-	-	35	0.20	0.9
DNMG 150612E-R:T9325	1.2	150	0.40	3.0	-	-	-	140	0.40	3.0	-	-	-	-	-	-	-	-	-
DNMG 150612E-R:T9415	1.2	200	0.40	3.0	-	-	-	190	0.40	3.0	-	-	-	-	-	-	40	0.20	0.9
DNMG 150616E-R:T9325	1.6	155	0.40	3.0	-	-	-	145	0.40	3.0	-	-	-	-	-	-	-	-	-

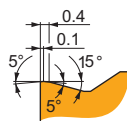
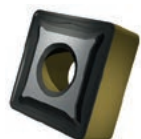

R chip breaker is robust and designed for roughing of Steels and Cast irons. It features slightly positive rake angle and negative/stable, extra-wide double T-land. It's also conditionally suitable for Hard materials.

SNMG 120408E-R:6640	0.8	145	0.40	3.8	-	-	-	135	0.40	3.8	-	-	-	-	-	-	-	-	-
SNMG 120408E-R:T5305	0.8	250	0.40	3.8	-	-	-	235	0.40	3.8	-	-	-	-	-	-	50	0.20	0.7
SNMG 120408E-R:T9325	0.8	180	0.40	3.8	-	-	-	170	0.40	3.8	-	-	-	-	-	-	-	-	-
SNMG 120408E-R:T9335	0.8	155	0.40	3.8	-	-	-	-	-	-	-	-	-	-	-	-	-	-	-
SNMG 120412E-R:T9325	1.2	180	0.45	3.8	-	-	-	170	0.45	3.8	-	-	-	-	-	-	-	-	-
SNMG 120412E-R:T9335	1.2	160	0.45	3.8	-	-	-	-	-	-	-	-	-	-	-	-	-	-	-
SNMG 120416E-R:T9325	1.6	185	0.50	3.8	-	-	-	175	0.50	3.8	-	-	-	-	-	-	-	-	-
SNMG 120416E-R:T9415	1.6	250	0.50	3.8	-	-	-	235	0.50	3.8	-	-	-	-	-	-	50	0.25	1.3

Suitability and starting values for cutting speed (vc), feed (f) and depth of cut (ap). Refer to our Machining Calculator app for further calculations.

Product	RE (mm)	P			M			K			N			S			H		
		vc (m/min)	f (mm/rev)	ap (mm)	vc (m/min)	f (mm/rev)	ap (mm)	vc (m/min)	f (mm/rev)	ap (mm)	vc (m/min)	f (mm/rev)	ap (mm)	vc (m/min)	f (mm/rev)	ap (mm)	vc (m/min)	f (mm/rev)	ap (mm)

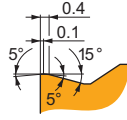

R chip breaker is robust and designed for roughing of Steels and Cast irons. It features slightly positive rake angle and negative/stable, extra-wide double T-land. It's also conditionally suitable for Hard materials.

SNMG 150612E-R:T5315	1.2	230	0.45	4.5	-	-	-	215	0.45	4.5	-	-	-	-	-	-	45	0.23	1.0
SNMG 150612E-R:T9325	1.2	180	0.45	4.5	-	-	-	170	0.45	4.5	-	-	-	-	-	-	-	-	-
SNMG 150612E-R:T9415	1.2	245	0.45	4.5	-	-	-	230	0.45	4.5	-	-	-	-	-	-	45	0.23	1.0
SNMG 150616E-R:T5315	1.6	230	0.50	4.5	-	-	-	215	0.50	4.5	-	-	-	-	-	-	45	0.25	1.3
SNMG 150616E-R:T9325	1.6	180	0.50	4.5	-	-	-	170	0.50	4.5	-	-	-	-	-	-	-	-	-
SNMG 190612E-R:6630	1.2	160	0.45	6.0	-	-	-	150	0.45	6.0	-	-	-	-	-	-	-	-	-
SNMG 190612E-R:6640	1.2	140	0.45	6.0	-	-	-	130	0.45	6.0	-	-	-	-	-	-	-	-	-
SNMG 190612E-R:T9325	1.2	175	0.45	6.0	-	-	-	165	0.45	6.0	-	-	-	-	-	-	-	-	-
SNMG 190616E-R:6630	1.6	165	0.50	6.0	-	-	-	155	0.50	6.0	-	-	-	-	-	-	-	-	-
SNMG 190616E-R:T9325	1.6	175	0.50	6.0	-	-	-	165	0.50	6.0	-	-	-	-	-	-	-	-	-
SNMG 190616E-R:T9335	1.6	150	0.50	6.0	-	-	-	-	-	-	-	-	-	-	-	-	-	-	-
SNMG 190616E-R:T9415	1.6	240	0.50	6.0	-	-	-	225	0.50	6.0	-	-	-	-	-	-	45	0.25	1.3

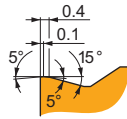
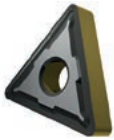

R chip breaker is robust and designed for roughing of Steels and Cast irons. It features slightly positive rake angle and negative/stable, extra-wide double T-land. It's also conditionally suitable for Hard materials.

TNMG 160408E-R:T5305	0.8	210	0.40	3.0	-	-	-	195	0.40	3.0	-	-	-	-	-	-	40	0.20	0.7
TNMG 160408E-R:T5315	0.8	185	0.40	3.0	-	-	-	175	0.40	3.0	-	-	-	-	-	-	35	0.20	0.7
TNMG 160408E-R:T9325	0.8	150	0.40	3.0	-	-	-	140	0.40	3.0	-	-	-	-	-	-	-	-	-
TNMG 160408E-R:T9335	0.8	130	0.40	3.0	-	-	-	-	-	-	-	-	-	-	-	-	-	-	-
TNMG 160408E-R:T9415	0.8	205	0.40	3.0	-	-	-	190	0.40	3.0	-	-	-	-	-	-	40	0.20	0.7
TNMG 160412E-R:T5315	1.2	195	0.40	3.0	-	-	-	185	0.40	3.0	-	-	-	-	-	-	35	0.20	0.9
TNMG 160412E-R:T9325	1.2	160	0.40	3.0	-	-	-	150	0.40	3.0	-	-	-	-	-	-	-	-	-
TNMG 160412E-R:T9335	1.2	140	0.40	3.0	-	-	-	-	-	-	-	-	-	-	-	-	-	-	-
TNMG 160412E-R:T9415	1.2	215	0.40	3.0	-	-	-	200	0.40	3.0	-	-	-	-	-	-	40	0.20	0.9
TNMG 220408E-R:T9325	0.8	145	0.40	4.0	-	-	-	135	0.40	4.0	-	-	-	-	-	-	-	-	-
TNMG 220408E-R:T9335	0.8	125	0.40	4.0	-	-	-	-	-	-	-	-	-	-	-	-	-	-	-
TNMG 220408E-R:T9415	0.8	195	0.40	4.0	-	-	-	185	0.40	4.0	-	-	-	-	-	-	35	0.20	0.7
TNMG 220412E-R:T9325	1.2	155	0.40	4.0	-	-	-	145	0.40	4.0	-	-	-	-	-	-	-	-	-
TNMG 220412E-R:T9415	1.2	205	0.40	4.0	-	-	-	190	0.40	4.0	-	-	-	-	-	-	40	0.20	0.9
TNMG 220416E-R:T9325	1.6	165	0.40	4.0	-	-	-	155	0.40	4.0	-	-	-	-	-	-	-	-	-

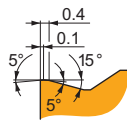
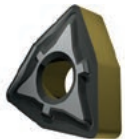

R chip breaker is robust and designed for roughing of Steels and Cast irons. It features slightly positive rake angle and negative/stable, extra-wide double T-land. It's also conditionally suitable for Hard materials.

WNMG 080408E-R:T5305	0.8	245	0.40	3.5	-	-	-	230	0.40	3.5	-	-	-	-	-	-	45	0.20	0.7
WNMG 080408E-R:T5315	0.8	220	0.40	3.5	-	-	-	205	0.40	3.5	-	-	-	-	-	-	40	0.20	0.7
WNMG 080408E-R:T9310	0.8	210	0.40	3.5	-	-	-	195	0.40	3.5	-	-	-	-	-	-	40	0.20	0.7
WNMG 080408E-R:T9325	0.8	175	0.40	3.5	-	-	-	165	0.40	3.5	-	-	-	-	-	-	-	-	-
WNMG 080408E-R:T9335	0.8	155	0.40	3.5	-	-	-	-	-	-	-	-	-	-	-	-	-	-	-
WNMG 080408E-R:T9415	0.8	235	0.40	3.5	-	-	-	220	0.40	3.5	-	-	-	-	-	-	45	0.20	0.7
WNMG 080412E-R:T5305	1.2	250	0.45	3.5	-	-	-	235	0.45	3.5	-	-	-	-	-	-	50	0.23	1.0
WNMG 080412E-R:T5315	1.2	225	0.45	3.5	-	-	-	210	0.45	3.5	-	-	-	-	-	-	45	0.23	1.0
WNMG 080412E-R:T9310	1.2	215	0.45	3.5	-	-	-	200	0.45	3.5	-	-	-	-	-	-	40	0.23	1.0
WNMG 080412E-R:T9325	1.2	180	0.45	3.5	-	-	-	170	0.45	3.5	-	-	-	-	-	-	-	-	-
WNMG 080412E-R:T9335	1.2	155	0.45	3.5	-	-	-	-	-	-	-	-	-	-	-	-	-	-	-
WNMG 080412E-R:T9415	1.2	240	0.45	3.5	-	-	-	225	0.45	3.5	-	-	-	-	-	-	45	0.23	1.0

NRM

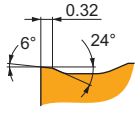

NRM chip breaker is versatile and the first choice for roughing of Stainless steels. It features positive rake angle and stable, wide T-land. It's also suitable for Steels and Super-alloys.



CNMG / CNMM

	IC (mm)	D1 (mm)	L (mm)	S (mm)
1204	12.700	5.16	12.90	4.76
1606	15.875	6.35	16.10	6.35
1906	19.050	7.94	19.30	6.35
2509	25.400	9.12	25.80	9.53

DNMG

	IC (mm)	D1 (mm)	L (mm)	S (mm)
1506	12.700	5.16	15.50	6.35

SNMG / SNMM

	IC (mm)	D1 (mm)	L (mm)	S (mm)
1204	12.700	5.16	12.70	4.76
1506	15.875	6.35	15.88	6.35
2507	25.400	9.12	25.40	7.94
2509	25.400	9.12	25.40	9.53

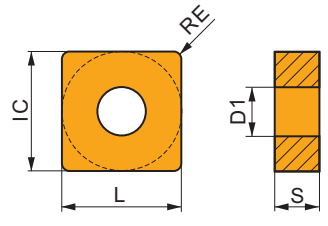
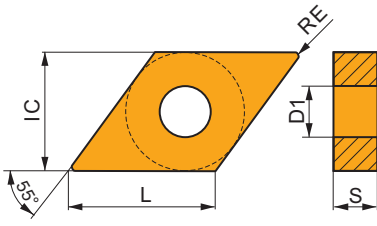
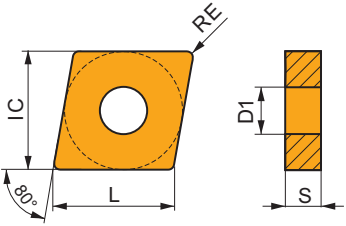

WNMG

	IC (mm)	D1 (mm)	L (mm)	S (mm)
0804	12.700	5.16	8.70	4.76

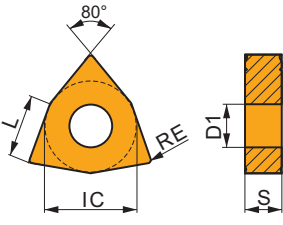

Suitability and starting values for cutting speed (vc), feed (f) and depth of cut (ap). Refer to our Machining Calculator app for further calculations.

Product	RE (mm)	P			M			K			N			S			H		
		vc (m/min)	f (mm/rev)	ap (mm)	vc (m/min)	f (mm/rev)	ap (mm)	vc (m/min)	f (mm/rev)	ap (mm)	vc (m/min)	f (mm/rev)	ap (mm)	vc (m/min)	f (mm/rev)	ap (mm)	vc (m/min)	f (mm/rev)	ap (mm)

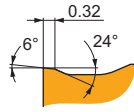
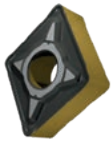

NRM chip breaker is versatile and the first choice for roughing of Stainless steels. It features positive rake angle and stable, wide T-land. It's also suitable for Steels and Super-alloys.

CNMG 120408-NRM:T7325	0.8	✓	160	0.35	4.0	■	120	0.32	4.0	—	—	—	—	—	—	■	50	0.28	3.2	—	—	—
CNMG 120408-NRM:T8430	0.8	■	150	0.35	4.0	■	80	0.32	4.0	—	—	—	—	—	—	■	30	0.25	3.2	—	—	—
CNMG 120408-NRM:T9415	0.8	■	245	0.35	4.0	—	—	—	—	—	—	—	—	—	—	—	—	—	—	—	—	—
CNMG 120412-NRM:T7325	1.2	✓	165	0.40	4.0	■	125	0.36	4.0	—	—	—	—	—	—	■	50	0.28	3.2	—	—	—
CNMG 120412-NRM:T8430	1.2	■	150	0.40	4.0	■	80	0.36	4.0	—	—	—	—	—	—	■	30	0.28	3.2	—	—	—
CNMG 120412-NRM:T9415	1.2	■	245	0.40	4.0	—	—	—	—	—	—	—	—	—	—	—	—	—	—	—	—	—
CNMG 160608-NRM:T7325	0.8	✓	155	0.35	6.0	■	120	0.32	6.0	—	—	—	—	—	—	■	50	0.28	4.8	—	—	—
CNMG 160608-NRM:T9415	0.8	■	235	0.35	6.0	—	—	—	—	—	—	—	—	—	—	—	—	—	—	—	—	—
CNMG 160612-NRM:T7325	1.2	✓	155	0.40	6.0	■	120	0.36	6.0	—	—	—	—	—	—	■	50	0.32	4.8	—	—	—
CNMG 160612-NRM:T7335	1.2	✓	150	0.40	6.0	■	115	0.36	6.0	—	—	—	—	—	—	■	45	0.32	4.8	—	—	—
CNMG 160612-NRM:T9415	1.2	■	235	0.40	6.0	—	—	—	—	—	—	—	—	—	—	—	—	—	—	—	—	—
CNMG 160616-NRM:T7325	1.6	✓	155	0.45	6.0	■	120	0.41	6.0	—	—	—	—	—	—	■	50	0.36	4.8	—	—	—
CNMG 160616-NRM:T7335	1.6	✓	150	0.45	6.0	■	115	0.41	6.0	—	—	—	—	—	—	■	45	0.36	4.8	—	—	—
CNMG 160616-NRM:T8430	1.6	■	145	0.45	6.0	■	80	0.41	6.0	—	—	—	—	—	—	■	30	0.32	4.8	—	—	—
CNMG 160616-NRM:T9415	1.6	■	240	0.45	6.0	—	—	—	—	—	—	—	—	—	—	—	—	—	—	—	—	—
CNMG 190612-NRM:T7325	1.2	✓	155	0.40	8.0	■	120	0.36	8.0	—	—	—	—	—	—	■	50	0.32	6.4	—	—	—
CNMG 190612-NRM:T8430	1.2	■	140	0.40	8.0	■	75	0.36	8.0	—	—	—	—	—	—	■	30	0.28	6.4	—	—	—
CNMG 190612-NRM:T9415	1.2	■	230	0.40	8.0	—	—	—	—	—	—	—	—	—	—	—	—	—	—	—	—	—
CNMG 190616-NRM:T7325	1.6	✓	150	0.45	8.0	■	115	0.41	8.0	—	—	—	—	—	—	■	45	0.36	6.4	—	—	—
CNMG 190616-NRM:T7335	1.6	✓	145	0.45	8.0	■	110	0.41	8.0	—	—	—	—	—	—	■	45	0.36	6.4	—	—	—
CNMG 190616-NRM:T8430	1.6	■	140	0.45	8.0	■	75	0.41	8.0	—	—	—	—	—	—	■	30	0.32	6.4	—	—	—
CNMG 190616-NRM:T9415	1.6	■	230	0.45	8.0	—	—	—	—	—	—	—	—	—	—	—	—	—	—	—	—	—
CNMG 250924-NRM:T7325	2.4	✓	95	0.70	10.0	■	70	0.63	10.0	—	—	—	—	—	—	■	30	0.49	8.0	—	—	—
CNMG 250924-NRM:T7335	2.4	✓	90	0.70	10.0	■	70	0.63	10.0	—	—	—	—	—	—	■	25	0.49	8.0	—	—	—

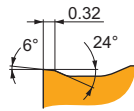

NRM chip breaker is versatile and the first choice for roughing of Stainless steels. It features positive rake angle and stable, wide T-land. It's also suitable for Steels and Super-alloys.

CNMM 250924-NRM:T7325	2.4	✓	95	0.70	10.0	■	70	0.63	10.0	—	—	—	—	—	—	■	30	0.49	8.0	—	—	—
CNMM 250924-NRM:T7335	2.4	✓	90	0.70	10.0	■	70	0.63	10.0	—	—	—	—	—	—	■	25	0.49	8.0	—	—	—

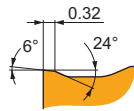
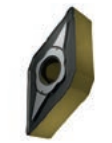

NRM chip breaker is versatile and the first choice for roughing of Stainless steels. It features positive rake angle and stable, wide T-land. It's also suitable for Steels and Super-alloys.

DNMG 150608-NRM:T7335	0.8	✓	130	0.30	3.0	■	100	0.27	3.0	—	—	—	—	—	—	■	40	0.24	2.4	—	—	—
DNMG 150608-NRM:T9415	0.8	■	210	0.30	3.0	—	—	—	—	—	—	—	—	—	—	—	—	—	—	—	—	—

Suitability and starting values for cutting speed (vc), feed (f) and depth of cut (ap). Refer to our Machining Calculator app for further calculations.

Product	RE (mm)	P			M			K			N			S			H		
		vc (m/min)	f (mm/rev)	ap (mm)	vc (m/min)	f (mm/rev)	ap (mm)	vc (m/min)	f (mm/rev)	ap (mm)	vc (m/min)	f (mm/rev)	ap (mm)	vc (m/min)	f (mm/rev)	ap (mm)	vc (m/min)	f (mm/rev)	ap (mm)

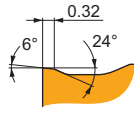
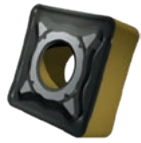

NRM chip breaker is versatile and the first choice for roughing of Stainless steels. It features positive rake angle and stable, wide T-land. It's also suitable for Steels and Super-alloys.

SNMG 120408-NRM:T7325	0.8	175	0.35	2.6	135	0.32	2.6	-	-	-	-	-	55	0.28	2.1	-	-	-
SNMG 120412-NRM:T8430	1.2	165	0.40	3.0	90	0.36	3.0	-	-	-	-	-	35	0.28	2.4	-	-	-
SNMG 120412-NRM:T9415	1.2	265	0.40	3.0	-	-	-	-	-	-	-	-	-	-	-	-	-	-
SNMG 150612-NRM:T7325	1.2	170	0.40	4.0	130	0.36	4.0	-	-	-	-	-	55	0.32	3.2	-	-	-
SNMG 150616-NRM:T7325	1.6	170	0.45	5.0	130	0.41	5.0	-	-	-	-	-	55	0.36	4.0	-	-	-
SNMG 150616-NRM:T8430	1.6	150	0.45	5.0	80	0.41	5.0	-	-	-	-	-	30	0.32	4.0	-	-	-
SNMG 150616-NRM:T9415	1.6	250	0.45	5.0	-	-	-	-	-	-	-	-	-	-	-	-	-	-
SNMG 250924-NRM:T7325	2.4	105	0.70	9.0	80	0.63	9.0	-	-	-	-	-	30	0.49	7.2	-	-	-
SNMG 250924-NRM:T9415	2.4	125	0.70	9.0	-	-	-	115	0.70	9.0	-	-	-	-	-	-	-	-

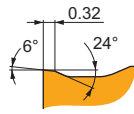
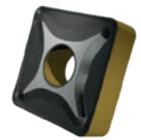

NRM chip breaker is versatile and the first choice for roughing of Stainless steels. It features positive rake angle and stable, wide T-land. It's also suitable for Steels and Super-alloys.

SNMM 250716-NRM:T9415	1.6	140	0.45	9.0	-	-	-	130	0.45	9.0	-	-	-	-	-	-	-	-
SNMM 250724-NRM:T9415	2.4	130	0.65	9.0	-	-	-	120	0.65	9.0	-	-	-	-	-	-	-	-
SNMM 250924-NRM:T7325	2.4	105	0.70	9.0	80	0.63	9.0	-	-	-	-	-	30	0.49	7.2	-	-	-
SNMM 250924-NRM:T7335	2.4	95	0.70	9.0	70	0.63	9.0	-	-	-	-	-	30	0.49	7.2	-	-	-
SNMM 250924-NRM:T8430	2.4	130	0.70	9.0	70	0.63	9.0	105	0.70	9.0	-	-	25	0.49	7.2	-	-	-

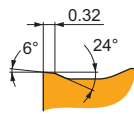
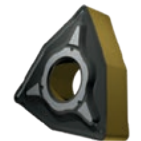

NRM chip breaker is versatile and the first choice for roughing of Stainless steels. It features positive rake angle and stable, wide T-land. It's also suitable for Steels and Super-alloys.

WNMG 080408-NRM:T7325	0.8	170	0.35	2.7	130	0.32	2.7	-	-	-	-	-	55	0.28	2.2	-	-	-
WNMG 080408-NRM:T7335	0.8	160	0.35	2.7	120	0.32	2.7	-	-	-	-	-	50	0.28	2.2	-	-	-
WNMG 080408-NRM:T9415	0.8	255	0.35	2.7	-	-	-	-	-	-	-	-	-	-	-	-	-	-
WNMG 080412-NRM:T7325	1.2	170	0.40	2.7	130	0.36	2.7	-	-	-	-	-	55	0.28	2.2	-	-	-
WNMG 080412-NRM:T8430	1.2	155	0.40	2.7	85	0.36	2.7	-	-	-	-	-	30	0.28	2.2	-	-	-
WNMG 080412-NRM:T9315	1.2	215	0.40	2.7	-	-	-	-	-	-	-	-	-	-	-	-	-	-
WNMG 080412-NRM:T9415	1.2	255	0.40	2.7	-	-	-	-	-	-	-	-	-	-	-	-	-	-

KR

KR chip breaker is robust and the first choice for roughing of Cast irons. It features slightly positive rake angle and , wide T-land. It's also suitable for Steels, and conditionally for Hard materials.

PRAMET

CNMG

	IC	D1	L	S
	(mm)	(mm)	(mm)	(mm)
1204	12.700	5.16	12.90	4.76

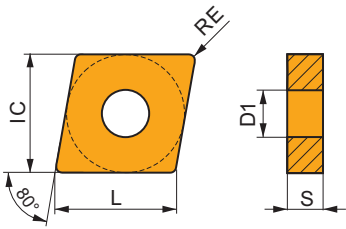

DNMG

	IC	D1	L	S
	(mm)	(mm)	(mm)	(mm)
1506	12.700	5.16	15.50	6.35

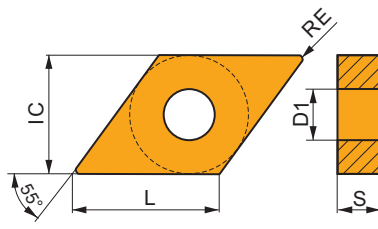

SNMG

	IC	D1	L	S
	(mm)	(mm)	(mm)	(mm)
1204	12.700	5.16	12.70	4.76

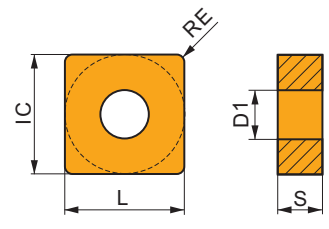

TNMG

	IC	D1	L	S
	(mm)	(mm)	(mm)	(mm)
1604	9.525	3.81	16.50	4.76

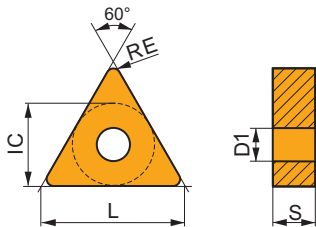

WNMG

	IC	D1	L	S
	(mm)	(mm)	(mm)	(mm)
0804	12.700	5.16	8.70	4.76

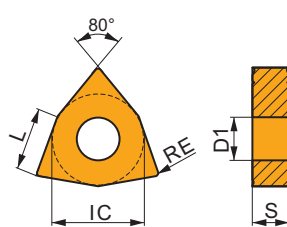

Suitability and starting values for cutting speed (vc), feed (f) and depth of cut (ap). Refer to our Machining Calculator app for further calculations.

Product	RE (mm)	P			M			K			N			S			H		
		vc (m/min)	f (mm/rev)	ap (mm)	vc (m/min)	f (mm/rev)	ap (mm)	vc (m/min)	f (mm/rev)	ap (mm)	vc (m/min)	f (mm/rev)	ap (mm)	vc (m/min)	f (mm/rev)	ap (mm)	vc (m/min)	f (mm/rev)	ap (mm)

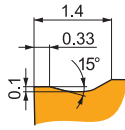

KR chip breaker is robust and the first choice for roughing of Cast irons. It features slightly positive rake angle and , wide T-land. It's also suitable for Steels, and conditionally for Hard materials.

CNMG 120408E-KR-T5305	● 0.8	✔ 255	0.35	4.0	–	–	–	✔ 240	0.35	4.0	–	–	–	–	–	–	–	–	✔ 50	0.18	0.7
CNMG 120408E-KR-T5315	● 0.8	✔ 225	0.35	4.0	–	–	–	✔ 210	0.35	4.0	–	–	–	–	–	–	–	–	✔ 45	0.18	0.7
CNMG 120412E-KR-T5305	● 1.2	✔ 255	0.40	4.0	–	–	–	✔ 240	0.40	4.0	–	–	–	–	–	–	–	–	✔ 50	0.20	1.0
CNMG 120412E-KR-T5315	● 1.2	✔ 230	0.40	4.0	–	–	–	✔ 215	0.40	4.0	–	–	–	–	–	–	–	–	✔ 45	0.20	1.0
CNMG 120416E-KR-T5315	● 1.6	✔ 230	0.45	4.0	–	–	–	✔ 215	0.45	4.0	–	–	–	–	–	–	–	–	✔ 45	0.32	0.8
CNMG 160612E-KR-T5315	● 1.2	✔ 230	0.45	4.5	–	–	–	✔ 215	0.45	4.5	–	–	–	–	–	–	–	–	✔ 45	0.32	0.8
CNMG 160616E-KR-T5315	● 1.6	✔ 230	0.50	4.5	–	–	–	✔ 215	0.50	4.5	–	–	–	–	–	–	–	–	✔ 45	0.35	0.8
CNMG 190612E-KR-T5315	● 1.2	✔ 220	0.45	7.0	–	–	–	✔ 205	0.45	7.0	–	–	–	–	–	–	–	–	✔ 40	0.32	0.8
CNMG 190616E-KR-T5315	● 1.6	✔ 220	0.50	7.0	–	–	–	✔ 205	0.50	7.0	–	–	–	–	–	–	–	–	✔ 40	0.35	0.8

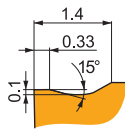

KR chip breaker is robust and the first choice for roughing of Cast irons. It features slightly positive rake angle and , wide T-land. It's also suitable for Steels, and conditionally for Hard materials.

DNMG 150608E-KR-T5315	● 0.8	✔ 195	0.35	3.0	–	–	–	✔ 185	0.35	3.0	–	–	–	–	–	–	–	–	✔ 35	0.25	0.8
DNMG 150612E-KR-T5315	● 1.2	✔ 195	0.40	3.0	–	–	–	✔ 185	0.40	3.0	–	–	–	–	–	–	–	–	✔ 35	0.28	0.8

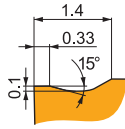

KR chip breaker is robust and the first choice for roughing of Cast irons. It features slightly positive rake angle and , wide T-land. It's also suitable for Steels, and conditionally for Hard materials.

SNMG 120408E-KR-T5305	● 0.8	✔ 265	0.35	3.8	–	–	–	✔ 250	0.35	3.8	–	–	–	–	–	–	–	–	✔ 50	0.18	0.7
SNMG 120408E-KR-T5315	● 0.8	✔ 235	0.35	3.8	–	–	–	✔ 220	0.35	3.8	–	–	–	–	–	–	–	–	✔ 45	0.18	0.7
SNMG 120412E-KR-T5315	● 1.2	✔ 240	0.40	3.8	–	–	–	✔ 225	0.40	3.8	–	–	–	–	–	–	–	–	✔ 45	0.20	1.0
SNMG 120416E-KR-T5315	● 1.6	✔ 260	0.45	3.8	–	–	–	✔ 245	0.45	3.8	–	–	–	–	–	–	–	–	✔ 50	0.32	0.8
SNMG 150612E-KR-T5315	● 1.2	✔ 240	0.45	4.5	–	–	–	✔ 225	0.45	4.5	–	–	–	–	–	–	–	–	✔ 45	0.32	0.8
SNMG 150616E-KR-T5315	● 1.6	✔ 240	0.50	4.5	–	–	–	✔ 225	0.50	4.5	–	–	–	–	–	–	–	–	✔ 45	0.35	0.8
SNMG 190616E-KR-T5315	● 1.6	✔ 230	0.50	7.0	–	–	–	✔ 215	0.50	7.0	–	–	–	–	–	–	–	–	✔ 45	0.35	0.8

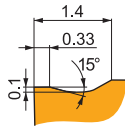

KR chip breaker is robust and the first choice for roughing of Cast irons. It features slightly positive rake angle and , wide T-land. It's also suitable for Steels, and conditionally for Hard materials.

TNMG 160408E-KR-T5305	● 0.8	✔ 220	0.35	3.0	–	–	–	✔ 205	0.35	3.0	–	–	–	–	–	–	–	–	✔ 40	0.18	0.7
TNMG 160408E-KR-T5315	● 0.8	✔ 200	0.35	3.0	–	–	–	✔ 190	0.35	3.0	–	–	–	–	–	–	–	–	✔ 40	0.18	0.7
TNMG 220408E-KR-T5315	● 0.8	✔ 200	0.35	4.0	–	–	–	✔ 190	0.35	4.0	–	–	–	–	–	–	–	–	✔ 40	0.25	0.8
TNMG 220412E-KR-T5315	● 1.2	✔ 205	0.40	4.0	–	–	–	✔ 190	0.40	4.0	–	–	–	–	–	–	–	–	✔ 40	0.28	0.8

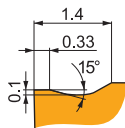

KR chip breaker is robust and the first choice for roughing of Cast irons. It features slightly positive rake angle and , wide T-land. It's also suitable for Steels, and conditionally for Hard materials.

WNMG 080408E-KR-T5305	● 0.8	✔ 255	0.35	3.5	–	–	–	✔ 240	0.35	3.5	–	–	–	–	–	–	–	–	✔ 50	0.18	0.7
WNMG 080408E-KR-T5315	● 0.8	✔ 230	0.35	3.5	–	–	–	✔ 215	0.35	3.5	–	–	–	–	–	–	–	–	✔ 45	0.18	0.7
WNMG 080412E-KR-T5315	● 1.2	✔ 235	0.40	3.5	–	–	–	✔ 220	0.40	3.5	–	–	–	–	–	–	–	–	✔ 45	0.20	1.0

HEAVY ROUGHING – NAVIGATOR

OR			<p>OR chip breaker is robust and the first choice for heavy roughing of Steels. It features positive rake angle and negative/stable, extra-wide double T-land. It's also suitable for Cast irons, and conditionally for Stainless steels and Super-alloys.</p>
NR2			<p>NR2 chip breaker is robust and the first choice for heavy roughing of Stainless steels. It features positive rake angle and negative/negative, extra-wide double T-land. It's also suitable for Steels, and conditionally for Cast irons and Super-alloys.</p>
HR			<p>HR chip breaker is robust and designed for heavy roughing of Steels and Cast irons. It features slightly positive rake angle and negative/negative, extra-wide double T-land. It's also conditionally suitable for Stainless steels.</p>
HR2			<p>HR2 chip breaker is robust and designed for heavy roughing of Steels and Cast irons. It features positive rake angle and stable, extra-wide double T-land. It's also conditionally suitable for Stainless steels.</p>
923			<p>923 chip breaker is robust and designed for heavy roughing of Stainless steels. It features positive rake angle and negative/stable, extra-wide double T-land. It's also conditionally suitable for Steels and Cast irons.</p>

OR

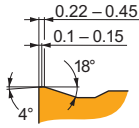

OR chip breaker is robust and the first choice for heavy roughing of Steels. It features positive rake angle and negative/stable, extra-wide double T-land. It's also suitable for Cast irons, and conditionally for Stainless steels and Super-alloys.



CNMM

	IC (mm)	D1 (mm)	L (mm)	S (mm)
1204	12.700	5.16	12.90	4.76
1606	15.875	6.35	16.10	6.35
1906	19.050	7.94	19.30	6.35
2509	25.400	9.12	25.80	9.53

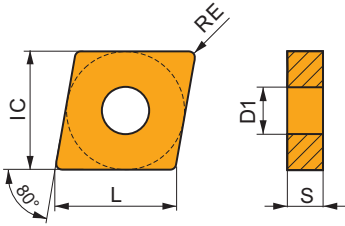

DNMM

	IC (mm)	D1 (mm)	L (mm)	S (mm)
1506	12.700	5.16	15.50	6.35

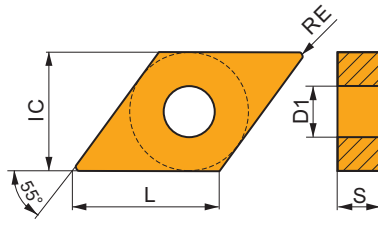

SNMM

	IC (mm)	D1 (mm)	L (mm)	S (mm)
1204	12.700	5.16	12.70	4.76
1506	15.875	6.35	15.88	6.35
1906	19.050	7.94	19.05	6.35
2507	25.400	9.12	25.40	7.94
2509	25.400	9.12	25.40	9.53

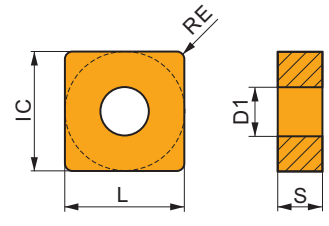

TNMM

	IC (mm)	D1 (mm)	L (mm)	S (mm)
1604	9.525	3.81	16.50	4.76
2204	12.700	5.16	22.00	4.76

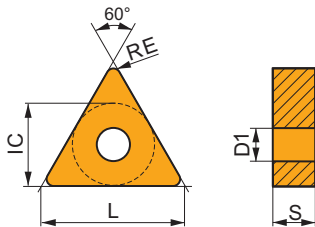

WNMM

	IC (mm)	D1 (mm)	L (mm)	S (mm)
0804	12.700	5.16	8.70	4.76
1306	19.050	7.94	13.00	6.35

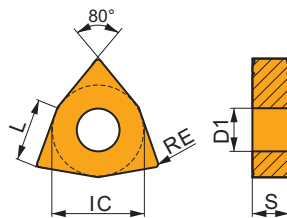

Suitability and starting values for cutting speed (vc), feed (f) and depth of cut (ap). Refer to our Machining Calculator app for further calculations.

Product	RE (mm)	P			M			K			N			S			H		
		vc (m/min)	f (mm/rev)	ap (mm)	vc (m/min)	f (mm/rev)	ap (mm)	vc (m/min)	f (mm/rev)	ap (mm)	vc (m/min)	f (mm/rev)	ap (mm)	vc (m/min)	f (mm/rev)	ap (mm)	vc (m/min)	f (mm/rev)	ap (mm)

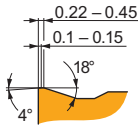
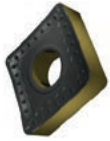

OR chip breaker is robust and the first choice for heavy roughing of Steels. It features positive rake angle and negative/stable, extra-wide double T-land. It's also suitable for Cast irons, and conditionally for Stainless steels and Super-alloys.

CNMM 120408E-OR:T8430	0.8	150	0.40	5.0	80	0.36	5.0	125	0.40	5.0	-	-	-	30	0.28	4.0	-	-	-
CNMM 120408E-OR:T9325	0.8	185	0.40	5.0	110	0.36	5.0	175	0.40	5.0	-	-	-	40	0.28	4.0	-	-	-
CNMM 120408E-OR:T9335	0.8	160	0.40	5.0	95	0.36	5.0	-	-	-	-	-	-	35	0.28	4.0	-	-	-
CNMM 120408E-OR:T9415	0.8	250	0.40	5.0	-	-	-	235	0.40	5.0	-	-	-	-	-	-	-	-	-
CNMM 120412E-OR:T9325	1.2	185	0.45	5.0	110	0.41	5.0	175	0.45	5.0	-	-	-	40	0.36	4.0	-	-	-
CNMM 120412E-OR:T9335	1.2	165	0.45	5.0	95	0.41	5.0	-	-	-	-	-	-	35	0.36	4.0	-	-	-
CNMM 120412E-OR:T9415	1.2	250	0.45	5.0	-	-	-	235	0.45	5.0	-	-	-	-	-	-	-	-	-
CNMM 120416E-OR:T9325	1.6	190	0.50	5.0	110	0.45	5.0	180	0.50	5.0	-	-	-	40	0.40	4.0	-	-	-
CNMM 160608E-OR:T9325	0.8	180	0.40	6.0	105	0.36	6.0	170	0.40	6.0	-	-	-	40	0.32	4.8	-	-	-
CNMM 160608E-OR:T9415	0.8	245	0.40	6.0	-	-	-	230	0.40	6.0	-	-	-	-	-	-	-	-	-
CNMM 160612E-OR:T8430	1.2	150	0.45	6.0	80	0.41	6.0	125	0.45	6.0	-	-	-	30	0.36	4.8	-	-	-
CNMM 160612E-OR:T9325	1.2	185	0.45	6.0	110	0.41	6.0	175	0.45	6.0	-	-	-	40	0.36	4.8	-	-	-
CNMM 160612E-OR:T9415	1.2	250	0.45	6.0	-	-	-	235	0.45	6.0	-	-	-	-	-	-	-	-	-
CNMM 160616E-OR:T9325	1.6	180	0.50	6.0	105	0.45	6.0	170	0.50	6.0	-	-	-	40	0.40	4.8	-	-	-
CNMM 160616E-OR:T9415	1.6	250	0.50	6.0	-	-	-	235	0.50	6.0	-	-	-	-	-	-	-	-	-
CNMM 190612E-OR:T8430	1.2	140	0.45	9.0	75	0.41	9.0	115	0.45	9.0	-	-	-	30	0.36	7.2	-	-	-
CNMM 190612E-OR:T9325	1.2	175	0.45	9.0	105	0.41	9.0	165	0.45	9.0	-	-	-	35	0.36	7.2	-	-	-
CNMM 190612E-OR:T9335	1.2	150	0.45	9.0	90	0.41	9.0	-	-	-	-	-	-	30	0.36	7.2	-	-	-
CNMM 190612E-OR:T9415	1.2	240	0.45	9.0	-	-	-	225	0.45	9.0	-	-	-	-	-	-	-	-	-
CNMM 190616E-OR:6630	1.6	160	0.50	9.0	95	0.45	9.0	150	0.50	9.0	-	-	-	40	0.40	7.2	-	-	-
CNMM 190616E-OR:T8430	1.6	140	0.50	9.0	75	0.45	9.0	115	0.50	9.0	-	-	-	30	0.40	7.2	-	-	-
CNMM 190616E-OR:T9325	1.6	175	0.50	9.0	105	0.45	9.0	165	0.50	9.0	-	-	-	35	0.40	7.2	-	-	-
CNMM 190616E-OR:T9335	1.6	155	0.50	9.0	90	0.45	9.0	-	-	-	-	-	-	30	0.40	7.2	-	-	-
CNMM 190616E-OR:T9415	1.6	240	0.50	9.0	-	-	-	225	0.50	9.0	-	-	-	-	-	-	-	-	-
CNMM 190624E-OR:T9315	2.4	165	0.80	9.0	-	-	-	155	0.80	9.0	-	-	-	-	-	-	-	-	-
CNMM 190624E-OR:T9325	2.4	150	0.80	9.0	90	0.72	9.0	140	0.80	9.0	-	-	-	30	0.56	7.2	-	-	-
CNMM 190624E-OR:T9415	2.4	215	0.80	9.0	-	-	-	200	0.80	9.0	-	-	-	-	-	-	-	-	-
CNMM 250924E-OR:6630	2.4	80	1.00	12.0	45	0.90	12.0	75	1.00	12.0	-	-	-	20	0.70	9.6	-	-	-
CNMM 250924E-OR:T8430	2.4	75	1.00	12.0	40	0.90	12.0	60	1.00	12.0	-	-	-	15	0.70	9.6	-	-	-
CNMM 250924E-OR:T9325	2.4	95	1.00	12.0	55	0.90	12.0	90	1.00	12.0	-	-	-	20	0.70	9.6	-	-	-
CNMM 250924E-OR:T9335	2.4	75	1.00	12.0	45	0.90	12.0	-	-	-	-	-	-	15	0.70	9.6	-	-	-
CNMM 250924E-OR:T9415	2.4	110	1.00	12.0	-	-	-	100	1.00	12.0	-	-	-	-	-	-	-	-	-

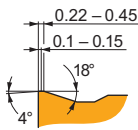

OR chip breaker is robust and the first choice for heavy roughing of Steels. It features positive rake angle and negative/stable, extra-wide double T-land. It's also suitable for Cast irons, and conditionally for Stainless steels and Super-alloys.

DNMM 150608E-OR:T9325	0.8	155	0.40	3.0	90	0.36	3.0	145	0.40	3.0	-	-	-	30	0.28	2.4	-	-	-
DNMM 150612E-OR:T9325	1.2	165	0.40	3.0	95	0.36	3.0	155	0.40	3.0	-	-	-	35	0.32	2.4	-	-	-
DNMM 150612E-OR:T9335	1.2	145	0.40	3.0	85	0.36	3.0	-	-	-	-	-	-	30	0.32	2.4	-	-	-
DNMM 150612E-OR:T9415	1.2	220	0.40	3.0	-	-	-	205	0.40	3.0	-	-	-	-	-	-	-	-	-
DNMM 150616E-OR:T9325	1.6	165	0.45	3.0	95	0.41	3.0	155	0.45	3.0	-	-	-	35	0.41	2.4	-	-	-

Suitability and starting values for cutting speed (vc), feed (f) and depth of cut (ap). Refer to our Machining Calculator app for further calculations.

Product	RE (mm)	P			M			K			N			S			H		
		vc (m/min)	f (mm/rev)	ap (mm)	vc (m/min)	f (mm/rev)	ap (mm)	vc (m/min)	f (mm/rev)	ap (mm)	vc (m/min)	f (mm/rev)	ap (mm)	vc (m/min)	f (mm/rev)	ap (mm)	vc (m/min)	f (mm/rev)	ap (mm)

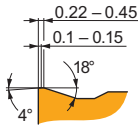

OR chip breaker is robust and the first choice for heavy roughing of Steels. It features positive rake angle and negative/stable, extra-wide double T-land. It's also suitable for Cast irons, and conditionally for Stainless steels and Super-alloys.

SNMM 120408E-OR:T9325	0.8	195	0.40	4.7	115	0.36	4.7	185	0.40	4.7	-	-	-	40	0.32	3.8	-	-	-
SNMM 120408E-OR:T9335	0.8	175	0.40	4.7	105	0.36	4.7	-	-	-	-	-	-	35	0.32	3.8	-	-	-
SNMM 120408E-OR:T9415	0.8	265	0.40	4.7	-	-	-	250	0.40	4.7	-	-	-	-	-	-	-	-	-
SNMM 120412E-OR:T9325	1.2	200	0.45	4.7	120	0.41	4.7	190	0.45	4.7	-	-	-	45	0.36	3.8	-	-	-
SNMM 120412E-OR:T9415	1.2	270	0.45	4.7	-	-	-	255	0.45	4.7	-	-	-	-	-	-	-	-	-
SNMM 120416E-OR:T9325	1.6	200	0.50	4.7	120	0.45	4.7	190	0.50	4.7	-	-	-	45	0.40	3.8	-	-	-
SNMM 150608E-OR:T9325	0.8	190	0.40	6.0	110	0.36	6.0	180	0.40	6.0	-	-	-	40	0.36	4.8	-	-	-
SNMM 150612E-OR:T9325	1.2	195	0.45	6.0	115	0.41	6.0	185	0.45	6.0	-	-	-	40	0.36	4.8	-	-	-
SNMM 150616E-OR:T9325	1.6	190	0.50	6.0	110	0.45	6.0	180	0.50	6.0	-	-	-	40	0.40	4.8	-	-	-
SNMM 150616E-OR:T9415	1.6	265	0.50	6.0	-	-	-	250	0.50	6.0	-	-	-	-	-	-	-	-	-
SNMM 190612E-OR:T8430	1.2	150	0.45	8.0	80	0.41	8.0	125	0.45	8.0	-	-	-	30	0.36	6.4	-	-	-
SNMM 190612E-OR:T9325	1.2	190	0.45	8.0	110	0.41	8.0	180	0.45	8.0	-	-	-	40	0.36	6.4	-	-	-
SNMM 190612E-OR:T9335	1.2	165	0.45	8.0	95	0.41	8.0	-	-	-	-	-	-	35	0.36	6.4	-	-	-
SNMM 190612E-OR:T9415	1.2	250	0.45	8.0	-	-	-	235	0.45	8.0	-	-	-	-	-	-	-	-	-
SNMM 190616E-OR:6630	1.6	175	0.50	8.0	105	0.45	8.0	165	0.50	8.0	-	-	-	40	0.40	6.4	-	-	-
SNMM 190616E-OR:T8345	1.6	125	0.50	8.0	75	0.45	8.0	115	0.50	8.0	-	-	-	30	0.40	6.4	-	-	-
SNMM 190616E-OR:T8430	1.6	155	0.50	8.0	85	0.45	8.0	130	0.50	8.0	-	-	-	30	0.40	6.4	-	-	-
SNMM 190616E-OR:T9325	1.6	185	0.50	8.0	110	0.45	8.0	175	0.50	8.0	-	-	-	40	0.40	6.4	-	-	-
SNMM 190616E-OR:T9335	1.6	160	0.50	8.0	95	0.45	8.0	-	-	-	-	-	-	35	0.40	6.4	-	-	-
SNMM 190616E-OR:T9415	1.6	260	0.50	8.0	-	-	-	245	0.50	8.0	-	-	-	-	-	-	-	-	-
SNMM 190624E-OR:T9325	2.4	165	0.80	8.0	95	0.72	8.0	155	0.80	8.0	-	-	-	35	0.56	6.4	-	-	-
SNMM 190624E-OR:T9415	2.4	225	0.80	8.0	-	-	-	210	0.80	8.0	-	-	-	-	-	-	-	-	-
SNMM 250716E-OR:T9226	1.6	115	0.50	12.0	65	0.45	12.0	105	0.50	12.0	-	-	-	20	0.45	9.6	-	-	-
SNMM 250716E-OR:T9325	1.6	120	0.55	12.0	70	0.50	12.0	110	0.55	12.0	-	-	-	25	0.50	9.6	-	-	-
SNMM 250724E-OR:T8345	2.4	55	1.00	12.0	30	0.90	12.0	50	1.00	12.0	-	-	-	10	0.70	9.6	-	-	-
SNMM 250724E-OR:T8430	2.4	80	1.00	12.0	45	0.90	12.0	65	1.00	12.0	-	-	-	15	0.70	9.6	-	-	-
SNMM 250724E-OR:T9325	2.4	100	1.00	12.0	60	0.90	12.0	95	1.00	12.0	-	-	-	20	0.70	9.6	-	-	-
SNMM 250724E-OR:T9335	2.4	80	1.00	12.0	45	0.90	12.0	-	-	-	-	-	-	15	0.70	9.6	-	-	-
SNMM 250724E-OR:T9415	2.4	120	1.00	12.0	-	-	-	110	1.00	12.0	-	-	-	-	-	-	-	-	-
SNMM 250924E-OR:T8430	2.4	80	1.00	12.0	45	0.90	12.0	65	1.00	12.0	-	-	-	15	0.70	9.6	-	-	-
SNMM 250924E-OR:T9325	2.4	100	1.00	12.0	60	0.90	12.0	95	1.00	12.0	-	-	-	20	0.70	9.6	-	-	-
SNMM 250924E-OR:T9335	2.4	80	1.00	12.0	45	0.90	12.0	-	-	-	-	-	-	15	0.70	9.6	-	-	-
SNMM 250924E-OR:T9415	2.4	120	1.00	12.0	-	-	-	110	1.00	12.0	-	-	-	-	-	-	-	-	-

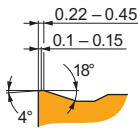
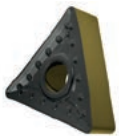

OR chip breaker is robust and the first choice for heavy roughing of Steels. It features positive rake angle and negative/stable, extra-wide double T-land. It's also suitable for Cast irons, and conditionally for Stainless steels and Super-alloys.

TNMM 160408E-OR:T9325	0.8	165	0.40	3.0	95	0.36	3.0	155	0.40	3.0	-	-	-	35	0.28	2.4	-	-	-
TNMM 160408E-OR:T9415	0.8	225	0.40	3.0	-	-	-	210	0.40	3.0	-	-	-	-	-	-	-	-	-
TNMM 220408E-OR:T9325	0.8	160	0.40	4.0	95	0.36	4.0	150	0.40	4.0	-	-	-	35	0.32	3.2	-	-	-
TNMM 220408E-OR:T9335	0.8	140	0.40	4.0	80	0.36	4.0	-	-	-	-	-	-	30	0.32	3.2	-	-	-
TNMM 220412E-OR:T9325	1.2	175	0.40	3.0	105	0.36	3.0	165	0.40	3.0	-	-	-	35	0.32	2.4	-	-	-
TNMM 220412E-OR:T9335	1.2	150	0.40	3.0	90	0.36	3.0	-	-	-	-	-	-	30	0.32	2.4	-	-	-

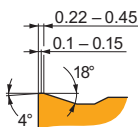

OR chip breaker is robust and the first choice for heavy roughing of Steels. It features positive rake angle and negative/stable, extra-wide double T-land. It's also suitable for Cast irons, and conditionally for Stainless steels and Super-alloys.

WNMM 080408E-OR:T8430	0.8	155	0.40	4.0	85	0.36	4.0	130	0.40	4.0	-	-	-	30	0.28	3.2	-	-	-
WNMM 080408E-OR:T9325	0.8	190	0.40	4.0	110	0.36	4.0	180	0.40	4.0	-	-	-	40	0.28	3.2	-	-	-
WNMM 080408E-OR:T9335	0.8	165	0.40	4.0	95	0.36	4.0	-	-	-	-	-	-	35	0.28	3.2	-	-	-
WNMM 080412E-OR:T9325	1.2	190	0.45	4.0	110	0.41	4.0	180	0.45	4.0	-	-	-	40	0.36	3.2	-	-	-
WNMM 080416E-OR:T9325	1.6	195	0.50	4.0	115	0.45	4.0	185	0.50	4.0	-	-	-	40	0.40	3.2	-	-	-
WNMM 130612E-OR:T9325	1.2	185	0.45	6.0	110	0.41	6.0	175	0.45	6.0	-	-	-	40	0.36	4.8	-	-	-
WNMM 130616E-OR:T9325	1.6	180	0.50	6.0	105	0.45	6.0	170	0.50	6.0	-	-	-	40	0.40	4.8	-	-	-

NR2

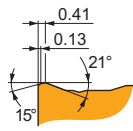

NR2 chip breaker is robust and the first choice for heavy roughing of Stainless steels. It features positive rake angle and negative/negative, extra-wide double T-land. It's also suitable for Steels, and conditionally for Cast irons and Super-alloys.



CNMM

	IC (mm)	D1 (mm)	L (mm)	S (mm)
1204	12.700	5.16	12.90	4.76
1606	15.875	6.35	16.10	6.35
1906	19.050	7.94	19.30	6.35
2509	25.400	9.12	25.80	9.53

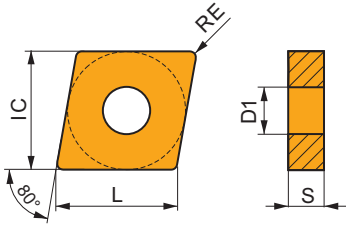

DNMM

	IC (mm)	D1 (mm)	L (mm)	S (mm)
1506	12.700	5.16	15.50	6.35

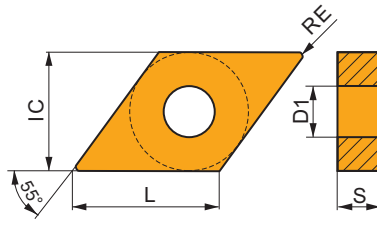

SNMM

	IC (mm)	D1 (mm)	L (mm)	S (mm)
1204	12.700	5.16	12.70	4.76
1506	15.875	6.35	15.88	6.35
1906	19.050	7.94	19.05	6.35
2507	25.400	9.12	25.40	7.94
2509	25.400	9.12	25.40	9.53

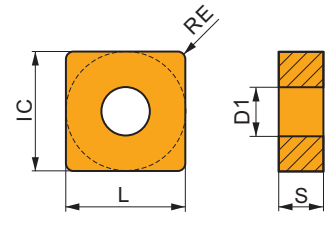

TNMM

	IC (mm)	D1 (mm)	L (mm)	S (mm)
1604	9.525	3.81	16.50	4.76
2204	12.700	5.16	22.00	4.76

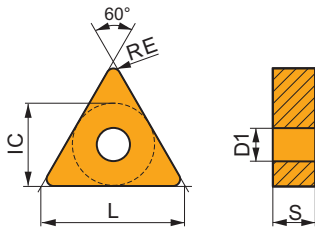

WNMM

	IC (mm)	D1 (mm)	L (mm)	S (mm)
0804	12.700	5.16	8.70	4.76

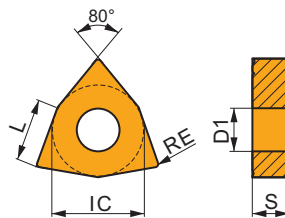

Suitability and starting values for cutting speed (vc), feed (f) and depth of cut (ap). Refer to our Machining Calculator app for further calculations.

Product	RE (mm)	P			M			K			N			S			H		
		vc (m/min)	f (mm/rev)	ap (mm)	vc (m/min)	f (mm/rev)	ap (mm)	vc (m/min)	f (mm/rev)	ap (mm)	vc (m/min)	f (mm/rev)	ap (mm)	vc (m/min)	f (mm/rev)	ap (mm)	vc (m/min)	f (mm/rev)	ap (mm)

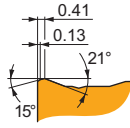
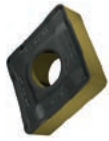

NR2 chip breaker is robust and the first choice for heavy roughing of Stainless steels. It features positive rake angle and negative/negative, extra-wide double T-land. It's also suitable for Steels, and conditionally for Cast irons and Super-alloys.

CNMM 120408E-NR2:T7325	0.8	165	0.40	5.0	125	0.36	5.0	-	-	-	-	-	-	50	0.28	4.0	-	-	-
CNMM 120408E-NR2:T7335	0.8	155	0.40	5.0	120	0.36	5.0	-	-	-	-	-	-	50	0.28	4.0	-	-	-
CNMM 120408E-NR2:T8430	0.8	150	0.40	5.0	80	0.36	5.0	125	0.40	5.0	-	-	-	30	0.28	4.0	-	-	-
CNMM 120408E-NR2:T9325	0.8	185	0.40	5.0	110	0.36	5.0	175	0.40	5.0	-	-	-	40	0.28	4.0	-	-	-
CNMM 120408E-NR2:T9415	0.8	250	0.40	5.0	-	-	-	235	0.40	5.0	-	-	-	-	-	-	-	-	-
CNMM 120412E-NR2:T7335	1.2	155	0.45	5.0	120	0.41	5.0	-	-	-	-	-	-	50	0.32	4.0	-	-	-
CNMM 120412E-NR2:T8430	1.2	150	0.45	5.0	80	0.41	5.0	125	0.45	5.0	-	-	-	30	0.32	4.0	-	-	-
CNMM 120412E-NR2:T9325	1.2	185	0.45	5.0	110	0.41	5.0	175	0.45	5.0	-	-	-	40	0.32	4.0	-	-	-
CNMM 160608E-NR2:T8430	0.8	150	0.40	6.0	80	0.36	6.0	125	0.40	6.0	-	-	-	30	0.32	4.8	-	-	-
CNMM 160608E-NR2:T9325	0.8	180	0.40	6.0	105	0.36	6.0	170	0.40	6.0	-	-	-	40	0.32	4.8	-	-	-
CNMM 160612E-NR2:T7325	1.2	165	0.45	6.0	125	0.41	6.0	-	-	-	-	-	-	50	0.36	4.8	-	-	-
CNMM 160612E-NR2:T7335	1.2	155	0.45	6.0	120	0.41	6.0	-	-	-	-	-	-	50	0.36	4.8	-	-	-
CNMM 160612E-NR2:T8430	1.2	150	0.45	6.0	80	0.41	6.0	125	0.45	6.0	-	-	-	30	0.36	4.8	-	-	-
CNMM 160612E-NR2:T9325	1.2	185	0.45	6.0	110	0.41	6.0	175	0.45	6.0	-	-	-	40	0.36	4.8	-	-	-
CNMM 160616E-NR2:T7325	1.6	165	0.50	6.0	125	0.45	6.0	-	-	-	-	-	-	50	0.40	4.8	-	-	-
CNMM 160616E-NR2:T7335	1.6	160	0.50	6.0	120	0.45	6.0	-	-	-	-	-	-	50	0.40	4.8	-	-	-
CNMM 160616E-NR2:T9325	1.6	180	0.50	6.0	105	0.45	6.0	170	0.50	6.0	-	-	-	40	0.40	4.8	-	-	-
CNMM 190612E-NR2:T7325	1.2	155	0.45	9.0	120	0.41	9.0	-	-	-	-	-	-	50	0.36	7.2	-	-	-
CNMM 190612E-NR2:T7335	1.2	145	0.45	9.0	110	0.41	9.0	-	-	-	-	-	-	45	0.36	7.2	-	-	-
CNMM 190612E-NR2:T8430	1.2	140	0.45	9.0	75	0.41	9.0	115	0.45	9.0	-	-	-	30	0.36	7.2	-	-	-
CNMM 190612E-NR2:T9325	1.2	175	0.45	9.0	105	0.41	9.0	165	0.45	9.0	-	-	-	35	0.36	7.2	-	-	-
CNMM 190616E-NR2:T7325	1.6	160	0.50	9.0	120	0.45	9.0	-	-	-	-	-	-	50	0.40	7.2	-	-	-
CNMM 190616E-NR2:T7335	1.6	150	0.50	9.0	115	0.45	9.0	-	-	-	-	-	-	45	0.40	7.2	-	-	-
CNMM 190616E-NR2:T8430	1.6	140	0.50	9.0	75	0.45	9.0	115	0.50	9.0	-	-	-	30	0.40	7.2	-	-	-
CNMM 190616E-NR2:T9325	1.6	175	0.50	9.0	105	0.45	9.0	165	0.50	9.0	-	-	-	35	0.40	7.2	-	-	-
CNMM 190616E-NR2:T9415	1.6	240	0.50	9.0	-	-	-	225	0.50	9.0	-	-	-	-	-	-	-	-	-
CNMM 190624E-NR2:T7335	2.4	130	0.80	9.0	100	0.72	9.0	-	-	-	-	-	-	40	0.56	7.2	-	-	-
CNMM 190624E-NR2:T9325	2.4	150	0.80	9.0	90	0.72	9.0	140	0.80	9.0	-	-	-	30	0.56	7.2	-	-	-
CNMM 250924E-NR2:T7335	2.4	95	0.80	12.0	70	0.72	12.0	-	-	-	-	-	-	30	0.56	9.6	-	-	-
CNMM 250924E-NR2:T8430	2.4	80	0.80	12.0	45	0.72	12.0	65	0.80	12.0	-	-	-	15	0.56	9.6	-	-	-
CNMM 250924E-NR2:T9325	2.4	100	0.80	12.0	60	0.72	12.0	95	0.80	12.0	-	-	-	20	0.56	9.6	-	-	-
CNMM 250924E-NR2:T9415	2.4	120	0.80	12.0	-	-	-	110	0.80	12.0	-	-	-	-	-	-	-	-	-

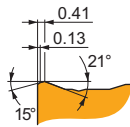

NR2 chip breaker is robust and the first choice for heavy roughing of Stainless steels. It features positive rake angle and negative/negative, extra-wide double T-land. It's also suitable for Steels, and conditionally for Cast irons and Super-alloys.

DNMM 150608E-NR2:T9325	0.8	155	0.40	3.0	90	0.36	3.0	145	0.40	3.0	-	-	-	30	0.32	2.4	-	-	-
------------------------	-----	-----	------	-----	----	------	-----	-----	------	-----	---	---	---	----	------	-----	---	---	---

Suitability and starting values for cutting speed (vc), feed (f) and depth of cut (ap). Refer to our Machining Calculator app for further calculations.

Product	RE (mm)	P			M			K			N			S			H		
		vc (m/min)	f (mm/rev)	ap (mm)	vc (m/min)	f (mm/rev)	ap (mm)	vc (m/min)	f (mm/rev)	ap (mm)	vc (m/min)	f (mm/rev)	ap (mm)	vc (m/min)	f (mm/rev)	ap (mm)	vc (m/min)	f (mm/rev)	ap (mm)

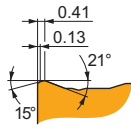
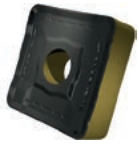

NR2 chip breaker is robust and the first choice for heavy roughing of Stainless steels. It features positive rake angle and negative/negative, extra-wide double T-land. It's also suitable for Steels, and conditionally for Cast irons and Super-alloys.

SNMM 120408E-NR2:T7325	0.8	175	0.40	4.7	135	0.36	4.7	-	-	-	-	-	-	55	0.32	3.8	-	-	-
SNMM 120408E-NR2:T7335	0.8	170	0.40	4.7	130	0.36	4.7	-	-	-	-	-	-	55	0.32	3.8	-	-	-
SNMM 120408E-NR2:T8430	0.8	165	0.40	4.7	90	0.36	4.7	135	0.40	4.7	-	-	-	35	0.32	3.8	-	-	-
SNMM 120408E-NR2:T9325	0.8	195	0.40	4.7	115	0.36	4.7	185	0.40	4.7	-	-	-	40	0.32	3.8	-	-	-
SNMM 120412E-NR2:T7335	1.2	165	0.45	4.7	125	0.41	4.7	-	-	-	-	-	-	50	0.36	3.8	-	-	-
SNMM 120412E-NR2:T8430	1.2	165	0.45	4.7	90	0.41	4.7	135	0.45	4.7	-	-	-	35	0.36	3.8	-	-	-
SNMM 120412E-NR2:T9325	1.2	200	0.45	4.7	120	0.41	4.7	190	0.45	4.7	-	-	-	45	0.36	3.8	-	-	-
SNMM 150612E-NR2:T7335	1.2	165	0.45	6.0	125	0.41	6.0	-	-	-	-	-	-	50	0.36	4.8	-	-	-
SNMM 150612E-NR2:T8430	1.2	165	0.45	6.0	90	0.41	6.0	135	0.45	6.0	-	-	-	35	0.36	4.8	-	-	-
SNMM 150612E-NR2:T9325	1.2	195	0.45	6.0	115	0.41	6.0	185	0.45	6.0	-	-	-	40	0.36	4.8	-	-	-
SNMM 150616E-NR2:T7335	1.6	165	0.50	6.0	125	0.45	6.0	-	-	-	-	-	-	50	0.40	4.8	-	-	-
SNMM 150616E-NR2:T9325	1.6	190	0.50	6.0	110	0.45	6.0	180	0.50	6.0	-	-	-	40	0.40	4.8	-	-	-
SNMM 190612E-NR2:T7335	1.2	160	0.45	8.0	120	0.41	8.0	-	-	-	-	-	-	50	0.36	6.4	-	-	-
SNMM 190612E-NR2:T9325	1.2	190	0.45	8.0	110	0.41	8.0	180	0.45	8.0	-	-	-	40	0.36	6.4	-	-	-
SNMM 190616E-NR2:T7325	1.6	175	0.50	8.0	135	0.45	8.0	-	-	-	-	-	-	55	0.40	6.4	-	-	-
SNMM 190616E-NR2:T7335	1.6	160	0.50	8.0	120	0.45	8.0	-	-	-	-	-	-	50	0.40	6.4	-	-	-
SNMM 190616E-NR2:T8430	1.6	155	0.50	8.0	85	0.45	8.0	130	0.50	8.0	-	-	-	30	0.40	6.4	-	-	-
SNMM 190616E-NR2:T9325	1.6	185	0.50	8.0	110	0.45	8.0	175	0.50	8.0	-	-	-	40	0.40	6.4	-	-	-
SNMM 190616E-NR2:T9415	1.6	260	0.50	8.0	-	-	-	245	0.50	8.0	-	-	-	-	-	-	-	-	-
SNMM 190624E-NR2:T7325	2.4	155	0.80	8.0	120	0.72	8.0	-	-	-	-	-	-	50	0.56	6.4	-	-	-
SNMM 190624E-NR2:T7335	2.4	145	0.80	8.0	110	0.72	8.0	-	-	-	-	-	-	45	0.56	6.4	-	-	-
SNMM 190624E-NR2:T9325	2.4	165	0.80	8.0	95	0.72	8.0	155	0.80	8.0	-	-	-	35	0.56	6.4	-	-	-
SNMM 250724E-NR2:T7335	2.4	100	0.80	12.0	75	0.72	12.0	-	-	-	-	-	-	30	0.56	9.6	-	-	-
SNMM 250724E-NR2:T8430	2.4	85	0.80	12.0	45	0.72	12.0	70	0.80	12.0	-	-	-	15	0.56	9.6	-	-	-
SNMM 250724E-NR2:T9226	2.4	95	0.80	12.0	55	0.72	12.0	90	0.80	12.0	-	-	-	20	0.56	9.6	-	-	-
SNMM 250724E-NR2:T9325	2.4	105	0.80	12.0	60	0.72	12.0	95	0.80	12.0	-	-	-	20	0.56	9.6	-	-	-
SNMM 250724E-NR2:T9415	2.4	125	0.80	12.0	-	-	-	115	0.80	12.0	-	-	-	-	-	-	-	-	-
SNMM 250924E-NR2:T7325	2.4	105	0.80	12.0	80	0.72	12.0	-	-	-	-	-	-	30	0.56	9.6	-	-	-
SNMM 250924E-NR2:T7335	2.4	100	0.80	12.0	75	0.72	12.0	-	-	-	-	-	-	30	0.56	9.6	-	-	-
SNMM 250924E-NR2:T9325	2.4	105	0.80	12.0	60	0.72	12.0	95	0.80	12.0	-	-	-	20	0.56	9.6	-	-	-
SNMM 250924E-NR2:T9415	2.4	125	0.80	12.0	-	-	-	115	0.80	12.0	-	-	-	-	-	-	-	-	-

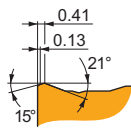
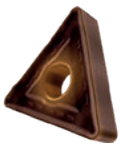

NR2 chip breaker is robust and the first choice for heavy roughing of Stainless steels. It features positive rake angle and negative/negative, extra-wide double T-land. It's also suitable for Steels, and conditionally for Cast irons and Super-alloys.

TNMM 160408E-NR2:T9325	0.8	165	0.40	3.0	95	0.36	3.0	155	0.40	3.0	-	-	-	35	0.28	2.4	-	-	-
TNMM 220408E-NR2:T9325	0.8	160	0.40	4.0	95	0.36	4.0	150	0.40	4.0	-	-	-	35	0.28	3.2	-	-	-
TNMM 220412E-NR2:T8430	1.2	140	0.40	4.0	75	0.36	4.0	115	0.40	4.0	-	-	-	30	0.32	3.2	-	-	-
TNMM 220412E-NR2:T9325	1.2	170	0.40	4.0	100	0.36	4.0	160	0.40	4.0	-	-	-	35	0.32	3.2	-	-	-

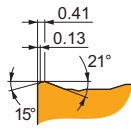

NR2 chip breaker is robust and the first choice for heavy roughing of Stainless steels. It features positive rake angle and negative/negative, extra-wide double T-land. It's also suitable for Steels, and conditionally for Cast irons and Super-alloys.

WNMM 080408E-NR2:T7335	0.8	160	0.40	4.0	120	0.36	4.0	-	-	-	-	-	-	50	0.28	3.2	-	-	-
WNMM 080408E-NR2:T9325	0.8	190	0.40	4.0	110	0.36	4.0	180	0.40	4.0	-	-	-	40	0.28	3.2	-	-	-
WNMM 080412E-NR2:T9325	1.2	190	0.45	4.0	110	0.41	4.0	180	0.45	4.0	-	-	-	40	0.32	3.2	-	-	-

HR

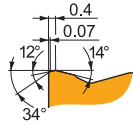

HR chip breaker is robust and designed for heavy roughing of Steels and Cast irons. It features slightly positive rake angle and negative/negative, extra-wide double T-land. It's also conditionally suitable for Stainless steels.



CNMM

	IC (mm)	D1 (mm)	L (mm)	S (mm)
1906	19.050	7.94	19.30	6.35
2509	25.400	9.12	25.80	9.53

SNMM

	IC (mm)	D1 (mm)	L (mm)	S (mm)
1906	19.050	7.94	19.05	6.35
2507	25.400	9.12	25.40	7.94
2509	25.400	9.12	25.40	9.53

TNMM

	IC (mm)	D1 (mm)	L (mm)	S (mm)
2706	15.875	6.35	27.50	6.35

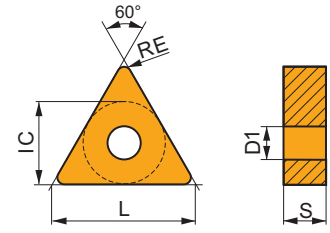
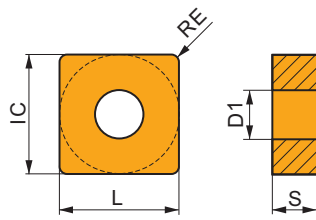
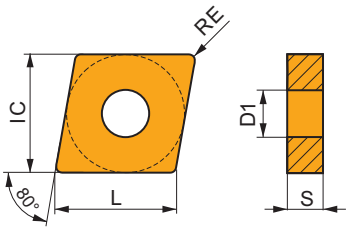

Suitability and starting values for cutting speed (vc), feed (f) and depth of cut (ap). Refer to our Machining Calculator app for further calculations.

Product	RE (mm)	P			M			K			N			S			H		
		vc (m/min)	f (mm/rev)	ap (mm)	vc (m/min)	f (mm/rev)	ap (mm)	vc (m/min)	f (mm/rev)	ap (mm)	vc (m/min)	f (mm/rev)	ap (mm)	vc (m/min)	f (mm/rev)	ap (mm)	vc (m/min)	f (mm/rev)	ap (mm)

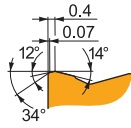
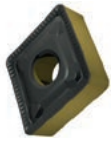

HR chip breaker is robust and designed for heavy roughing of Steels and Cast irons. It features slightly positive rake angle and negative/negative, extra-wide double T-land. It's also conditionally suitable for Stainless steels.

CNMM 190616E-HR:6630	1.6	85	0.60	10.0	50	0.54	10.0	80	0.60	10.0	-	-	-	-	-	-	-	-
CNMM 190616E-HR:6640	1.6	75	0.60	10.0	45	0.54	10.0	70	0.60	10.0	-	-	-	-	-	-	-	-
CNMM 190616E-HR:T8345	1.6	55	0.60	10.0	30	0.54	10.0	50	0.60	10.0	-	-	-	-	-	-	-	-
CNMM 190616E-HR:T9325	1.6	105	0.60	10.0	60	0.54	10.0	95	0.60	10.0	-	-	-	-	-	-	-	-
CNMM 190616E-HR:T9335	1.6	80	0.60	10.0	45	0.54	10.0	-	-	-	-	-	-	-	-	-	-	-
CNMM 190624E-HR:6630	2.4	90	0.65	10.0	50	0.59	10.0	85	0.65	10.0	-	-	-	-	-	-	-	-
CNMM 190624E-HR:T8345	2.4	60	0.65	10.0	35	0.59	10.0	55	0.65	10.0	-	-	-	-	-	-	-	-
CNMM 190624E-HR:T9325	2.4	100	0.65	10.0	60	0.59	10.0	95	0.65	10.0	-	-	-	-	-	-	-	-
CNMM 190624E-HR:T9335	2.4	85	0.65	10.0	50	0.59	10.0	-	-	-	-	-	-	-	-	-	-	-
CNMM 190624E-HR:T9415	2.4	120	0.65	10.0	-	-	-	110	0.65	10.0	-	-	-	-	-	-	-	-
CNMM 250924E-HR:6630	2.4	85	0.65	14.0	50	0.59	14.0	80	0.65	14.0	-	-	-	-	-	-	-	-
CNMM 250924E-HR:6640	2.4	75	0.65	14.0	45	0.59	14.0	70	0.65	14.0	-	-	-	-	-	-	-	-
CNMM 250924E-HR:T8345	2.4	55	0.65	14.0	30	0.59	14.0	50	0.65	14.0	-	-	-	-	-	-	-	-
CNMM 250924E-HR:T9315	2.4	110	0.65	14.0	-	-	-	100	0.65	14.0	-	-	-	-	-	-	-	-
CNMM 250924E-HR:T9325	2.4	100	0.65	14.0	60	0.59	14.0	95	0.65	14.0	-	-	-	-	-	-	-	-
CNMM 250924E-HR:T9335	2.4	80	0.65	14.0	45	0.59	14.0	-	-	-	-	-	-	-	-	-	-	-
CNMM 250924E-HR:T9415	2.4	120	0.65	14.0	-	-	-	110	0.65	14.0	-	-	-	-	-	-	-	-

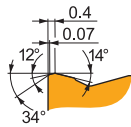
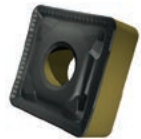

HR chip breaker is robust and designed for heavy roughing of Steels and Cast irons. It features slightly positive rake angle and negative/negative, extra-wide double T-land. It's also conditionally suitable for Stainless steels.

SNMM 190616E-HR:6630	1.6	90	0.60	9.0	50	0.54	9.0	85	0.60	9.0	-	-	-	-	-	-	-	-
SNMM 190616E-HR:T8345	1.6	60	0.60	9.0	35	0.54	9.0	55	0.60	9.0	-	-	-	-	-	-	-	-
SNMM 190616E-HR:T9325	1.6	110	0.60	9.0	65	0.54	9.0	100	0.60	9.0	-	-	-	-	-	-	-	-
SNMM 190616E-HR:T9335	1.6	85	0.60	9.0	50	0.54	9.0	-	-	-	-	-	-	-	-	-	-	-
SNMM 190624E-HR:T9315	2.4	120	0.65	9.0	-	-	-	110	0.65	9.0	-	-	-	-	-	-	-	-
SNMM 190624E-HR:T9325	2.4	115	0.65	9.0	65	0.59	9.0	105	0.65	9.0	-	-	-	-	-	-	-	-
SNMM 190624E-HR:T9335	2.4	90	0.65	9.0	50	0.59	9.0	-	-	-	-	-	-	-	-	-	-	-
SNMM 190624E-HR:T9415	2.4	130	0.65	9.0	-	-	-	120	0.65	9.0	-	-	-	-	-	-	-	-
SNMM 250716E-HR:T8345	1.6	60	0.60	13.0	35	0.54	13.0	55	0.60	13.0	-	-	-	-	-	-	-	-
SNMM 250716E-HR:T9325	1.6	100	0.60	13.0	60	0.54	13.0	95	0.60	13.0	-	-	-	-	-	-	-	-
SNMM 250716E-HR:T9335	1.6	85	0.60	13.0	50	0.54	13.0	-	-	-	-	-	-	-	-	-	-	-
SNMM 250724E-HR:6630	2.4	90	0.65	13.0	50	0.59	13.0	85	0.65	13.0	-	-	-	-	-	-	-	-
SNMM 250724E-HR:6640	2.4	80	0.65	13.0	45	0.59	13.0	75	0.65	13.0	-	-	-	-	-	-	-	-
SNMM 250724E-HR:T8345	2.4	55	0.65	13.0	30	0.59	13.0	50	0.65	13.0	-	-	-	-	-	-	-	-
SNMM 250724E-HR:T9325	2.4	105	0.65	13.0	60	0.59	13.0	95	0.65	13.0	-	-	-	-	-	-	-	-
SNMM 250724E-HR:T9335	2.4	85	0.65	13.0	50	0.59	13.0	-	-	-	-	-	-	-	-	-	-	-
SNMM 250724E-HR:T9415	2.4	125	0.65	13.0	-	-	-	115	0.65	13.0	-	-	-	-	-	-	-	-
SNMM 250732E-HR:T9325	3.2	95	0.80	13.0	55	0.72	13.0	90	0.80	13.0	-	-	-	-	-	-	-	-
SNMM 250924E-HR:6630	2.4	90	0.65	13.0	50	0.59	13.0	85	0.65	13.0	-	-	-	-	-	-	-	-
SNMM 250924E-HR:T8345	2.4	55	0.65	13.0	30	0.59	13.0	50	0.65	13.0	-	-	-	-	-	-	-	-
SNMM 250924E-HR:T9325	2.4	105	0.65	13.0	60	0.59	13.0	95	0.65	13.0	-	-	-	-	-	-	-	-
SNMM 250924E-HR:T9335	2.4	85	0.65	13.0	50	0.59	13.0	-	-	-	-	-	-	-	-	-	-	-
SNMM 250924E-HR:T9415	2.4	125	0.65	13.0	-	-	-	115	0.65	13.0	-	-	-	-	-	-	-	-
SNMM 250932E-HR:T9325	3.2	95	0.80	13.0	55	0.72	13.0	90	0.80	13.0	-	-	-	-	-	-	-	-

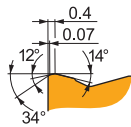

HR chip breaker is robust and designed for heavy roughing of Steels and Cast irons. It features slightly positive rake angle and negative/negative, extra-wide double T-land. It's also conditionally suitable for Stainless steels.

TNMM 270616E-HR:T9325	1.6	90	0.60	7.0	50	0.54	7.0	85	0.60	7.0	-	-	-	-	-	-	-	-
TNMM 270616E-HR:T9335	1.6	75	0.60	7.0	45	0.54	7.0	-	-	-	-	-	-	-	-	-	-	-
TNMM 270624E-HR:T9226	2.4	80	0.65	7.0	45	0.59	7.0	75	0.65	7.0	-	-	-	-	-	-	-	-

HR2

HR2 chip breaker is robust and designed for heavy roughing of Steels and Cast irons. It features positive rake angle and stable, extra-wide double T-land. It's also conditionally suitable for Stainless steels.

PRAMET

923

923 chip breaker is robust and designed for heavy roughing of Stainless steels. It features positive rake angle and negative/stable, extra-wide double T-land. It's also conditionally suitable for Steels and Cast irons.

PRAMET

CNMM

	IC	D1	L	S
	(mm)	(mm)	(mm)	(mm)
1906	19.050	7.94	19.30	6.35
2509	25.400	9.12	25.80	9.53

SNMM

	IC	D1	L	S
	(mm)	(mm)	(mm)	(mm)
1906	19.050	7.94	19.05	6.35
2507	25.400	9.12	25.40	7.94
2509	25.400	9.12	25.40	9.53

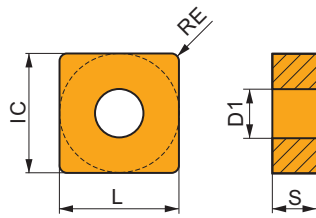
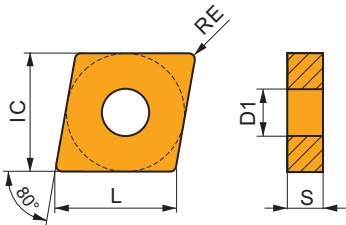

Suitability and starting values for cutting speed (vc), feed (f) and depth of cut (ap). Refer to our Machining Calculator app for further calculations.

Product	RE (mm)	P			M			K			N			S			H		
		vc (m/min)	f (mm/rev)	ap (mm)	vc (m/min)	f (mm/rev)	ap (mm)	vc (m/min)	f (mm/rev)	ap (mm)	vc (m/min)	f (mm/rev)	ap (mm)	vc (m/min)	f (mm/rev)	ap (mm)	vc (m/min)	f (mm/rev)	ap (mm)

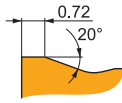
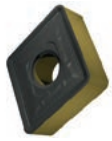

HR2 chip breaker is robust and designed for heavy roughing of Steels and Cast irons. It features positive rake angle and stable, extra-wide double T-land. It's also conditionally suitable for Stainless steels.

CNMM 190616-HR2:T9226	1.6	85	0.65	10.0	50	0.59	10.0	80	0.65	10.0	-	-	-	-	-	-	-	-
CNMM 190616-HR2:T9335	1.6	80	0.65	10.0	45	0.59	10.0	-	-	-	-	-	-	-	-	-	-	-
CNMM 190616-HR2:T9415	1.6	115	0.65	10.0	-	-	-	105	0.65	10.0	-	-	-	-	-	-	-	-
CNMM 190624-HR2:T9226	2.4	80	0.85	10.0	45	0.77	10.0	75	0.85	10.0	-	-	-	-	-	-	-	-
CNMM 190624-HR2:T9415	2.4	110	0.85	10.0	-	-	-	100	0.85	10.0	-	-	-	-	-	-	-	-
CNMM 250924-HR2:T9315	2.4	100	0.85	12.0	-	-	-	95	0.85	12.0	-	-	-	-	-	-	-	-
CNMM 250924-HR2:T9335	2.4	75	0.85	12.0	45	0.77	12.0	-	-	-	-	-	-	-	-	-	-	-
CNMM 250924-HR2:T9415	2.4	110	0.85	12.0	-	-	-	100	0.85	12.0	-	-	-	-	-	-	-	-

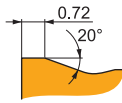
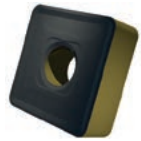

HR2 chip breaker is robust and designed for heavy roughing of Steels and Cast irons. It features positive rake angle and stable, extra-wide double T-land. It's also conditionally suitable for Stainless steels.

SNMM 190616-HR2:T9335	1.6	85	0.65	8.9	50	0.59	8.9	-	-	-	-	-	-	-	-	-	-	-
SNMM 190616-HR2:T9415	1.6	125	0.65	8.9	-	-	-	115	0.65	8.9	-	-	-	-	-	-	-	-
SNMM 190624-HR2:T9335	2.4	80	0.85	8.9	45	0.77	8.9	-	-	-	-	-	-	-	-	-	-	-
SNMM 190624-HR2:T9415	2.4	120	0.85	8.9	-	-	-	110	0.85	8.9	-	-	-	-	-	-	-	-
SNMM 250724-HR2:T9226	2.4	85	0.85	11.0	50	0.77	11.0	80	0.85	11.0	-	-	-	-	-	-	-	-
SNMM 250724-HR2:T9335	2.4	80	0.85	11.0	45	0.77	11.0	-	-	-	-	-	-	-	-	-	-	-
SNMM 250924-HR2:T9226	2.4	85	0.85	11.0	50	0.77	11.0	80	0.85	11.0	-	-	-	-	-	-	-	-
SNMM 250924-HR2:T9315	2.4	105	0.85	11.0	-	-	-	95	0.85	11.0	-	-	-	-	-	-	-	-
SNMM 250924-HR2:T9335	2.4	80	0.85	11.0	45	0.77	11.0	-	-	-	-	-	-	-	-	-	-	-
SNMM 250924-HR2:T9415	2.4	115	0.85	11.0	-	-	-	105	0.85	11.0	-	-	-	-	-	-	-	-
SNMM 250932-HR2:T9335	3.2	75	1.00	11.0	45	0.90	11.0	-	-	-	-	-	-	-	-	-	-	-

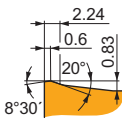
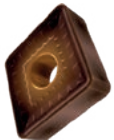

923 chip breaker is robust and designed for heavy roughing of Stainless steels. It features positive rake angle and negative/stable, extra-wide double T-land. It's also conditionally suitable for Steels and Cast irons.

CNMM 250924S-923:T8430	2.4	75	0.85	12.0	40	0.77	12.0	60	0.85	12.0	-	-	-	15	0.60	9.6	-	-	-
CNMM 250924S-923:T9335	2.4	75	0.85	12.0	45	0.77	12.0	-	-	-	-	-	-	15	0.60	9.6	-	-	-

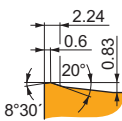

923 chip breaker is robust and designed for heavy roughing of Stainless steels. It features positive rake angle and negative/stable, extra-wide double T-land. It's also conditionally suitable for Steels and Cast irons.

SNMM 190616S-923:T8345	1.6	100	0.65	8.9	60	0.59	8.9	95	0.65	8.9	-	-	-	25	0.52	7.1	-	-	-
SNMM 190616S-923:T8430	1.6	125	0.65	8.9	65	0.59	8.9	100	0.65	8.9	-	-	-	25	0.52	7.1	-	-	-
SNMM 190616S-923:T9335	1.6	130	0.65	8.9	75	0.59	8.9	-	-	-	-	-	-	25	0.52	7.1	-	-	-
SNMM 250724S-923:T8430	2.4	80	0.85	11.0	45	0.77	11.0	65	0.85	11.0	-	-	-	15	0.60	8.8	-	-	-
SNMM 250724S-923:T9335	2.4	80	0.85	11.0	45	0.77	11.0	-	-	-	-	-	-	15	0.60	8.8	-	-	-
SNMM 250924S-923:T8345	2.4	55	0.85	11.0	30	0.77	11.0	50	0.85	11.0	-	-	-	10	0.60	8.8	-	-	-
SNMM 250924S-923:T8430	2.4	80	0.85	11.0	45	0.77	11.0	65	0.85	11.0	-	-	-	15	0.60	8.8	-	-	-
SNMM 250924S-923:T9226	2.4	85	0.85	11.0	50	0.77	11.0	80	0.85	11.0	-	-	-	15	0.60	8.8	-	-	-
SNMM 250924S-923:T9335	2.4	80	0.85	11.0	45	0.77	11.0	-	-	-	-	-	-	15	0.60	8.8	-	-	-
SNMM 250924S-923:T9415	2.4	115	0.85	11.0	-	-	-	105	0.85	11.0	-	-	-	-	-	-	-	-	-

CN

ISO TURNING – EXTERNAL – NAVIGATOR

DCBN(RL) EXT 75° CN.. 246	DCKN(RL) EXT 75° CN.. 248	DCLN(RL) EXT 95° CN.. 249	PCBN(RL) EXT 75° CN.. 251
PCKN(RL) EXT 75° CN.. 252	PCLN(RL) EXT 95° CN.. 253	C.-DCLN(RL) EXT 95° CN.. 254	

CN

ISO TURNING – HEAVY ROUGHING – NAVIGATOR

KHP-CBNR 75° CN.. 256	KHP-CBNL 75° CN.. 257	KHP-CLNR 95° CN.. 257	DKH(RL) 258
--	--	--	---------------------------

CN

ISO TURNING – INTERNAL – NAVIGATOR

DCLN(RL) INT 95° CN.. 259	PCLN(RL) INT 95° CN.. 260	C.-DCLN(RL) INT 95° CN.. 262
--	--	---

DN

ISO TURNING – EXTERNAL – NAVIGATOR

<p>DDJN(RL) EXT 93°</p> <p>DN..</p> <p>263</p>	<p>PDJN(RL) EXT 93°</p> <p>DN..</p> <p>264</p>	<p>PDNN(RL) EXT 62°30'</p> <p>DN..</p> <p>265</p>	<p>PDXN(RL) EXT 98°</p> <p>DN..</p> <p>266</p>
<p>C-DDJN(RL) EXT 93°</p> <p>DN..</p> <p>267</p>	<p>C-DDNNN EXT 62.5°</p> <p>DN..</p> <p>268</p>	<p>C-DDUN(RL) EXT 93°</p> <p>DN..</p> <p>269</p>	

DN

ISO TURNING – INTERNAL – NAVIGATOR

<p>DDUN(RL) INT 93°</p> <p>DN..</p> <p>270</p>	<p>PDUN(RL) INT 93°</p> <p>DN..</p> <p>271</p>	<p>C-DDUN(RL) INT 93°</p> <p>DN..</p> <p>272</p>
---	---	---

KN

ISO TURNING – EXTERNAL – NAVIGATOR

CKJN(RL) EXT 93°

KN..

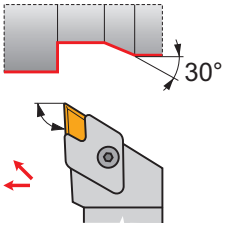

273

LN

ISO TURNING – EXTERNAL – NAVIGATOR

PLBN(RL) EXT 75°

LN..

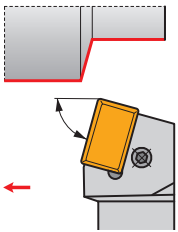

274

LN

ISO TURNING – HEAVY ROUGHING – NAVIGATOR

KHP-LBNR 75°

LN..

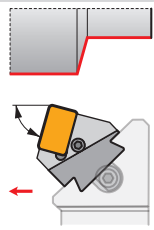

275

KHP-LBNL 75°

LN..

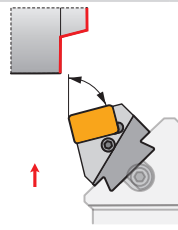

275

DKH(RL)

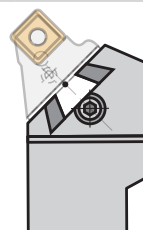

276

RN

ISO TURNING – EXTERNAL – NAVIGATOR

DRSN(RL) EXT

RN..

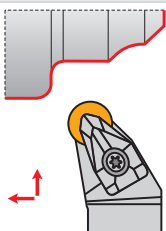

277

PRSN(RL) EXT

RN..

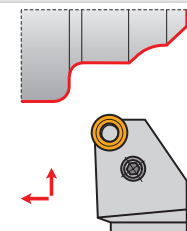

278

C.-DRSN(RL) EXT

RN..

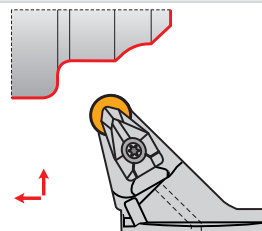

279

SN

ISO TURNING – EXTERNAL – NAVIGATOR

DSBN(RL) EXT 45° SN.. 280	DSDNN EXT 45° SN.. 281	DSKN(RL) EXT 75° SN.. 282	DSSN(RL) EXT 45° SN.. 283
PSBN(RL) EXT 75° SN.. 285	PSDNN EXT 45° SN.. 287	PSKN(RL) EXT 75° SN.. 288	PSSN(RL) EXT 45° SN.. 290
C.-DSDNN EXT 45° SN.. 291	C.-DSKN(RL) EXT 75° SN.. 292	C.-DSRN(RL) EXT 75° SN.. 293	C.-DSSN(RL) EXT 45° SN.. 294

SN

ISO TURNING – HEAVY ROUGHING – NAVIGATOR

KHP-SBNR 75° SN.. 295	KHP-SBNL 75° SN.. 295	KHP-SSNR/L 45° SN.. 296	DKH(RL) 297
-------------------------------------	-------------------------------------	---------------------------------------	---------------------------

SN

ISO TURNING – INTERNAL – NAVIGATOR

PSKN(RL) INT 75° SN.. 298

TN

ISO TURNING – EXTERNAL – NAVIGATOR

<p>DTFN(RL) EXT 90°</p> <p>TN..</p> <p>↑</p> <p>306</p>	<p>DTGN(RL) EXT 90°</p> <p>TN..</p> <p>←</p> <p>300</p>	<p>MTJN(RL) EXT 93°</p> <p>TN..</p> <p>↕</p> <p>22°</p> <p>301</p>	<p>PTFN(RL) EXT 90°</p> <p>TN..</p> <p>↑</p> <p>302</p>
<p>PTGN(RL) EXT 90°</p> <p>TN..</p> <p>←</p> <p>303</p>	<p>PTTN(RL) EXT 60°</p> <p>TN..</p> <p>↕</p> <p>30°</p> <p>304</p>	<p>C.-DTJN(RL) EXT 93°</p> <p>TN..</p> <p>←</p> <p>305</p>	

TN

ISO TURNING – INTERNAL – NAVIGATOR

<p>DTFN(RL) INT 90°</p> <p>TN..</p> <p>306</p>	<p>PTFN(RL) INT 90°</p> <p>TN..</p> <p>←</p> <p>307</p>	<p>C.-DTFN(RL) INT 91°</p> <p>TN..</p> <p>308</p>
---	--	--

VN

ISO TURNING – EXTERNAL – NAVIGATOR

DVJN(RL) EXT 93° 	DVPN(RL) EXT 62°30' 	MVJN(RL) EXT 93° 	C.-DVJN(RL) EXT 93°
-----------------------------	--------------------------------	-----------------------------	--------------------------------

VN

ISO TURNING – INTERNAL – NAVIGATOR

DVUN(RL) INT

WN

ISO TURNING – EXTERNAL – NAVIGATOR

DWLN(RL) EXT 95° 	MWLN(RL) EXT 95° 	PWLN(RL) EXT 95° 	C.-DWLN(RL) EXT 95°
-----------------------------	-----------------------------	-----------------------------	--------------------------------

WN

ISO TURNING – INTERNAL – NAVIGATOR

DWLN(RL) INT 95° 	PWLN(RL) INT 95° 	C.-DWLN(RL) INT 95°
-----------------------------	-----------------------------	--------------------------------

DCBN(RL) EXT



PRAMET

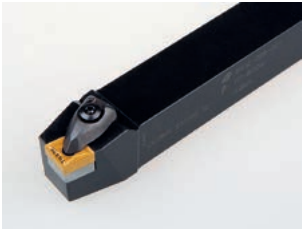

External Double Clamp Turning Holder with 75° Cutting Angle for CN.. Inserts



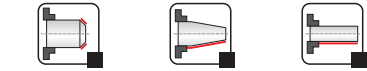
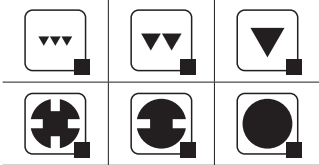
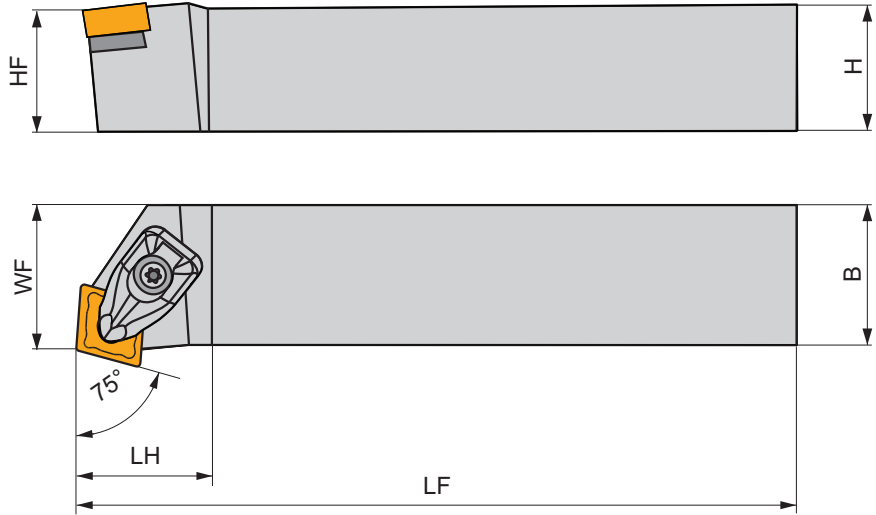
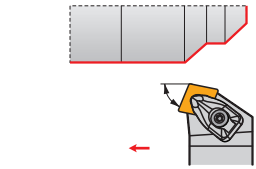

External Right/Left hand double clamp 75° tool holder. Suited for longitudinal and face turning without shoulder and chamfering with negative CN.. inserts. Body treated for longer tool life.



	Product	H	B	HF	WF	LF	LH	LAMS	GAMO	kg			
		(mm)	(mm)	(mm)	(mm)	(mm)	(mm)	(°)	(°)				
R	DCBNR 2020 K 12	20	20	20	17	125	34.2	-6	-6	0.43	GI043	DC12	AT001
	DCBNR 2525 M 12	25	25	25	22	150	34.6	-6	-6	0.76	GI043	DC12	AT001
	DCBNR 3225 P 12	32	25	32	22	170	34.6	-6	-6	1.09	GI043	DC12	AT001
	DCBNR 2525 M 16	25	25	25	22	150	41.5	-6	-6	0.80	GI050	DC16	AT005
	DCBNR 3225 P 16	32	25	32	22	170	32.0	-6	-6	1.11	GI050	DC16	AT005
	DCBNR 3232 P 19	32	32	32	27	170	46.1	-6	-6	1.39	GI042	DC19	-
L	DCBNL 2525 M 12	25	25	25	22	150	34.6	-6	-6	0.76	GI043	DC12	AT001
	DCBNL 3225 P 12	32	25	32	22	170	34.6	-6	-6	1.09	GI043	DC12	AT001
	DCBNL 2525 M 16	25	25	25	22	150	41.5	-6	-6	0.79	GI050	DC16	AT005
	DCBNL 3225 P 16	32	25	32	22	170	32.0	-6	-6	1.11	GI050	DC16	AT005
	DCBNL 3232 P 19	32	32	32	27	170	46.1	-6	-6	1.39	GI042	DC19	-

GI042	CN.. 1906..
GI043	CN.. 1204..
GI050	CN.. 1606..

DC12	DCS 12	3.9	DCS 234-01	US 2002-T15P	FLAG T15P/3,5	-
DC16	DCS 16	6.4	DCS 234-03	US 2007-T20P	-	LKT20P
DC19	DCS 19	6.4	DCS 236-01	US 2007-T20P	-	LKT20P

			
AT001a	CN.. 1207..	-	DCS 234-02
AT005a	CN.. 1607..	-	DCS 234-04
AT001b	CER CN.N 1204..	DCS 12C4	-
AT001c	CER CN.A 1204..	DCS 12C2	-
AT005b	CER CN.N 1606..	DCS 16C4	-
AT005c	CER CN.A 1606..	DCS 16C2	-

DCKN(RL) EXT



PRAMET



External Double Clamp Holder, 75° (Face) Cutting Angle for CN.. Inserts

External Right/Left hand double clamp 75° tool holder. Suited for face turning and occasionally chamfering with negative CN.. inserts. Body treated for longer tool life.

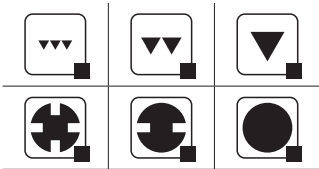
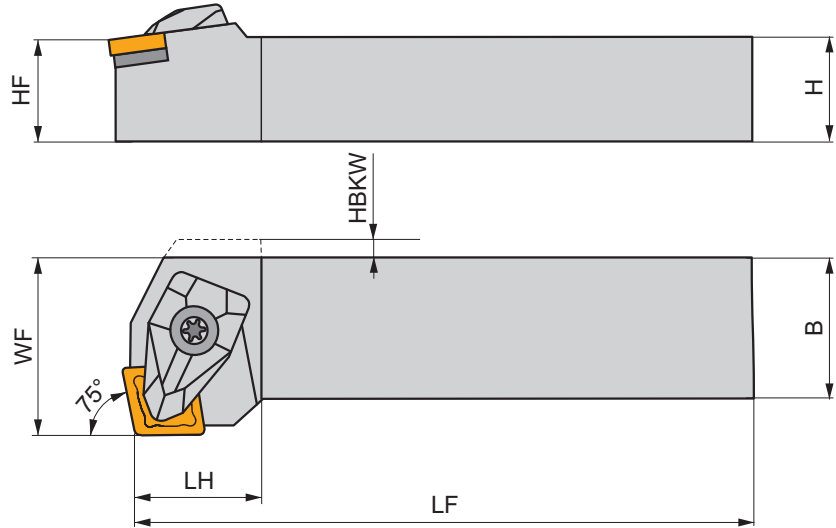
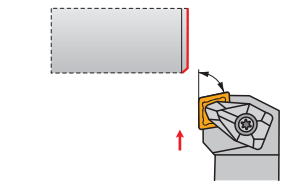

Product	H	B	HF	WF	LF	LH	HBKW	LAMS	GAMO	kg			
	(mm)	(mm)	(mm)	(mm)	(mm)	(mm)	(mm)	(°)	(°)				
R DCKNR 2020 K 12	20	20	20	25	125	21.2	4.5	-6	-6	0.46	GI043	DC12	AT001
DCKNR 2525 M 12	25	25	25	32	150	21.1	-	-6	-6	0.80	GI043	DC12	AT001
DCKNR 3225 P 12	32	25	32	32	170	21.1	-	-6	-6	1.14	GI043	DC12	AT001
DCKNR 3232 P 16	32	32	32	40	170	26.0	-	-6	-6	1.46	GI050	DC16	AT005
L DCKNL 2525 M 12	25	25	25	32	150	21.1	-	-6	-6	0.80	GI043	DC12	AT001
DCKNL 3225 P 12	32	25	32	32	170	21.1	-	-6	-6	1.13	GI043	DC12	AT001
DCKNL 3232 P 16	32	32	32	40	170	26.0	-	-6	-6	1.45	GI050	DC16	AT005

GI043	CN.. 1204..
GI050	CN.. 1606..

DC12	DCS 12	3.9	DCS 234-01	US 2002-T15P	FLAGT15P/3,5	-
DC16	DCS 16	6.4	DCS 234-03	US 2007-T20P	-	LKT20P

AT001a	CN.. 1207..	-	DCS 234-02
AT005a	CN.. 1607..	-	DCS 234-04
AT001b	CER CN.N 1204..	DCS 12C4	-
AT001c	CER CN.A 1204..	DCS 12C2	-

AT005b	CER CN.N 1606..	DCS 16C4	-
AT005c	CER CN.A 1606..	DCS 16C2	-

DCLN(RL) EXT



PRAMET





External Double Clamp Turning Holder with 95° Cutting Angle for CN.. Inserts

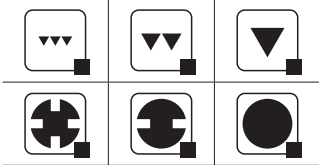
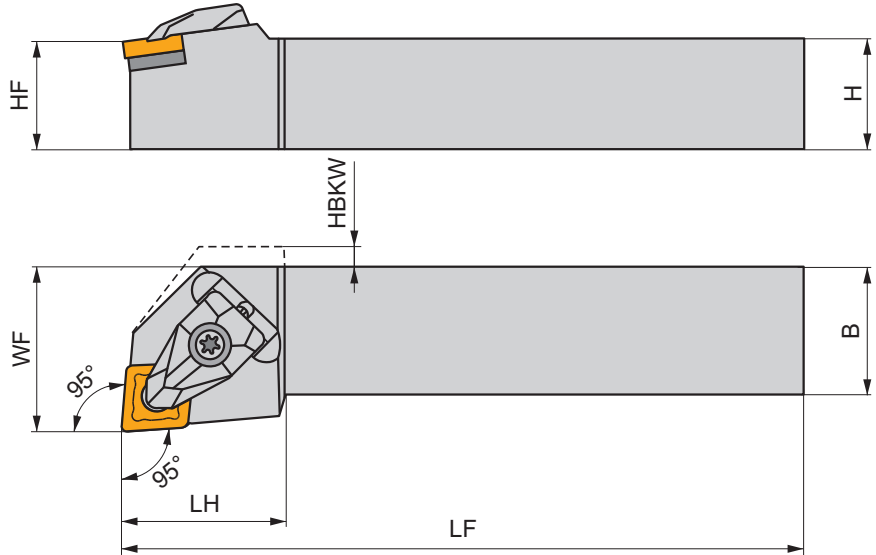
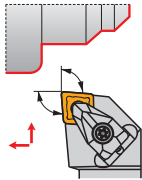





External Right/Left hand double clamp 95° tool holder. Suited for longitudinal turning, chamfering and facing with shoulder, using negative CN.. inserts and. Body treated for longer tool life.







Product	H	B	HF	WF	LF	LH	HBKW	LAMS	GAMO	kg			
	(mm)	(mm)	(mm)	(mm)	(mm)	(mm)	(mm)	(°)	(°)				
R DCLNR 1616 H 09	16	16	16	20	100	25.0	-	-6	-6	0.24	G1133	DC09	-
DCLNR 2020 K 09	20	20	20	25	125	25.0	-	-6	-6	0.44	G1133	DC09	-
DCLNR 2525 M 09	25	25	25	32	150	25.0	-	-6	-6	0.77	G1133	DC09	-
DCLNR 1616 H 12	16	16	16	20	100	32.3	4.5	-6	-6	0.26	G1043	DC112	AT001
DCLNR 2020 K 12	20	20	20	25	125	30.0	-	-6	-6	0.44	G1043	DC12	AT001
DCLNR 2525 M 12	25	25	25	32	150	30.0	-	-6	-6	0.78	G1043	DC12	AT001
DCLNR 3225 P 12	32	25	32	32	170	30.0	-	-6	-6	1.07	G1043	DC12	AT001
DCLNR 2525 M 16	25	25	25	32	150	39.0	-	-6	-6	0.81	G1050	DC16	AT005
DCLNR 3225 P 16	32	25	32	32	170	35.0	-	-6	-6	1.13	G1050	DC16	AT005
DCLNR 3232 P 19	32	32	32	40	170	40.0	-	-6	-6	1.40	G1042	DC19	-
DCLNR 4040 S 19	40	40	40	50	250	43.4	-	-6	-6	3.20	G1042	DC19	-
L DCLNL 1616 H 09	16	16	16	20	100	24.8	-	-6	-6	0.22	G1133	DC09	-
DCLNL 2020 K 09	20	20	20	25	125	24.8	-	-6	-6	0.42	G1133	DC09	-
DCLNL 2525 M 09	25	25	25	32	150	24.8	-	-6	-6	0.76	G1133	DC09	-
DCLNL 1616 H 12	16	16	16	20	100	32.2	4.5	-6	-6	0.26	G1043	DC112	AT001
DCLNL 2020 K 12	20	20	20	25	125	32.0	-	-6	-6	0.44	G1043	DC12	AT001
DCLNL 2525 M 12	25	25	25	32	150	32.0	-	-6	-6	0.78	G1043	DC12	AT001
DCLNL 3225 P 12	32	25	32	32	170	32.0	-	-6	-6	1.10	G1043	DC12	AT001
DCLNL 2525 M 16	25	25	25	32	150	39.0	-	-6	-6	0.81	G1050	DC16	AT005
DCLNL 3225 P 16	32	25	32	32	170	39.0	-	-6	-6	1.10	G1050	DC16	AT005
DCLNL 3232 P 19	32	32	32	40	170	43.2	-	-6	-6	1.41	G1042	DC19	-
DCLNL 4040 S 19	40	40	40	50	250	43.4	-	-6	-6	3.26	G1042	DC19	-

	G1042	CN.. 1906..
	G1043	CN.. 1204..

	
GI050	CN.. 1606..
GI133	CN.. 0903..

						
DC09	DCS 09	1.7	DCS 236-04	US 2004-T09P	FLAG T09P	-
DC12	DCS 12	3.9	DCS 234-01	US 2002-T15P	FLAG T15P/3,5	-
DC16	DCS 16	6.4	DCS 234-03	US 2007-T20P	-	LKT20P
DC19	DCS 19	6.4	DCS 236-01	US 2007-T20P	-	LKT20P
DCI12	DCS 12	3.9	DCS 236-03	US 2002-T15P	FLAG T15P/3,5	-

			
AT001a	CN.. 1207..	-	DCS 234-02
AT005a	CN.. 1607..	-	DCS 234-04
AT001b	CER CN.N 1204..	DCS 12C4	-
AT001c	CER CN.A 1204..	DCS 12C2	-
AT005b	CER CN.N 1606..	DCS 16C4	-
AT005c	CER CN.A 1606..	DCS 16C2	-

PCBN(RL) EXT



PRAMET



External Lever Lock Turning Holder with 75° Cutting Angle for CN.. Inserts

External Right/Left hand lever lock 75° tool holder. Suited for external chamfering, taper and longitudinal turning without shoulder, using negative CN.. inserts. Body treated for longer tool life.

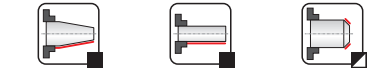
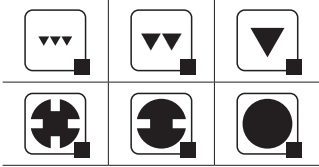
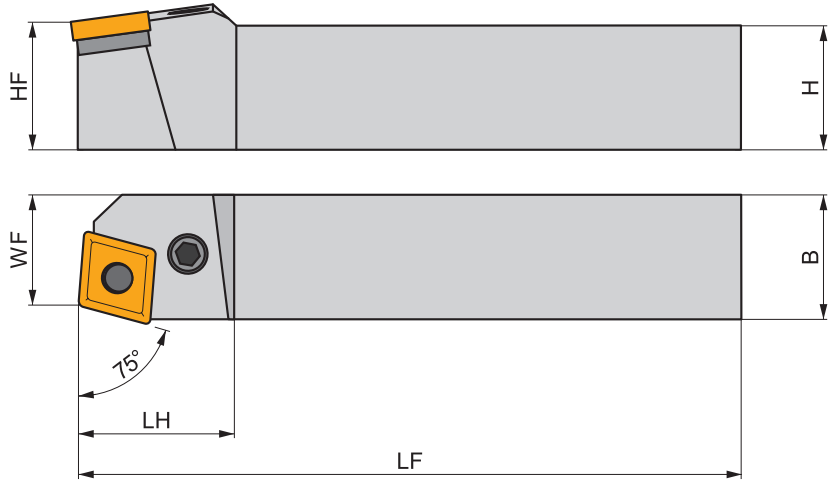
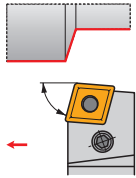

Product	H	B	HF	WF	LF	LH	LAMS	GAMO	kg			
	(mm)	(mm)	(mm)	(mm)	(mm)	(mm)	(°)	(°)				
R	PCBNR 2020 K 12	20	20	20	17	125	28.0	-5	-6	0.40	GI043	PC01
	PCBNR 2525 M 12	25	25	25	22	150	36.0	-6	-6	0.74	GI043	PC01
	PCBNR 3232 P 16	32	32	32	27	170	34.0	-5	-6	1.34	GI050	PC02
	PCBNR 3232 P 19	32	32	32	27	170	42.0	-5	-6	1.10	GI042	PC03
	PCBNR 4040 S 19	40	40	40	35	250	45.0	-6	-6	3.05	GI042	PC03
	PCBNR 4040 S 25	40	40	40	41	250	48.0	-5	-6	3.09	GI062	PC04
	PCBNR 5050 T 25	50	50	50	51	300	50.0	-5	-6	5.80	GI062	PC04
L	PCBNL 2020 K 12	20	20	20	17	125	28.0	-5	-6	0.38	GI043	PC01
	PCBNL 2525 M 12	25	25	25	22	150	28.0	-5	-6	0.73	GI043	PC01
	PCBNL 3232 P 16	32	32	32	27	170	34.0	-5	-6	1.25	GI050	PC02
	PCBNL 3232 P 19	32	32	32	27	170	42.0	-5	-6	1.10	GI042	PC03
	PCBNL 4040 S 19	40	40	40	35	250	48.0	-5	-6	3.10	GI042	PC03
	PCBNL 4040 S 25	40	40	40	41	250	48.0	-5	-6	3.12	GI062	PC04
	PCBNL 5050 T 25	50	50	50	51	300	50.0	-5	-6	5.80	GI062	PC04

GI042	CN.. 1906..
GI043	CN.. 1204..
GI050	CN.. 1606..
GI062	CN.. 2509..

PC01	PCS 612	CL 012	CS 608	3.0	M 8x1	20.7	TR 12	MT 05	HXK 3
PC02	PCS 616	CL 016	CS 618	3.0	M 8x1	22.5	TR 15	MT 07	HXK 3
PC03	PCS 619	CL 019	CS 610	3.5	M 10x1	27.2	TR 19	MT 06	HXK 4
PC04	PCS 625	CL 025	CS 612	4.0	M 12x1	36	TR 25	MT 08	HXK 5

PCKN(RL) EXT



PRAMET



External Lever Lock Holder, 75° (Face Turning) Cutting Angle for CN.. Inserts

External Right/Left hand lever lock 75° tool holder. Suited for external chamfering and face turning with shoulder using negative CN.. inserts. Body treated for longer tool life.

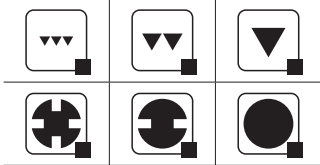
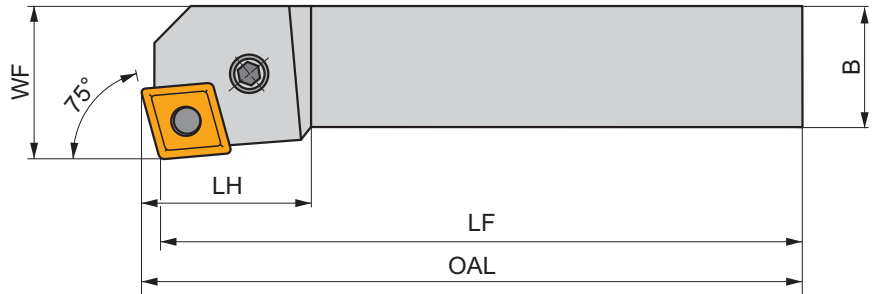
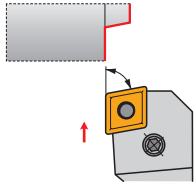

Product	H	B	HF	WF	LF	LH	LAMS	GAMO	kg		
	(mm)	(mm)	(mm)	(mm)	(mm)	(mm)	(°)	(°)			
R PCKNR 2020 K 12	20	20	20	25	125	28.0	-6	-5	0.42	G1043	PC01
PCKNR 2525 M 12	25	25	25	32	150	28.0	-6	-5	0.76	G1043	PC01
PCKNR 3232 P 16	32	32	32	40	170	34.0	-6	-5	1.42	G1050	PC02
PCKNR 3232 P 19	32	32	32	40	170	34.0	-6	-5	1.40	G1042	PC03
PCKNR 4040 S 19	40	40	40	50	250	45.0	-6	-5	3.25	G1042	PC03
L PCKNL 2020 K 12	20	20	20	25	125	28.0	-6	-5	0.42	G1043	PC01
PCKNL 2525 M 12	25	25	25	32	150	28.0	-6	-5	0.77	G1043	PC01
PCKNL 3232 P 16	32	32	32	40	170	34.0	-6	-5	1.40	G1050	PC02
PCKNL 3232 P 19	32	32	32	40	170	45.0	-6	-6	1.40	G1042	PC03
PCKNL 4040 S 19	40	40	40	50	250	45.0	-6	-5	3.27	G1042	PC03

G1042	CN.. 1906..
G1043	CN.. 1204..
G1050	CN.. 1606..

PC01	PCS 612	CL 012	CS 608	3.0	M 8x1	20.7	TR 12	MT 05	HXK 3
PC02	PCS 616	CL 016	CS 618	3.0	M 8x1	22.5	TR 15	MT 07	HXK 3
PC03	PCS 619	CL 019	CS 610	3.5	M 10x1	27.2	TR 19	MT 06	HXK 4

C.-DCLN(RL) EXT



PRAMET

D



Ext. PSC Quick Change Tool, Double Clamp, 95° Cutting Angle for CN.. Inserts

External Right/Left hand double clamp tool, through coolant, with 95° cutting angle for longitudinal turning, chamfering and face turning with shoulder, using negative CN.. inserts. Polygon Shank Coupling. Body treated for longer tool life.

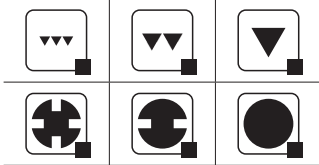
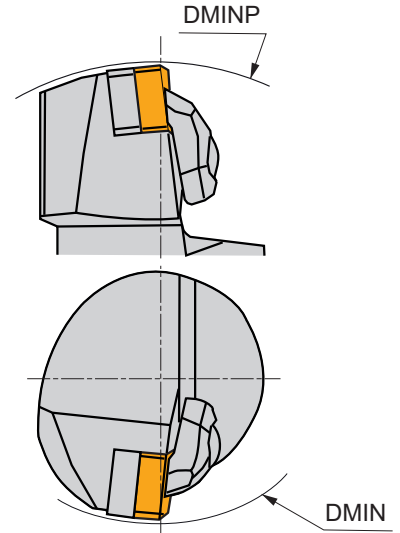
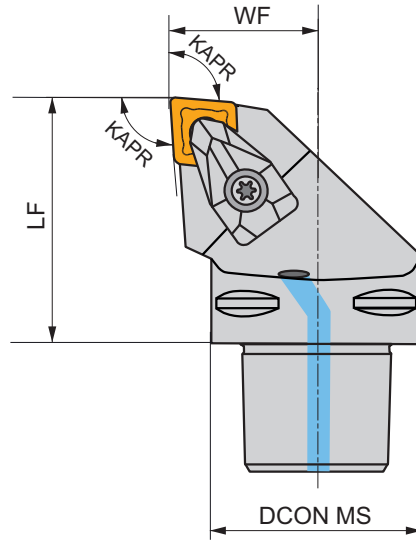
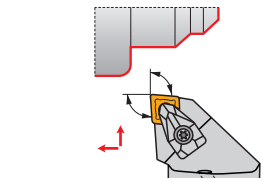













Product	DCON MS	DMIN	DMINP	WF	LF	KAPR	LAMS	GAMO						
	(mm)	(mm)	(mm)	(mm)	(mm)	(°)	(°)	(°)						
R	C3-DCLNR-22045-12	32	60	121	22	45	95	-6	-6	✓	0.25	GI043	C-DC12	AT001
	C4-DCLNR-27050-12	40	110	140	27	50	95	-6	-6	✓	0.44	GI043	C-DC12	AT001
	C4-DCLNR-27055-16	40	125	145	27	55	95	-6	-6	✓	0.47	GI050	C-DC16	AT005
	C5-DCLNR-35060-12	50	110	165	35	60	95	-6	-6	✓	0.79	GI043	C-DC12	AT001
	C5-DCLNR-35060-16	50	125	165	35	60	95	-6	-6	✓	0.80	GI050	C-DC16	AT005
	C6-DCLNR-45065-12	63	110	190	45	65	95	-6	-6	✓	1.32	GI043	C-DC12	AT001
	C6-DCLNR-45065-16	63	125	190	45	65	95	-6	-6	✓	1.34	GI050	C-DC16	AT005
	C6-DCLNR-45065-19	63	81	190	45	65	95	-6	-6	✓	1.34	GI042	C-DC19	-
L	C4-DCLNL-27050-12	40	110	140	27	50	95	-6	-6	✓	0.44	GI043	C-DC12	AT001
	C4-DCLNL-27055-16	40	125	145	27	55	95	-6	-6	✓	0.47	GI050	C-DC16	AT005
	C5-DCLNL-35060-12	50	110	165	35	60	95	-6	-6	✓	0.79	GI043	C-DC12	AT001
	C5-DCLNL-35060-16	50	125	165	35	60	95	-6	-6	✓	0.80	GI050	C-DC16	AT005
	C6-DCLNL-45065-12	63	110	190	45	65	95	-6	-6	✓	1.32	GI043	C-DC12	AT001
	C6-DCLNL-45065-16	63	125	190	45	65	95	-6	-6	✓	1.34	GI050	C-DC16	AT005
	C6-DCLNL-45065-19	63	81	190	45	65	95	-6	-6	✓	1.34	GI042	C-DC19	-
	C8-DCLNL-55080-16	80	125	250	55	80	95	-6	-6	✓	2.58	GI050	C-DC16	AT005
C8-DCLNL-55080-19	80	100	250	55	80	95	-6	-6	✓	2.58	GI042	C-DC19	-	



GI042
GI043
GI050

CN.. 1906..
CN.. 1204..
CN.. 1606..

							
C-DC12	DCS 12	3.9	DCS 234-01	US 2002-T15P	FLAG T15P/3,5	–	CN 045-01
C-DC16	DCS 16	6.4	DCS 234-03	US 2007-T20P	–	LK T20P	CN 045-01
C-DC19	DCS 19	6.4	DCS 236-01	US 2007-T20P	–	LK T20P	CN 045-01

			
AT001a	CN.. 1207..	–	DCS 234-02
AT005a	CN.. 1607..	–	DCS 234-04
AT001b	CER CN.N 1204..	DCS 12C4	–
AT001c	CER CN.A 1204..	DCS 12C2	–
AT005b	CER CN.N 1606..	DCS 16C4	–
AT005c	CER CN.A 1606..	DCS 16C2	–

KHP-CBN(RL)



PRAMET



Modular KHP Lever Lock Turning Cartridge, 75° Cutting Angle for CN.. Inserts

Dovetailed Right/Left hand lever lock turning cartridge, 75° cutting angle, for mounting on DKH tool holder shank. Suited for heavy longitudinal turning without shoulder, face turning, taper and chamfer turning with negative CN.. inserts. Tool holder treated for longer tool life.

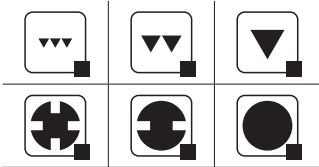
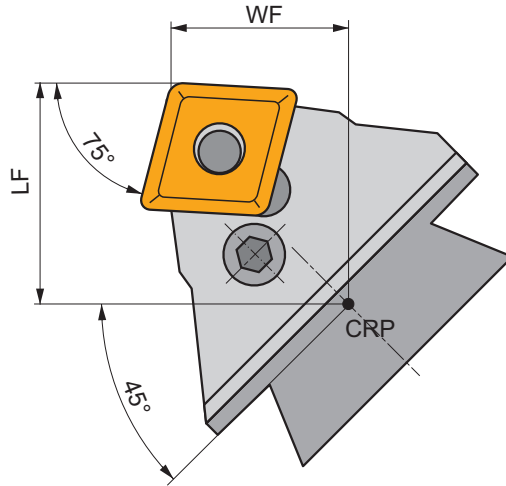
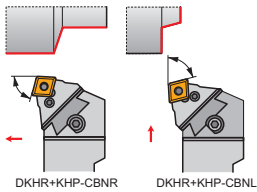

Product	WF (mm)	LF (mm)	LAMS (°)	GAMO (°)	kg		
R KHP-CBNR 25	32	47	-6	-6	1.54	G1062	PC60
L KHP-CBNL 25	32	47	-6	-6	1.56	G1062	PC60

G1062	CN.. 2509..

PC60	CNU 250620	PU 06	US 39	8.0	M 10x1	33	NT 08	MT 08	HXK 5

KHP-CLN(RL)



PRAMET

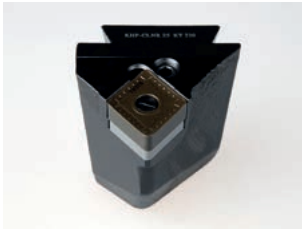

Modular KHP Lever Lock Turning Cartridge, 95° Cutting Angle for CN.. Inserts

Dovetailed Right/Left hand lever lock turning cartridge, 95° cutting angle, for mounting on DKH tool holder shank. Suited for heavy longitudinal turning with shoulder, face turning with shoulder, taper and chamfer turning with negative CN.. insert. Tool holder treated for longer tool life.

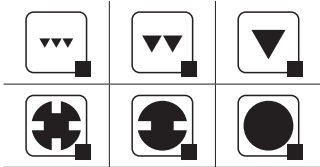
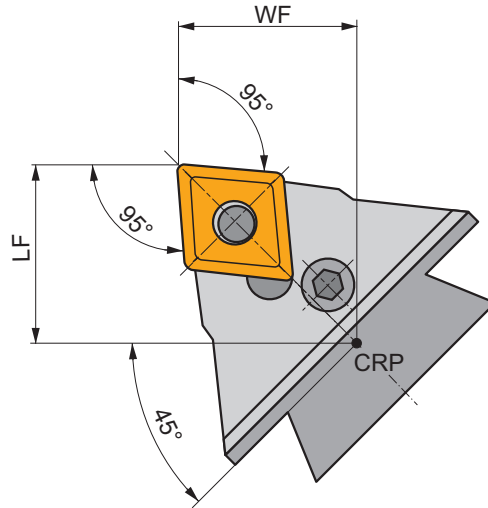
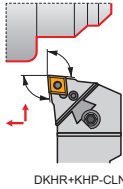

Product	WF (mm)	LF (mm)	LAMS (°)	GAMO (°)	kg		
R KHP-CLNR 19	35	45	-6	-6	1.69	G1042	PC50
KHP-CLNR 25	35	45	-6	-6	1.25	G1062	PC60
L KHP-CLNL 19	35	45	-6	-6	1.30	G1042	PC50
KHP-CLNL 25	35	45	-6	-6	1.25	G1062	PC60

G1042	CN.. 1906..
G1062	CN.. 2509..

PC50	CNU 190416	PU 05	US 38	8.0	M 10x1	29	NT 06	MT 06	HXK 5
PC60	CNU 250620	PU 06	US 39	8.0	M 10x1	33	NT 08	MT 08	HXK 5

DKH(RL)



External Tool Holder Shank for KHP/KHS Heavy Turning Cartridges

Dovetailed Right/Left hand modular tool shank for KHP/KHS cartridges. Suited for heavy turning applications. Body treated for longer tool life.

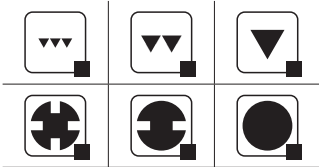
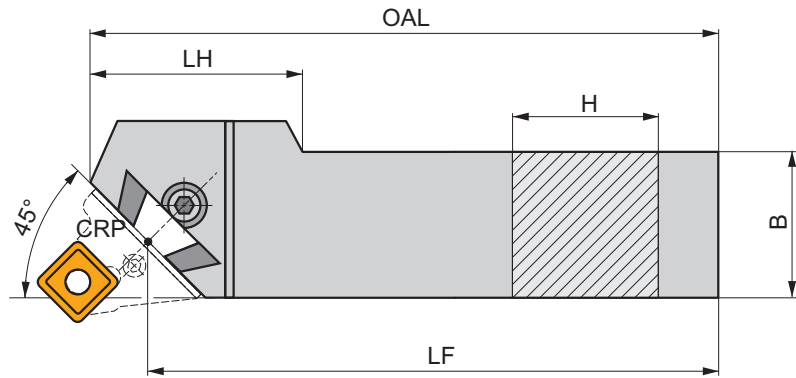
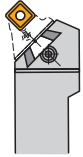

Product	H	B	LF	OAL	LH	kg		
	(mm)	(mm)	(mm)	(mm)	(mm)			
R DKHR 4050 V	40	50	400	425	100.0	7.10	GI098	DKH10
DKHR 5060 W	50	60	450	475	110.0	11.30	GI098	DKH10
DKHR 6080 W-A	60	80	450	485	90.0	19.65	GI098	DKH10
L DKHL 4050 V	40	50	400	425	100.0	7.10	GI098	DKH10
DKHL 5060 W	50	60	450	475	110.0	11.30	GI098	DKH10
DKHL 6080 W-A	60	80	450	485	90.0	19.28	GI098	DKH10

GI098	KHP	KHS

DKH10	SR 14	HXK 10

DCLN(RL) INT

P
M
K
N
S
H

PRAMET

D



Internal Double Clamp Boring Bar with 95° Cutting Angle for CN.. Inserts

Internal Right/Left hand double clamp boring bar, through coolant, 95° cutting angle for CN.. inserts. For internal taper and longitudinal turning with shoulder and chamfer turning. Body treated for longer tool life.

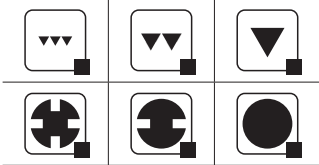
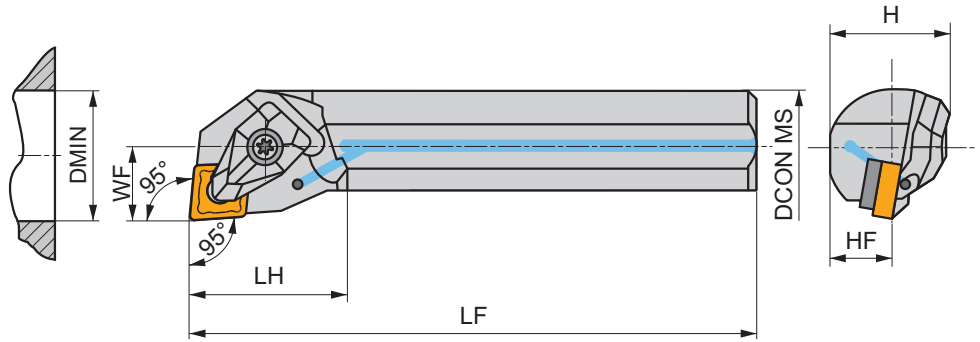
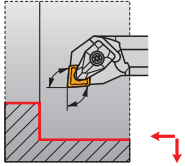

Product	DCON MS	DMIN	WF	H	HF	LF	LH	LAMS	GAMO				
	(mm)	(mm)	(mm)	(mm)	(mm)	(mm)	(mm)	(°)	(°)				
R A25T-DCLNR 09	25	32	17	23	11.5	300	31.0	-11	-6	✓	0.98	G133	DC09
A25T-DCLNR 12	25	32	17	23	11.5	300	31.0	-12	-6	✓	0.98	G1043	DC12
A32T-DCLNR 12	32	40	22	30	15	300	30.0	-10	-6	✓	1.68	G1043	DC12
A40T-DCLNR 12	40	50	27	37	18.5	300	32.0	-15	-6	✓	2.56	G1043	DC12
L A25T-DCLNL 09	25	32	17	23	11.5	300	31.0	-11	-6	✓	0.99	G133	DC09
A25T-DCLNL 12	25	32	17	23	11.5	300	31.0	-12	-6	✓	0.98	G1043	DC12
A32T-DCLNL 12	32	40	22	30	15	300	30.0	-10	-6	✓	1.68	G1043	DC12
A40T-DCLNL 12	40	50	27	37	18.5	300	32.0	-15	-6	✓	2.55	G1043	DC12

G1043		CN.. 1204..	
G1133		CN.. 0903..	

DC09	DCS 09	1.7	DCS 236-04	US 2004-T09P	FLAG T09P
DC12	DCS 12	3.9	DCS 234-01	US 2002-T15P	FLAG T15P/3,5
DC112	DCS 12	3.9	DCS 236-03	US 2002-T15P	FLAG T15P/3,5

PCLN(RL) INT



PRAMET







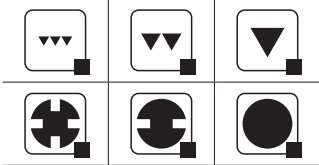
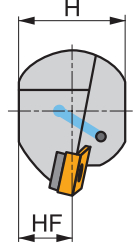
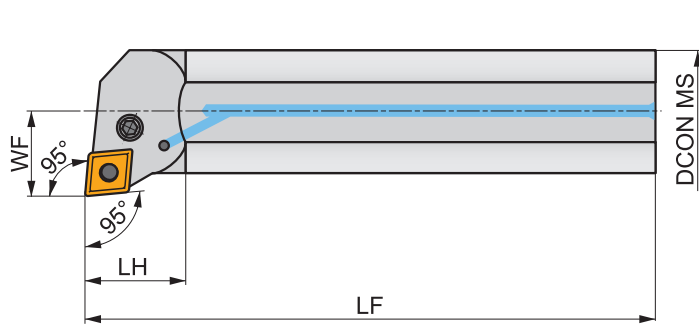
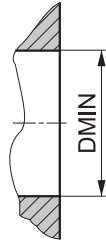
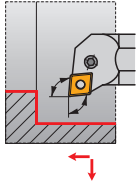





Internal Lever Lock Boring Bar with 95° Cutting Angle for CN.. Inserts

Internal Right/Left hand lever lock boring bar, through coolant available, 95° cutting angle for CN.. inserts. For internal taper and longitudinal turning with shoulder and chamfer turning. Body treated for longer tool life.



Product	DCON MS	DMIN	WF	H	B	LF	LAMS	GAMO					
	(mm)	(mm)	(mm)	(mm)	(mm)	(mm)	(°)	(°)					
R	A16M-PCLNR 09	16	20	11	15	-	150	-14	-4	✓	0.22	G133	PC05
	A20Q-PCLNR 09	20	25	13	18	18	180	-13.5	-5	✓	0.33	G133	PC05
	A25R-PCLNR 12	25	31	17	23	-	200	-14	-4	-	0.70	GI043	PC06
	A32S-PCLNR 12	32	39	22	30	-	250	-12	-4	✓	1.40	GI043	PC07
	A40T-PCLNR 12	40	48	27	37	-	300	-12	-4	✓	2.40	GI043	PC01
	A40T-PCLNR 16	40	48	27	37	-	300	-12	-4	✓	2.65	GI050	PC02
	A50U-PCLNR 16	50	63	35	47	48.5	350	-12	-6	✓	5.20	GI050	PC02
	A60V-PCLNR 16	60	80	43	57	-	400	-12	-4	✓	8.70	GI050	PC02
	A50U-PCLNR 19	50	63	35	47	48.5	350	-12	-6	✓	5.20	GI042	PC08
	A60V-PCLNR 19	60	80	43	57	-	400	-11	-6	✓	8.22	GI042	PC08
L	A16M-PCLNL 09	16	20	11	15	-	150	-14	-4	✓	0.20	G133	PC05
	A20Q-PCLNL 09	20	25	13	18	-	180	-13	-4	-	0.34	G133	PC05
	A25R-PCLNL 12	25	31	17	23	-	200	-14	-4	✓	0.65	GI043	PC06
	A32S-PCLNL 12	32	39	22	30	-	250	-12	-4	✓	1.40	GI043	PC07
	A40T-PCLNL 12	40	50	27	38	38	300	-12	-6	✓	2.58	GI043	PC01
	A40T-PCLNL 16	40	48	27	37	-	300	-12	-4	✓	2.58	GI050	PC02
	A50U-PCLNL 16	50	61	35	47	-	350	-12	-4	✓	4.95	GI050	PC02
	A60V-PCLNL 16	60	80	43	57	-	400	-12	-4	✓	8.70	GI050	PC02

G1042	CN.. 1906..
G1043	CN.. 1204..
GI050	CN.. 1606..
G1133	CN.. 0903..

										
PC01	PCS 612	CL 012	CS 608	3.0	M 8x1	20.7	TR 12	MT 05	HXK 3	
PC02	PCS 616	CL 016	CS 618	3.0	M 8x1	22.5	TR 15	MT 07	HXK 3	
PC05	–	CL 005	CS 605	1.4	M 5x1	12	–	–	HXK 2	
PC07	PCS 612	CL 312	CS 648	3.0	M 8x1	17	TR 12	MT 05	HXK 3	
PC06	–	CL 212	CS 626	2.0	M 6x1	13.4	–	–	HXK 2.5	
PC08	PCS 619	CL 219	CS 610	3.5	M 10x1	27.2	TR 29	MT 06	HXK 4	

C.-DCLN(RL) INT

P
M
K
N
S
H

PRAMET

D



Int. PSC Quick Change Tool, Double Clamp, 95° Cutting Angle for CN.. Inserts

Internal Right/Left hand double clamp tool, through coolant, with 95° cutting angle for negative CN.. inserts. Suited for a wide range of internal turning applications. Polygon Shank Coupling with choice of lengths. Body treated for longer tool life.

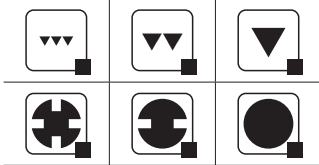
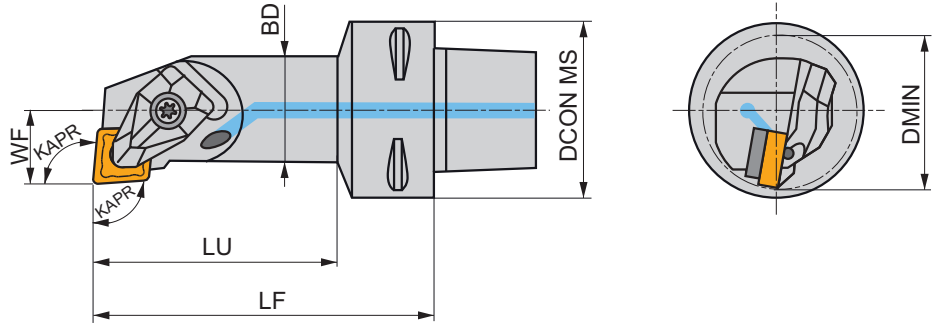
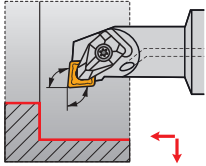

Product	DCON MS	DMIN	WF	LF	LU	BD	KAPR	LAMS	GAMO					
	(mm)	(mm)	(mm)	(mm)	(mm)	(mm)	(°)	(°)	(°)					
R	C4-DCLNR-13080-09	40	25	13	80	57	20	95	-14	-6	✓	0.43	GI133	DC09
	C4-DCLNR-17090-12	40	32	17	90	68	25	95	-12	-6	✓	0.53	GI043	DCI12
	C5-DCLNR-17090-12	50	32	17	90	66	25	95	-12	-6	✓	0.72	GI043	DCI12
	C6-DCLNR-17100-12	63	32	17	100	72	25	95	-12	-6	✓	1.15	GI043	DCI12
	C6-DCLNR-27140-16	63	50	27	140	114	40	95	-16	-6	✓	1.81	GI050	DC16
L	C4-DCLNL-17090-12	40	32	17	90	68	25	95	-12	-6	✓	0.53	GI043	DCI12
	C5-DCLNL-17090-12	50	32	17	90	66	25	95	-12	-6	✓	0.72	GI043	DCI12

GI043		CN.. 1204..
GI050		CN.. 1606..
GI133		CN.. 0903..

DC09	DCS 09	1.7	DCS 236-04	US 2004-T09P	FLAG T09P	-
DC16	DCS 16	6.4	DCS 234-03	US 2007-T20P	-	LKT20P
DCI12	DCS 12	3.9	DCS 236-03	US 2002-T15P	FLAG T15P/3,5	-

DDJN(RL) EXT

P
M
K
N
S
H

PRAMET

D



External Double Clamp Turning Holder with 93° Cutting Angle for DN.. Inserts

External Right/Left hand double clamp tool holder with 93° cutting angle. Suited for longitudinal turning with shoulder, copying, chamfering and facing with negative DN.. Body treated for longer tool life.

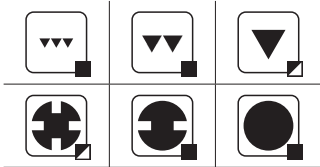
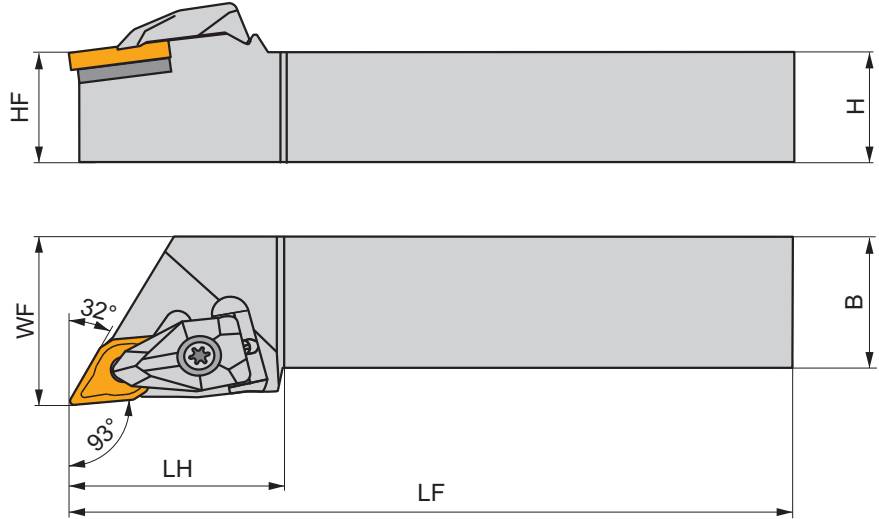
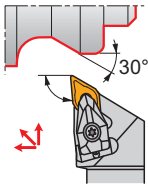

Product	H (mm)	B (mm)	HF (mm)	WF (mm)	LF (mm)	LH (mm)	LAMS (°)	GAMO (°)	kg			
R DDJNR 2020 K 11	20	20	20	25	125	30.2	-7	-6	0.41	GI046	DD11	-
DDJNR 2525 M 11	25	25	25	32	150	30.2	-7	-6	0.74	GI046	DD11	-
DDJNR 2020 K 15	20	20	20	25	125	39.4	-7	-6	0.42	GI044	DD154	AT002
DDJNR 2525 M 15	25	25	25	32	150	39.4	-7	-6	0.74	GI044	DD154	AT002
DDJNR 3225 P 15	32	25	32	32	170	39.4	-7	-6	1.07	GI044	DD154	AT002
DDJNR 3232 P 15	32	32	32	40	170	39.4	-7	-6	1.33	GI044	DD154	AT002
L DDJNL 2020 K 11	20	20	20	25	125	30.2	-7	-6	0.42	GI046	DD11	-
DDJNL 2525 M 11	25	25	25	32	150	30.2	-7	-6	0.74	GI046	DD11	-
DDJNL 2020 K 15	20	20	20	25	125	39.4	-7	-6	0.42	GI044	DD154	AT002
DDJNL 2525 M 15	25	25	25	32	150	39.4	-7	-6	0.74	GI044	DD154	AT002
DDJNL 3225 P 15	32	25	32	32	170	39.4	-7	-6	1.01	GI044	DD154	AT002
DDJNL 3232 P 15	32	32	32	40	170	39.4	-7	-6	1.34	GI044	DD154	AT002

	GI044	DN.. 1506..
	GI046	DN.. 1104..

	DD11		DCS 09		1.7		DDS 267-01		US 2004-T09P		FLAG T09P
	DD154		DCS 12		3.9		DDS 266-02		US 2002-T15P		FLAG T15P/3,5

	AT002a		DN.. 1504..		-		DDS 266-01
	AT002b		CER DN.N 1506..		DCS 12C4		-
	AT002c		CER DN.A 1506..		DCS 12C2		-

PDJN(RL) EXT



PRAMET



External Lever Lock Turning Holder with 93° Cutting Angle for DN.. Inserts

External Right/Left hand lever lock tool holder with 93° cutting angle. Suited for longitudinal turning with shoulder, copy turning up to 30°, and chamfering with negative DN.. inserts. Body treated for longer tool life.

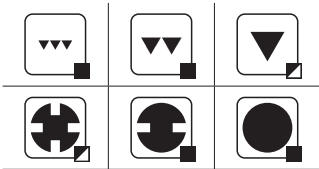
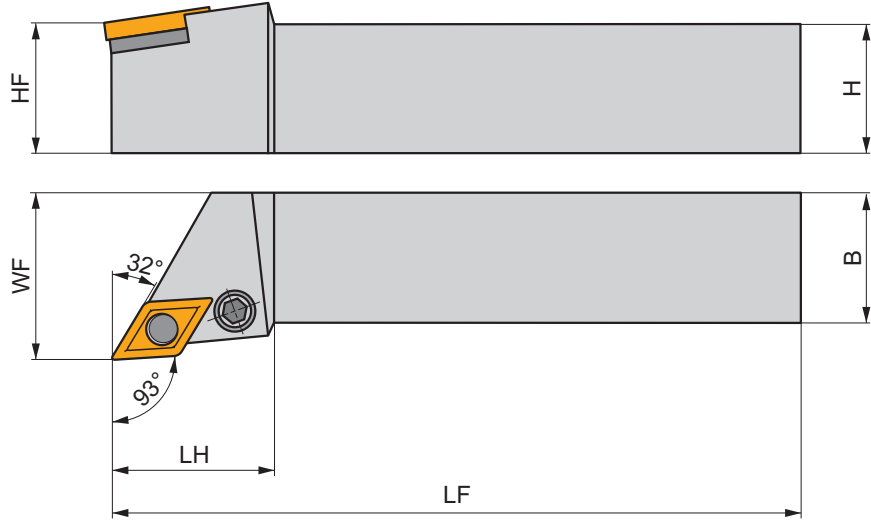
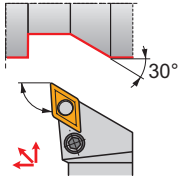

Product	H	B	HF	WF	LF	LH	LAMS	GAMO	kg		
	(mm)	(mm)	(mm)	(mm)	(mm)	(mm)	(°)	(°)			
R PDJNR 2020 K 11	20	20	20	25	125	28.0	-7	-6	0.40	GI046	PD02
PDJNR 2525 M 11	25	25	25	32	150	28.0	-7	-6	0.73	GI046	PD02
PDJNR 2020 K 15	20	20	20	25	125	34.0	-7	-6	0.39	GI044	PD01
PDJNR 2525 M 15	25	25	25	32	150	34.0	-7	-6	0.73	GI044	PD01
PDJNR 3225 P 15	32	25	32	32	170	34.0	-7	-6	1.04	GI044	PD01
PDJNR 3232 P 15	32	32	32	40	170	34.0	-7	-6	1.30	GI044	PD01
L PDJNL 2020 K 11	20	20	20	25	125	28.0	-7	-6	0.40	GI046	PD02
PDJNL 2525 M 11	25	25	25	32	150	28.0	-7	-6	0.73	GI046	PD02
PDJNL 2020 K 15	20	20	20	25	125	40.0	-6	-6	0.42	GI044	PD01
PDJNL 2525 M 15	25	25	25	32	150	34.0	-7	-6	0.73	GI044	PD01
PDJNL 3225 P 15	32	25	32	32	170	34.0	-7	-6	0.98	GI044	PD01
PDJNL 3232 P 15	32	32	32	40	170	34.0	-7	-6	1.30	GI044	PD01

G1044		DN.. 1506..
G1046		DN.. 1104..

PD01	PDS 715	CL 415	CS 638	3.0	M 8x1	21.1	TR 12	MT 05	HXK 3
PD02	PDS 711	CL 009	CS 606	2.0	M 6x1	16.7	TR 09	MT 04	HXK 2.5

PDNN(RL) EXT



PRAMET

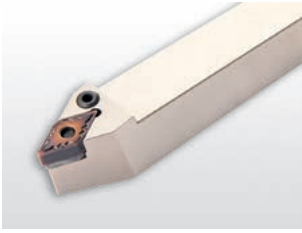

External Lever Lock Turning Holder with 63° Cutting Angle for DN.. Inserts

External Right/Left hand lever lock 63° (neutral) tool holder. Suited for longitudinal turning without shoulder, taper, copy, and chamfer turning with negative DN.. inserts. Body treated for longer tool life.

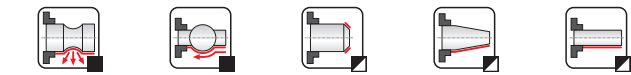
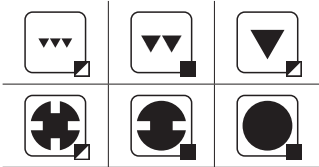
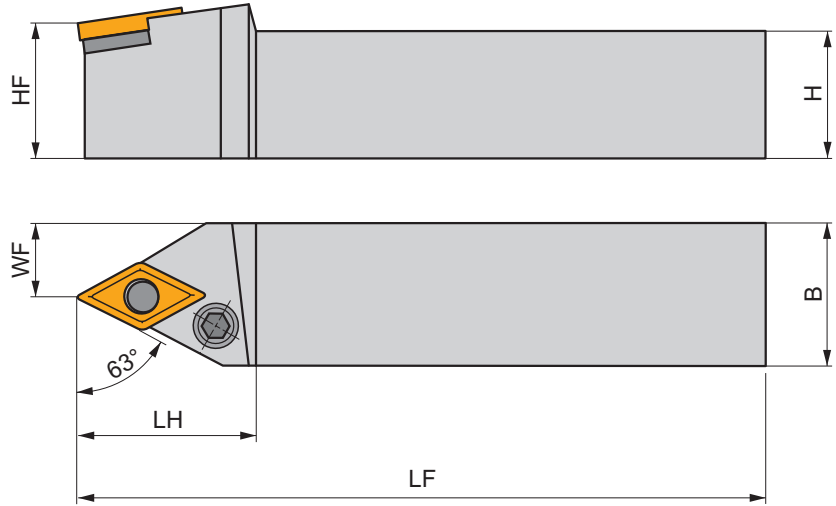
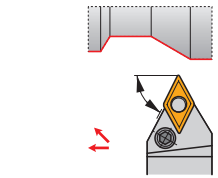

Product	H (mm)	B (mm)	HF (mm)	WF (mm)	LF (mm)	LH (mm)	LAMS (°)	GAMO (°)	kg	GI044	GI046	PD01	PD02
R PDNNR 2020 K 11	20	20	20	10	125	28.0	-6	-6	0.37	GI046			PD02
PDNNR 2525 M 11	25	25	25	12.5	150	25.0	-6	-6	0.60	GI046			PD02
PDNNR 2525 M 15	25	25	25	12.5	150	34.0	-6	-6	0.69	GI044			PD01
PDNNR 3225 P 15	32	25	32	12.5	170	34.0	-6	-6	1.00	GI044			PD01
L PDNNL 2020 K 11	20	20	20	10	125	28.0	-6	-6	0.40	GI046			PD02
PDNNL 2525 M 11	25	25	25	12.5	150	25.0	-6	-6	0.60	GI046			PD02
PDNNL 2525 M 15	25	25	25	12.5	150	34.0	-6	-6	0.07	GI044			PD01
PDNNL 3225 P 15	32	25	32	12.5	170	34.0	-6	-6	1.00	GI044			PD01

GI044	GI046	DN.. 1506..	DN.. 1104..

PD01	PD02	PDS 715	PDS 711	CL 415	CL 009	CS 638	CS 606	3.0	2.0	M 8x1	M 6x1	21.1	16.7	TR 12	TR 09	MT 05	MT 04	HXK 3	HXK 2.5	

PDXN(RL) EXT



PRAMET



External Lever Lock Turning Holder with 98° Cutting Angle for DN.. Inserts

External Right/Left hand lever lock tool holder with 98° cutting angle. Suited for taper, longitudinal turning with shoulder, copy turning up to 22° and chamfering with negative DN.. inserts. Body treated for longer tool life.

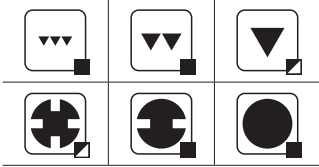
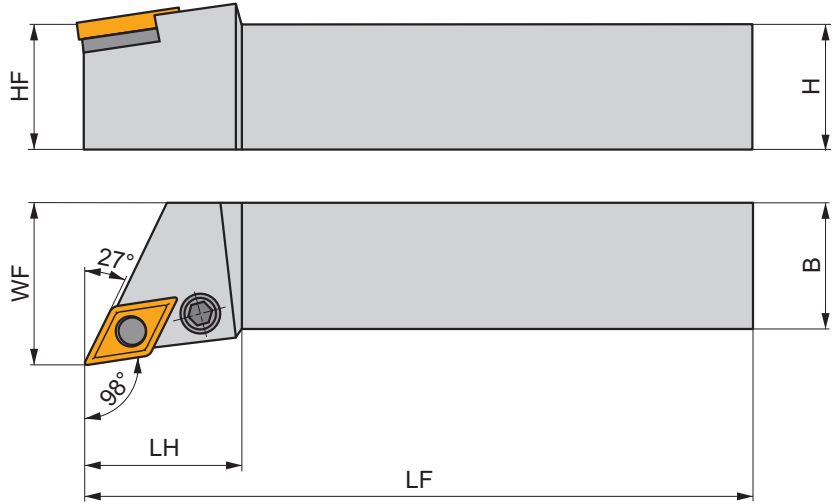
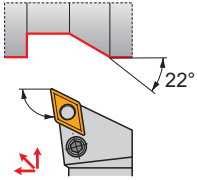

Product	H	B	HF	WF	LF	LH	LAMS	GAMO	kg		
	(mm)	(mm)	(mm)	(mm)	(mm)	(mm)	(°)	(°)			
R PDXNR 2020 K 15	20	20	20	25	125	40.0	-6	-6	0.38	GI044	PD01
PDXNR 2525 M 15	25	25	25	32	150	40.0	-6	-6	0.73	GI044	PD01
PDXNR 3225 P 15	32	25	32	32	170	34.0	-8	-3	0.80	GI044	PD01
L PDXNL 2020 K 15	20	20	20	25	125	34.0	-8	-3	0.40	GI044	PD01
PDXNL 2525 M 15	25	25	25	32	150	34.0	-8	-3	0.71	GI044	PD01
PDXNL 3225 P 15	32	25	32	32	170	34.0	-8	-3	0.95	GI044	PD01

GI044 DN.. 1506..

C-DDJN(RL) EXT

P
M
K
N
S
H

PRAMET

D



Ext. PSC Quick Change Tool, Double Clamp, 93° Cutting Angle for DN.. Inserts

External Right/Left hand double clamp tool, through coolant, with 93° cutting angle for taper and longitudinal turning with shoulder, copying and chamfering with negative DN.. inserts. Polygon Shank Coupling. Body treated for longer tool life.

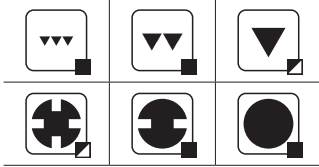
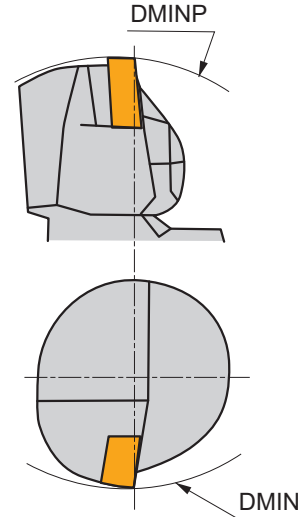
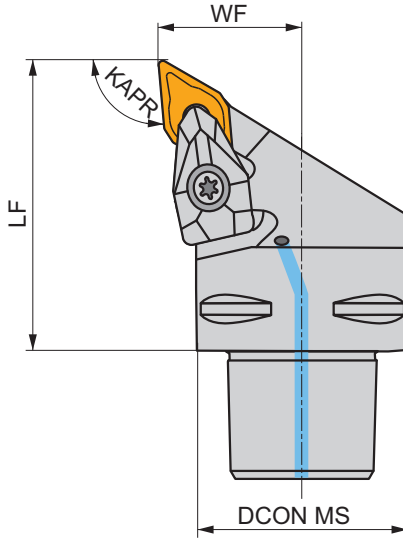
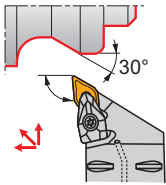

Product	DCON MS	DMIN	DMINP	WF	LF	KAPR	LAMS	GAMO					
	(mm)	(mm)	(mm)	(mm)	(mm)	(°)	(°)	(°)					
R C4-DDJNR-27050-11	40	60	140	27	50	93	-7	-6	✓	0.38	GI046	C-DD11	-
C4-DDJNR-27055-15	40	110	145	27	55	93	-7	-6	✓	0.43	GI044	C-DD154-1	AT002
C5-DDJNR-35060-15	50	110	165	35	60	93	-7	-6	✓	0.72	GI044	C-DD154-2	AT002
C6-DDJNR-45065-15	63	110	190	45	65	93	-7	-6	✓	1.18	GI044	C-DD154-3	AT002
L C4-DDJNL-27050-11	40	60	140	27	50	93	-7	-6	✓	0.39	GI046	C-DD11	-
C4-DDJNL-27055-15	40	110	145	27	55	93	-7	-6	✓	0.43	GI044	C-DD154-1	AT002
C5-DDJNL-35060-15	50	110	165	35	60	93	-7	-6	✓	0.72	GI044	C-DD154-2	AT002
C6-DDJNL-45065-15	63	110	190	45	65	93	-7	-6	✓	1.18	GI044	C-DD154-3	AT002

	GI044	DN.. 1506..
	GI046	DN.. 1104..

C-DD11	DCS 09	1.7	DDS 267-01	US 2004-T09P	FLAG T09P	CN 034-01
C-DD154-1	DCS 12	3.9	DDS 266-02	US 2002-T15P	FLAG T15P/3,5	CN 034-01
C-DD154-2	DCS 12	3.9	DDS 266-02	US 2002-T15P	FLAG T15P/3,5	CN 045-01
C-DD154-3	DCS 12	3.9	DDS 266-02	US 2002-T15P	FLAG T15P/3,5	CN 034-02

AT002a	DN.. 1504..	-	DDS 266-01
AT002b	CER DN.N 1506..	DCS 12C4	-
AT002c	CER DN.A 1506..	DCS 12C2	-
AT002d	CER DN.N 1504..	DCS 12C4	DDS 266-01
AT002e	CER DN.A 1504..	DCS 12C2	DDS 266-01

C.-DDNNN EXT

P M K N S H

PRAMET

D



Ext. PSC Quick Change Tool, Double Clamp, 62.5° Cutting Angle for DN.. Inserts

External Right/Left hand double clamp tool, through coolant, with 62.5° cutting angle for taper and longitudinal turning without shoulder, copying and chamfering with negative DN.. inserts. Polygon Shank Coupling. Body treated for longer tool life.

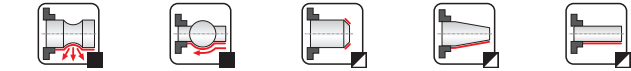
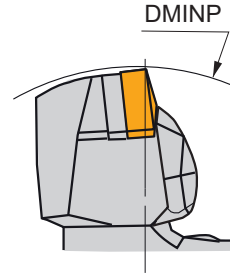
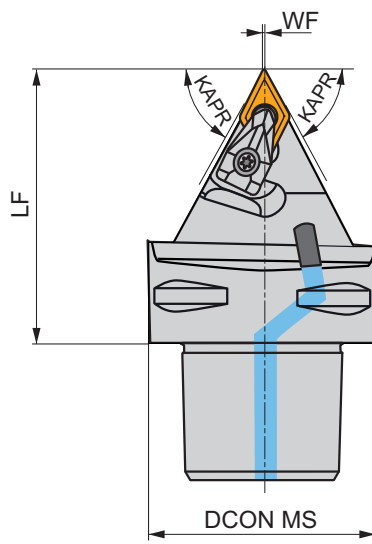
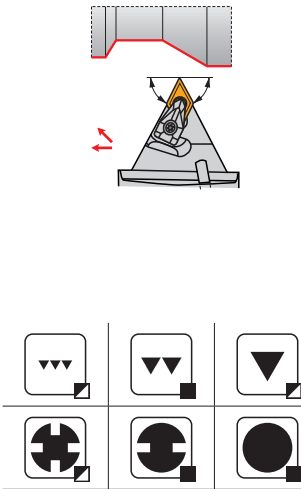

Product	DCON MS (mm)	DMINP (mm)	WF (mm)	LF (mm)	KAPR (°)	LAMS (°)	GAMO (°)		kg			
N C5-DDNNN-00060-15	50	165	0.5	60	62.5	-9	-5	✓	0.62	GI044	C-DD154-2	AT002
C6-DDNNN-00065-15	63	190	0.5	65	62.5	-9	-5	✓	1.06	GI044	C-DD154-2	AT002

	GI044		DN.. 1506..
--	-------	--	-------------

	C-DD154-2		DCS 12		3.9		DDS 266-02		US 2002-T15P		FLAG T15P/3,5		CN 045-01
--	-----------	--	--------	--	-----	--	------------	--	--------------	--	---------------	--	-----------

	AT002a		DN.. 1504..		-		DDS 266-01
AT002b	AT002b	CER DN.N 1506..	CER DN.N 1506..	DCS 12C4	-	-	-
AT002c	AT002c	CER DN.A 1506..	CER DN.A 1506..	DCS 12C2	-	-	-
AT002d	AT002d	CER DN.N 1504..	CER DN.N 1504..	DCS 12C4	-	DDS 266-01	DDS 266-01
AT002e	AT002e	CER DN.A 1504..	CER DN.A 1504..	DCS 12C2	-	DDS 266-01	DDS 266-01

C.-DDUN(RL) EXT

P
M
K
N
S
H

PRAMET

D



Ext. PSC Quick Change Tool, Double Clamp, 93° (Face) Cutting Angle, DN.. Inserts

External Right/Left hand double clamp tool, through coolant, with 93° cutting angle for face turning with shoulder, face copy turning, taper turning, longitudinal turning and chamfering with negative DN.. inserts. Polygon Shank Coupling. Body treated for longer tool life.

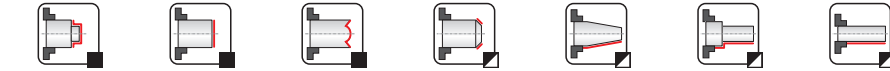
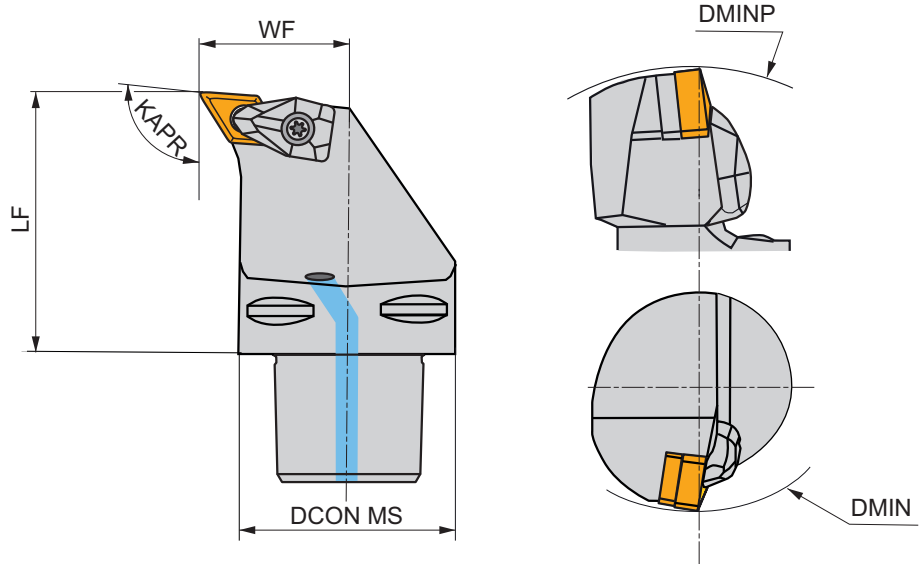
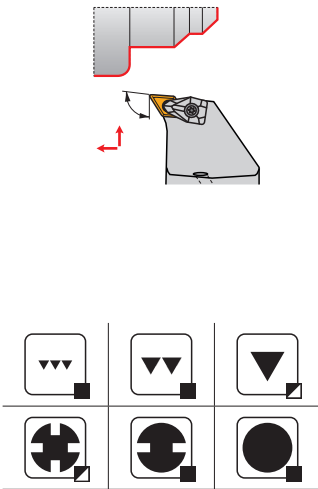

Product	DCON MS	DMIN	DMINP	WF	LF	KAPR	LAMS	GAMO					
	(mm)	(mm)	(mm)	(mm)	(mm)	(°)	(°)	(°)					
R C5-DDUNR-35060-15	50	110	165	35	60	93	-7	-6	✓	0.82	GI044	C-DD154-3	AT002
C6-DDUNR-45065-15	63	110	190	45	65	93	-7	-6	✓	1.39	GI044	C-DD154-3	AT002
L C5-DDUNL-35060-15	50	110	165	35	60	93	-7	-6	✓	0.82	GI044	C-DD154-3	AT002

	GI044		DN.. 1506..
--	-------	--	-------------

	C-DD154-3		DCS 12		3.9		DDS 266-02		US 2002-T15P		FLAG T15P/3,5		CN 034-02
--	-----------	--	--------	--	-----	--	------------	--	--------------	--	---------------	--	-----------

	AT002a		DN.. 1504..		-		DDS 266-01
AT002b	CER DN.N 1506..	DCS 12C4	-				
AT002c	CER DN.A 1506..	DCS 12C2	-				
AT002d	CER DN.N 1504..	DCS 12C4	DDS 266-01				
AT002e	CER DN.A 1504..	DCS 12C2	DDS 266-01				

DDUN(RL) INT

P
M
K
N
S
H

PRAMET

D



Internal Double Clamp Boring Bar with 93° Cutting Angle for DN.. Inserts

Internal Right/Left hand double clamp boring bar, through coolant, 93° cutting angle for DN.. inserts. Suited for wide range of internal turning applications, copy turning up to 27°. Body treated for longer tool life.

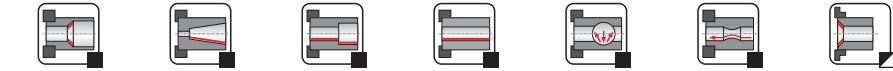
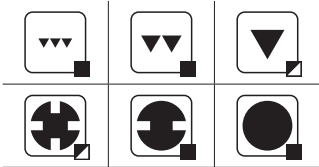
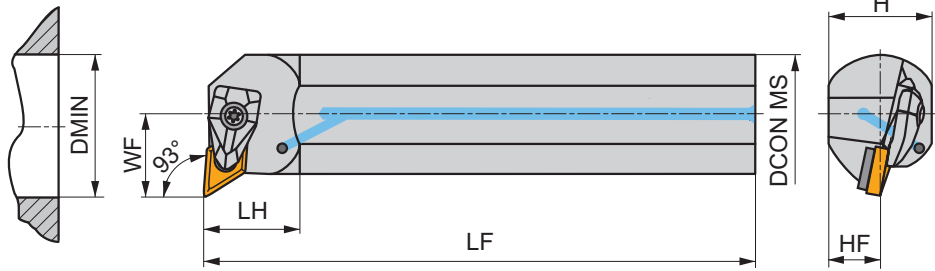
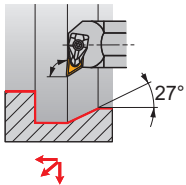

Product	DCON MS	DMIN	WF	H	HF	LF	LH	LAMS	GAMO						
	(mm)	(mm)	(mm)	(mm)	(mm)	(mm)	(°)	(°)							
R	A25T-DDUNR 11	25	32	17	23	11.5	300	28.0	-12	-6	✓	0.96	GI046	DD11	-
	A32T-DDUNR 11	32	40	22	30	15	300	30.0	-10	-6	✓	1.68	GI046	DD11	-
	A40T-DDUNR 15	40	50	27	37	18.5	300	36.0	-11	-6	✓	2.58	GI044	DD154	AT002
	A50U-DDUNR 15	50	63	35	47	23.5	350	39.0	-8	-6	✓	5.23	GI044	DD154	AT002
L	A25T-DDUNL 11	25	32	17	23	11.5	300	28.0	-12	-6	✓	0.96	GI046	DD11	-
	A32T-DDUNL 11	32	40	22	30	15	300	30.0	-10	-6	✓	1.69	GI046	DD11	-
	A40T-DDUNL 15	40	50	27	37	18.5	300	36.0	-11	-6	✓	2.59	GI044	DD154	AT002
	A50U-DDUNL 15	50	63	35	47	23.5	350	39.0	-8	-6	✓	5.25	GI044	DD154	AT002

GI044		DN.. 1506..
GI046		DN.. 1104..

DD11	DCS 09	1.7	DDS 267-01	US 2004-T09P	FLAG T09P
DD154	DCS 12	3.9	DDS 266-02	US 2002-T15P	FLAG T15P/3,5

AT002a	DN.. 1504..	-	DDS 266-01
AT002b	CER DN.N 1506..	DCS 12C4	-
AT002c	CER DN.A 1506..	DCS 12C2	-

PDUN(RL) INT

P M K N S H

PRAMET

P

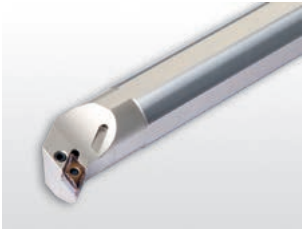

Internal Lever Lock Boring Bar with 93° Cutting Angle for DN.. Insert

Internal Right/Left hand lever lock boring bar, through coolant available, 93° cutting angle for DN.. inserts. For a wide range of internal turning applications, copy turning up to 27°. Body treated for longer tool life.

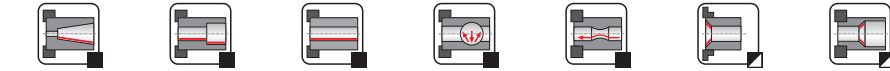
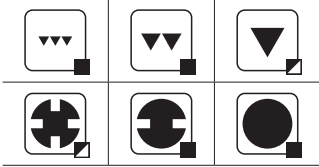
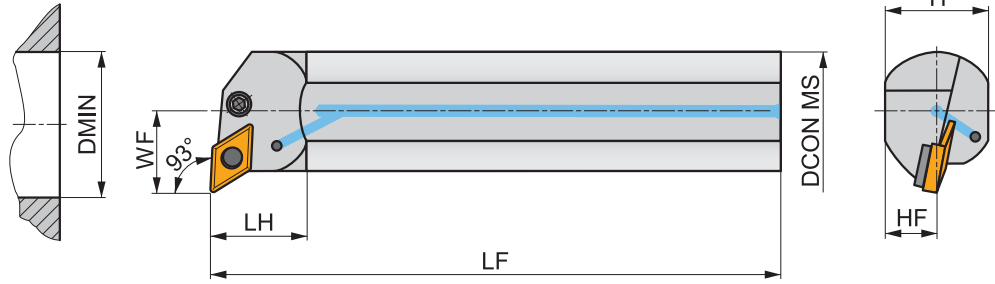
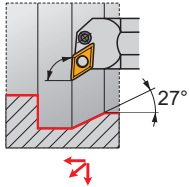

Product	DCON MS	DMIN	WF	H	B	LF	LAMS	GAMO					
	(mm)	(mm)	(mm)	(mm)	(mm)	(mm)	(°)	(°)					
R	A25R-PDUNR 11	25	31	17	23	-	200	-14	-5	✓	0.70	GI046	PD02
	A32S-PDUNR 11	32	39	22	30	-	250	-14	-5	✓	1.42	GI046	PD02
	A32S-PDUNR 15	32	39	22	30	-	250	-14	-4	✓	1.44	GI097	PD04
	A40T-PDUNR 15	40	48	27	37	-	300	-11	-6	✓	2.40	GI097	PD03
	A50U-PDUNR 15	50	61	35	47	-	350	-14	-4	✓	4.95	GI097	PD03
	A60V-PDUNR 15	60	80	43	57	-	400	-14	-4	✓	8.22	GI097	PD03
L	A25R-PDUNL 11	25	31	17	23	-	200	-14	-5	✓	0.70	GI046	PD02
	A32S-PDUNL 11	32	39	22	30	-	250	-14	-5	✓	1.42	GI046	PD02
	A32S-PDUNL 15	32	39	22	30	-	250	-14	-4	✓	1.44	GI097	PD04
	A40T-PDUNL 15	40	48	27	37	-	300	-11	-6	✓	2.56	GI097	PD03
	A60V-PDUNL 15	60	80	43	57	-	400	-14	-4	✓	8.16	GI097	PD03

	GI044	DN.. 1506..
	GI046	DN.. 1104..

PD02	PDS 711	CL 009	CS 606	2.0	M 6x1	16.7	TR 09	MT 04	HXK 2.5	-	-
PD03	PDS 715	CL 415	CS 638	3.0	M 8x1	21.1	TR 12	MT 05	HXK 3	PDS 725	TR 35
PD04	PDS 715	CL 415	CS 648	3.0	M 8x1	17	TR 12	MT 05	HXK 3	PDS 725	TR 35

C-DDUN(RL) INT

P
M
K
N
S
H

PRAMET

D



Int. PSC Quick Change Tool, Double Clamp, 93° Cutting Angle for DN.. Insert

Internal Right/Left hand double clamp tool, through coolant, with 93° cutting angle for internal turning applications including copy turning up to 27° with DN.. inserts. Polygon Shank Coupling. Body treated for longer tool life.

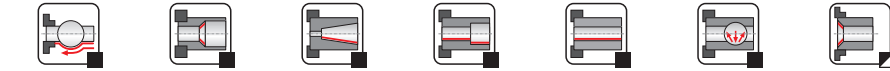
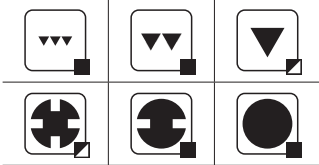
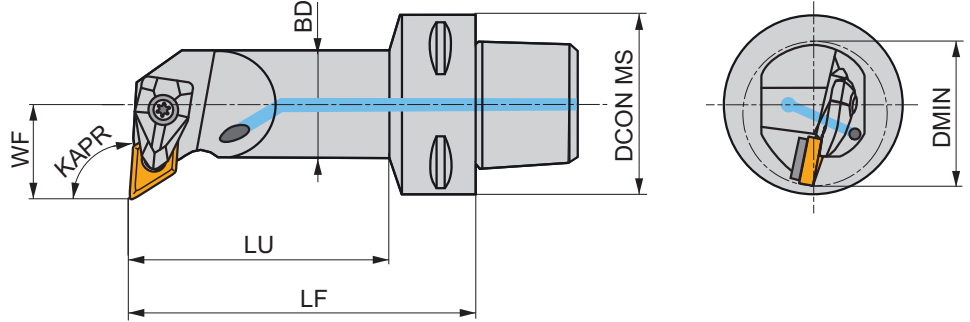
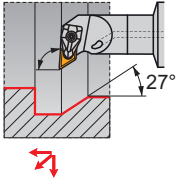

Product	DCON MS (mm)	DMIN (mm)	WF (mm)	LF (mm)	LU (mm)	BD (mm)	KAPR (°)	LAMS (°)	GAMO (°)		kg		
R C4-DDUNR-17090-11	40	32	17	90	68	25	93	-12	-6	✓	0.51	GI046	DD11
L C4-DDUNL-17090-11	40	32	17	90	68	25	93	-12	-6	✓	0.51	GI046	DD11

	GI046		DN.. 1104..
--	-------	--	-------------

	DD11		DCS 09		1.7		DDS 267-01		US 2004-T09P		FLAG T09P
--	------	--	--------	--	-----	--	------------	--	--------------	--	-----------

CKJN(RL) EXT



PRAMET

C



External Top Clamp Turning Holder with 93° Cutting Angle for KN.. Inserts

External Right/Left hand top clamp tool holder with 93° cutting angle. Suited for taper, longitudinal turning with shoulder, copy turning up to 30° and chamfering with negative KN.. inserts. Body treated for longer tool life.

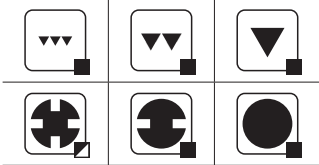
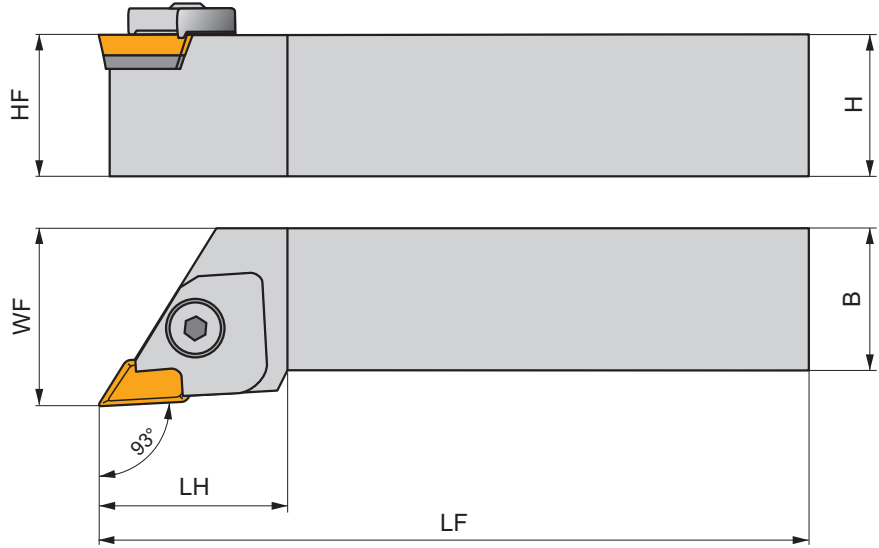
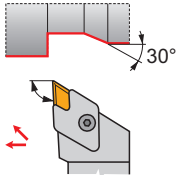

Product	H (mm)	B (mm)	HF (mm)	WF (mm)	LF (mm)	LH (mm)	LAMS (°)	GAMO (°)	kg	GI066	GI067
R CKJNR 2020 K 16	20	20	20	30	125	34.0	1	-5	0.40	GI066	R1
CKJNR 2525 M 16	25	25	25	32	150	34.0	1	-5	0.70	GI066	R
CKJNR 3225 P 16	32	25	32	32	170	34.0	1	-5	1.06	GI066	R
L CKJNL 2020 K 16	20	20	20	30	125	34.0	1	-5	0.42	GI067	L1
CKJNL 2525 M 16	25	25	25	32	150	34.0	1	-5	0.74	GI067	L
CKJNL 3225 P 16	32	25	32	32	170	34.0	1	-5	1.06	GI067	L

GI066	GI067

L	L1	R1	KNN 190412L	NT 03	UP 03	UP 26	US 83	6.0	–	–	PR 07	K 23	HXK 4

PLBN(RL) EXT



PRAMET



External Lever Lock Heavy Turning Holder, 75° Cutting Angle for LNUX Inserts

External Right/Left hand lever lock tool holder with 75° cutting angle for heavy turning. Suited for longitudinal turning without shoulder, taper and chamfer turning with negative LN.. inserts. Body treated for longer tool life.

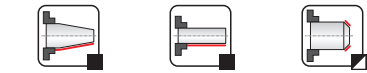
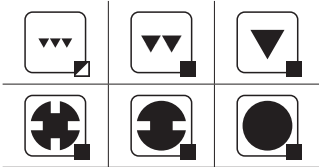
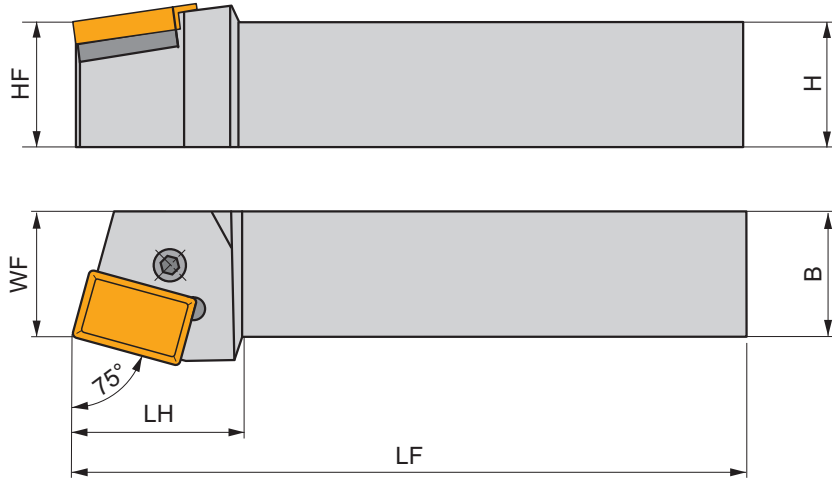
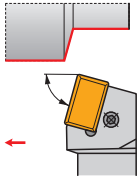

Product	H	B	HF	WF	LF	LH	LAMS	GAMO	kg		
	(mm)	(mm)	(mm)	(mm)	(mm)	(mm)	(°)	(°)			
R PLBNR 6060 V 40-A	60	60	60	60	400	64.0	-6	-6	13.00	G102	PL71
PLBNR 6060 V 50	60	60	60	60	400	70.0	-6	-6	12.75	G145	PL72
PLBNR 6060 V 50-2	60	60	60	60	400	70.0	-6	-6	11.60	G1291	PL73
L PLBNL 6060 V 40-A	60	60	60	60	400	64.0	-6	-6	11.14	G102	PL71
PLBNL 6060 V 50	60	60	60	60	400	70.0	-6	-6	13.09	G145	PL72

G102		LNUX 40....
G145		LNUX 50....
G1291		LNMX 50....

PL71	LNX 400632	PU 06	PS 12040	8.0	M 12x1	40	NT 08	MT 08	HXK 5	-	-
PL72	LNX 500632	PU 06	PS 12040	8.0	M 12x1	40	NT 08	MT 08	HXK 5	-	-
PL73	LNX 500432P	-	-	-	-	-	-	-	-	UP 1515A-T15P	SDRT15P

KHP-LBN(RL)



PRAMET



Modular KHP Lever Lock Turning Cartridge, 75° Cutting Angle for LNUX Inserts

Dovetailed Right/Left hand lever lock turning cartridge, 75° cutting angle, for mounting on DKH tool holder shank. Suited for heavy longitudinal turning without shoulder, taper and chamfer turning with negative LNUX inserts. Tool holder treated for longer tool life.

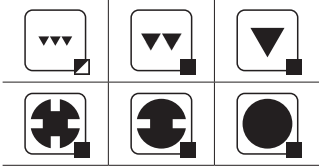
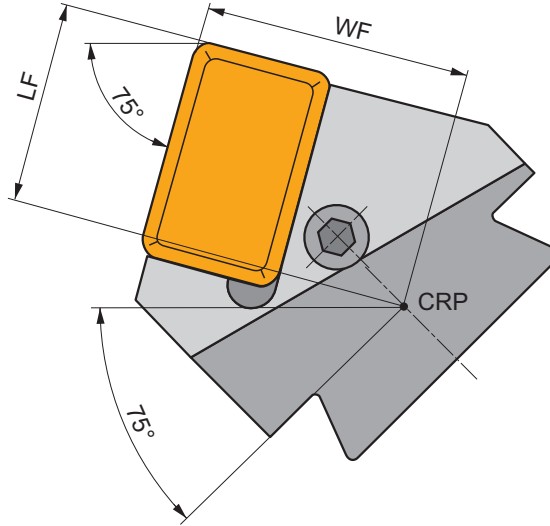
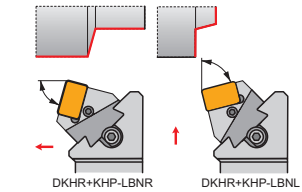

Product	WF (mm)	LF (mm)	LAMS (°)	GAMO (°)	kg		
L KHP-LBNR 40-A	48	36	-6	-6	1.50	G102	PL71
KHP-LBNL 40-A	48	36	-6	-6	1.47	G102	PL71

G102	LNUX 40...

PL71	LNX 400632	PU 06	PS 12040	8.0	M 12x1	40	NT 08	MT 08	HXK 5

DKH(RL)



External Tool Holder Shank for KHP/KHS Heavy Turning Cartridges

Dovetailed Right/Left hand modular tool shank for KHP/KHS cartridges. Suited for heavy turning applications. Body treated for longer tool life.

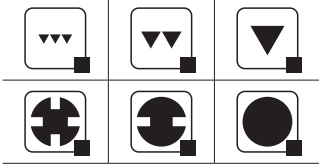
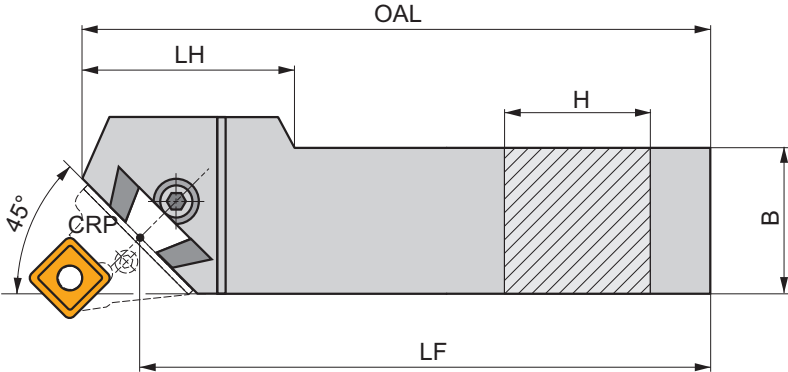
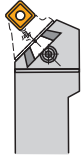

Product	H	B	LF	OAL	LH	kg			
	(mm)	(mm)	(mm)	(mm)	(mm)				
R	DKHR 4050 V	40	50	400	425	100.0	7.10	GI098	DKH10
	DKHR 5060 W	50	60	450	475	110.0	11.30	GI098	DKH10
	DKHR 6080 W-A	60	80	450	485	90.0	19.65	GI098	DKH10
L	DKHL 4050 V	40	50	400	425	100.0	7.10	GI098	DKH10
	DKHL 5060 W	50	60	450	475	110.0	11.30	GI098	DKH10
	DKHL 6080 W-A	60	80	450	485	90.0	19.28	GI098	DKH10

GI098	KHP	KHS

DKH10	SR 14	HXK 10

DRSN(RL) EXT



PRAMET



External Double Clamp Holder for RN.. Inserts

External Right/Left hand double clamp tool holder. Suited for longitudinal turning without shoulder, copy turning, taper and chamfer turning with negative round RN.. inserts. Body treated for longer tool life.

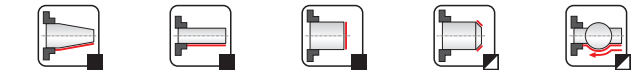
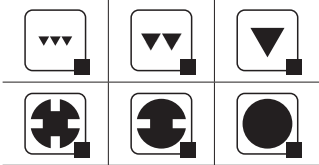
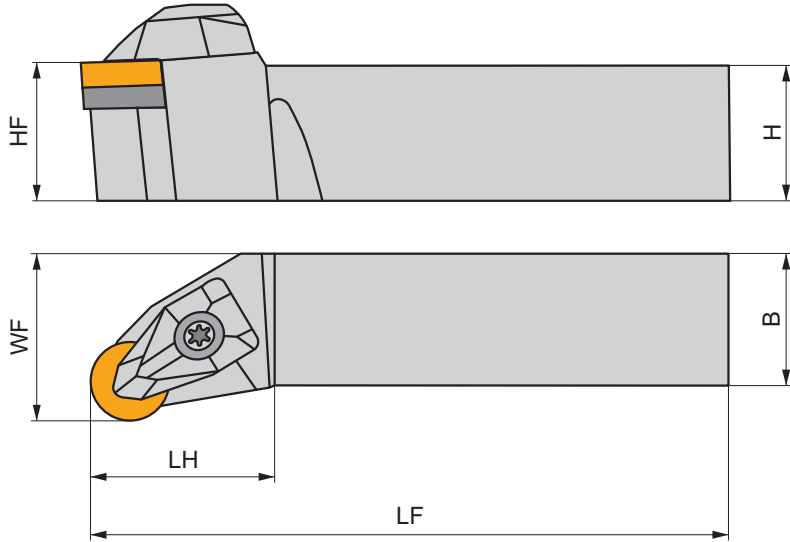
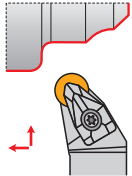

Product	H (mm)	B (mm)	HF (mm)	WF (mm)	LF (mm)	LH (mm)	LAMS (°)	GAMO (°)	kg		
R DRSNR 2525 M 12	25	25	25	32	150	31.6	-6	-6	0.74	GI083	DR12
L DRSNL 2525 M 12	25	25	25	32	150	31.6	-6	-6	0.75	GI083	DR12

GI083	RN.. 120400

DR12	DCS 12	3.9	DRS 155-02	US 2002-T15P	FLAG T15P/3,5

PRSN(RL) EXT



PRAMET



External Lever Lock Holder for RN.. Inserts

External Right/Left hand lever lock tool holder. Suited for longitudinal turning, copy turning up to 90°, taper and chamfer turning with negative round RN.. inserts. Body treated for longer tool life.

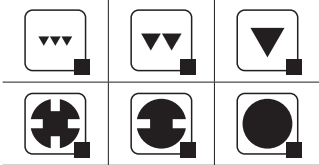
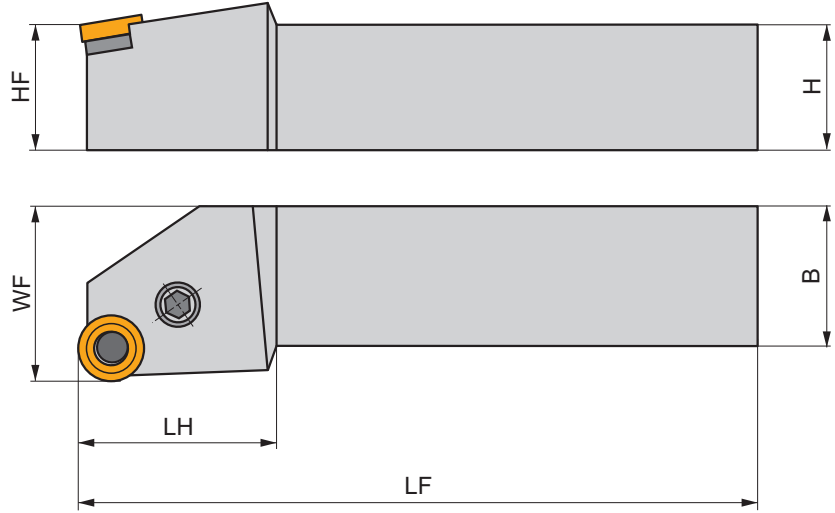
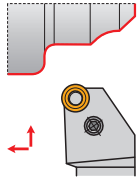

Product	H	B	HF	WF	LF	LH	LAMS	GAMO	kg		
	(mm)	(mm)	(mm)	(mm)	(mm)	(mm)	(°)	(°)			
R PRSNR 2525 M 12	25	25	25	32	150	28.0	-6	-6	0.68	GI083	PR05
PRSNR 3225 P 15	32	25	32	32	170	34.0	-6	-6	1.00	GI105	PR06
PRSNR 4040 S 19	40	40	40	50	250	45.0	-6	-6	2.49	GI106	PR07
L PRSNL 2525 M 12	25	25	25	32	150	28.0	-6	-6	0.74	GI083	PR05
PRSNL 3225 P 15	32	25	32	32	170	34.0	-6	-6	1.00	GI105	PR06
PRSNL 4040 S 19	40	40	40	50	250	45.0	-6	-6	2.49	GI106	PR07

GI083	RN.. 120400
GI105	RN.. 150600
GI106	RN.. 190600

PR05	PRS 912	CL 012	CS 608	3.0	M 8x1	20.7	TR 12	MT 05	HXK 3
PR06	PRS 915	CL 015	CS 708	3.0	M 8x1	23.5	TR 15	MT 07	HXK 3
PR07	PRS 919	CL 019	CS 610	3.5	M 10x1	27.2	TR 19	MT 06	HXK 4

C.-DRSN(RL) EXT



PRAMET

D



External PSC Quick Change Tool, Double Clamp for RN.. Inserts

External Right/Left hand double clamp tool, through coolant, for longitudinal turning without shoulder, copy turning, taper and chamfer turning with negative round RN.. inserts. Polygon Shank Coupling. Body treated for longer tool life.

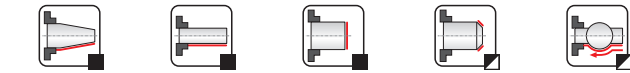
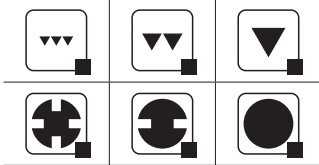
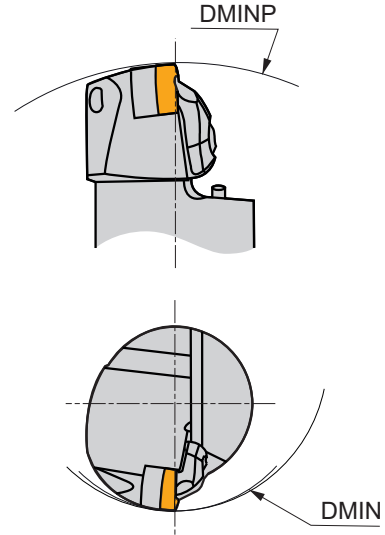
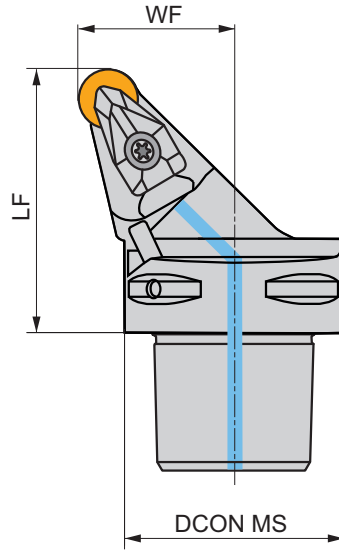
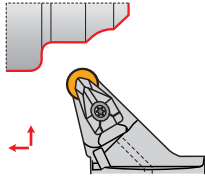

Product	DCON MS (mm)	DMIN (mm)	DMINP (mm)	WF (mm)	LF (mm)	LAMS (°)	GAMO (°)		kg			
R C6-DRSNR-45065-12	63	110	190	45	65	-6	-6	✓	1.11	GI083	C-DR12	-
L C6-DRSNL-45065-12	63	110	190	45	65	-6	-6	✓	1.10	GI083	C-DR12	-

	GI083		RN.. 120400
--	-------	--	-------------

	C-DR12		DCS 12		3.9		DRS 155-02		US 2002-T15P		FLAG T15P/3,5		CN 045-01
--	--------	--	--------	--	-----	--	------------	--	--------------	--	---------------	--	-----------

DSBN(RL) EXT



PRAMET



External Double Clamp Holder with 75° Cutting Angle for SN.. Inserts

External Right/Left hand double clamp tool holder with 75° cutting angle. Suited for longitudinal turning without shoulder, taper and chamfer turning with negative SN.. inserts. Body treated for longer tool life.

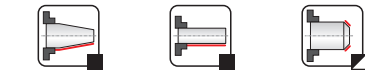
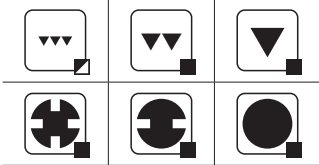
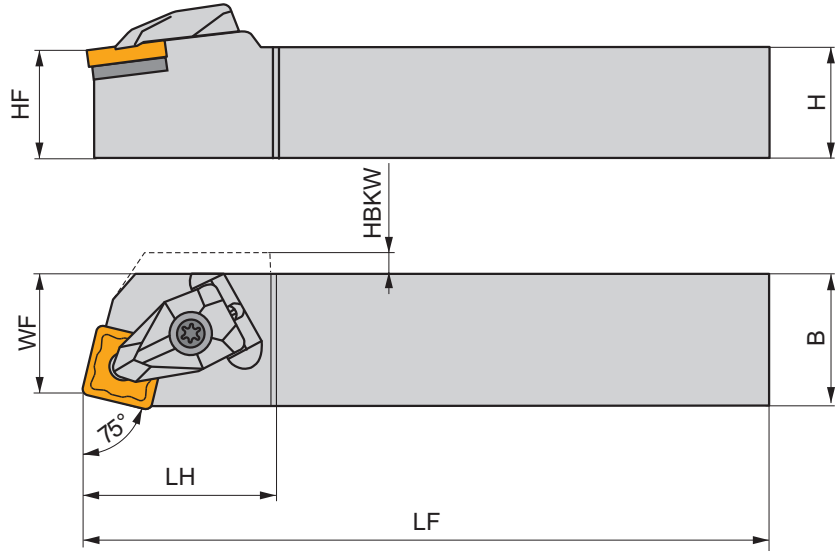
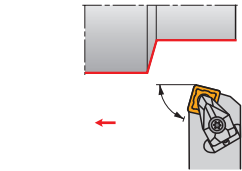

Product	H	B	HF	WF	LF	LH	HBKW	LAMS	GAMO	kg			
	(mm)	(mm)	(mm)	(mm)	(mm)	(mm)	(mm)	(°)	(°)				
R DSBNR 2525 M 12	25	25	25	22	150	34.3	-	-6	-6	0.74	G1029	DS12	AT003
DSBNR 2525 M 15	25	25	25	22	150	41.6	2	-6	-6	0.80	G1082	DS15	AT006
DSBNR 3225 P 15	32	25	32	22	170	41.7	2	-6	-6	1.07	G1082	DS15	AT006
DSBNR 3232 P 19	32	32	32	27	170	46.4	-	-6	-6	1.38	G1026	DS19	-
DSBNR 4040 S 19	40	40	40	35	250	46.5	-	-6	-6	3.14	G1026	DS19	-
L DSBNL 2525 M 12	25	25	25	22	150	34.3	-	-6	-6	0.74	G1029	DS12	AT003
DSBNL 2525 M 15	25	25	25	22	150	41.6	2	-6	-6	0.80	G1082	DS15	AT006
DSBNL 3225 P 15	32	25	32	22	170	41.7	2	-6	-6	1.12	G1082	DS15	AT006
DSBNL 4040 S 19	40	40	40	35	250	46.5	-	-6	-6	3.18	G1026	DS19	-

G1029	SN.. 1204..
G1082	SN.. 1506..
G1026	SN.. 1906..

DS12	DCS 12	3.9	DSS 425-01	US 2002-T15P	FLAG T15P/3,5	-
DS15	DCS 16	6.4	DSS 425-03	US 2007-T20P	-	LKT20P
DS19	DCS 19	6.4	DSS 425-04	US 2007-T20P	-	LKT20P

AT003a	SN.. 1207..	-	DSS 425-02
AT006a	SN.. 1507..	-	DSS 425-05
AT003b	CER SN.N 1204..	DCS 12C4	-
AT003c	CER SN.A 1204..	DCS 12C2	-
AT006b	CER CN.N 1606..	DCS 16C4	-
AT006c	CER CN.A 1606..	DCS 16C2	-

DSDNN EXT

P
M
K
N
S
H

PRAMET

D



External Double Clamp Holder with 45° Cutting Angle for SN.. Inserts

External neutral double clamp tool holder with 45° cutting angle. Suited for longitudinal turning without shoulder, copy, taper and chamfer turning with negative SN.. inserts. Body treated for longer tool life.

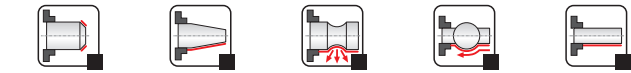
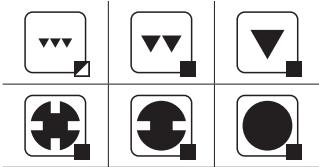
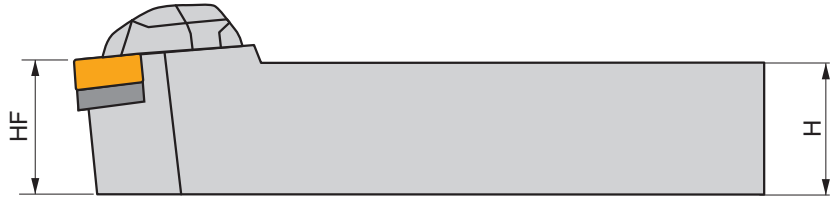
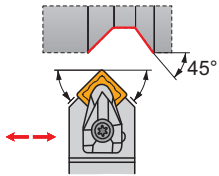

Product	H (mm)	B (mm)	HF (mm)	WF (mm)	LF (mm)	LH (mm)	LAMS (°)	GAMO (°)	kg			
N DSDNN 2525 M 12	25	25	25	12.8	150	36.5	-6	-6	0.74	G1029	DS12	AT003
DSDNN 2525 M 15	25	25	25	12.8	150	44.8	-6	-6	0.76	G1082	DS15	AT006
DSDNN 3232 P 19	32	32	32	16.5	170	49.5	-6	-6	1.35	G1026	DS19	-
DSDNN 4040 S 25	40	40	40	21	250	57.2	-6	-6	3.13	G1027	DS25	-

G1029	SN.. 1204..
G1082	SN.. 1506..
G1026	SN.. 1906..
G1027	SN.. 2507..

DS12	DCS 12	3.9	DSS 425-01	US 2002-T15P	FLAG T15P/3,5	-
DS15	DCS 16	6.4	DSS 425-03	US 2007-T20P	-	LKT20P
DS19	DCS 19	6.4	DSS 425-04	US 2007-T20P	-	LKT20P
DS25	DCS 25	9.5	DSS 425-07	US 2008-T25P	-	LKT25P

AT003a	SN.. 1207..	-	DSS 425-02
AT006a	SN.. 1507..	-	DSS 425-05
AT003b	CER SN.N 1204..	DCS 12C4	-
AT003c	CER SN.A 1204..	DCS 12C2	-
AT006b	CER CN.N 1606..	DCS 16C4	-
AT006c	CER CN.A 1606..	DCS 16C2	-

DSKN(RL) EXT



PRAMET

D



External Double Clamp Holder with 75° (Face) Cutting Angle for SN.. Inserts

External Right/Left hand double clamp tool holder with 75° cutting angle. Suited for facing without shoulder and chamfering with SN.. inserts. Body treated for longer tool life.

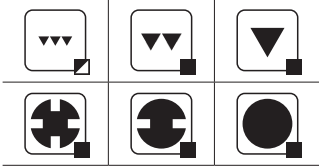
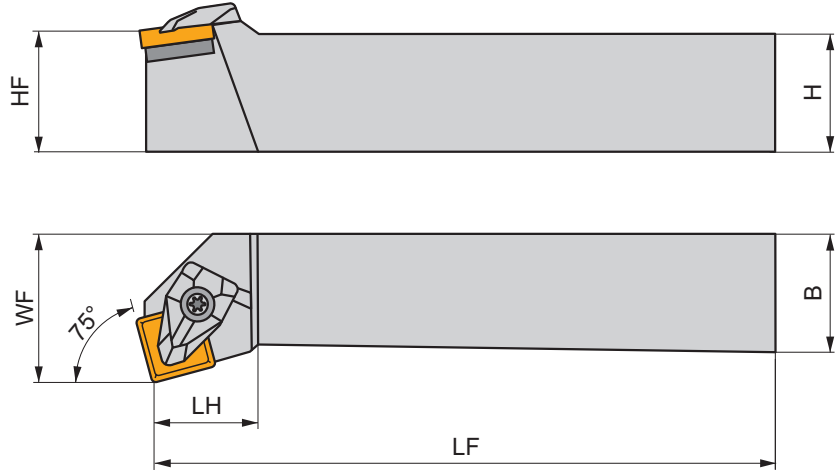
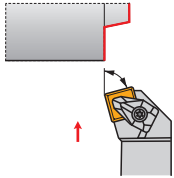

Product	H	B	HF	WF	LF	LH	LAMS	GAMO	kg			
	(mm)	(mm)	(mm)	(mm)	(mm)	(mm)	(°)	(°)				
R DSKNR 2525 M 12	25	25	25	32	150	23.6	-6	-6	0.77	G1029	DS12	AT003
DSKNR 3232 P 19	32	32	32	40	170	32.1	-6	-6	1.46	G1026	DS19	-
L DSKNL 2525 M 12	25	25	25	32	150	23.6	-6	-6	0.79	G1029	DS12	AT003
DSKNL 3232 P 19	32	32	32	40	170	32.1	-6	-6	1.46	G1026	DS19	-

G1029	SN.. 1204..
G1026	SN.. 1906..

DS12	DCS 12	3.9	DSS 425-01	US 2002-T15P	FLAG T15P/3,5	-
DS19	DCS 19	6.4	DSS 425-04	US 2007-T20P	-	LKT20P

AT003a	SN.. 1207..	-	DSS 425-02
AT003b	CER SN.N 1204..	DCS 12C4	-
AT003c	CER SN.A 1204..	DCS 12C2	-

DSSN(RL) EXT



PRAMET



External Double Clamp Holder with 45° Cutting Angle for SN.. Inserts



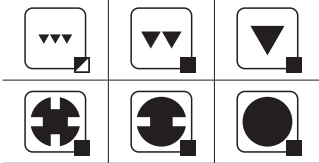
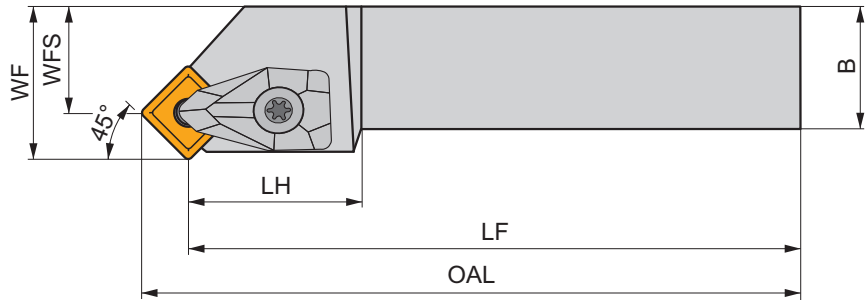
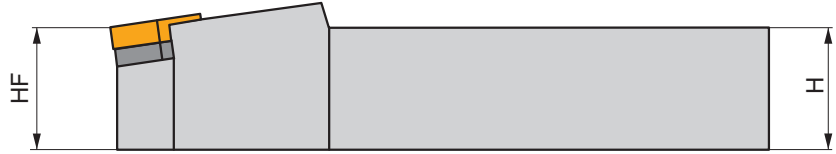
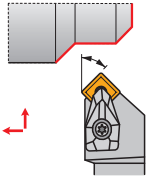

External Right/Left hand double clamp tool holder with 45° cutting angle. Suited for longitudinal and facing without shoulder, taper, copy turning and chamfering with negative SN.. inserts. Body treated for longer tool life.



Product	H	B	HF	WF	WFS	LF	OAL	LH	LAMS	GAMO	kg			
	(mm)	(mm)	(mm)	(mm)	(mm)	(mm)	(mm)	(mm)	(°)	(°)				
R DSSNR 2020 K 12	20	20	20	25	16.7	125	133.3	27.5	0	-8	0.45	G1029	DS12	AT003
DSSNR 2525 M 12	25	25	25	32	23.7	150	158.3	27.5	0	-8	0.80	G1029	DS12	AT003
DSSNR 2525 M 15	25	25	25	32	21.8	150	160.2	32.0	0	-8	0.83	G1082	DS15	AT006
DSSNR 3225 P 15	32	25	32	32	21.8	170	180.2	34.9	0	-8	1.16	G1082	DS15	AT006
DSSNR 3232 P 19	32	32	32	40	27.5	170	182.5	37.0	0	-8	1.48	G1026	DS19	-
L DSSNL 2525 M 12	25	25	25	32	23.7	150	158.3	27.5	0	-8	0.19	G1029	DS12	AT003
DSSNL 2525 M 15	25	25	25	32	21.8	150	160.2	32.0	0	-8	0.83	G1082	DS15	AT006
DSSNL 3225 P 15	32	25	32	32	21.8	170	180.2	34.9	0	-8	1.16	G1082	DS15	AT006
DSSNL 3232 P 19	32	32	32	40	27.5	170	182.5	37.0	0	-8	1.48	G1026	DS19	-
DSSNL 4040 S 19	40	40	40	50	37.5	250	262.5	37.7	0	-8	3.27	G1026	DS19	-

G1029			SN.. 1204..
G1082			SN.. 1506..
G1026			SN.. 1906..

DS12	DCS 12	3.9	DSS 425-01	US 2002-T15P	FLAG T15P/3,5	-
DS15	DCS 16	6.4	DSS 425-03	US 2007-T20P	-	LKT20P
DS19	DCS 19	6.4	DSS 425-04	US 2007-T20P	-	LKT20P

			
AT003a	SN.. 1207..	-	DSS 425-02
AT006a	SN.. 1507..	-	DSS 425-05
AT003b	CER SN.N 1204..	DCS 12C4	-
AT003c	CER SN.A 1204..	DCS 12C2	-
AT006b	CER CN.N 1606..	DCS 16C4	-
AT006c	CER CN.A 1606..	DCS 16C2	-

PSBN(RL) EXT



PRAMET

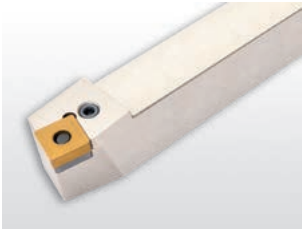

External Lever Lock Holder with 75° Cutting Angle for SN.. Inserts

External Right/Left hand lever lock tool holder with 75° cutting angle. Suited for longitudinal turning without shoulder, taper turning and chamfering with negative SN.. inserts. Body treated for longer tool life.

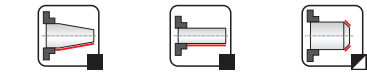
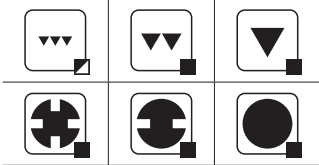
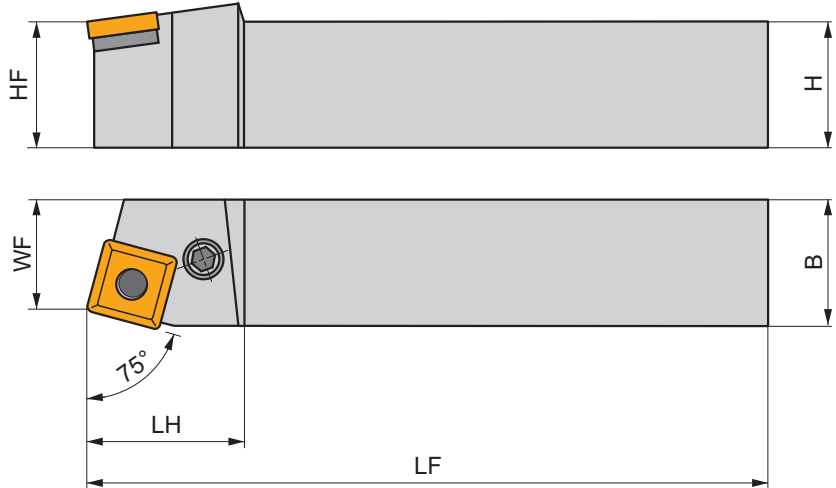
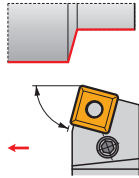









	Product	H	B	HF	WF	LF	LH	LAMS	GAMO	kg		
		(mm)	(mm)	(mm)	(mm)	(mm)	(mm)	(°)	(°)			
R	PSBNR 2020 K 12	20	20	20	17	125	36.0	-6	-6	0.42	GI029	PS01
	PSBNR 2525 M 12	25	25	25	22	150	28.0	-6	-6	0.74	GI029	PS01
	PSBNR 3232 P 15	32	32	32	27	170	34.0	-6	-6	1.33	GI082	PS04
	PSBNR 3232 P 19	32	32	32	27	170	42.0	-6	-6	1.30	GI026	PS02
	PSBNR 4040 S 19	40	40	40	35	250	48.0	-6	-6	3.10	GI026	PS02
	PSBNR 4040 S 25	40	40	40	35	250	48.0	-6	-6	2.85	GI027	PS03
	PSBNR 4040 S 2509	40	40	40	35	250	48.0	-6	-6	2.50	GI040	PS03
	PSBNR 4040 S 2512	40	40	40	35	250	48.0	-6	-6	3.00	GI162	PS05
	PSBNR 5050 T 2512	50	50	50	43	300	50.0	-6	-6	5.78	GI162	PS05
	PSBNR 5050 T 25	50	50	50	43	300	50.0	-6	-6	5.76	GI027	PS03
	PSBNR 5050 T 2509	50	50	50	43	300	50.0	-6	-6	5.50	GI040	PS03
L	PSBNL 2020 K 12	20	20	20	17	125	28.0	-6	-6	0.40	GI029	PS01
	PSBNL 2525 M 12	25	25	25	22	150	28.0	-6	-6	0.73	GI029	PS01
	PSBNL 3232 P 15	32	32	32	27	170	34.0	-6	-6	1.33	GI082	PS04
	PSBNL 4040 S 2512	40	40	40	35	250	48.0	-6	-6	3.11	GI162	PS05
	PSBNL 5050 T 2512	50	50	50	43	300	50.0	-6	-6	5.76	GI162	PS05
	PSBNL 3232 P 19	32	32	32	27	170	42.0	-6	-6	1.33	GI026	PS02
	PSBNL 4040 S 19	40	40	40	35	250	48.0	-6	-6	3.09	GI026	PS02
	PSBNL 4040 S 25	40	40	40	35	250	48.0	-6	-6	3.06	GI027	PS03
	PSBNL 4040 S 2509	40	40	40	35	250	50.0	-6	-6	2.50	GI040	PS03
	PSBNL 5050 T 25	50	50	50	43	300	50.0	-6	-6	5.84	GI027	PS03
	PSBNL 5050 T 2509	50	50	50	43	300	50.0	-6	-6	5.80	GI040	PS03

GI029	SN.. 1204..
GI082	SN.. 1506..



GI026	SN.. 1906..
GI027	SN.. 2507..
GI040	SN.. 2509..
GI162	SN.. 2512..



									
PS01	PSS 512	CL 012	CS 608	3.0	M 8x1	20.7	TR 12	MT 05	HXK 3
PS02	PSS 519	CL 019	CS 610	3.5	M 10x1	27.2	TR 19	MT 06	HXK 4
PS03	PSS 525	CL 025	CS 612	4.0	M 12x1	36	TR 25	MT 08	HXK 5
PS04	PSS 515	CL 016	CS 618	3.0	M 8x1	22.5	TR 15	MT 07	HXK 3
PS05	SNU 250624	PU 10-N	PS 12040	8.0	M 12x1	40	NT 08	MT 08	HXK 5

PSDNN EXT

P
M
K
N
S
H

PRAMET

P



External Lever Lock Holder with 45° Cutting Angle for SN.. Inserts

External neutral lever lock tool holder with 45° cutting angle. Suited for longitudinal turning without shoulder, copy and taper turning and chamfering with negative SN.. inserts. Body treated for longer tool life.

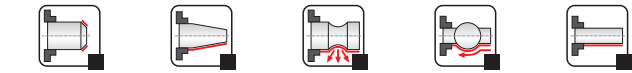
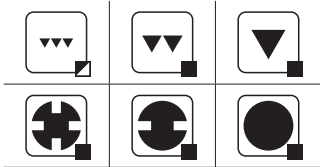
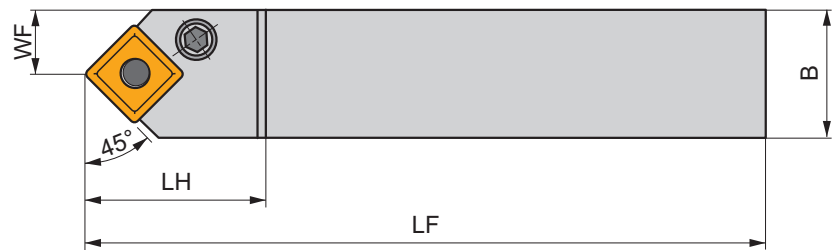
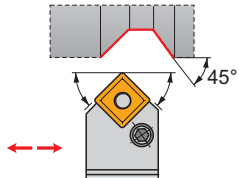

Product	H (mm)	B (mm)	HF (mm)	WF (mm)	LF (mm)	LH (mm)	LAMS (°)	GAMO (°)	kg	GI029	GI082	PS01
N PSDNN 2020 K 12	20	20	20	10	125	28.0	-5	-5	0.39	GI029	PS01	
PSDNN 2525 M 12	25	25	25	12.5	150	28.0	-5	-5	0.68	GI029	PS01	
PSDNN 3232 P 15	32	32	32	16	170	34.0	-5	-5	1.30	GI082	PS04	
PSDNN 3232 P 19	32	32	32	16	170	42.0	-5	-5	1.25	GI026	PS02	
PSDNN 4040 S 19	40	40	40	20	250	42.0	-5	-5	3.03	GI026	PS02	
PSDNN 4040 S 25	40	40	40	20	250	48.0	-5	-5	3.02	GI027	PS03	
PSDNN 5050 T 25	50	50	50	25	300	50.0	-5	-5	5.65	GI027	PS03	

GI029	SN.. 1204..
GI082	SN.. 1506..
GI026	SN.. 1906..
GI027	SN.. 2507..

PS01	PSS 512	CL 012	CS 608	3.0	M 8x1	20.7	TR 12	MT 05	HXK 3
PS02	PSS 519	CL 019	CS 610	3.5	M 10x1	27.2	TR 19	MT 06	HXK 4
PS03	PSS 525	CL 025	CS 612	4.0	M 12x1	36	TR 25	MT 08	HXK 5
PS04	PSS 515	CL 016	CS 618	3.0	M 8x1	22.5	TR 15	MT 07	HXK 3

PSKN(RL) EXT



PRAMET







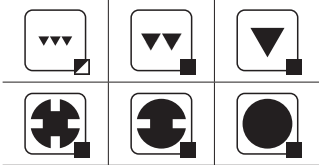
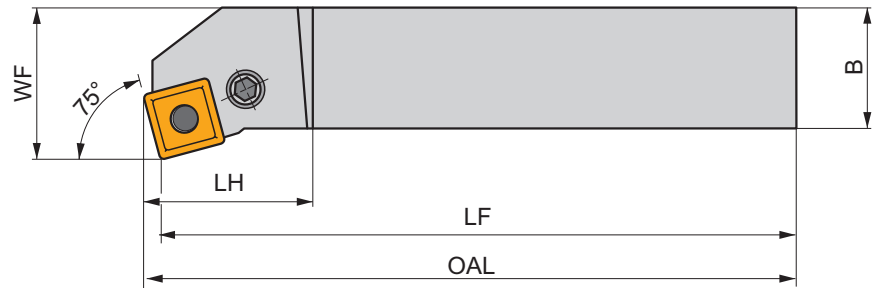
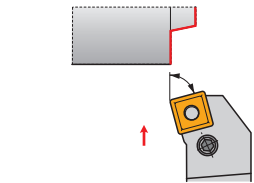





External Lever Lock Holder, 75° (Face Turning) Cutting Angle for SN.. Inserts

External Right/Left hand lever lock tool holder with 75° cutting angle. Suited for face turning without shoulder and chamfering with negative SN.. inserts. Body treated for longer tool life.



Product	H	B	HF	WF	LF	OAL	LH	LAMS	GAMO	kg		
	(mm)	(mm)	(mm)	(mm)	(mm)	(mm)	(mm)	(°)	(°)			
R	PSKNR 2020 K 12	20	20	20	25	125	128.1	28.0	-6	-6	0.42	GI029 PS01
	PSKNR 2525 M 12	25	25	25	32	150	153.1	28.0	-6	-6	0.76	GI029 PS01
	PSKNR 3232 P 19	32	32	32	40	170	174.6	45.0	-6	-6	1.40	GI026 PS02
	PSKNR 4040 S 19	40	40	40	50	250	254.6	45.0	-6	-6	3.23	GI026 PS02
	PSKNR 4040 S 25	40	40	40	50	250	256.5	50.0	-6	-6	3.28	GI027 PS03
	PSKNR 3232 P 15	32	32	32	40	170	173.9	42.0	-6	-6	1.40	GI082 PS04
	PSKNR 5050 T 25	50	50	50	60	300	306.5	50.0	-6	-6	6.05	GI027 PS03
	PSKNR 5050 T 2509	50	50	50	60	300	306.5	50.0	-6	-6	6.20	GI040 PS03
L	PSKNL 2020 K 12	20	20	20	25	125	128.1	28.0	-6	-6	0.42	GI029 PS01
	PSKNL 2525 M 12	25	25	25	32	150	153.1	28.0	-6	-6	0.79	GI029 PS01
	PSKNL 3232 P 15	32	32	32	40	170	173.9	42.0	-6	-6	1.05	GI082 PS04
	PSKNL 3232 P 19	32	32	32	40	170	174.6	42.0	-6	-6	1.41	GI026 PS02
	PSKNL 4040 S 19	40	40	40	50	250	254.6	45.0	-6	-6	3.26	GI026 PS02
	PSKNL 4040 S 25	40	40	40	50	250	256.5	50.0	-6	-6	3.28	GI027 PS03
	PSKNL 5050 T 25	50	50	50	60	300	306.5	50.0	-6	-6	6.00	GI027 PS03
	PSKNL 5050 T 2509	50	50	50	60	300	306.5	50.0	-6	-6	6.20	GI040 PS03

GI029	SN.. 1204..
GI082	SN.. 1506..
GI026	SN.. 1906..
GI027	SN.. 2507..
GI040	SN.. 2509..

									
PS01	PSS 512	CL 012	CS 608	3.0	M 8x1	20.7	TR 12	MT 05	HXK 3
PS02	PSS 519	CL 019	CS 610	3.5	M 10x1	27.2	TR 19	MT 06	HXK 4
PS03	PSS 525	CL 025	CS 612	4.0	M 12x1	36	TR 25	MT 08	HXK 5
PS04	PSS 515	CL 016	CS 618	3.0	M 8x1	22.5	TR 15	MT 07	HXK 3

PSSN(RL) EXT



PRAMET

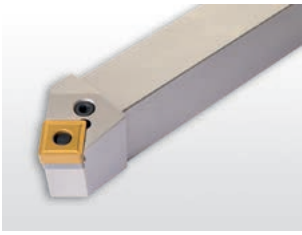

External Lever Lock Holder with 45° Cutting Angle for SN.. Inserts

External Right/Left hand lever lock tool holder with 45° cutting angle. Suited for longitudinal and face turning without shoulder, copy and taper turning and chamfering with negative SN.. inserts. Body treated for longer tool life.

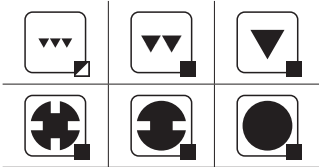
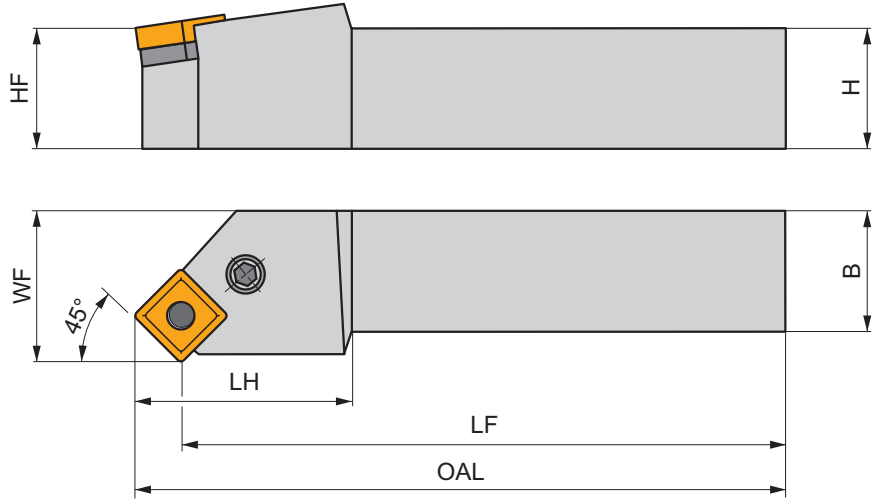
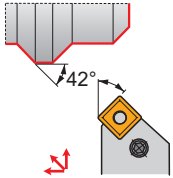

Product	H	B	HF	WF	LF	OAL	LH	LAMS	GAMO	kg		
	(mm)	(mm)	(mm)	(mm)	(mm)	(mm)	(mm)	(°)	(°)			
R	PSSNR 2020 K 12	20	20	20	25	125	133.3	28.0	0	-8	0.42	GI029 PS01
	PSSNR 2525 M 12	25	25	25	32	150	158.3	28.0	0	-8	0.75	GI029 PS01
	PSSNR 3225 P 15	32	25	32	32	170	180.2	42.0	0	-8	1.11	GI082 PS04
	PSSNR 3232 P 19	32	32	32	40	170	182.5	45.0	0	-8	1.42	GI026 PS02
	PSSNR 5050 T 25	50	50	50	60	300	316	50.0	0	-8	6.00	GI027 PS03
	PSSNR 4040 S 19	40	40	40	50	250	262.5	45.0	0	-8	3.18	GI026 PS02
	PSSNR 5050 T 2509	50	50	50	60	300	316	50.0	0	-8	6.05	GI040 PS03
L	PSSNL 2020 K 12	20	20	20	25	125	133.3	28.0	0	-8	0.41	GI029 PS01
	PSSNL 2525 M 12	25	25	25	32	150	158.3	28.0	0	-8	0.76	GI029 PS01
	PSSNL 3225 P 15	32	25	32	32	170	180.2	42.0	0	-8	1.13	GI082 PS04
	PSSNL 3232 P 19	32	32	32	40	170	182.5	45.0	0	-8	1.43	GI026 PS02
	PSSNL 4040 S 19	40	40	40	50	250	262.5	45.0	0	-8	3.16	GI026 PS02
	PSSNL 5050 T 25	50	50	50	60	300	316	50.0	0	-8	6.00	GI027 PS03
	PSSNL 5050 T 2509	50	50	50	60	300	316	50.0	0	-8	5.98	GI040 PS03

GI029	SN.. 1204..
GI082	SN.. 1506..
GI026	SN.. 1906..
GI027	SN.. 2507..
GI040	SN.. 2509..

PS01	PSS 512	CL 012	CS 608	3.0	M 8x1	20.7	TR 12	MT 05	HXK 3
PS02	PSS 519	CL 019	CS 610	3.5	M 10x1	27.2	TR 19	MT 06	HXK 4
PS03	PSS 525	CL 025	CS 612	4.0	M 12x1	36	TR 25	MT 08	HXK 5
PS04	PSS 515	CL 016	CS 618	3.0	M 8x1	22.5	TR 15	MT 07	HXK 3

C.-DSDNN EXT

P
M
K
N
S
H

PRAMET

D



External PSC Quick Change Tool, Double Clamp, 45° Cutting Angle, SN.. Inserts

External neutral double clamp tool, through coolant, with 45° cutting angle for longitudinal turning without shoulder, copy turning, taper turning and chamfer turning with negative SN.. inserts. Polygon Shank Coupling. Body treated for longer tool life.

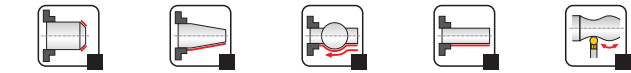
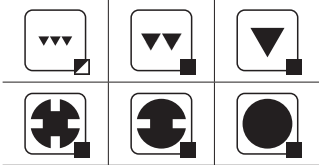
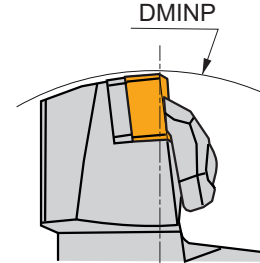
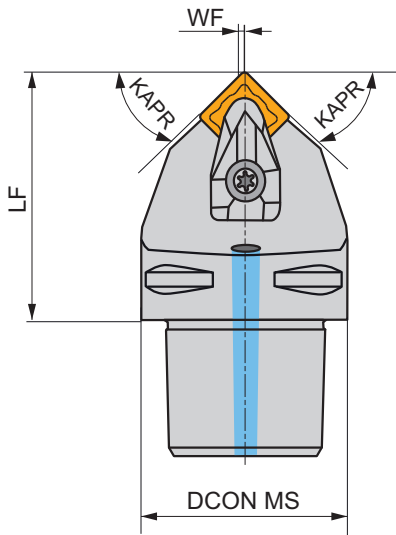
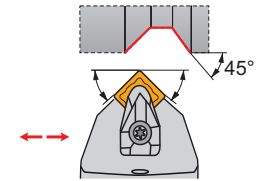

Product	DCON MS (mm)	DMINP (mm)	WF (mm)	LF (mm)	KAPR (°)	LAMS (°)	GAMO (°)		kg			
N C4-DSDNN-00050-12	40	140	0.3	50	45	-6	-6	✓	0.39	GI029	C-DS12-2	AT003
C5-DSDNN-00060-12	50	165	0.3	60	45	-6	-6	✓	0.69	GI029	C-DS12-2	AT003
C6-DSDNN-00070-19	63	195	0.5	70	45	-6	-6	✓	1.28	GI026	C-DS19	-

GI029	SN.. 1204..
GI026	SN.. 1906..

C-DS12-2	DCS 12	3.9	DSS 425-01	US 2002-T15P	FLAG T15P/3,5	-	CN 045-01
C-DS19	DCS 19	6.4	DSS 425-04	US 2007-T20P	-	LK T20P	CN 045-01

AT003a	SN.. 1207..	-	DSS 425-02
AT003b	CER SN.N 1204..	DCS 12C4	-
AT003c	CER SN.A 1204..	DCS 12C2	-

C.-DSKN(RL) EXT

P
M
K
N
S
H

PRAMET

D



Ext. PSC Quick Change Tool, Double Clamp, 75° (Face) Cutting Angle, SN.. Inserts

External Right/Left hand double clamp tool, through coolant, with 75° cutting angle for face turning without shoulder and chamfering with negative SN.. inserts. Polygon Shank Coupling. Body treated for longer tool life.

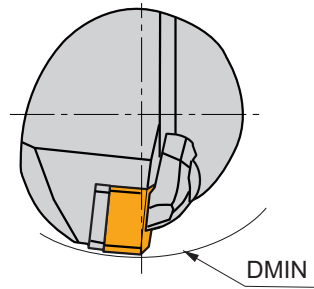
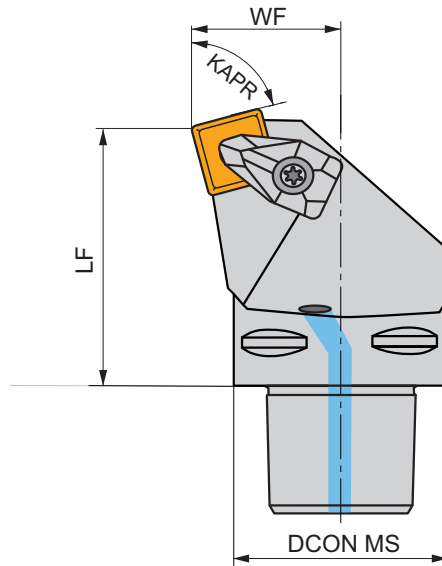
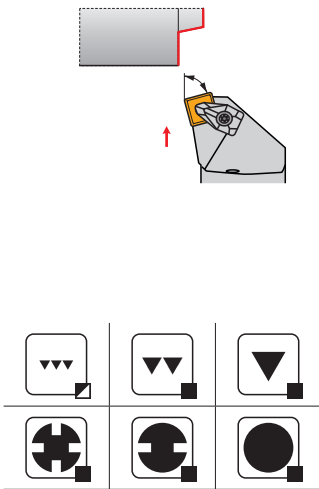

Product	DCON MS (mm)	DMIN (mm)	WF (mm)	LF (mm)	KAPR (°)	LAMS (°)	GAMO (°)		kg			
R C4-DSKNR-27050-12	40	110	27	50	75	-6	-6	✓	0.46	GI029	C-DS12-1	AT003
L C4-DSKNL-27050-12	40	110	27	50	75	-6	-6	✓	0.46	GI029	C-DS12-1	AT003

	GI029		SN.. 1204..
--	-------	--	-------------

	C-DS12-1		DCS 12		3.9		DSS 425-01		US 2002-T15P		FLAG T15P/3,5		CN 034-01
--	----------	--	--------	--	-----	--	------------	--	--------------	--	---------------	--	-----------

	AT003a		SN.. 1207..		-		DSS 425-02
	AT003b		CER SN.N 1204..		DCS 12C4	-	-
	AT003c		CER SN.A 1204..		DCS 12C2	-	-

C.-DSRN(RL) EXT

P
M
K
N
S
H

PRAMET

D



External PSC Quick Change Tool, Double Clamp, 75° Cutting Angle, SN.. Inserts

External Right/Left hand double clamp tool, through coolant, with 75° cutting angle for longitudinal turning without shoulder, taper turning and chamfering with negative SN.. inserts. Polygon Shank Coupling. Body treated for longer tool life.

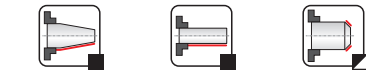
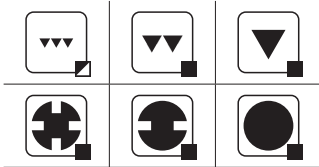
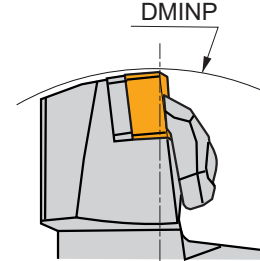
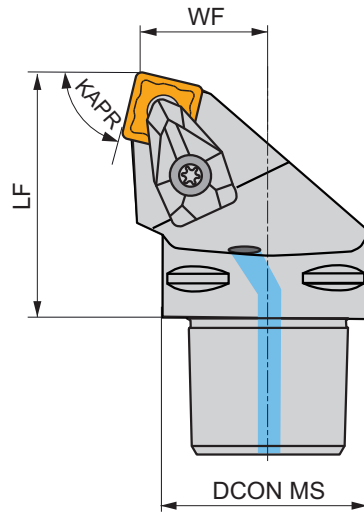
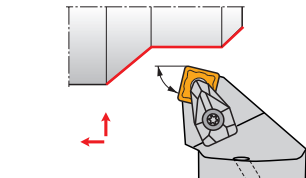

Product	DCON MS (mm)	DMINP (mm)	WF (mm)	LF (mm)	KAPR (°)	LAMIS (°)	GAMMO (°)					
R C4-DSRNR-22050-12	40	140	22	50	75	-6	-6	✓	0.40	G1029	C-DS12-1	AT003
	C6-DSRNR-35065-19	63	190	35	65	75	-6	-6	✓	1.30	G1026	C-DS19
L C4-DSRNL-22050-12	40	140	22	50	75	-6	-6	✓	0.41	G1029	C-DS12-1	AT003
	C6-DSRNL-35065-19	63	190	35	65	75	-6	-6	✓	1.30	G1026	C-DS19

G1029		SN.. 1204..	
G1026		SN.. 1906..	

C-DS12-1	DCS 12	3.9	DSS 425-01	US 2002-T15P	FLAG T15P/3,5	-	CN 034-01
C-DS19	DCS 19	6.4	DSS 425-04	US 2007-T20P	-	LK T20P	CN 045-01

AT003a	SN.. 1207..	-	DSS 425-02
AT003b	CER SN.N 1204..	DCS 12C4	-
AT003c	CER SN.A 1204..	DCS 12C2	-

C.-DSSN(RL) EXT

P
M
K
N
S
H

PRAMET

D



External PSC Quick Change Tool, Double Clamp, 45° Cutting Angle, SN.. Inserts

External Right/Left hand double clamp tool, through coolant, with 45° cutting angle for longitudinal and face turning without shoulder, taper turning, copy turning and chamfering with negative SN.. insert. Polygon Shank Coupling. Body treated for longer tool life.

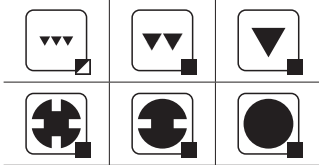
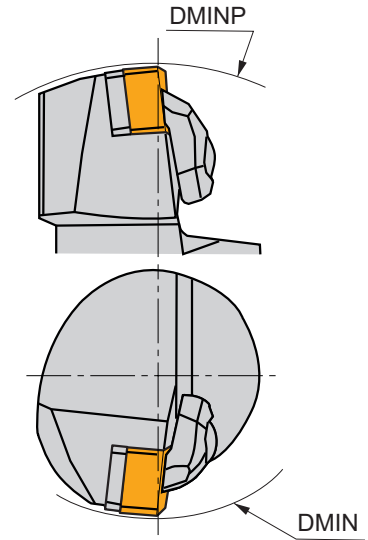
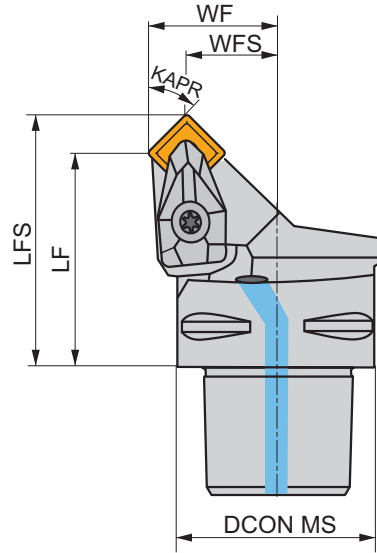
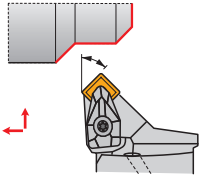

Product	DCON MS	DMIN	DMINP	WF	WFS	LF	LFS	KAPR	LAMS	GAMO					
	(mm)	(mm)	(mm)	(mm)	(mm)	(mm)	(mm)	(°)	(°)	(°)					
R C4-DSSNR-27042-12	40	110	140	27	18.7	42	50.3	45	0	-8	✓	0.38	GI029	C-DS12-1	AT003
	C5-DSSNR-35052-12	50	110	165	35	26.7	52	60.3	45	0	-8	✓	0.68	GI029	C-DS12-3
L C4-DSSNL-27042-12	40	110	140	27	18.7	42	50.3	45	0	-8	✓	0.36	GI029	C-DS12-1	AT003
	C5-DSSNL-35052-12	50	110	165	35	26.7	52	60.3	45	0	-8	✓	0.69	GI029	C-DS12-3

GI029	SN.. 1204..

C-DS12-1	DCS 12	3.9	DSS 425-01	US 2002-T15P	FLAG T15P/3,5	CN 034-01
C-DS12-3	DCS 12	3.9	DSS 425-01	US 2002-T15P	FLAG T15P/3,5	CN 034-02

AT003a	SN.. 1207..	-	DSS 425-02
AT003b	CER SN.N 1204..	DCS 12C4	-
AT003c	CER SN.A 1204..	DCS 12C2	-

KHP-SBN(RL)



PRAMET



Modular KHP Lever Lock Turning Cartridge, 75° Cutting Angle for SN.. Inserts

Dovetailed Right/Left hand lever lock turning cartridge, 75° cutting angle, for mounting on DKH tool holder shank. Suited for heavy longitudinal turning without shoulder, face turning, taper and chamfer turning with negative SN.. inserts. Tool holder treated for longer tool life.

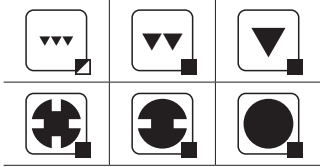
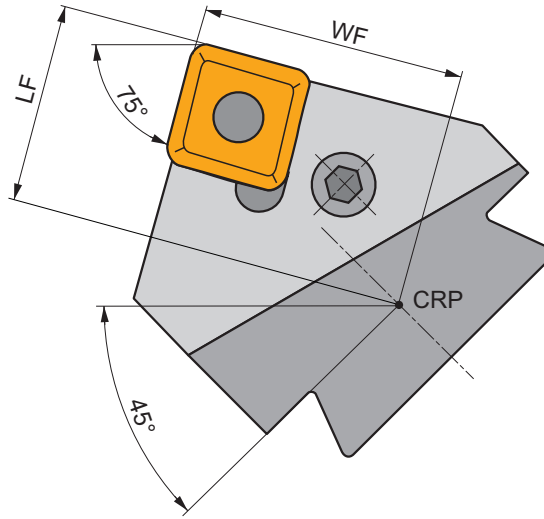
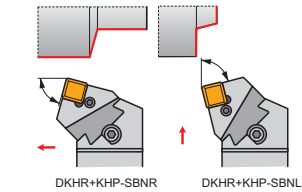

Product	WF (mm)	LF (mm)	LAMS (°)	GAMO (°)	kg		
R KHP-SBNR 19	47	36	-6	-6	1.51	GI026	PS50
KHP-SBNR 25	47	36	-6	-6	1.47	GI027	PS60
KHP-SBNR 2509	47	36	-6	-6	1.45	GI040	PS70
L KHP-SBNL 19	47	36	-6	-6	1.92	GI026	PS50
KHP-SBNL 25	47	36	-6	-6	1.48	GI027	PS60
KHP-SBNL 2509	47	36	-6	-6	1.46	GI040	PS70

GI026	SN.. 1906..
GI027	SN.. 2507..
GI040	SN.. 2509..

PS50	SNU 190416	PU 05	US 38	8.0	M 10x1	29	NT 06	MT 06	HXK 5
PS60	SNU 250624	PU 06	US 39	8.0	M 10x1	33	NT 08	MT 08	HXK 5
PS70	SNU 250624	PU 06	US 47	8.0	M 12x1	36	NT 08	MT 08	HXK 5

KHP-SSN(RL)



PRAMET



Modular KHP Lever Lock Turning Cartridge, 45° Cutting Angle for SN.. Inserts

Dovetailed Right/Left hand lever lock turning cartridge, 45° cutting angle, for mounting on DKH tool holder shank. Suited for heavy longitudinal turning without shoulder, face turning, copy, taper and chamfer turning with negative SN.. inserts. Tool holder treated for longer tool life.

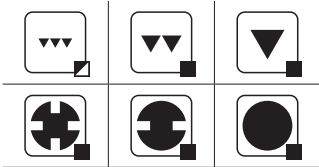
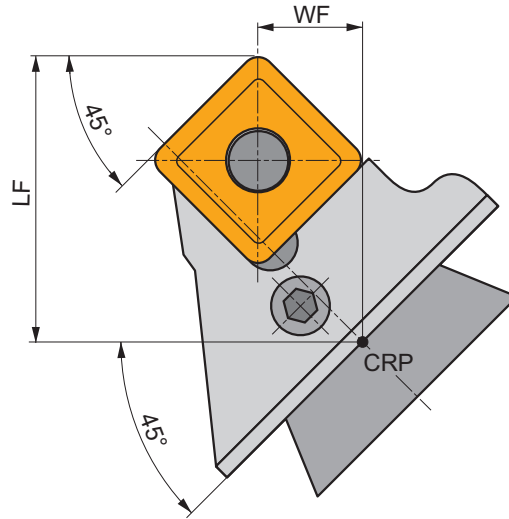
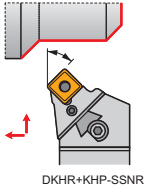

Product	WF (mm)	LF (mm)	LAMS (°)	GAMO (°)	kg		
R KHP-SSNR 25	15	45	-6	-6	0.98	G1027	PS60
L KHP-SSNL 25	15	45	-6	-6	1.30	G1027	PS60

G1027	SN.. 2507..

PS60	SNU 250624	PU 06	US 39	8.0	M 10x1	33	NT 08	MT 08	HXK 5

DKH(RL)



External Tool Holder Shank for KHP/KHS Heavy Turning Cartridges

Dovetailed Right/Left hand modular tool shank for KHP/KHS cartridges. Suited for heavy turning applications. Body treated for longer tool life.

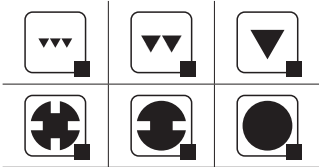
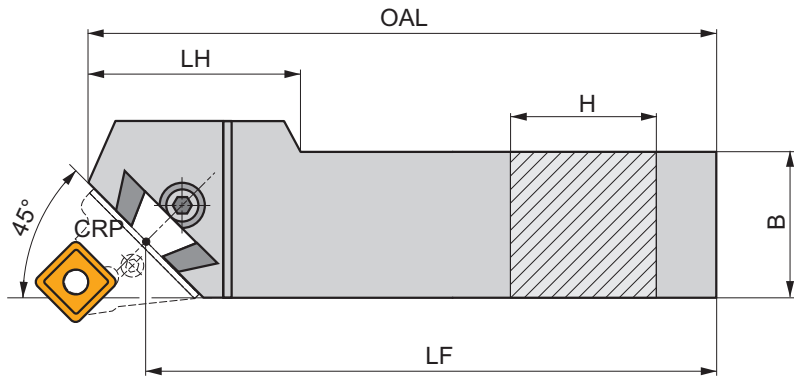
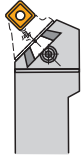

Product	H	B	LF	OAL	LH	kg		
	(mm)	(mm)	(mm)	(mm)	(mm)			
R DKHR 4050 V	40	50	400	425	100.0	7.10	GI098	DKH10
	50	60	450	475	110.0	11.30	GI098	DKH10
	60	80	450	485	90.0	19.65	GI098	DKH10
L DKHL 4050 V	40	50	400	425	100.0	7.10	GI098	DKH10
	50	60	450	475	110.0	11.30	GI098	DKH10
	60	80	450	485	90.0	19.28	GI098	DKH10

GI098	KHP	KHS

DKH10	SR 14	HXK 10

PSKN(RL) INT

P
M
K
N
S
H

PRAMET

P



Internal Lever Lock Boring Bar with 75° Cutting Angle for SN.. Inserts

Internal Right/Left hand lever lock boring bar, through coolant, 75° cutting angle for SN.. inserts. For internal taper and longitudinal turning without shoulder and chamfer turning. Body treated for longer tool life.

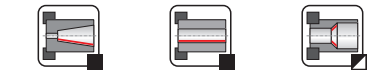
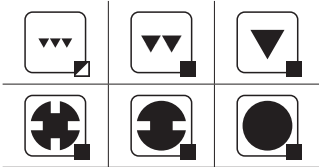
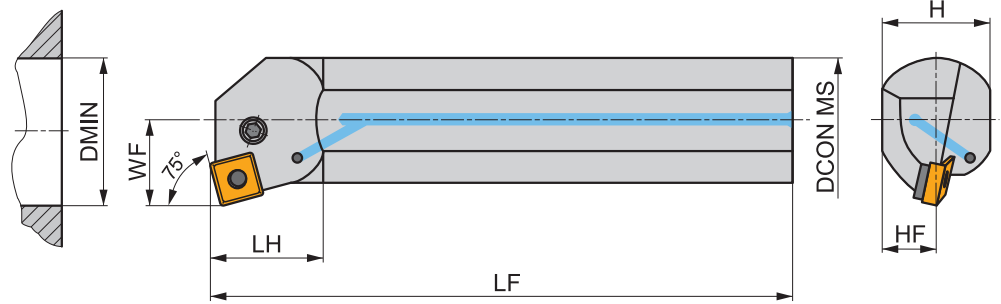
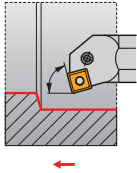

Product	DCON MS	DMIN	WF	H	B	LF	LAMS	GAMO				
	(mm)	(mm)	(mm)	(mm)	(mm)	(mm)	(°)	(°)				
R A32S-PSKNR 12	32	39	22	30	-	250	-10	-6	✓	1.45	GI029	PS06
A40T-PSKNR 15	40	48	27	37	-	300	-11	-6	✓	2.90	GI082	PS04
A50U-PSKNR 15	50	61	35	47	-	350	-11	-6	✓	5.20	GI082	PS04
A50U-PSKNR 19	50	63	35	47	48.5	350	-12	-6	✓	5.20	GI026	PS07
L A50U-PSKNL 15	50	61	35	47	-	350	-11	-6	✓	5.20	GI082	PS04

GI029	SN.. 1204..
GI082	SN.. 1506..
GI026	SN.. 1906..

PS04	PSS 515	CL 016	CS 618	3.0	M 8x1	22.5	TR 15	MT 07	HXK 3
PS06	PSS 512	CL 312	CS 648	3.0	M 8x1	17	TR 12	MT 05	HXK 3
PS07	PSS 519	CL 219	CS 710	3.5	M 10x1	30.4	TR 29	MT 06	HXK 4

DTFN(RL) EXT

P
M
K
N
S
H

PRAMET

D



External Double Clamp Holder with 91° (Face) Cutting Angle for TN.. Inserts

External Right/Left hand double clamp tool holder with 91° cutting angle. Suited for face turning with shoulder and chamfering with negative TN.. inserts. Body treated for longer tool life.

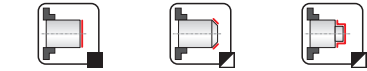
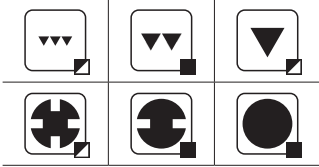
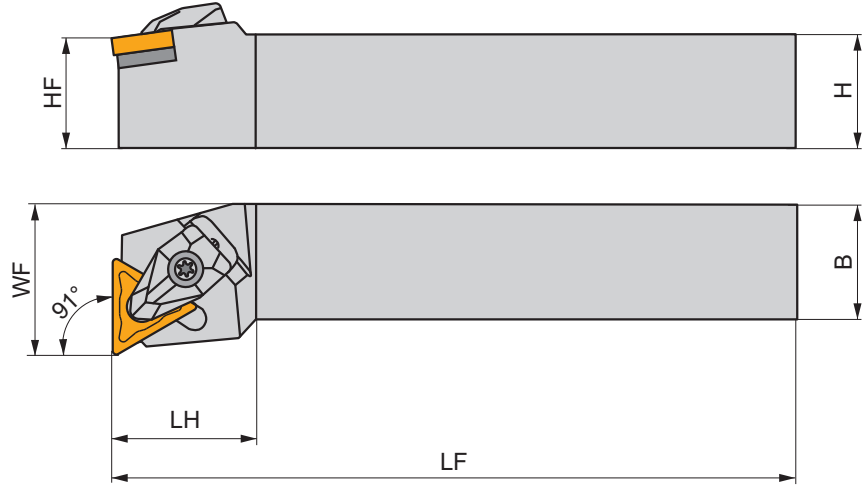
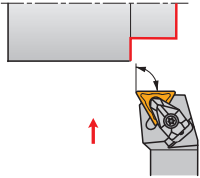

Product	H (mm)	B (mm)	HF (mm)	WF (mm)	LF (mm)	LH (mm)	LAMS (°)	GAMO (°)	kg		
R DTFNR 2020 K 16	20	20	20	25	125	23.6	-6	-6	0.43	G1024	DT16
DTFNR 2525 M 16	25	25	25	32	150	23.6	-6	-6	0.77	G1024	DT16
DTFNR 2525 M 22	25	25	25	32	150	30.5	-6	-6	0.79	G1025	DT22
L DTFNL 2020 K 16	20	20	20	25	125	23.6	-6	-6	0.43	G1024	DT16
DTFNL 2525 M 16	25	25	25	32	150	23.6	-6	-6	0.76	G1024	DT16

G1024	TN.. 1604..
G1025	TN.. 2204..

DT16	DCS 09	1.7	DTS 315-02	US 2004-T09P	FLAG T09P
DT22	DCS 12	3.9	DTS 315-04	US 2002-T15P	FLAG T15P/3,5

DTGN(RL) EXT

P
M
K
N
S
H

PRAMET

D



External Double Clamp Holder with 91° Cutting Angle for TN.. Inserts

External Right/Left hand double clamp tool holder with 91° cutting angle. Suited for longitudinal turning with shoulder, taper turning and chamfering with negative TN.. inserts. Body treated for longer tool life.

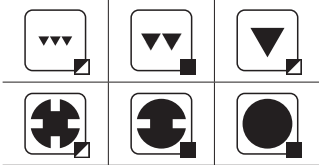
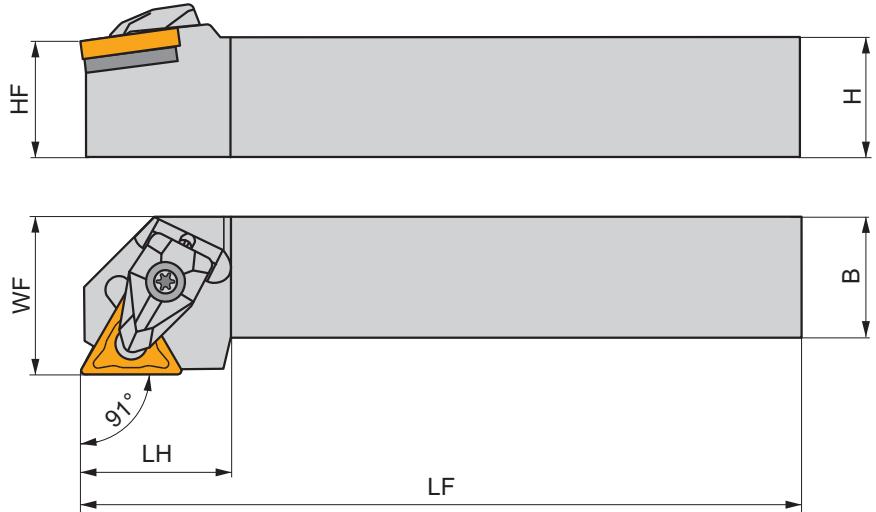
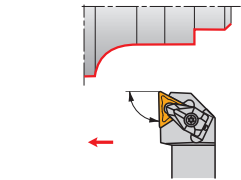

Product	H (mm)	B (mm)	HF (mm)	WF (mm)	LF (mm)	LH (mm)	LAMS (°)	GAMO (°)	kg	GI024	GI025
R DTGNR 2020 K 16	20	20	20	25	125	25.4	-6	-6	0.42	GI024	DT16
DTGNR 2525 M 16	25	25	25	32	150	24.6	-6	-6	0.76	GI024	DT16
DTGNR 2525 M 22	25	25	25	32	150	32.1	-6	-6	0.81	GI025	DT22
DTGNR 3232 P 22	32	32	32	40	170	33.1	-6	-6	1.41	GI025	DT22
L DTGNL 2020 K 16	20	20	20	25	125	25.4	-6	-6	0.44	GI024	DT16
DTGNL 2525 M 16	25	25	25	32	150	24.6	-6	-6	0.78	GI024	DT16
DTGNL 2525 M 22	25	25	25	32	150	32.1	-6	-6	0.78	GI025	DT22

GI024	GI025	TN.. 1604..	TN.. 2204..

DT16	DCS 09	1.7	DTS 315-02	US 2004-T09P	FLAG T09P
DT22	DCS 12	3.9	DTS 315-04	US 2002-T15P	FLAG T15P/3,5

MTJN(RL) EXT



PRAMET



External Multi-Clamp Holder with 93° Cutting Angle for TN.. Inserts

External Right/Left hand multi-clamp tool holder with 93° cutting angle. Suited for longitudinal turning with shoulder, taper and copy turning up to 22°, and chamfering with negative TN.. inserts. Body treated for longer tool life.

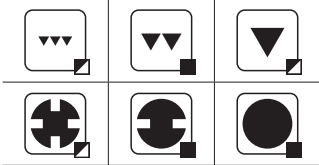
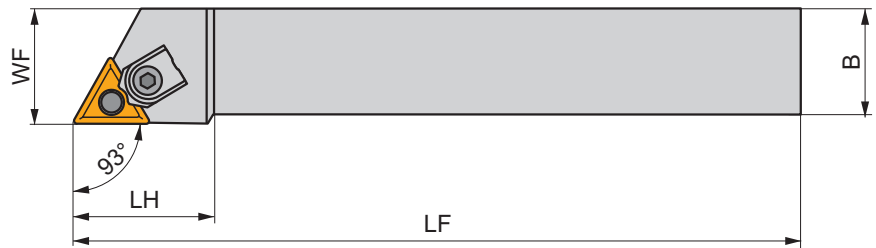
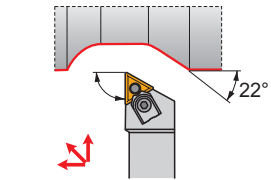

Product	H (mm)	B (mm)	HF (mm)	WF (mm)	LF (mm)	LH (mm)	LAMS (°)	GAMO (°)	kg	GI024	GI025	MT16	MT22
R MTJNR 2020 K 16	20	20	20	25	125	34.0	-6	-6	0.42	GI024	GI024	MT16	
MTJNR 2525 M 16	25	25	25	32	150	34.0	-6	-6	0.76	GI024	GI024	MT16	
MTJNR 3232 P 22	32	32	32	40	175	42.0	-6	-6	1.37	GI025	GI025	MT22	
L MTJNL 2020 K 16	20	20	20	25	125	34.0	-6	-6	0.43	GI024	GI024	MT16	
MTJNL 2525 M 16	25	25	25	32	150	34.0	-6	-6	0.75	GI024	GI024	MT16	
MTJNL 3232 P 22	32	32	32	40	175	42.0	-6	-6	1.37	GI025	GI025	MT22	

GI024	GI025	TN.. 1604..	TN.. 2204..

MT16	UE 16	3.0	MTN 160312	UC 52	HS 93	HXK 5
MT22	UE 22	5.0	MTN 220612	UC 61	HS 94	HXK 5

PTFN(RL) EXT



PRAMET



External Lever Lock Holder with 90° (Face) Cutting Angle for TN.. Inserts

External Right/Left hand lever lock tool holder with 90° cutting angle. Suited for face turning with shoulder and chamfering with negative TN.. inserts. Body treated for longer tool life.

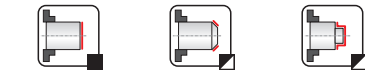
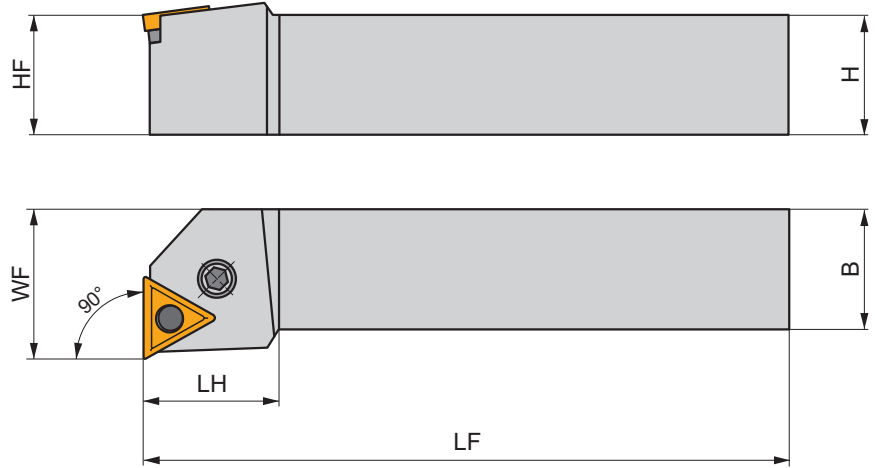
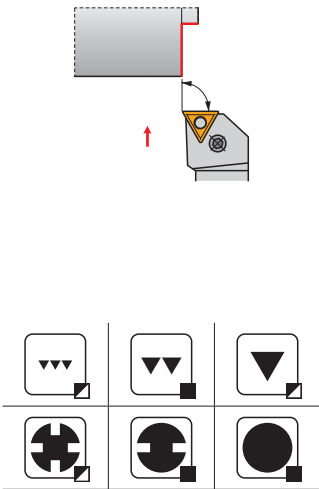

Product	H (mm)	B (mm)	HF (mm)	WF (mm)	LF (mm)	LH (mm)	LAMS (°)	GAMO (°)	kg		
R PTFNR 2020 K 16	20	20	20	25	125	22.0	-6	-6	0.41	GI024	PT01
PTFNR 2525 M 16	25	25	25	32	150	28.0	-6	-6	0.75	GI024	PT01
PTFNR 3225 P 22	32	25	32	32	170	36.0	-6	-6	1.05	GI025	PT02
PTFNR 4040 S 27	40	40	40	50	250	45.0	-6	-6	3.22	GI077	PT03
L PTFNL 2525 M 22	25	25	25	32	150	28.0	-6	-6	0.70	GI025	PT02
PTFNL 3225 P 22	32	25	32	32	170	36.0	-6	-6	1.14	GI025	PT02
PTFNL 4040 S 27	40	40	40	50	250	45.0	-6	-6	3.16	GI077	PT03

GI024	TN.. 1604..
GI025	TN.. 2204..
GI077	TN.. 2706..

PT01	PTS 416	CL 009	CS 606	2.0	M 6x1	16.7	TR 09	MT 04	HXK 2.5
PT02	PTS 422	CL 012	CS 608	3.0	M 8x1	20.7	TR 12	MT 05	HXK 3
PT03	PTS 427	CL 015	CS 708	3.0	M 8x1	23.5	TR 15	MT 07	HXK 3

PTGN(RL) EXT



PRAMET

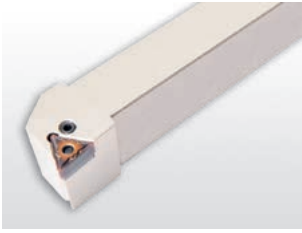

External Lever Lock Holder with 90° Cutting Angle for TN.. Inserts

External Right/Left hand lever lock tool holder with 90° cutting angle. Suited for longitudinal turning with shoulder, taper turning and chamfering with negative TN.. inserts. Body treated for longer tool life.

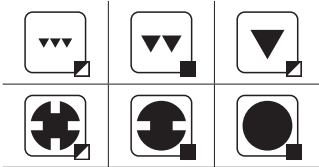
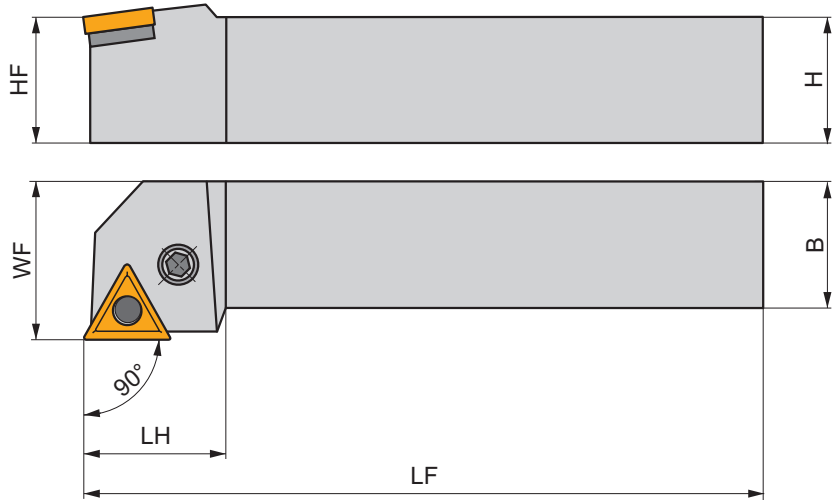
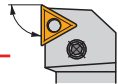

Product	H	B	HF	WF	LF	LH	LAMS	GAMO	kg			
	(mm)	(mm)	(mm)	(mm)	(mm)	(mm)	(°)	(°)				
R	PTGNR 1616 H 16	16	16	16	20	100	22.0	-6	-6	0.20	GI024	PT01
	PTGNR 2020 K 16	20	20	20	25	125	22.0	-6	-6	0.40	GI024	PT01
	PTGNR 2525 M 16	25	25	25	32	150	28.0	-6	-6	0.73	GI024	PT01
	PTGNR 2525 M 22	25	25	25	32	150	28.0	-6	-6	0.76	GI025	PT02
	PTGNR 3232 P 22	32	32	32	40	170	28.0	-6	-6	1.35	GI025	PT02
PTGNR 4040 S 27	40	40	40	50	250	45.0	-6	-6	3.15	GI077	PT03	
L	PTGNL 1616 H 16	16	16	16	20	100	22.0	-6	-6	0.21	GI024	PT01
	PTGNL 2020 K 16	20	20	20	25	125	22.0	-6	-6	0.40	GI024	PT01
	PTGNL 2525 M 16	25	25	25	32	150	28.0	-6	-6	0.76	GI024	PT01
	PTGNL 2525 M 22	25	25	25	32	150	28.0	-6	-6	0.76	GI025	PT02
	PTGNL 3232 P 22	32	32	32	40	170	28.0	-6	-6	1.34	GI025	PT02
PTGNL 4040 S 27	40	40	40	50	250	45.0	-6	-6	3.14	GI077	PT03	

GI024	TN.. 1604..
GI025	TN.. 2204..
GI077	TN.. 2706..

PT01	PTS 416	CL 009	CS 606	2.0	M 6x1	16.7	TR 09	MT 04	HXX 2.5
PT02	PTS 422	CL 012	CS 608	3.0	M 8x1	20.7	TR 12	MT 05	HXX 3
PT03	PTS 427	CL 015	CS 708	3.0	M 8x1	23.5	TR 15	MT 07	HXX 3

PTTN(RL) EXT

P
M
K
N
S
H

PRAMET

P



External Lever Lock Holder with 60° Cutting Angle for TN.. Inserts

External Right/Left hand lever lock tool holder with 60° cutting angle. Suited for longitudinal turning with shoulder, taper and copy turning up to 30° and chamfering with negative TN.. inserts. Body treated for longer tool life.

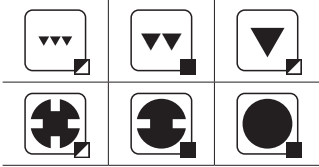
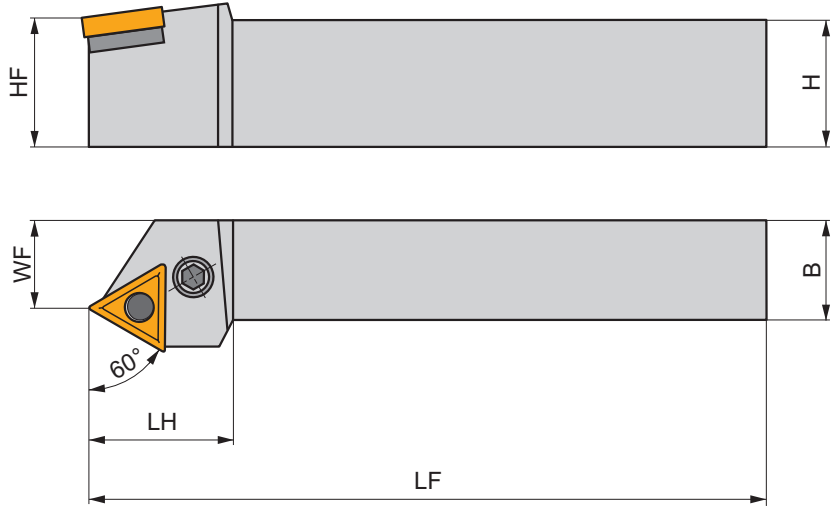
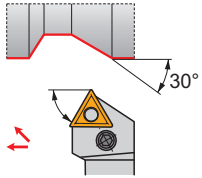

Product	H (mm)	B (mm)	HF (mm)	WF (mm)	LF (mm)	LH (mm)	LAMS (°)	GAMO (°)	kg		
R PTTNR 2020 K 16	20	20	20	17	125	28.0	-6	-6	0.43	GI024	PT01
PTTNR 2525 M 16	25	25	25	22	150	28.0	-6	-6	0.63	GI024	PT01
PTTNR 2525 M 22	25	25	25	22	150	34.0	-6	-6	0.73	GI025	PT02
PTTNR 3225 P 22	32	25	32	22	170	34.0	-6	-6	1.07	GI025	PT02
L PTTNL 2020 K 16	20	20	20	17	125	28.0	-6	-6	0.38	GI024	PT01
PTTNL 3225 P 22	32	25	32	22	170	34.0	-6	-6	1.04	GI025	PT02

GI024	TN.. 1604..
GI025	TN.. 2204..

PT01	PTS 416	CL 009	CS 606	2.0	M 6x1	16.7	TR 09	HXK 2.5
PT02	PTS 422	CL 012	CS 608	3.0	M 8x1	20.7	TR 12	HXK 3

C.-DTJN(RL) EXT

P
M
K
N
S
H

PRAMET

D



External PSC Quick Change Tool, Double Clamp, 93° Cutting Angle, TN.. Inserts

External Right/Left hand double clamp tool, through coolant, with 93° cutting angle for longitudinal turning with shoulder, taper turning and chamfering with negative TN.. inserts. Polygon Shank Coupling. Body treated for longer tool life.

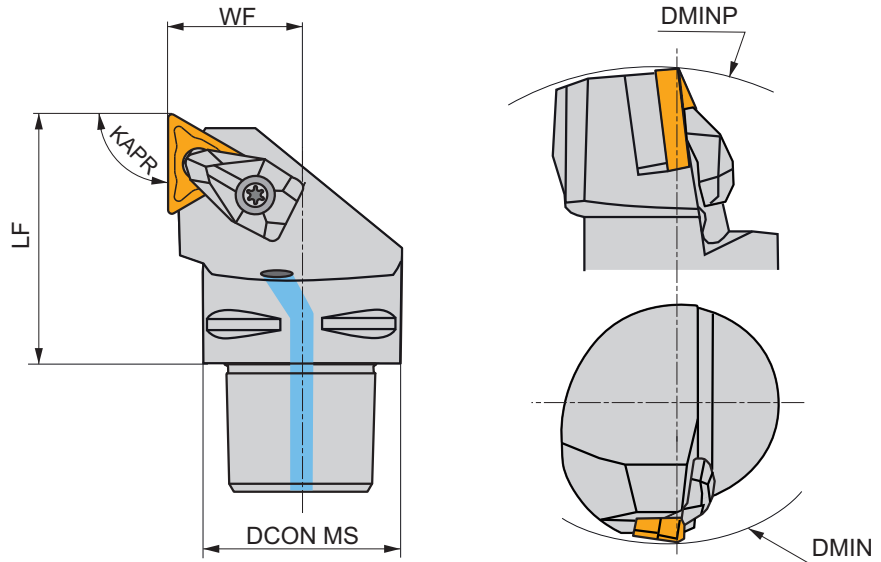
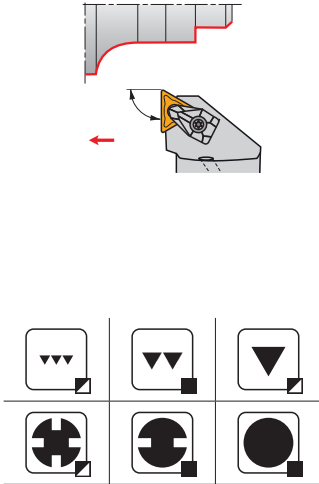

Product	DCON MS	DMIN	DMINP	WF	LF	KAPR	LAMS	GAMO				
	(mm)	(mm)	(mm)	(mm)	(mm)	(°)	(°)	(°)				
R C4-DTJNR-27050-16	40	110	140	27	50	93	-6	-6	✓	0.43	GI024	C-DT16
	C5-DTJNR-35060-16	50	110	165	35	60	93	-6	-6	✓	0.79	GI024
L C4-DTJNL-27050-16	40	110	140	27	50	93	-6	-6	✓	0.43	GI024	C-DT16
	C5-DTJNL-35060-16	50	110	165	35	60	93	-6	-6	✓	0.79	GI024

	GI024		TN.. 1604..
--	-------	--	-------------

C-DT16	DCS 09	1.7	DTS 315-02	US 2004-T09P	FLAG T09P	CN 045-01

DTFN(RL) INT

P
M
K
N
S
H

PRAMET

D



Internal Double Clamp Holder with 91° Cutting Angle for TN.. Inserts

Internal Right/Left hand double clamp boring bar, through coolant, 91° cutting angle for TN.. inserts. For internal taper and longitudinal turning with shoulder and chamfer turning. Body treated for longer tool life.

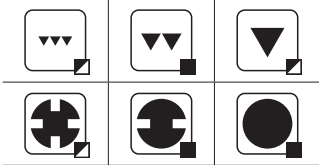
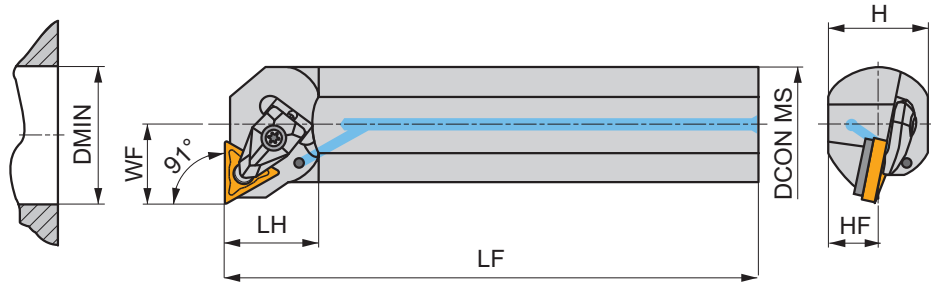
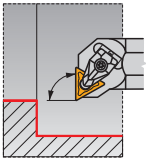

Product	DCON MS	DMIN	WF	H	HF	LF	LH	LAMS	GAMO				
	(mm)	(mm)	(mm)	(mm)	(mm)	(mm)	(mm)	(°)	(°)				
R	A25T-DTFNR 16	25	32	17	23	11.5	300	32.0	-12	-6	✓	0.96	GI024 DTI16
	A32T-DTFNR 16	32	40	22	30	15	300	33.0	-10	-6	✓	1.67	GI024 DTI16
	A40T-DTFNR 22	40	50	27	37	18.5	300	36.0	-13	-6	✓	2.58	GI025 DT22
L	A25T-DTFNL 16	25	32	17	23	11.5	300	32.0	-12	-6	✓	0.96	GI024 DTI16
	A32T-DTFNL 16	32	40	22	30	15	300	33.0	-10	-6	✓	1.67	GI024 DTI16
	A40T-DTFNL 22	40	50	27	37	18.5	300	36.0	-13	-6	✓	2.58	GI025 DT22

GI024	TN.. 1604..
GI025	TN.. 2204..

DT22	DCS 12	3.9	DTS 315-04	US 2002-T15P	FLAG T15P/3,5
DTI16	DCS 09	1.7	DTS 316-01	US 2004-T09P	FLAG T09P

PTFN(RL) INT

P
M
K
N
S
H

PRAMET

P



Internal Lever Lock Holder with 90° Cutting Angle for TN.. Inserts

Internal Right/Left hand lever lock boring bar, through coolant available, 90° cutting angle for TN.. inserts. For internal taper and longitudinal turning with shoulder and chamfer turning. Body treated for longer tool life.

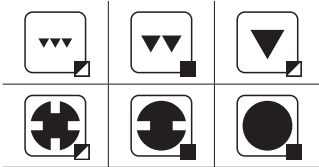
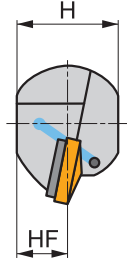
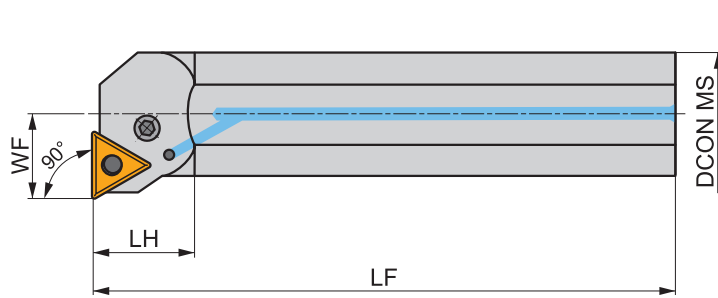
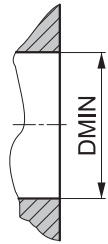
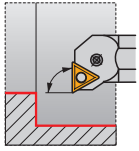

Product	DCON MS	DMIN	WF	H	B	LF	LAMS	GAMO				
	(mm)	(mm)	(mm)	(mm)	(mm)	(mm)	(°)	(°)				
R A25R-PTFNR 16	25	31	17	23	-	200	-13	-6	-	0.71	GI024	PT04
	A32S-PTFNR 16	32	39	22	30	-	250	-12	✓	1.45	GI024	PT01
L A25R-PTFNL 16	25	31	17	23	-	200	-13	-6	-	0.71	GI024	PT04

GI024	TN.. 1604..

PT01	PTS 416	CL 009	CS 606	2.0	M 6x1	16.7	TR 09	MT 04	HXX 2.5
PT04	-	CL 216	CS 605	1.4	M 5x1	12	-	-	HXX 2

C.-DTFN(RL) INT

P
M
K
N
S
H

PRAMET

D



Internal PSC Quick Change Tool, Double Clamp, 91° Cutting Angle, TN.. Inserts

Internal Right/Left hand double clamp tool, through coolant, with 91° cutting angle for a wide range of internal turning applications with TN.. inserts. Polygon Shank Coupling. Body treated for longer tool life.

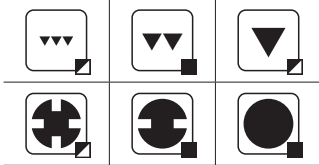
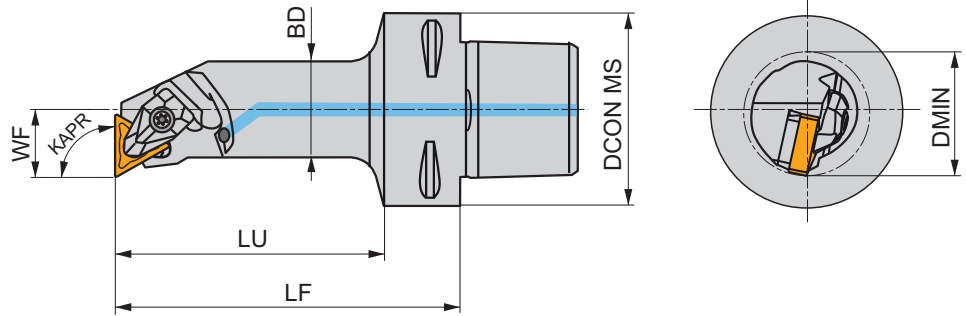
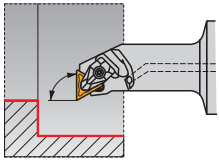

Product	DCON MS (mm)	DMIN (mm)	WF (mm)	LF (mm)	LU (mm)	BD (mm)	KAPR (°)	LAMS (°)	GAMO (°)				
R C4-DTFNR-17090-16	40	32	17	90	68	25	91	-12	-6	✓	0.51	G1024	DTI16

	G1024		TN.. 1604..
--	-------	--	-------------

	DTI16		DCS 09		1.7		DTS 316-01		US 2004-T09P		FLAG T09P
--	-------	--	--------	--	-----	--	------------	--	--------------	--	-----------

DVJN(RL) EXT



PRAMET

D



External Double Clamp Holder with 93° Cutting Angle for VN.. Inserts

External Right/Left hand double clamp tool holder with 93° cutting angle. Suited for longitudinal turning with shoulder, copy and taper turning and chamfering with negative VN.. inserts. Body treated for longer tool life.

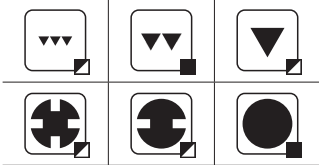
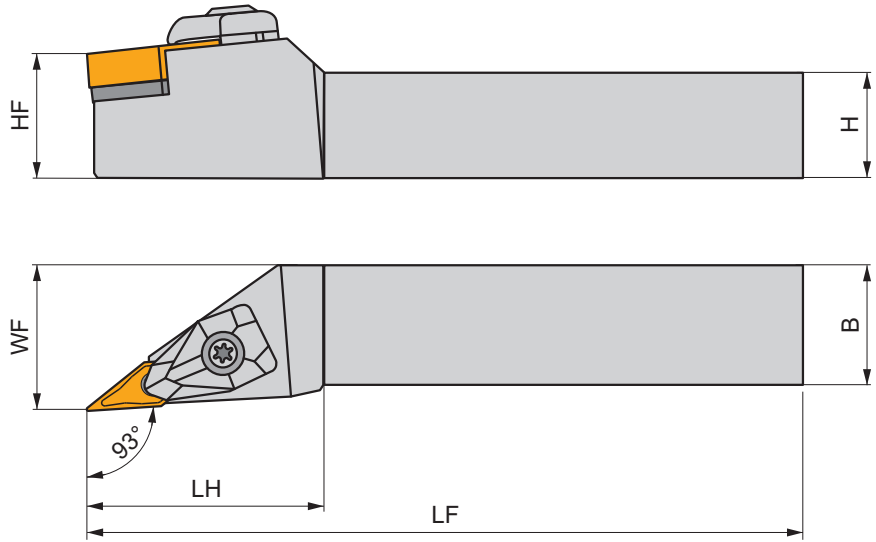
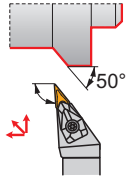

Product	H (mm)	B (mm)	HF (mm)	WF (mm)	LF (mm)	LH (mm)	LAMS (°)	GAMO (°)	kg	GI048	DV16
R DVJNR 2020 K 16	20	20	20	25	125	46.4	-13	-4	0.43	GI048	DV16
DVJNR 2525 M 16	25	25	25	32	150	46.4	-13	-4	0.74	GI048	DV16
DVJNR 3225 P 16	32	25	32	32	170	46.4	-13	-4	1.05	GI048	DV16
L DVJNL 2020 K 16	20	20	20	25	125	46.4	-13	-4	0.43	GI048	DV16
DVJNL 2525 M 16	25	25	25	32	150	46.4	-13	-4	0.75	GI048	DV16
DVJNL 3225 P 16	32	25	32	32	170	46.4	-13	-4	1.06	GI048	DV16

GI048	VN.. 1604..
-------	-------------

DV16	DCS 16V	3.0	DVS 269-01	US 2009-T15P	FLAGT15P/3,5
------	---------	-----	------------	--------------	--------------

DVPN(RL) EXT

P
M
K
N
S
H

PRAMET

D



External Double Clamp Holder with 117.5° Cutting Angle for VN.. Inserts

External Right/Left hand double clamp tool holder with 117.5° cutting angle. Suited for longitudinal and face turning with shoulder, copy and taper turning and chamfering with negative VN.. inserts. Body treated for longer tool life.

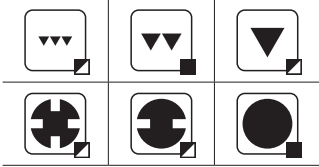
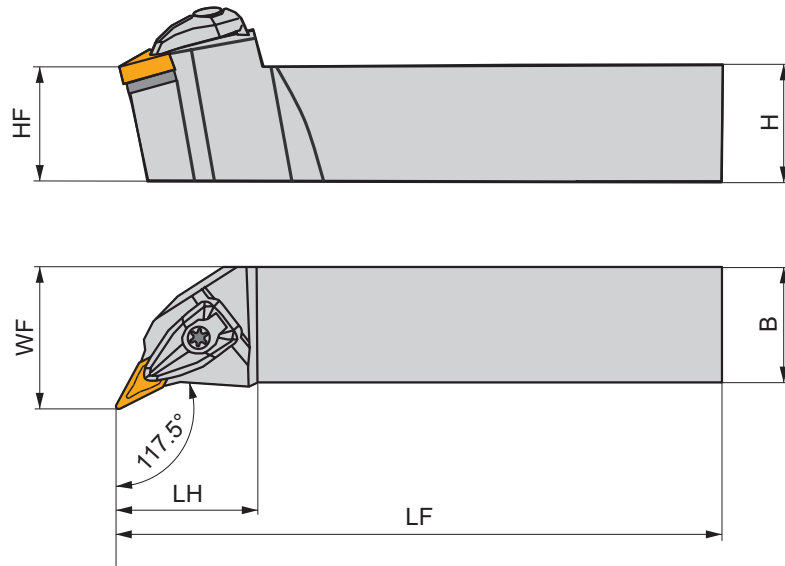
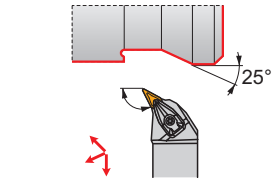

Product	H (mm)	B (mm)	HF (mm)	WF (mm)	LF (mm)	LH (mm)	LAMS (°)	GAMO (°)	kg		
R DVPNR 2525 M 16	25	25	25	32	150	39.2	-13	-4	0.75	G1048	DV16
L DVPNL 2525 M 16	25	25	25	32	150	39.2	-13	-4	0.74	G1048	DV16

	G1048		VN.. 1604..
--	-------	--	-------------

	DV16		DCS 16V		3.0		DVS 269-01		US 2009-T15P		FLAG T15P/3,5
--	------	--	---------	--	-----	--	------------	--	--------------	--	---------------

MVJN(RL) EXT

P
M
K
N
S
H

PRAMET

M



External Multi-Clamp Holder with 93° Cutting Angle for VN.. Inserts

External Right/Left hand multi-clamp turning holder with 93° cutting angle. Suited for longitudinal turning with shoulder, copy turning up to 50°, taper and chamfer turning with negative VN.. insert. Body treated for longer tool life.

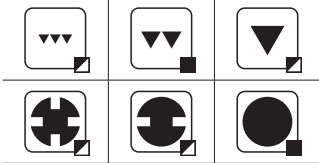
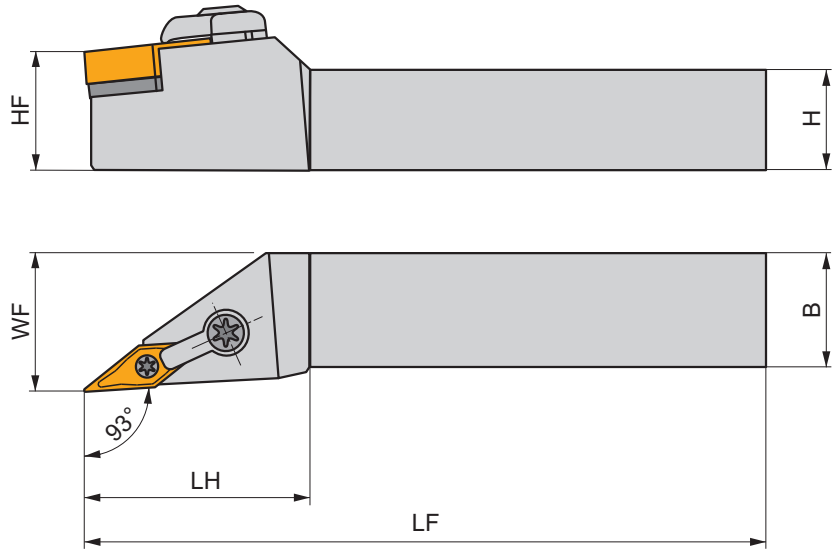
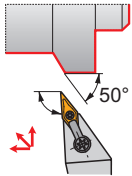

Product	H	B	HF	WF	LF	LH	LAMS	GAMO	kg			
	(mm)	(mm)	(mm)	(mm)	(mm)	(mm)	(°)	(°)				
R	MVJNR 2020 K 16-A	20	20	20	25	125	41.0	-4.5	-13.5	0.40	G1048	MV2
	MVJNR 2525 M 16-A	25	25	25	32	150	41.0	-4.5	-13.5	0.70	G1048	MV2
	MVJNR 3225 P 16-A	32	25	32	32	170	41.0	-4.5	-13.5	0.98	G1048	MV2
L	MVJNL 2020 K 16-A	20	20	20	25	125	41.0	-4.5	-13.5	0.40	G1048	MV2
	MVJNL 2525 M 16-A	25	25	25	32	150	41.0	-4.5	-13.5	0.70	G1048	MV2
	MVJNL 3225 P 16-A	32	25	32	32	170	41.0	-4.5	-13.5	0.99	G1048	MV2

G1048	VN.. 1604..

MV2	UPC 22	MVN 160316	UP 0909-T09P	2.0	PS 6026-T09P	2.0	FLAG T09P

C.-DVJN(RL) EXT

P
M
K
N
S
H

PRAMET

D



External PSC Quick Change Tool, Double Clamp, 93° Cutting Angle, VN.. Inserts

External Right/Left hand double clamp tool, through coolant, with 93° cutting angle for longitudinal turning with shoulder, copy and taper turning and chamfering with negative VN.. inserts. Polygon Shank Coupling. Body treated for longer tool life.

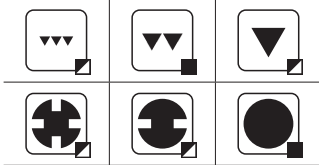
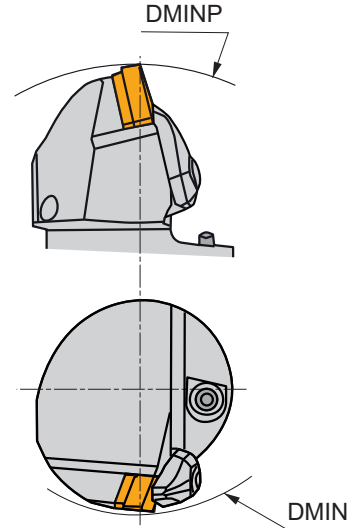
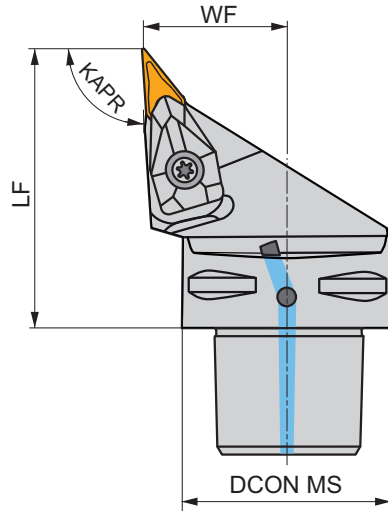
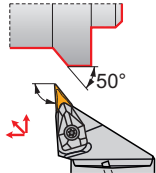

Product	DCON MS	DMIN	DMINP	WF	LF	KAPR	LAMS	GAMO					
	(mm)	(mm)	(mm)	(mm)	(mm)	(°)	(°)	(°)					
R	C4-DVJNR-27062-16	40	60	152	27	62	93	-13	-4	✓	0.45	GI048	C-DV16-1
	C5-DVJNR-35065-16	50	65	170	35	65	93	-13	-4	✓	0.47	GI048	C-DV16-2
	C6-DVJNR-45065-16	63	81	190	45	65	93	-13	-4	✓	1.13	GI048	C-DV16-2
L	C4-DVJNL-27062-16	40	60	152	27	62	93	-13	-4	✓	0.45	GI048	C-DV16-1
	C5-DVJNL-35065-16	50	65	170	35	65	93	-13	-4	✓	0.71	GI048	C-DV16-2
	C6-DVJNL-45065-16	63	81	190	45	65	93	-13	-4	✓	1.13	GI048	C-DV16-2

	GI048		VN.. 1604..
--	-------	--	-------------

C-DV16-1	DCS 16V	3.0	DVS 269-01	US 2009-T15P	FLAG T15P/3,5
C-DV16-2	DCS 16V	3.0	DVS 269-01	US 2009-T15P	FLAG T15P/3,5

DVUN(RL) INT

P
M
K
N
S
H

PRAMET

D



Internal Double Clamp Boring Bar with 93° Cutting Angle for VN.. Inserts

Internal Right/Left hand double clamp boring bar, through coolant, with 93° cutting angle for VN.. inserts. Suited for internal taper, longitudinal turning with shoulder, copying and chamfer turning. Body treated for longer tool life.

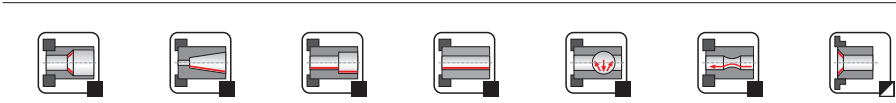
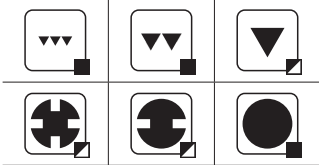
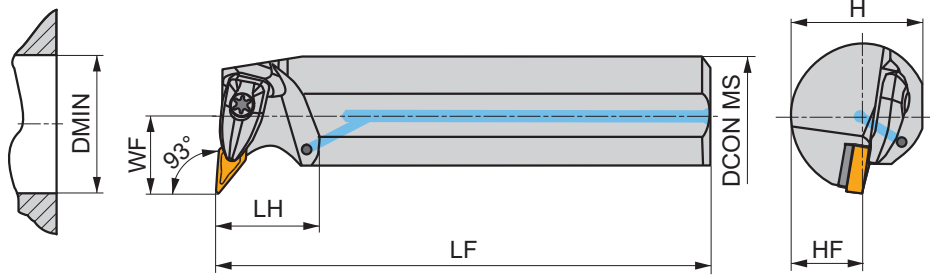
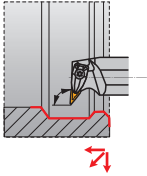

Product	DCON MS (mm)	DMIN (mm)	WF (mm)	H (mm)	HF (mm)	LF (mm)	LH (mm)	LAMS (°)	GAMO (°)		kg		
R A40T-DVUNR 16	40	50	27	37	18.5	300	36.0	-9	-6	✓	2.59	GI048	DV16
L A40T-DVUNL 16	40	50	27	37	18.5	300	36.0	-9	-6	✓	2.58	GI048	DV16

	GI048		VN.. 1604..
--	-------	--	-------------

	DV16		DCS 16V		3.0		DVS 269-01		US 2009-T15P		FLAG T15P/3,5
--	------	--	---------	--	-----	--	------------	--	--------------	--	---------------

DWLN(RL) EXT



PRAMET







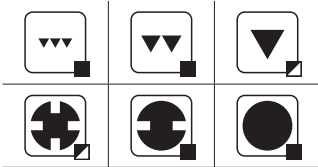
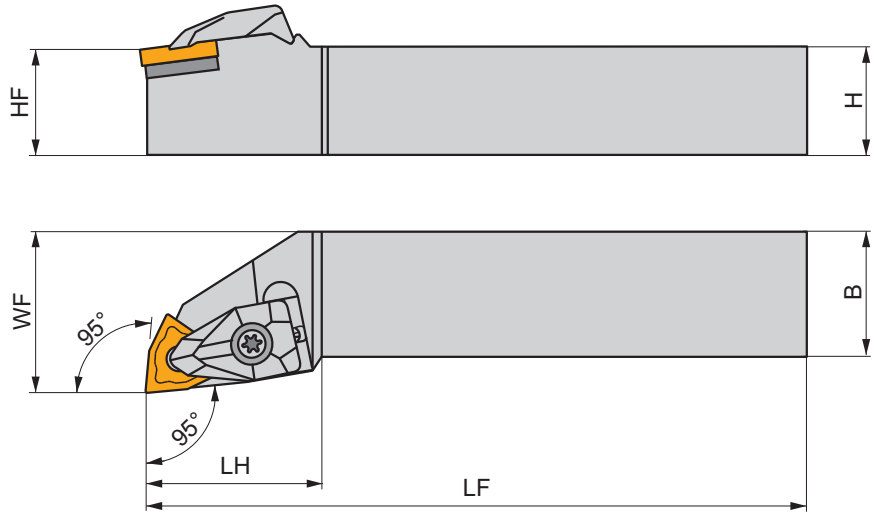
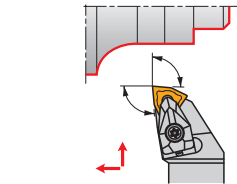

External Double Clamp Holder with 95° Cutting Angle for WN.. Inserts



External Right/Left hand double clamp turning holder with 95° cutting angle. Suited for longitudinal turning with shoulder, face, taper and chamfer turning with negative WN.. inserts. Body treated for longer tool life.



	Product	H	B	HF	WF	LF	LH	LAMS	GAMO	kg			
		(mm)	(mm)	(mm)	(mm)	(mm)	(mm)	(°)	(°)				
R	DWLN R 1616 H 06	16	16	16	20	100	26.4	-6	-6	0.22	GI028	DW06	-
	DWLN R 2020 K 06	20	20	20	25	125	27.1	-6	-6	0.41	GI028	DW06	-
	DWLN R 2525 M 06	25	25	25	32	150	27.1	-6	-6	0.75	GI028	DW06	-
	DWLN R 2020 K 08	20	20	20	25	125	34.3	-6	-6	0.43	GI072	DW08	AT004
	DWLN R 2525 M 08	25	25	25	32	150	35.0	-6	-6	0.75	GI072	DW08	AT004
	DWLN R 3225 P 08	32	25	32	32	170	35.0	-6	-6	1.01	GI072	DW08	AT004
	DWLN R 3225 P 10	32	25	32	32	170	38.0	-6	-6	1.06	GI166	DW10	-
	DWLN R 3232 P 13	32	32	32	40	170	40.0	-6	-6	1.40	GI167	DW13	-
L	DWLN L 1616 H 06	16	16	16	20	100	26.4	-6	-6	0.22	GI028	DW06	-
	DWLN L 2020 K 06	20	20	20	25	125	27.1	-6	-6	0.41	GI028	DW06	-
	DWLN L 2525 M 06	25	25	25	32	150	27.1	-6	-6	0.76	GI028	DW06	-
	DWLN L 2020 K 08	20	20	20	25	125	34.3	-6	-6	0.43	GI072	DW08	AT004
	DWLN L 2525 M 08	25	25	25	32	150	35.0	-6	-6	0.74	GI072	DW08	AT004
	DWLN L 3225 P 08	32	25	32	32	170	35.0	-6	-6	1.10	GI072	DW08	AT004
	DWLN L 3225 P 10	32	25	32	32	170	38.0	-6	-6	1.14	GI166	DW10	-
	DWLN L 3232 P 13	32	32	32	40	170	40.0	-6	-6	1.43	GI167	DW13	-
DWLN L 4040 S 13	40	40	40	50	250	41.0	-6	-6	3.17	GI167	DW13	-	

GI028	WN.. 0604..
GI072	WN.. 0804..
GI166	WN.. 1006..
GI167	WN.. 1306..

						
DW06	DCS 09	1.7	DWS 328-01	US 2004-T09P	FLAG T09P	-
DW08	DCS 12	3.9	DWS 331-12	US 2002-T15P	FLAG T15P/3,5	-
DW10	DCS 16	6.4	DWN 100612	US 5018-T20P	-	LKT20P
DW13	DCS 19	6.4	DWN 130612	US 6013-T20P	-	LKT20P

		
AT004a	CER WN.N 0804..	DCS 12C4
AT004b	CER WN.A 0804..	DCS 12C2

MWLN(RL) EXT

P
M
K
N
S
H

PRAMET

M



External Multi-Clamp Holder with 95° Cutting Angle for WN.. Inserts

External Right/Left hand multi-clamp turning holder with 95° cutting angle. Suited for longitudinal turning with shoulder, face, taper and chamfer turning with negative WN.. inserts. Body treated for longer tool life.

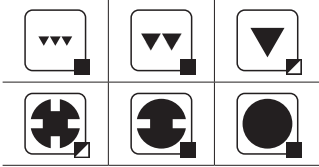
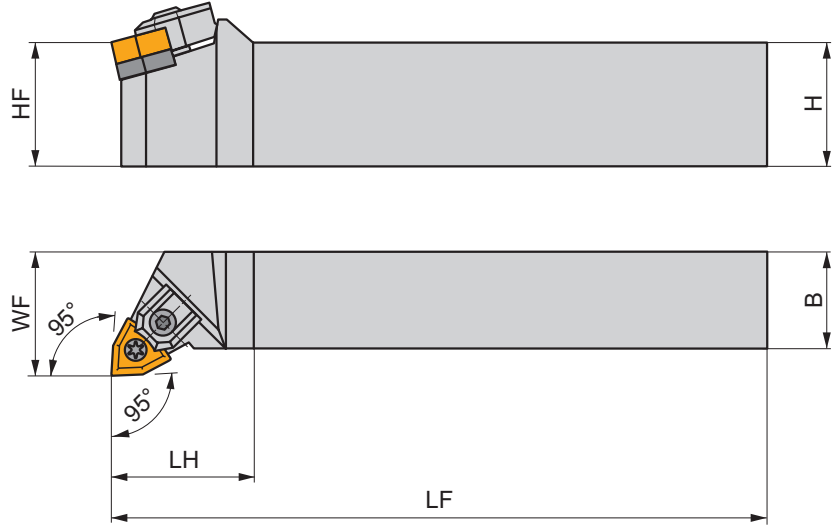
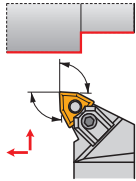

Product	H	B	HF	WF	LF	LH	LAMS	GAMO	kg		
	(mm)	(mm)	(mm)	(mm)	(mm)	(mm)	(°)	(°)			
R MWLNR 2525 M 08	25	25	25	32	150	34.0	-6	-6	0.73	G1072	MW02
MWLNR 3225 P 08	32	25	32	32	170	34.0	-6	-6	1.09	G1072	MW02
MWLNR 4040 S 08	40	40	40	50	250	45.0	-6	-6	3.14	G1072	MW02
L MWLNL 2525 M 08	25	25	25	32	150	34.0	-6	-6	0.78	G1072	MW02
MWLNL 3225 P 08	32	25	32	32	170	34.0	-6	-6	1.02	G1072	MW02
MWLNL 4040 S 08	40	40	40	50	250	45.0	-6	-6	3.14	G1072	MW02

G1072 WN.. 0804..

MW02 UE 11 4.0 MWS 433 UC 61 HS 94 HXK 5

PWLN(RL) EXT



PRAMET



External Lever Lock Holder with 95° Cutting Angle for WN.. Inserts

External Right/Left hand lever lock turning holder with 95° cutting angle. Suited for longitudinal turning with shoulder, face, taper and chamfer turning with negative WN.. inserts. Body treated for longer tool life.

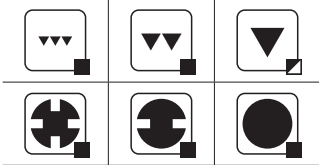
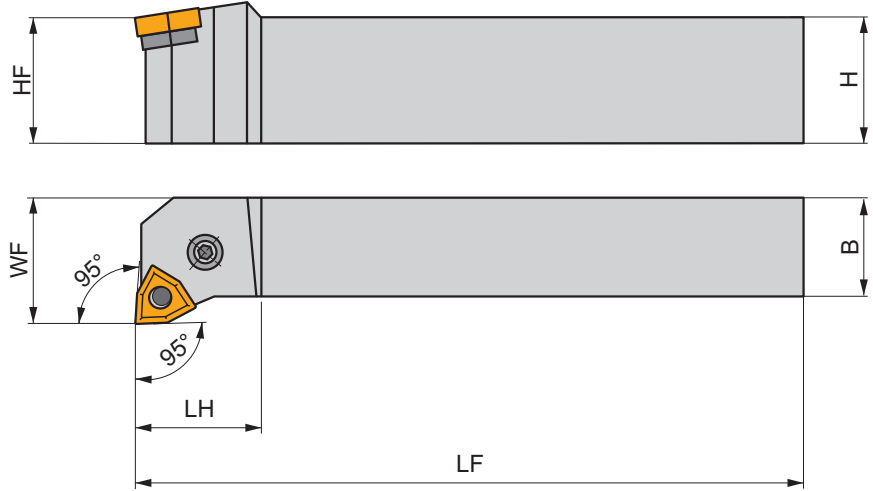
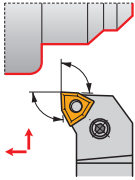

Product	H (mm)	B (mm)	HF (mm)	WF (mm)	LF (mm)	LH (mm)	LAMS (°)	GAMO (°)	kg			
R	PWLN R 1616 H 0604	16	16	16	20	100	22.0	-6	-6	0.22	G1028	PW01
	PWLN R 2020 K 0604	20	20	20	25	125	22.0	-6	-6	0.40	G1028	PW01
	PWLN R 2525 M 0604	25	25	25	32	150	25.0	-6	-6	0.75	G1028	PW01
	PWLN R 2020 K 08	20	20	20	25	125	28.0	-6	-6	0.41	G1072	PW02
	PWLN R 2525 M 08	25	25	25	32	150	28.0	-6	-6	0.76	G1072	PW02
	PWLN R 3225 P 08	32	25	32	32	170	34.0	-6	-6	1.05	G1072	PW02
L	PWLN L 1616 H 0604	16	16	16	20	100	22.0	-6	-6	0.21	G1028	PW01
	PWLN L 2020 K 0604	20	20	20	25	125	22.0	-6	-6	0.41	G1028	PW01
	PWLN L 2525 M 0604	25	25	25	32	150	25.0	-6	-6	0.75	G1028	PW01
	PWLN L 2020 K 08	20	20	20	25	125	28.0	-6	-6	0.40	G1072	PW02
	PWLN L 2525 M 08	25	25	25	32	150	28.0	-6	-6	0.74	G1072	PW02
	PWLN L 3225 P 08	32	25	32	32	170	34.0	-6	-6	1.05	G1072	PW02

G1028	WN.. 0604..
G1072	WN.. 0804..

PW01	PWS 007	CL 009	CS 606	2.0	M 6x1	16.7	TR 09	MT 04	HXK 2.5
PW02	PWS 008	CL 012	CS 608	3.0	M 8x1	20.7	TR 12	MT 05	HXK 3

C.-DWLN(RL) EXT

P
M
K
N
S
H

PRAMET

D



External PSC Quick Change Tool, Double Clamp, 95° Cutting Angle, WN.. Inserts

External Right/Left hand double clamp tool, through coolant, with 95° cutting angle for face and longitudinal turning with shoulder, taper and chamfering with negative WN.. inserts. Polygon Shank Coupling. Body treated for longer tool life.

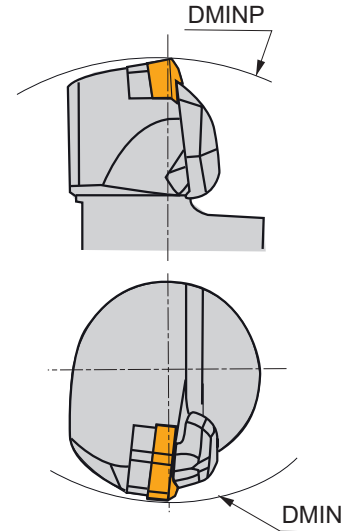
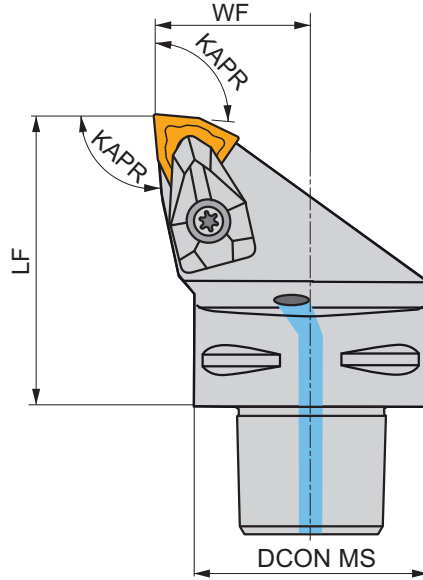
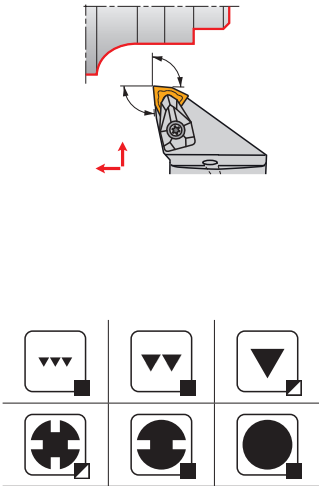

Product	DCON MS	DMIN	DMINP	WF	LF	KAPR	LAMS	GAMO		kg			
	(mm)	(mm)	(mm)	(mm)	(mm)	(°)	(°)	(°)					
R C4-DWLN-27050-06	40	60	140	27	50	95	-6	-6	✓	0.42	GI028	C-DW06	-
C4-DWLN-27050-08	40	110	140	27	50	95	-6	-6	✓	0.42	GI028	C-DW08-1	AT004
C5-DWLN-35060-08	50	110	165	35	60	95	-6	-6	✓	0.74	GI072	C-DW08-2	AT004
C6-DWLN-45065-08	63	110	190	45	65	95	-6	-6	✓	1.34	GI072	C-DW08-2	AT004
L C4-DWLN-27050-06	40	60	140	27	50	95	-6	-6	✓	0.43	GI028	C-DW06	-
C4-DWLN-27050-08	40	110	140	27	50	95	-6	-6	✓	0.42	GI072	C-DW08-1	AT004
C5-DWLN-35060-08	50	110	165	35	60	95	-6	-6	✓	0.76	GI072	C-DW08-2	AT004
C6-DWLN-45065-08	63	110	190	45	65	95	-6	-6	✓	1.34	GI072	C-DW08-2	AT004

GI028	WN.. 0604..
GI072	WN.. 0804..

C-DW06	DCS 09	1.7	DWS 328-01	US 2004-T09P	FLAG T09P	CN 034-01
C-DW08-1	DCS 12	3.9	DWS 331-12	US 2002-T15P	FLAG T15P/3,5	CN 034-01
C-DW08-2	DCS 12	3.9	DWS 331-12	US 2002-T15P	FLAG T15P/3,5	CN 045-01

AT004a	CER WN.N 0804..	DCS 12C4
AT004b	CER WN.A 0804..	DCS 12C2

DWLN(RL) INT

P M K N S H

PRAMET

D



Internal Double Clamp Boring Bar with 95° Cutting Angle for WN.. Inserts

Internal Right/Left hand double clamp boring bar, through coolant, 95° cutting angle for negative WN.. inserts. For internal taper, longitudinal turning with shoulder and chamfer turning. Body treated for longer tool life.

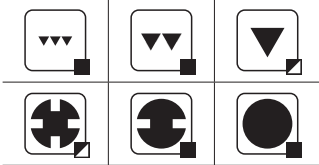
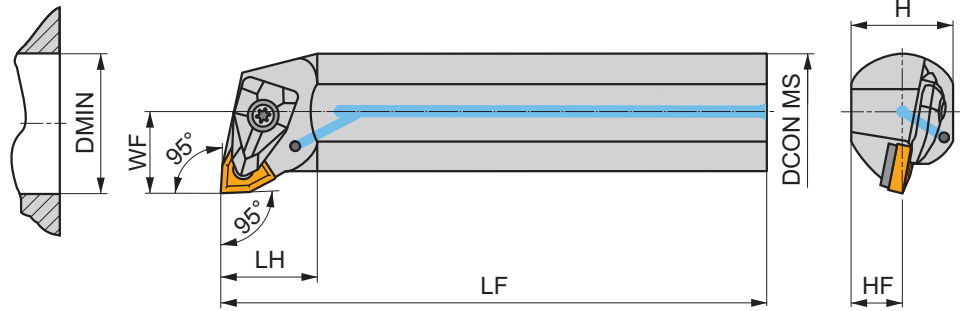
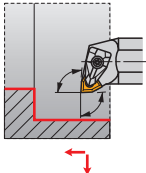

Product	DCON MS	DMIN	WF	H	HF	LF	LH	LAMS	GAMO					
	(mm)	(mm)	(mm)	(mm)	(mm)	(mm)	(mm)	(°)	(°)					
R	A25T-DWLN R 06	25	32	17	23	11.5	300	31.0	-14	-6	✓	0.97	G1028	DW06
	A25T-DWLN R 08	25	33	17	23	11.5	300	31.0	-12	-6	✓	0.98	G1072	DW108
	A32T-DWLN R 08	32	40	22	30	15	300	33.0	-10	-6	✓	1.70	G1072	DW108
	A40T-DWLN R 08	40	50	27	37	18.5	300	36.0	-13	-6	✓	2.59	G1072	DW08
	A50U-DWLN R 08	50	63	35	47	23.5	350	39.0	-11	-6	✓	5.24	G1072	DW08
L	A25T-DWLN L 06	25	32	17	23	11.5	300	31.0	-14	-6	✓	0.97	G1028	DW06
	A25T-DWLN L 08	25	33	17	23	11.5	300	31.0	-12	-6	✓	0.98	G1072	DW108
	A32T-DWLN L 08	32	40	22	30	15	300	33.0	-10	-6	✓	1.70	G1072	DW108
	A40T-DWLN L 08	40	50	27	37	18.5	300	36.0	-13	-6	✓	2.59	G1072	DW08
	A50U-DWLN L 08	50	63	35	47	23.5	350	39.0	-11	-6	✓	5.25	G1072	DW08

G1028	WN.. 0604..
G1072	WN.. 0804..

DW06	DCS 09	1.7	DWS 328-01	US 2004-T09P	FLAG T09P
DW08	DCS 12	3.9	DWS 331-12	US 2002-T15P	FLAG T15P/3,5
DW108	DCS 12	3.9	DWS 328-02	US 2002-T15P	FLAG T15P/3,5

PWLN(RL) INT

P
M
K
N
S
H

PRAMET

P



Internal Lever Lock Boring Bar with 95° Cutting Angle for WN.. Inserts

Internal Right/Left hand lever lock boring bar, through coolant available, 95° cutting angle for WN.. inserts. For internal taper and longitudinal turning with shoulder and chamfer turning. Body treated for longer tool life.

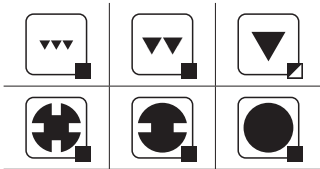
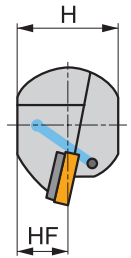
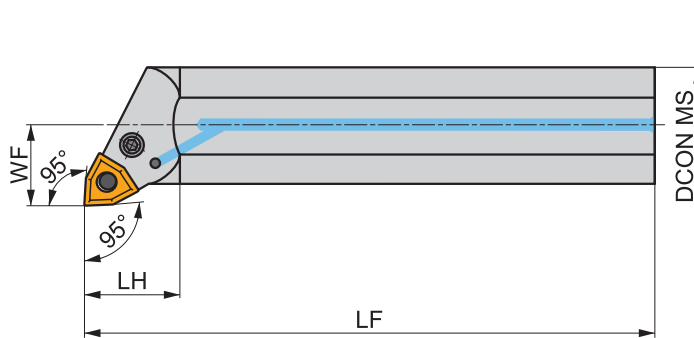
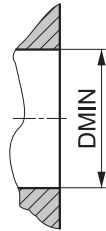
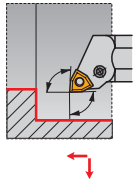

Product	DCON MS	DMIN	WF	H	B	LF	LAMS	GAMO					
	(mm)	(mm)	(mm)	(mm)	(mm)	(mm)	(°)	(°)					
R	A16M-PWLN R 0604	16	20	11	15	-	150	-18	-4	✓	0.24	GI028	PT04
	A20Q-PWLN R 0604	20	27	13	18	-	180	-18	-4	✓	0.36	GI028	PT04
	A25R-PWLN R 0604	25	31	17	23	-	200	-14	-4	✓	0.72	GI028	PW01
	A32S-PWLN R 0604	32	39	22	30	-	250	-12	-4	✓	1.30	GI028	PW01
	A25R-PWLN R 08	25	31	17	23	-	200	-14	-4	✓	0.66	GI072	PC06
	A32S-PWLN R 08	32	39	22	30	-	250	-12	-4	✓	1.46	GI072	PW02
	A40T-PWLN R 08	40	48	27	37	-	300	-12	-4	✓	2.40	GI072	PW02
	A50U-PWLN R 08	50	61	35	47	-	350	-12	-4	✓	4.88	GI072	PW02
L	A16M-PWLN L 0604	16	20	11	15	-	150	-18	-4	✓	0.22	GI028	PT04
	A20Q-PWLN L 0604	20	27	13	18	-	180	-18	-4	✓	0.36	GI028	PT04
	A25R-PWLN L 0604	25	31	17	23	-	200	-14	-4	✓	0.71	GI028	PW01
	A25R-PWLN L 08	25	31	17	23	-	200	-14	-4	✓	0.71	GI072	PC06
	A32S-PWLN L 08	32	39	22	30	-	250	-12	-4	✓	1.43	GI072	PW02
	A40T-PWLN L 08	40	48	27	37	-	300	-12	-4	-	2.70	GI072	PW02
	A50U-PWLN L 08	50	61	35	47	-	350	-12	-4	✓	4.88	GI072	PW02



GI028
GI072



WN.. 0604..
WN.. 0804..

PW01	PWS 007	CL 009	CS 606	2.0	M 6x1	16.7	TR 09	MT 04	HXX 2.5
PW02	PWS 008	CL 012	CS 608	3.0	M 8x1	20.7	TR 12	MT 05	HXX 3
PT04	-	CL 216	CS 605	1.4	M 5x1	12	-	-	HXX 2
PC06	-	CL 212	CS 626	2.0	M 6x1	13.4	-	-	HXX 2.5

C.-DWLN(RL) INT

P
M
K
N
S
H

PRAMET

D



Internal PSC Quick Change Tool, Double Clamp, 95° Cutting Angle, WN.. Inserts

Internal Right/Left hand double clamp tool, through coolant, with 95° cutting angle for internal taper and longitudinal turning with shoulder and chamfering with WN.. inserts. Polygon Shank Coupling. Body treated for longer tool life.

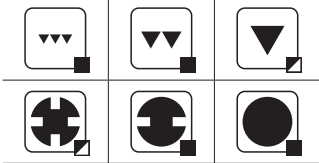
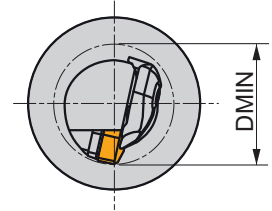
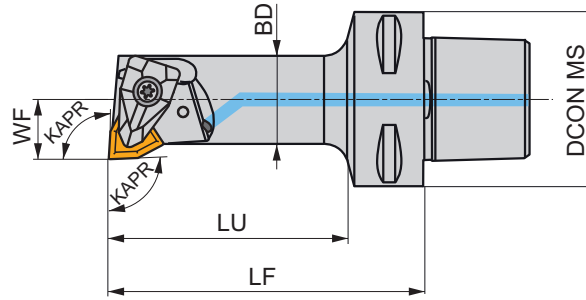
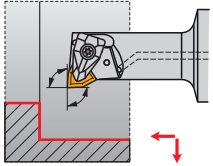

Product	DCON MS	DMIN	WF	LF	LU	BD	KAPR	LAMS	GAMO				
	(mm)	(mm)	(mm)	(mm)	(mm)	(mm)	(°)	(°)	(°)				
R C4-DWLN-13075-06	40	27	13	75	52	20	95	-17	-6	✓	0.42	GI028	DW06
	C4-DWLN-17090-08	40	33	17	90	68	25	95	-12	-6	✓	0.53	GI072
L C4-DWLN-13075-06	40	27	13	75	52	20	95	-17	-6	✓	0.42	GI028	DW06
	C4-DWLN-17090-08	40	33	17	90	68	25	95	-12	-6	✓	0.53	GI072

GI028				WN.. 0604..
GI072				WN.. 0804..

DW06	DCS 09	1.7	DWS 328-01	US 2004-T09P	FLAG T09P
DWI08	DCS 12	3.9	DWS 328-02	US 2002-T15P	FLAG T15P/3,5

P CLAMPING DESIGNATION

TOOLS – NAVIGATOR

ISO TURNING – EXTERNAL

SHORT AND STABLE COMPONENTS (negative inserts)

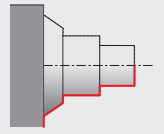

PCBN(RL) EXT 75° CN.. 251	PCKN(RL) EXT 75° CN.. 252	PCLN(RL) EXT 95° CN.. 253	PDJN(RL) EXT 93° DN.. 264
PDNN(RL) EXT 62°30' DN.. 265	PDXN(RL) EXT 98° DN.. 266	PLBN(RL) EXT 75° LN.. 274	PRSN(RL) EXT RN.. 278
PSBN(RL) EXT 75° SN.. 285	PSDNN EXT 45° SN.. 287	PSKN(RL) EXT 75° SN.. 288	PSSN(RL) EXT 45° SN.. 290
PTFN(RL) EXT 90° TN.. 302	PTGN(RL) EXT 90° TN.. 303	PTTN(RL) EXT 60° TN.. 304	PWLN(RL) EXT 95° WN.. 317

D CLAMPING DESIGNATION

TOOLS – NAVIGATOR

ISO TURNING – EXTERNAL

SHORT AND STABLE COMPONENTS (negative inserts)

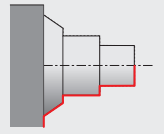

DCBN(RL) EXT 75° CN.. 246	DCKN(RL) EXT 75° CN.. 248	DCLN(RL) EXT 95° CN.. 249	DDJN(RL) EXT 93° DN.. 263
DRSN(RL) EXT RN.. 277	DSBN(RL) EXT 45° SN.. 280	DSDNN EXT 45° SN.. 281	DSKN(RL) EXT 75° SN.. 282
DSSN(RL) EXT 45° SN.. 283	DTFN(RL) EXT 90° TN.. 299	DTGN(RL) EXT 90° TN.. 300	DVJN(RL) EXT 93° VN.. 309

M CLAMPING DESIGNATION

DVPN(RL) EXT 62°30' VN.. 310	MTJN(RL) EXT 93° TN.. 301	MVJN(RL) EXT 93° VN.. 311	MWLN(RL) EXT 95° WN.. 316
DWLN(RL) EXT 95° WN.. 314			

KHP / DKH

CLAMPING DESIGNATION

TOOLS – NAVIGATOR

ISO TURNING – HEAVY ROUGHING – EXTERNAL HEAD (KH)

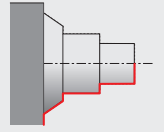

KHP-CBNR 75°
 CN..

 256

KHP-CBNL 75°
 CN..

 256

KHP-CLNR/L 95°
 CN..

 257

KHP-LBNR 75°
 LN..

 275

KHP-LBNL 75°
 LN..

 275

KHP-SBNR 75°
 SN..

 295

KHP-SBNL 75°
 SN..

 295

KHP-SSNR/L 45°
 SN..

 296

DKH(RL)

 258, 276, 297

P CLAMPING DESIGNATION TOOLS – NAVIGATOR

ISO TURNING – INTERNAL
 SHORT AND STABLE COMPONENTS (negative inserts)

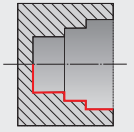

<p>PCLN(RL) INT 95°</p> <p>CN..</p> <p>260</p>	<p>PDUN(RL) INT 93°</p> <p>DN..</p> <p>271</p>	<p>PSKN(RL) INT 93°</p> <p>SN..</p> <p>298</p>	<p>PTFN(RL) INT 90°</p> <p>TN..</p> <p>307</p>
---	---	---	---

PWLN(RL) INT 95°

WN..

320

D CLAMPING DESIGNATION TOOLS – NAVIGATOR

ISO TURNING – INTERNAL
 SHORT AND STABLE COMPONENTS (negative inserts)

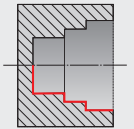

<p>DCLN(RL) INT 95°</p> <p>CN..</p> <p>259</p>	<p>DDUN(RL) INT 93°</p> <p>DN..</p> <p>270</p>	<p>DTFN(RL) INT 90°</p> <p>TN..</p> <p>306</p>	<p>DVUN(RL) INT</p> <p>VN..</p> <p>313</p>
---	---	---	---

DWLN(RL) INT 95°

WN..

319

D CLAMPING DESIGNATION

TOOLS – NAVIGATOR

ISO TURNING – EXTERNAL PSC

SHORT AND STABLE COMPONENTS (negative inserts)

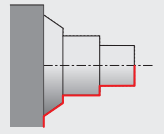

C.-DCLN(RL) EXT 95°
 CN..

 254

C.-DDJN(RL) EXT 93°
 DN..

 267

C.-DDNNN EXT 62.5°
 DN..

 268

C.-DDUN(RL) EXT 93°
 DN..

 269

C.-DRSN(RL) EXT
 RN..

 279

C.-DSDNN EXT 45°
 SN..

 291

C.-DSKN(RL) EXT 75°
 SN..

 292

C.-DSRN(RL) EXT 75°
 SN..

 293

C.-DSSN(RL) EXT 45°
 SN..

 294

C.-DTJN(RL) EXT 93°
 TN..

 305

C.-DVJN(RL) EXT 93°
 VN..

 312

C.-DWLN(RL) EXT 95°
 WN..

 318

ISO TURNING – INTERNAL PSC

SHORT AND STABLE COMPONENTS (negative inserts)

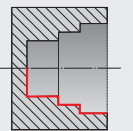

C.-DCLN(RL) INT 95°
 CN..

 262

C.-DDUN(RL) INT 93°
 DN..

 272

C.-DTFN(RL) INT 91°
 TN..

 308

C.-DWLN(RL) INT 95°
 WN..

 321



OTHER CARBIDE & CERMET INSERTS

KNUX



	W1 (mm)	L (mm)	S (mm)
1604	9.525	19.50	4.76

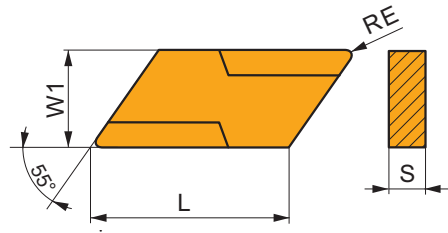

Suitability and starting values for cutting speed (vc), feed (f) and depth of cut (ap). Refer to our Machining Calculator app for further calculations.

Product	RE (mm)	P			M			K			N			S			H		
		vc (m/min)	f (mm/rev)	ap (mm)	vc (m/min)	f (mm/rev)	ap (mm)	vc (m/min)	f (mm/rev)	ap (mm)	vc (m/min)	f (mm/rev)	ap (mm)	vc (m/min)	f (mm/rev)	ap (mm)	vc (m/min)	f (mm/rev)	ap (mm)

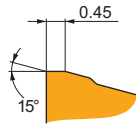

L-22 geometry with left-handed design for finish to semi-rough machining, and continuous cuts.

KNUX 160405L-22:T5315	● 0.5	✓ 190	0.25	2.7	–	–	–	✓ 180	0.25	2.7	–	–	–	–	–	–	–	–	–
KNUX 160405L-22:T7325	● 0.5	✓ 130	0.25	2.7	✓ 100	0.25	2.7	–	–	–	–	–	–	–	–	–	–	–	–
KNUX 160405L-22:T7335	● 0.5	✓ 125	0.25	2.7	✓ 95	0.25	2.7	–	–	–	–	–	–	–	–	–	–	–	–
KNUX 160405L-22:T9325	● 0.5	✓ 155	0.25	2.7	✓ 90	0.25	2.7	✓ 145	0.25	2.7	–	–	–	–	–	–	–	–	–
KNUX 160405L-22:T9335	● 0.5	✓ 135	0.25	2.7	✓ 80	0.25	2.7	–	–	–	–	–	–	–	–	–	–	–	–
KNUX 160410L-22:T9335	● 1.0	✓ 155	0.32	2.7	✓ 90	0.29	2.7	–	–	–	–	–	–	–	–	–	–	–	–

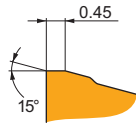

R-22 geometry with right-handed design for finish to semi-rough machining, and continuous cuts.

KNUX 160405R-22:T5315	● 0.5	✓ 190	0.25	2.7	–	–	–	✓ 180	0.25	2.7	–	–	–	–	–	–	–	–	–
KNUX 160405R-22:T7325	● 0.5	✓ 130	0.25	2.7	✓ 100	0.25	2.7	–	–	–	–	–	–	–	–	–	–	–	–
KNUX 160405R-22:T7335	● 0.5	✓ 125	0.25	2.7	✓ 95	0.25	2.7	–	–	–	–	–	–	–	–	–	–	–	–
KNUX 160405R-22:T9325	● 0.5	✓ 155	0.25	2.7	✓ 90	0.25	2.7	✓ 145	0.25	2.7	–	–	–	–	–	–	–	–	–
KNUX 160405R-22:T9335	● 0.5	✓ 135	0.25	2.7	✓ 80	0.25	2.7	–	–	–	–	–	–	–	–	–	–	–	–
KNUX 160410R-22:T9335	● 1.0	✓ 155	0.32	2.7	✓ 90	0.29	2.7	–	–	–	–	–	–	–	–	–	–	–	–

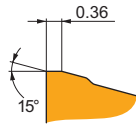

L-32 geometry with left-handed design for finish to semi-rough machining, and continuous cuts.

KNUX 160405L-32:T5315	● 0.5	✓ 190	0.25	2.7	–	–	–	✓ 180	0.25	2.7	–	–	–	–	–	–	–	–	–
KNUX 160405L-32:T7325	● 0.5	✓ 130	0.25	2.7	✓ 100	0.25	2.7	–	–	–	–	–	–	–	–	–	–	–	–
KNUX 160405L-32:T7335	● 0.5	✓ 125	0.25	2.7	✓ 95	0.25	2.7	–	–	–	–	–	–	–	–	–	–	–	–
KNUX 160405L-32:T9325	● 0.5	✓ 155	0.25	2.7	✓ 90	0.25	2.7	✓ 145	0.25	2.7	–	–	–	–	–	–	–	–	–
KNUX 160405L-32:T9335	● 0.5	✓ 135	0.25	2.7	✓ 80	0.25	2.7	–	–	–	–	–	–	–	–	–	–	–	–
KNUX 160410L-32:T9325	● 1.0	✓ 175	0.32	2.7	✓ 105	0.29	2.7	✓ 165	0.32	2.7	–	–	–	–	–	–	–	–	–
KNUX 160410L-32:T9335	● 1.0	✓ 155	0.32	2.7	✓ 90	0.29	2.7	–	–	–	–	–	–	–	–	–	–	–	–

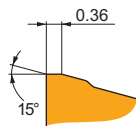

R-32 geometry with right-handed design for finish to semi-rough machining, and continuous cuts.

KNUX 160405R-32:T5315	● 0.5	✓ 190	0.25	2.7	–	–	–	✓ 180	0.25	2.7	–	–	–	–	–	–	–	–	–
KNUX 160405R-32:T7325	● 0.5	✓ 130	0.25	2.7	✓ 100	0.25	2.7	–	–	–	–	–	–	–	–	–	–	–	–
KNUX 160405R-32:T7335	● 0.5	✓ 125	0.25	2.7	✓ 95	0.25	2.7	–	–	–	–	–	–	–	–	–	–	–	–
KNUX 160405R-32:T9325	● 0.5	✓ 155	0.25	2.7	✓ 90	0.25	2.7	✓ 145	0.25	2.7	–	–	–	–	–	–	–	–	–
KNUX 160405R-32:T9335	● 0.5	✓ 135	0.25	2.7	✓ 80	0.25	2.7	–	–	–	–	–	–	–	–	–	–	–	–
KNUX 160410R-32:T9325	● 1.0	✓ 175	0.32	2.7	✓ 105	0.29	2.7	✓ 165	0.32	2.7	–	–	–	–	–	–	–	–	–
KNUX 160410R-32:T9335	● 1.0	✓ 155	0.32	2.7	✓ 90	0.29	2.7	–	–	–	–	–	–	–	–	–	–	–	–

Suitability and starting values for cutting speed (vc), feed (f) and depth of cut (ap). Refer to our Machining Calculator app for further calculations.

Product	RE (mm)	P			M			K			N			S			H		
		vc (m/min)	f (mm/rev)	ap (mm)	vc (m/min)	f (mm/rev)	ap (mm)	vc (m/min)	f (mm/rev)	ap (mm)	vc (m/min)	f (mm/rev)	ap (mm)	vc (m/min)	f (mm/rev)	ap (mm)	vc (m/min)	f (mm/rev)	ap (mm)

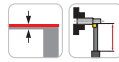
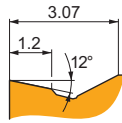

ER-72 geometry with right-handed design for fine to finish machining, and continuous cuts.

KNUX 160405ER-72:T5315	● 0.5	250	0.20	2.0	–	–	–	235	0.20	2.0	–	–	–	–	–	–	–	–	–
KNUX 160405ER-72:T9325	● 0.5	215	0.20	2.0	125	0.18	2.0	200	0.20	2.0	–	–	–	45	0.16	1.6	–	–	–
KNUX 160405ER-72:T9335	● 0.5	185	0.20	2.0	110	0.18	2.0	–	–	–	–	–	–	40	0.16	1.6	–	–	–

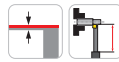
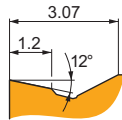
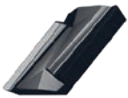

EL-72 geometry with left-handed design for fine to finish machining, and continuous cuts.

KNUX 160405EL-72:T5315	● 0.5	250	0.20	2.0	–	–	–	235	0.20	2.0	–	–	–	–	–	–	–	–	–
KNUX 160405EL-72:T9325	● 0.5	215	0.20	2.0	125	0.18	2.0	200	0.20	2.0	–	–	–	45	0.16	1.6	–	–	–
KNUX 160405EL-72:T9335	● 0.5	185	0.20	2.0	110	0.18	2.0	–	–	–	–	–	–	40	0.16	1.6	–	–	–

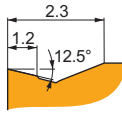

ER-73 geometry with right-handed design for finish to semi-rough machining, and continuous cuts.

KNUX 160405SR-73:6640	● 0.5	150	0.25	3.0	90	0.23	3.0	140	0.25	3.0	–	–	–	–	–	–	–	–	–
KNUX 160410SR-73:6640	● 1.0	150	0.40	3.0	90	0.36	3.0	140	0.40	3.0	–	–	–	–	–	–	–	–	–
KNUX 160410SR-73:T5315	● 1.0	235	0.40	3.0	–	–	–	220	0.40	3.0	–	–	–	–	–	–	–	–	–

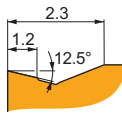

EL-73 geometry with left-handed design for finish to semi-rough machining, and continuous cuts.

KNUX 160405SL-73:6640	● 0.5	150	0.25	3.0	90	0.23	3.0	140	0.25	3.0	–	–	–	–	–	–	–	–	–
KNUX 160410SL-73:6640	● 1.0	150	0.40	3.0	90	0.36	3.0	140	0.40	3.0	–	–	–	–	–	–	–	–	–

LN.X 40, LN.X 50



	W1 (mm)	D1 (mm)	L (mm)	S (mm)
40-1	25.200	9.30	40.00	14.00
50-1	25.400	9.30	50.80	14.00
5014	25.400	6.35	50.80	14.00

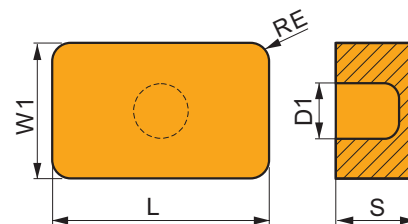

Suitability and starting values for cutting speed (vc), feed (f) and depth of cut (ap). Refer to our Machining Calculator app for further calculations.

Product	RE (mm)	P			M			K			N			S			H		
		vc (m/min)	f (mm/rev)	ap (mm)	vc (m/min)	f (mm/rev)	ap (mm)	vc (m/min)	f (mm/rev)	ap (mm)	vc (m/min)	f (mm/rev)	ap (mm)	vc (m/min)	f (mm/rev)	ap (mm)	vc (m/min)	f (mm/rev)	ap (mm)

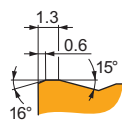

LN.X for heavy rough machining and continuous to interrupted cuts.

LN.X 40-1129003:6630	● 3.2	45	1.35	25.0	–	–	–	40	1.35	25.0	–	–	–	–	–	–	–	–	–
LN.X 40-1129003:T9325	● 3.2	55	1.35	25.0	–	–	–	50	1.35	25.0	–	–	–	–	–	–	–	–	–
LN.X 40-1129003:T9335	● 3.2	40	1.35	25.0	–	–	–	–	–	–	–	–	–	–	–	–	–	–	–

Suitability and starting values for cutting speed (vc), feed (f) and depth of cut (ap). Refer to our Machining Calculator app for further calculations.

Product	RE (mm)	P			M			K			N			S			H		
		vc (m/min)	f (mm/rev)	ap (mm)	vc (m/min)	f (mm/rev)	ap (mm)	vc (m/min)	f (mm/rev)	ap (mm)	vc (m/min)	f (mm/rev)	ap (mm)	vc (m/min)	f (mm/rev)	ap (mm)	vc (m/min)	f (mm/rev)	ap (mm)

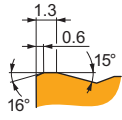

LN.X for heavy rough machining and continuous to interrupted cuts.

LNUX 50-1275000:6630	3.2	45	1.35	25.0	–	–	–	40	1.35	25.0	–	–	–	–	–	–	–	–	–
LNUX 50-1275000:T9325	3.2	55	1.35	25.0	–	–	–	50	1.35	25.0	–	–	–	–	–	–	–	–	–

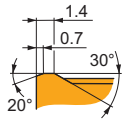
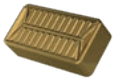

LNM.X design for heavy rough machining and continuous to heavy interrupted cuts.

LNM.X 501432E:T9335	3.2	45	1.50	25.0	–	–	–	–	–	–	–	–	–	–	–	–	–	–	–
---------------------	-----	----	------	------	---	---	---	---	---	---	---	---	---	---	---	---	---	---	---

RCMT



	INSD (mm)	D1 (mm)	S (mm)
1606	16.000	5.50	6.35
2006	20.000	6.50	6.35
2507	25.000	8.60	7.94
3009	30.000	10.00	9.53

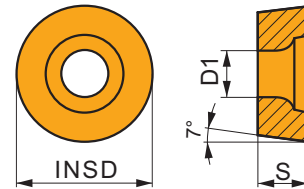

Suitability and starting values for cutting speed (vc), feed (f) and depth of cut (ap). Refer to our Machining Calculator app for further calculations.

Product	RE (mm)	P			M			K			N			S			H		
		vc (m/min)	f (mm/rev)	ap (mm)	vc (m/min)	f (mm/rev)	ap (mm)	vc (m/min)	f (mm/rev)	ap (mm)	vc (m/min)	f (mm/rev)	ap (mm)	vc (m/min)	f (mm/rev)	ap (mm)	vc (m/min)	f (mm/rev)	ap (mm)

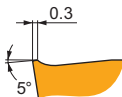
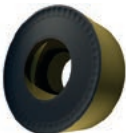

37 for semi-rough to heavy-rough machining, and continuous to interrupted cuts.

RCMT 1606MOS-37:T9325	–	145	0.60	3.0	–	–	–	135	0.60	3.0	–	–	–	–	–	–	–	–	–
RCMT 1606MOS-37:T9415	–	200	0.60	3.0	–	–	–	190	0.60	3.0	–	–	–	–	–	–	–	–	–

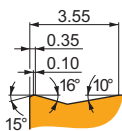

371 for semi-rough to heavy-rough machining, and continuous to interrupted cuts.

RCMT 2006MOS-371:T9325	–	125	0.80	3.0	–	–	–	115	0.80	3.0	–	–	–	–	–	–	–	–	–
RCMT 2006MOS-371:T9415	–	185	0.80	3.0	–	–	–	175	0.80	3.0	–	–	–	–	–	–	–	–	–

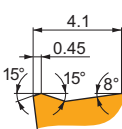

372 for semi-rough to heavy-rough machining, continuous to interrupted cuts.

RCMT 2507MOS-372:T9325	–	90	0.80	3.0	–	–	–	85	0.80	3.0	–	–	–	–	–	–	–	–	–
------------------------	---	----	------	-----	---	---	---	----	------	-----	---	---	---	---	---	---	---	---	---

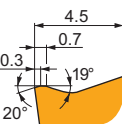
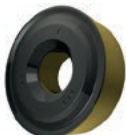

RR4 geometry for heavy rough machining, and continuous to heavy interrupted cuts.

RCMT 3009MO-RR4:T9310	–	90	1.10	4.0	–	–	–	85	1.10	4.0	–	–	–	–	–	–	–	–	–
RCMT 3009MO-RR4:T9315	–	85	1.10	4.0	–	–	–	80	1.10	4.0	–	–	–	–	–	–	–	–	–
RCMT 3009MO-RR4:T9415	–	95	1.10	4.0	–	–	–	90	1.10	4.0	–	–	–	–	–	–	–	–	–

RCMX



	INSD (mm)	D1 (mm)	S (mm)
1003	10.000	3.60	3.18
1204	12.000	4.20	4.76
1606	16.000	5.20	6.35
2006	20.000	6.50	6.35
2507	25.000	7.20	7.94
3209	32.000	9.50	9.53

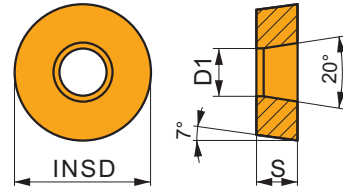

Suitability and starting values for cutting speed (vc), feed (f) and depth of cut (ap). Refer to our Machining Calculator app for further calculations.

Product	RE (mm)	P			M			K			N			S			H		
		vc (m/min)	f (mm/rev)	ap (mm)	vc (m/min)	f (mm/rev)	ap (mm)	vc (m/min)	f (mm/rev)	ap (mm)	vc (m/min)	f (mm/rev)	ap (mm)	vc (m/min)	f (mm/rev)	ap (mm)	vc (m/min)	f (mm/rev)	ap (mm)

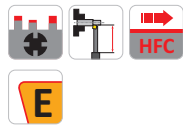
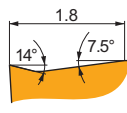

31 for finish to semi-rough machining, and continuous to interrupted cuts.

RCMX 1003MOS-31:T9325	•	-	165	0.50	2.0	95	0.45	2.0	155	0.50	2.0	-	-	-	-	-	-	-	-
------------------------------	---	---	-----	------	-----	----	------	-----	-----	------	-----	---	---	---	---	---	---	---	---

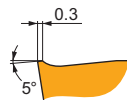
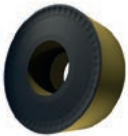

37 for semi-rough to heavy-rough machining, and continuous to interrupted cuts.

RCMX 1606MOS-37:T9325	•	-	145	0.60	3.0	-	-	-	135	0.60	3.0	-	-	-	-	-	-	-	-
RCMX 1606MOS-37:T9415	•	-	200	0.60	3.0	-	-	-	190	0.60	3.0	-	-	-	-	-	-	-	-
RCMX 2006MOS-37:6630	•	-	135	0.60	3.0	-	-	-	125	0.60	3.0	-	-	-	-	-	-	-	-
RCMX 2507MOS-37:6630	•	-	90	0.60	3.0	-	-	-	85	0.60	3.0	-	-	-	-	-	-	-	-

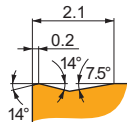
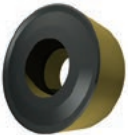

321 for semi-rough to heavy-rough machining, and continuous to interrupted cuts.

RCMX 1204MOS-321:T9325	•	-	120	1.00	3.0	-	-	-	110	1.00	3.0	-	-	-	-	-	-	-	-
RCMX 1204MOS-321:T9415	•	-	170	1.00	3.0	-	-	-	160	1.00	3.0	-	-	-	-	-	-	-	-

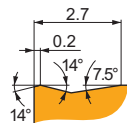
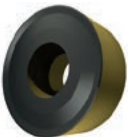

331 for semi-rough to heavy-rough machining, and continuous to interrupted cuts.

RCMX 1606MOS-331:6630	•	-	100	1.20	3.5	-	-	-	95	1.20	3.5	-	-	-	-	-	-	-	-
RCMX 1606MOS-331:T9325	•	-	105	1.20	3.5	-	-	-	95	1.20	3.5	-	-	-	-	-	-	-	-
RCMX 1606MOS-331:T9335	•	-	110	0.80	3.5	-	-	-	-	-	-	-	-	-	-	-	-	-	-
RCMX 1606MOS-331:T9415	•	-	155	1.20	3.5	-	-	-	145	1.20	3.5	-	-	-	-	-	-	-	-

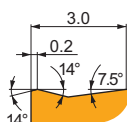

341 for semi-rough to heavy-rough machining, and continuous to interrupted cuts.

RCMX 2006MOS-341:6630	•	-	105	1.00	3.5	-	-	-	95	1.00	3.5	-	-	-	-	-	-	-	-
RCMX 2006MOS-341:6640	•	-	90	1.00	3.5	-	-	-	85	1.00	3.5	-	-	-	-	-	-	-	-

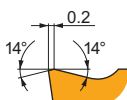

351 for semi-rough to heavy-rough machining, and continuous to interrupted cuts.

RCMX 2507MOS-351:6630	•	-	70	1.00	3.5	-	-	-	65	1.00	3.5	-	-	-	-	-	-	-	-
RCMX 2507MOS-351:6640	•	-	60	1.00	3.5	-	-	-	55	1.00	3.5	-	-	-	-	-	-	-	-

Suitability and starting values for cutting speed (vc), feed (f) and depth of cut (ap). Refer to our Machining Calculator app for further calculations.

Product	RE (mm)	P			M			K			N			S			H		
		vc (m/min)	f (mm/rev)	ap (mm)	vc (m/min)	f (mm/rev)	ap (mm)	vc (m/min)	f (mm/rev)	ap (mm)	vc (m/min)	f (mm/rev)	ap (mm)	vc (m/min)	f (mm/rev)	ap (mm)	vc (m/min)	f (mm/rev)	ap (mm)

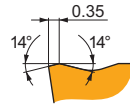

361 for rough to heavy-rough machining and continuous to heavy interrupted cuts.

RCMX 3209MOS-361:6640	✳	-	50	1.40	4.5	-	-	-	45	1.40	4.5	-	-	-	-	-	-	-	-
-----------------------	---	---	----	------	-----	---	---	---	----	------	-----	---	---	---	---	---	---	---	---

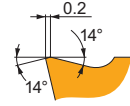
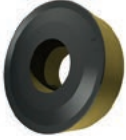

RF1 geometry for finish to semi-rough machining, and continuous to interrupted cuts.

RCMX 2006MO-RF1:T5305	✳	-	105	0.80	3.5	-	-	-	95	0.80	3.5	-	-	-	-	-	-	-	-
RCMX 2006MO-RF1:T9310	✳	-	105	0.80	3.5	-	-	-	95	0.80	3.5	-	-	-	-	-	-	-	-
RCMX 2006MO-RF1:T9315	✳	-	100	0.80	3.5	-	-	-	95	0.80	3.5	-	-	-	-	-	-	-	-
RCMX 2006MO-RF1:T9325	✳	-	90	0.80	3.5	-	-	-	85	0.80	3.5	-	-	-	-	-	-	-	-
RCMX 2006MO-RF1:T9335	-	-	110	0.80	3.5	-	-	-	-	-	-	-	-	-	-	-	-	-	-
RCMX 2006MO-RF1:T9415	✳	-	105	0.80	3.5	-	-	-	95	0.80	3.5	-	-	-	-	-	-	-	-
RCMX 2507MO-RF1:T8345	✳	-	45	1.00	3.5	-	-	-	40	1.00	3.5	-	-	-	-	-	-	-	-
RCMX 2507MO-RF1:T9310	✳	-	95	1.00	3.5	-	-	-	90	1.00	3.5	-	-	-	-	-	-	-	-
RCMX 2507MO-RF1:T9325	✳	-	80	1.00	3.5	-	-	-	75	1.00	3.5	-	-	-	-	-	-	-	-
RCMX 2507MO-RF1:T9335	✳	-	65	1.00	3.5	-	-	-	-	-	-	-	-	-	-	-	-	-	-
RCMX 2507MO-RF1:T9415	✳	-	100	1.00	3.5	-	-	-	95	1.00	3.5	-	-	-	-	-	-	-	-

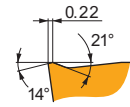

RM1 geometry for finish to rough machining, and continuous to interrupted cuts.

RCMX 2006MO-RM1:T9310	✳	-	95	1.00	3.5	-	-	-	90	1.00	3.5	-	-	-	-	-	-	-	-
RCMX 2006MO-RM1:T9315	✳	-	90	1.00	3.5	-	-	-	85	1.00	3.5	-	-	-	-	-	-	-	-
RCMX 2006MO-RM1:T9325	✳	-	80	1.00	3.5	-	-	-	75	1.00	3.5	-	-	-	-	-	-	-	-
RCMX 2006MO-RM1:T9335	✳	-	125	0.60	3.0	-	-	-	-	-	-	-	-	-	-	-	-	-	-
RCMX 2006MO-RM1:T9415	✳	-	100	1.00	3.5	-	-	-	95	1.00	3.5	-	-	-	-	-	-	-	-
RCMX 2507MO-RM1:T9310	✳	-	95	1.00	3.5	-	-	-	90	1.00	3.5	-	-	-	-	-	-	-	-
RCMX 2507MO-RM1:T9315	✳	-	90	1.00	3.5	-	-	-	85	1.00	3.5	-	-	-	-	-	-	-	-
RCMX 2507MO-RM1:T9325	✳	-	80	1.00	3.5	-	-	-	75	1.00	3.5	-	-	-	-	-	-	-	-
RCMX 2507MO-RM1:T9335	✳	-	80	0.60	3.0	-	-	-	-	-	-	-	-	-	-	-	-	-	-
RCMX 2507MO-RM1:T9415	✳	-	100	1.00	3.5	-	-	-	95	1.00	3.5	-	-	-	-	-	-	-	-

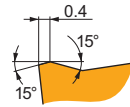
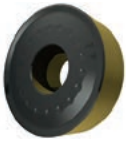

RM2 geometry for semi-rough to rough machining, and continuous to interrupted cuts.

RCMX 2507MO-RM2:T9310	✳	-	90	1.10	3.5	-	-	-	85	1.10	3.5	-	-	-	-	-	-	-	-
RCMX 2507MO-RM2:T9325	✳	-	75	1.10	3.5	-	-	-	70	1.10	3.5	-	-	-	-	-	-	-	-
RCMX 2507MO-RM2:T9415	✳	-	95	1.10	3.5	-	-	-	90	1.10	3.5	-	-	-	-	-	-	-	-
RCMX 3209MO-RM2:T5315	✳	-	95	1.00	4.5	-	-	-	90	1.00	4.5	-	-	-	-	-	-	-	-
RCMX 3209MO-RM2:T9310	✳	-	90	1.00	4.5	-	-	-	85	1.00	4.5	-	-	-	-	-	-	-	-
RCMX 3209MO-RM2:T9315	✳	-	85	1.00	4.5	-	-	-	80	1.00	4.5	-	-	-	-	-	-	-	-
RCMX 3209MO-RM2:T9325	✳	-	75	1.00	4.5	-	-	-	70	1.00	4.5	-	-	-	-	-	-	-	-
RCMX 3209MO-RM2:T9335	✳	-	55	1.40	4.5	-	-	-	-	-	-	-	-	-	-	-	-	-	-
RCMX 3209MO-RM2:T9415	✳	-	95	1.00	4.5	-	-	-	90	1.00	4.5	-	-	-	-	-	-	-	-

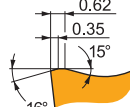
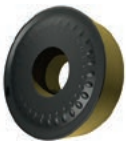

RR2 geometry for heavy rough machining, and continuous to interrupted cuts.

RCMX 3209MO-RR2:T9315	✳	-	60	1.40	4.5	-	-	-	55	1.40	4.5	-	-	-	-	-	-	10	0.70	2.0
RCMX 3209MO-RR2:T9415	✳	-	70	1.40	4.5	-	-	-	65	1.40	4.5	-	-	-	-	-	-	10	0.70	2.0

RNMG



	INSD (mm)	D1 (mm)	S (mm)
1204	12.700	5.16	4.76
1506	15.875	6.35	6.35
1906	19.050	7.94	6.35
2509	25.400	9.12	9.53

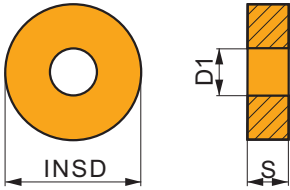

Suitability and starting values for cutting speed (vc), feed (f) and depth of cut (ap). Refer to our Machining Calculator app for further calculations.

Product	RE (mm)	P			M			K			N			S			H		
		vc (m/min)	f (mm/rev)	ap (mm)	vc (m/min)	f (mm/rev)	ap (mm)	vc (m/min)	f (mm/rev)	ap (mm)	vc (m/min)	f (mm/rev)	ap (mm)	vc (m/min)	f (mm/rev)	ap (mm)	vc (m/min)	f (mm/rev)	ap (mm)

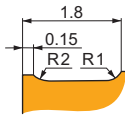
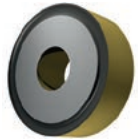

08 for semi-rough to heavy-rough machining, and continuous to interrupted cuts.

RNMG 120400E-08:T5305	●	–	▶	195	0.70	3.0	–	–	–	▶	185	0.70	3.0	–	–	–	–	–	–	▶	35	0.35	0.8
RNMG 120400E-08:T9325	●	–	▶	135	0.70	3.0	–	–	–	▶	125	0.70	3.0	–	–	–	–	–	–	–	–	–	–
RNMG 120400E-08:T9415	●	–	▶	190	0.70	3.0	–	–	–	▶	180	0.70	3.0	–	–	–	–	–	–	▶	35	0.35	0.8
RNMG 150600E-08:T5305	●	–	▶	195	0.70	3.0	–	–	–	▶	185	0.70	3.0	–	–	–	–	–	–	▶	35	0.35	1.0
RNMG 150600E-08:T9325	✱	–	▶	205	0.70	3.0	–	–	–	▶	190	0.70	3.0	–	–	–	–	–	–	–	–	–	–
RNMG 150600E-08:T9415	●	–	▶	190	0.70	3.0	–	–	–	▶	180	0.70	3.0	–	–	–	–	–	–	▶	35	0.35	1.0
RNMG 190600E-08:T9325	●	–	▶	135	0.70	3.0	–	–	–	▶	125	0.70	3.0	–	–	–	–	–	–	–	–	–	–
RNMG 190600E-08:T9415	●	–	▶	190	0.70	3.0	–	–	–	▶	180	0.70	3.0	–	–	–	–	–	–	▶	35	0.35	1.3

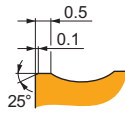
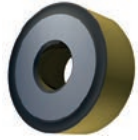

081 for rough to heavy-rough machining, and continuous to interrupted cuts.

RNMG 250900E-081:T9325	✱	–	▶	130	0.90	5.0	–	–	–	▶	120	0.90	5.0	–	–	–	–	–	–	–	–	–	–
RNMG 250900E-081:T9415	●	–	▶	100	0.90	5.0	–	–	–	▶	95	0.90	5.0	–	–	–	–	–	–	▶	20	0.45	1.7

SNMM



	IC (mm)	D1 (mm)	L (mm)	S (mm)
2507	25.400	9.12	25.40	7.94
2509	25.400	9.12	25.40	9.53

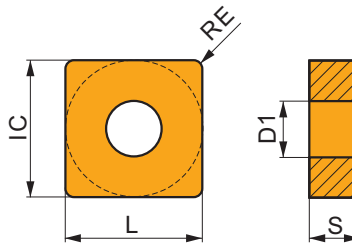

Suitability and starting values for cutting speed (vc), feed (f) and depth of cut (ap). Refer to our Machining Calculator app for further calculations.

Product	Interrupted/ Continuous cut	RE (mm)	P			M			K			N			S			H		
			vc (m/min)	f (mm/rev)	ap (mm)	vc (m/min)	f (mm/rev)	ap (mm)	vc (m/min)	f (mm/rev)	ap (mm)	vc (m/min)	f (mm/rev)	ap (mm)	vc (m/min)	f (mm/rev)	ap (mm)	vc (m/min)	f (mm/rev)	ap (mm)

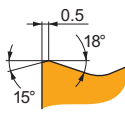

SR geometry for rough to heavy-rough machining, and continuous to interrupted cuts.

SNMM 2507245-SR:T9325	✱	2.4	▶	80	1.00	12.0	▶	45	0.90	12.0	▶	75	1.00	12.0	–	–	–	–	–	–	–	–	–
SNMM 2509245-SR:6630	✱	2.4	▶	65	1.00	14.0	▶	35	0.90	14.0	▶	60	1.00	14.0	–	–	–	–	–	–	–	–	–
SNMM 2509245-SR:T9335	✱	2.4	▶	65	1.00	14.0	▶	35	0.90	14.0	–	–	–	–	–	–	–	–	–	–	–	–	–

SNMX



	IC (mm)	D1 (mm)	L (mm)	S (mm)
2512	25.400	9.17	25.40	12.00

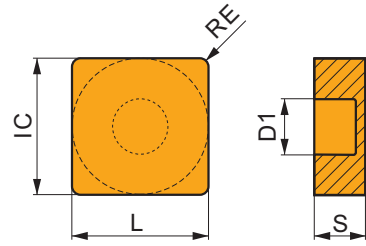

Suitability and starting values for cutting speed (vc), feed (f) and depth of cut (ap). Refer to our Machining Calculator app for further calculations.

Product	RE (mm)	P			M			K			N			S			H		
		vc (m/min)	f (mm/rev)	ap (mm)	vc (m/min)	f (mm/rev)	ap (mm)	vc (m/min)	f (mm/rev)	ap (mm)	vc (m/min)	f (mm/rev)	ap (mm)	vc (m/min)	f (mm/rev)	ap (mm)	vc (m/min)	f (mm/rev)	ap (mm)

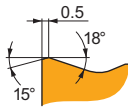
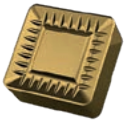

SR geometry for rough to heavy-rough machining, and continuous to interrupted cuts.

SNMX 2512245-SR:6630	•	2.4	65	1.00	14.0	35	0.90	14.0	60	1.00	14.0	-	-	-	-	-	-	-
SNMX 2512245-SR:T8345	•	2.4	45	1.00	14.0	25	0.90	14.0	40	1.00	14.0	-	-	-	-	-	-	-
SNMX 2512245-SR:T9325	•	2.4	80	1.00	14.0	45	0.90	14.0	75	1.00	14.0	-	-	-	-	-	-	-
SNMX 2512245-SR:T9335	•	2.4	65	1.00	14.0	35	0.90	14.0	-	-	-	-	-	-	-	-	-	-

TNMM



	IC (mm)	D1 (mm)	L (mm)	S (mm)
2204	12.700	5.16	22.00	4.76

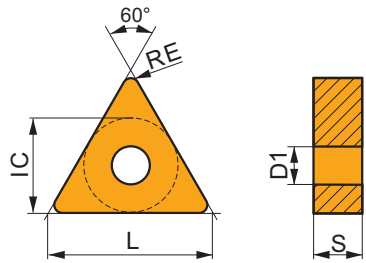

Suitability and starting values for cutting speed (vc), feed (f) and depth of cut (ap). Refer to our Machining Calculator app for further calculations.

Product	RE (mm)	P			M			K			N			S			H		
		vc (m/min)	f (mm/rev)	ap (mm)	vc (m/min)	f (mm/rev)	ap (mm)	vc (m/min)	f (mm/rev)	ap (mm)	vc (m/min)	f (mm/rev)	ap (mm)	vc (m/min)	f (mm/rev)	ap (mm)	vc (m/min)	f (mm/rev)	ap (mm)

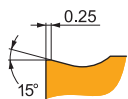

ER geometry with right-handed design for medium to semi-rough machining, and continuous cuts.

TNMM 220412ER:T9335	•	1.2	190	0.35	2.1	110	0.32	2.1	-	-	-	-	-	-	40	0.25	1.7	-	-	-
---------------------	---	-----	-----	------	-----	-----	------	-----	---	---	---	---	---	---	----	------	-----	---	---	---

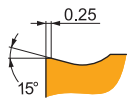

EL geometry with left handed design for medium to semi-rough machining, and continuous cuts.

TNMM 220412EL:T9335	•	1.2	190	0.35	2.1	110	0.32	2.1	-	-	-	-	-	-	40	0.25	1.7	-	-	-
---------------------	---	-----	-----	------	-----	-----	------	-----	---	---	---	---	---	---	----	------	-----	---	---	---

SPMR



	IC (mm)	L (mm)	S (mm)
0903	9.525	9.53	3.18
1203	12.700	12.70	3.18

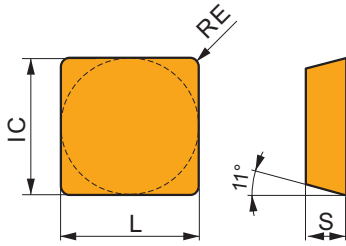

Suitability and starting values for cutting speed (vc), feed (f) and depth of cut (ap). Refer to our Machining Calculator app for further calculations.

Product	RE (mm)	P			M			K			N			S			H		
		vc (m/min)	f (mm/rev)	ap (mm)	vc (m/min)	f (mm/rev)	ap (mm)	vc (m/min)	f (mm/rev)	ap (mm)	vc (m/min)	f (mm/rev)	ap (mm)	vc (m/min)	f (mm/rev)	ap (mm)	vc (m/min)	f (mm/rev)	ap (mm)

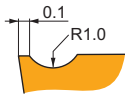

46 for fine to finish machining, and continuous to interrupted cuts.

SPMR 090304E-46:T9325	● 0.4	■ 215	■ 0.15	■ 1.0	■ 125	■ 0.15	■ 1.0	■ 200	■ 0.15	■ 1.0	■ -	■ -	■ -	■ -	■ -	■ -	■ -	■ -	■ -
SPMR 090308E-46:T9325	● 0.8	■ 255	■ 0.15	■ 1.0	■ 150	■ 0.15	■ 1.0	■ 240	■ 0.15	■ 1.0	■ -	■ -	■ -	■ -	■ -	■ -	■ -	■ -	■ -

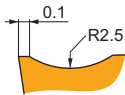
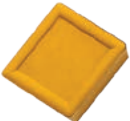

48 for finish to semi-rough machining, and continuous to interrupted cuts.

SPMR 120304E-48:T9325	● 0.4	■ 170	■ 0.22	■ 2.2	■ 100	■ 0.22	■ 2.2	■ 160	■ 0.22	■ 2.2	■ -	■ -	■ -	■ -	■ -	■ -	■ -	■ -	■ -
SPMR 120304E-48:T9335	● 0.4	■ 145	■ 0.22	■ 2.2	■ 85	■ 0.22	■ 2.2	■ -	■ -	■ -	■ -	■ -	■ -	■ -	■ -	■ -	■ -	■ -	■ -
SPMR 120308E-48:6640	● 0.8	■ 160	■ 0.22	■ 2.2	■ 95	■ 0.22	■ 2.2	■ 150	■ 0.22	■ 2.2	■ -	■ -	■ -	■ -	■ -	■ -	■ -	■ -	■ -
SPMR 120308E-48:T9325	● 0.8	■ 205	■ 0.22	■ 2.2	■ 120	■ 0.22	■ 2.2	■ 190	■ 0.22	■ 2.2	■ -	■ -	■ -	■ -	■ -	■ -	■ -	■ -	■ -
SPMR 120308E-48:T9335	● 0.8	■ 175	■ 0.22	■ 2.2	■ 105	■ 0.22	■ 2.2	■ -	■ -	■ -	■ -	■ -	■ -	■ -	■ -	■ -	■ -	■ -	■ -
SPMR 120312E-48:T9325	● 1.2	■ 215	■ 0.22	■ 2.2	■ 125	■ 0.22	■ 2.2	■ 200	■ 0.22	■ 2.2	■ -	■ -	■ -	■ -	■ -	■ -	■ -	■ -	■ -

TPMR



	IC (mm)	L (mm)	S (mm)
1103	6.350	11.00	3.18
1603	9.525	16.50	3.18

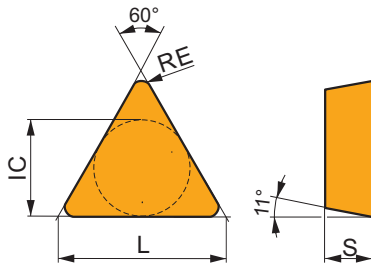

Suitability and starting values for cutting speed (vc), feed (f) and depth of cut (ap). Refer to our Machining Calculator app for further calculations.

Product	RE (mm)	P			M			K			N			S			H		
		vc (m/min)	f (mm/rev)	ap (mm)	vc (m/min)	f (mm/rev)	ap (mm)	vc (m/min)	f (mm/rev)	ap (mm)	vc (m/min)	f (mm/rev)	ap (mm)	vc (m/min)	f (mm/rev)	ap (mm)	vc (m/min)	f (mm/rev)	ap (mm)

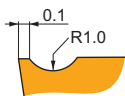

46 for fine to finish machining, and continuous to interrupted cuts.

TPMR 110304E-46:6640	● 0.4	■ 140	■ 0.15	■ 1.0	■ 80	■ 0.14	■ 1.0	■ 130	■ 0.15	■ 1.0	■ -	■ -	■ -	■ -	■ -	■ -	■ -	■ -	■ -
TPMR 110304E-46:T9325	● 0.4	■ 175	■ 0.15	■ 1.0	■ 105	■ 0.15	■ 1.0	■ 165	■ 0.15	■ 1.0	■ -	■ -	■ -	■ -	■ -	■ -	■ -	■ -	■ -
TPMR 110304E-46:T9335	● 0.4	■ 150	■ 0.15	■ 1.0	■ 90	■ 0.15	■ 1.0	■ -	■ -	■ -	■ -	■ -	■ -	■ -	■ -	■ -	■ -	■ -	■ -
TPMR 110308E-46:6640	● 0.8	■ 170	■ 0.15	■ 1.0	■ 100	■ 0.14	■ 1.0	■ 160	■ 0.15	■ 1.0	■ -	■ -	■ -	■ -	■ -	■ -	■ -	■ -	■ -
TPMR 110308E-46:T9325	● 0.8	■ 205	■ 0.15	■ 1.0	■ 120	■ 0.15	■ 1.0	■ 190	■ 0.15	■ 1.0	■ -	■ -	■ -	■ -	■ -	■ -	■ -	■ -	■ -
TPMR 110308E-46:T9335	● 0.8	■ 180	■ 0.15	■ 1.0	■ 105	■ 0.15	■ 1.0	■ -	■ -	■ -	■ -	■ -	■ -	■ -	■ -	■ -	■ -	■ -	■ -

Suitability and starting values for cutting speed (vc), feed (f) and depth of cut (ap). Refer to our Machining Calculator app for further calculations.

Product	RE (mm)	P			M			K			N			S			H		
		vc (m/min)	f (mm/rev)	ap (mm)	vc (m/min)	f (mm/rev)	ap (mm)	vc (m/min)	f (mm/rev)	ap (mm)	vc (m/min)	f (mm/rev)	ap (mm)	vc (m/min)	f (mm/rev)	ap (mm)	vc (m/min)	f (mm/rev)	ap (mm)

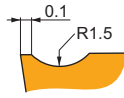

47 for finish to semi-rough machining, and continuous to interrupted cuts.

TPMR 160304E-47:6640	● 0.4	■ 120	0.20	1.5	▣ 70	0.18	1.5	■ 110	0.20	1.5	—	—	—	—	—	—	—	—
TPMR 160304E-47:T9325	● 0.4	■ 150	0.20	1.5	▣ 90	0.18	1.5	▣ 140	0.20	1.5	—	—	—	—	—	—	—	—
TPMR 160304E-47:T9335	● 0.4	■ 125	0.20	1.5	▣ 75	0.18	1.5	—	—	—	—	—	—	—	—	—	—	—
TPMR 160308E-47:6640	● 0.8	■ 140	0.20	1.5	▣ 80	0.18	1.5	■ 130	0.20	1.5	—	—	—	—	—	—	—	—
TPMR 160308E-47:T9325	● 0.8	■ 175	0.20	1.5	▣ 105	0.18	1.5	▣ 165	0.20	1.5	—	—	—	—	—	—	—	—
TPMR 160308E-47:T9335	● 0.8	■ 150	0.20	1.5	▣ 90	0.18	1.5	—	—	—	—	—	—	—	—	—	—	—
TPMR 160312E-47:T9325	● 1.2	■ 185	0.20	1.5	▣ 110	0.18	1.5	▣ 175	0.20	1.5	—	—	—	—	—	—	—	—
TPMR 160312E-47:T9335	● 1.2	■ 160	0.20	1.5	▣ 95	0.18	1.5	—	—	—	—	—	—	—	—	—	—	—

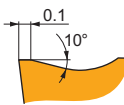

61 for finish machining with moderate feeds and depths of cut, and continuous to interrupted cuts.

TPMR 160308E-61:T9325	● 0.8	■ 135	0.35	1.8	▣ 80	0.32	1.8	▣ 125	0.35	1.8	—	—	—	—	—	—	—	—
TPMR 160308E-61:T9335	● 0.8	■ 120	0.35	1.8	▣ 70	0.32	1.8	—	—	—	—	—	—	—	—	—	—	—

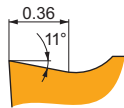

PF2 geometry for fine to finish machining, and continuous cuts.

TPMR 110304-PF2:TT010	● 0.4	■ 255	0.10	0.5	▣ 150	0.10	0.5	—	—	—	—	—	—	—	—	—	—	—
TPMR 160304-PF2:TT010	● 0.4	■ 255	0.10	0.5	▣ 150	0.10	0.5	—	—	—	—	—	—	—	—	—	—	—

SPUN-IT



	IC (mm)	L (mm)	M (mm)	S (mm)
1203	12.700	12.70	2.3	3.18
1504	15.875	15.88	2.8	4.76
1904	19.050	19.05	3.5	4.76
2506	25.400	25.40	4.4	6.35

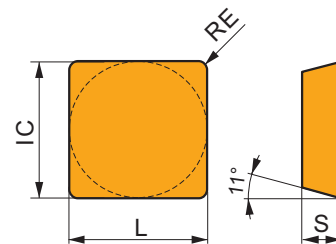

Suitability and starting values for cutting speed (vc), feed (f) and depth of cut (ap). Refer to our Machining Calculator app for further calculations.

Product	RE (mm)	P			M			K			N			S			H		
		vc (m/min)	f (mm/rev)	ap (mm)	vc (m/min)	f (mm/rev)	ap (mm)	vc (m/min)	f (mm/rev)	ap (mm)	vc (m/min)	f (mm/rev)	ap (mm)	vc (m/min)	f (mm/rev)	ap (mm)	vc (m/min)	f (mm/rev)	ap (mm)



SPUN for fine-finish to semi-rough machining, and continuous to slightly interrupted cuts.

SPUN 120308:6640	● 0.8	■ 180	0.15	4.0	—	—	—	▣ 170	0.15	4.0	—	—	—	—	—	—	—	—
SPUN 120312:6640	● 1.2	■ 190	0.15	4.0	—	—	—	▣ 180	0.15	4.0	—	—	—	—	—	—	—	—
SPUN 150408:6640	● 0.8	■ 155	0.20	5.0	—	—	—	▣ 145	0.20	5.0	—	—	—	—	—	—	—	—

Suitability and starting values for cutting speed (vc), feed (f) and depth of cut (ap). Refer to our Machining Calculator app for further calculations.

Product	RE (mm)	P			M			K			N			S			H		
		vc (m/min)	f (mm/rev)	ap (mm)	vc (m/min)	f (mm/rev)	ap (mm)	vc (m/min)	f (mm/rev)	ap (mm)	vc (m/min)	f (mm/rev)	ap (mm)	vc (m/min)	f (mm/rev)	ap (mm)	vc (m/min)	f (mm/rev)	ap (mm)



SPUN for fine-finish to semi-rough machining, and continuous to slightly interrupted cuts.

SPUN 150412:6640	1.2	165	0.20	5.0	–	–	–	155	0.20	5.0	–	–	–	–	–	–	–	–	–
SPUN 190408:6640	0.8	150	0.20	6.0	–	–	–	140	0.20	6.0	–	–	–	–	–	–	–	–	–
SPUN 190412:6640	1.2	160	0.20	6.0	–	–	–	150	0.20	6.0	–	–	–	–	–	–	–	–	–
SPUN 190416:6640	1.6	165	0.20	6.0	–	–	–	155	0.20	6.0	–	–	–	–	–	–	–	–	–

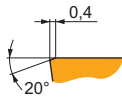

SPUN..S for fine-finish to semi-rough machining, and continuous to slightly interrupted cuts.

SPUN 250620S:6640	2.0	80	0.40	12.0	–	–	–	75	0.40	12.0	–	–	–	–	–	–	–	–	–
-------------------	-----	----	------	------	---	---	---	----	------	------	---	---	---	---	---	---	---	---	---

TPUN-IT



	IC (mm)	L (mm)	S (mm)
1103	6.350	11.00	3.18
1603	9.525	16.50	3.18
2204	12.700	22.00	4.76
2706	15.875	27.50	6.35
3306	19.050	33.00	6.35

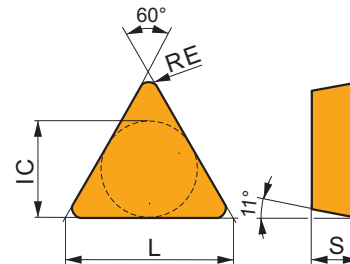

Suitability and starting values for cutting speed (vc), feed (f) and depth of cut (ap). Refer to our Machining Calculator app for further calculations.

Product	RE (mm)	P			M			K			N			S			H		
		vc (m/min)	f (mm/rev)	ap (mm)	vc (m/min)	f (mm/rev)	ap (mm)	vc (m/min)	f (mm/rev)	ap (mm)	vc (m/min)	f (mm/rev)	ap (mm)	vc (m/min)	f (mm/rev)	ap (mm)	vc (m/min)	f (mm/rev)	ap (mm)



TPUN for fine-finish to semi-rough machining, and continuous to slightly interrupted cuts.

TPUN 110304:6640	0.4	135	0.10	1.2	–	–	–	125	0.10	1.2	–	–	–	–	–	–	–	–	–
TPUN 110308:6640	0.8	125	0.18	1.2	–	–	–	115	0.18	1.2	–	–	–	–	–	–	–	–	–
TPUN 160304:6640	0.4	135	0.10	1.5	–	–	–	125	0.10	1.5	–	–	–	–	–	–	–	–	–
TPUN 160308:6640	0.8	125	0.18	1.5	–	–	–	115	0.18	1.5	–	–	–	–	–	–	–	–	–
TPUN 160312:6640	1.2	125	0.20	1.5	–	–	–	115	0.20	1.5	–	–	–	–	–	–	–	–	–
TPUN 220408:6640	0.8	120	0.18	2.0	–	–	–	110	0.18	2.0	–	–	–	–	–	–	–	–	–
TPUN 220412:6640	1.2	120	0.20	2.0	–	–	–	110	0.20	2.0	–	–	–	–	–	–	–	–	–

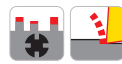

TPUN..S for fine-finish to semi-rough machining, and continuous to slightly interrupted cuts.

TPUN 270616S:6640	1.6	65	0.30	5.0	–	–	–	60	0.30	5.0	–	–	–	–	–	–	–	–	–
TPUN 330620S:6640	2.0	65	0.30	5.0	–	–	–	60	0.30	5.0	–	–	–	–	–	–	–	–	–

CNGA CER



	IC (mm)	D1 (mm)	L (mm)	S (mm)
1204	12.700	5.16	12.90	4.76

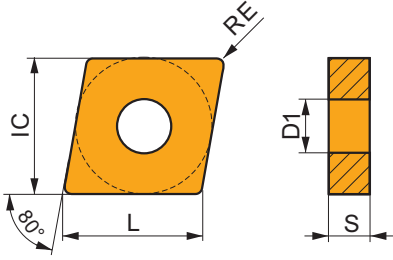

Suitability and starting values for cutting speed (vc), feed (f) and depth of cut (ap). Refer to our Machining Calculator app for further calculations.

Product	RE (mm)	P			M			K			N			S			H		
		vc (m/min)	f (mm/rev)	ap (mm)	vc (m/min)	f (mm/rev)	ap (mm)	vc (m/min)	f (mm/rev)	ap (mm)	vc (m/min)	f (mm/rev)	ap (mm)	vc (m/min)	f (mm/rev)	ap (mm)	vc (m/min)	f (mm/rev)	ap (mm)

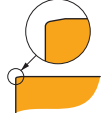
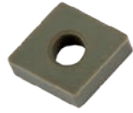

CER for machining with high speeds and continuous cuts.

CNGA 120404 T02020:TC100	● 0.4	-	-	-	-	-	-	■ 590	0.10	2.0	-	-	-	-	-	-	-	-	-
CNGA 120408 T01020:TC100	● 0.8	-	-	-	-	-	-	■ 550	0.20	2.0	-	-	-	-	-	-	-	-	-
CNGA 120412 T01020:TC100	● 1.2	-	-	-	-	-	-	■ 540	0.25	2.0	-	-	-	-	-	-	-	-	-

CNGN CER



	IC (mm)	L (mm)	S (mm)
1204	12.700	12.90	4.76
1207	12.700	12.90	7.94

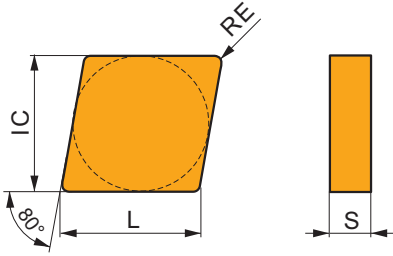

Suitability and starting values for cutting speed (vc), feed (f) and depth of cut (ap). Refer to our Machining Calculator app for further calculations.

Product	RE (mm)	P			M			K			N			S			H		
		vc (m/min)	f (mm/rev)	ap (mm)	vc (m/min)	f (mm/rev)	ap (mm)	vc (m/min)	f (mm/rev)	ap (mm)	vc (m/min)	f (mm/rev)	ap (mm)	vc (m/min)	f (mm/rev)	ap (mm)	vc (m/min)	f (mm/rev)	ap (mm)

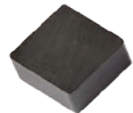

CER for machining with high speeds and continuous cuts.

CNGN 120408 T01020:TC100	● 0.8	-	-	-	-	-	-	■ 550	0.20	2.0	-	-	-	-	-	-	-	-	-
CNGN 120708 T01020:TC100	● 0.8	-	-	-	-	-	-	■ 550	0.20	2.0	-	-	-	-	-	-	-	-	-
CNGN 120712 T01020:TC100	● 1.2	-	-	-	-	-	-	■ 540	0.25	2.0	-	-	-	-	-	-	-	-	-

DNGA CER



	IC (mm)	D1 (mm)	L (mm)	S (mm)
1504	12.700	5.16	15.50	4.76

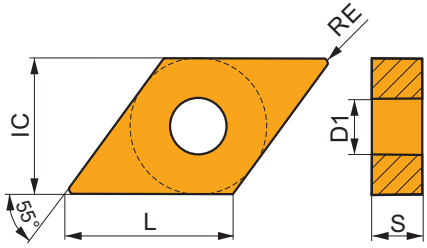

Suitability and starting values for cutting speed (vc), feed (f) and depth of cut (ap). Refer to our Machining Calculator app for further calculations.

Product	RE (mm)	P			M			K			N			S			H		
		vc (m/min)	f (mm/rev)	ap (mm)	vc (m/min)	f (mm/rev)	ap (mm)	vc (m/min)	f (mm/rev)	ap (mm)	vc (m/min)	f (mm/rev)	ap (mm)	vc (m/min)	f (mm/rev)	ap (mm)	vc (m/min)	f (mm/rev)	ap (mm)

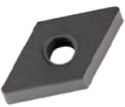

CER for machining with high speeds and continuous cuts.

DNGA 150408 S02020:TC100	● 0.8	-	-	-	-	-	-	450	0.20	1.5	-	-	-	-	-	-	-	-	-
---------------------------------	-------	---	---	---	---	---	---	-----	------	-----	---	---	---	---	---	---	---	---	---



CER for machining with high speeds and continuous cuts.

DNGA 150404 T01020:TC100	● 0.4	-	-	-	-	-	-	475	0.10	1.5	-	-	-	-	-	-	-	-	-
DNGA 150408 T00520:TC100	● 0.8	-	-	-	-	-	-	450	0.20	1.5	-	-	-	-	-	-	-	-	-

DNGN CER



	IC (mm)	L (mm)	S (mm)
1504	12.700	15.50	4.76

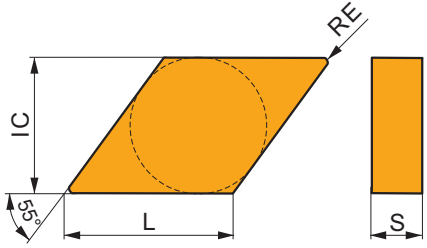

Suitability and starting values for cutting speed (vc), feed (f) and depth of cut (ap). Refer to our Machining Calculator app for further calculations.

Product	RE (mm)	P			M			K			N			S			H		
		vc (m/min)	f (mm/rev)	ap (mm)	vc (m/min)	f (mm/rev)	ap (mm)	vc (m/min)	f (mm/rev)	ap (mm)	vc (m/min)	f (mm/rev)	ap (mm)	vc (m/min)	f (mm/rev)	ap (mm)	vc (m/min)	f (mm/rev)	ap (mm)

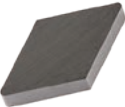

CER for machining with high speeds and continuous cuts.

DNGN 150408 T01020:TC100	● 0.8	-	-	-	-	-	-	450	0.20	1.5	-	-	-	-	-	-	-	-	-
---------------------------------	-------	---	---	---	---	---	---	-----	------	-----	---	---	---	---	---	---	---	---	---

RCGX CER



	INSD (mm)	S (mm)
0606	6.350	6.35
0907	9.525	7.94
1207	12.700	7.94

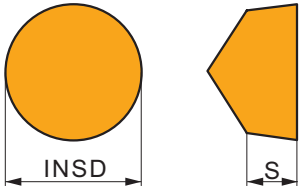

Suitability and starting values for cutting speed (vc), feed (f) and depth of cut (ap). Refer to our Machining Calculator app for further calculations.

Product	RE (mm)	P			M			K			N			S			H		
		vc (m/min)	f (mm/rev)	ap (mm)	vc (m/min)	f (mm/rev)	ap (mm)	vc (m/min)	f (mm/rev)	ap (mm)	vc (m/min)	f (mm/rev)	ap (mm)	vc (m/min)	f (mm/rev)	ap (mm)	vc (m/min)	f (mm/rev)	ap (mm)



CER for machining with high speeds and continuous cuts.

RCGX 060600 K15015:TC100	●	–	–	–	–	–	–	365	0.30	0.8	–	–	–	–	–	–	–	–	–
RCGX 090700 K15015:TC100	●	–	–	–	–	–	–	410	0.20	1.2	–	–	–	–	–	–	–	–	–
RCGX 120700 K15015:TC100	●	–	–	–	–	–	–	405	0.20	1.5	–	–	–	–	–	–	–	–	–

RNGN CER



	INSD (mm)	S (mm)
0903	9.525	3.18
1204	12.700	4.76
1207	12.700	7.94

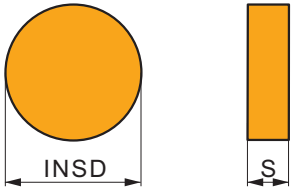

Suitability and starting values for cutting speed (vc), feed (f) and depth of cut (ap). Refer to our Machining Calculator app for further calculations.

Product	RE (mm)	P			M			K			N			S			H		
		vc (m/min)	f (mm/rev)	ap (mm)	vc (m/min)	f (mm/rev)	ap (mm)	vc (m/min)	f (mm/rev)	ap (mm)	vc (m/min)	f (mm/rev)	ap (mm)	vc (m/min)	f (mm/rev)	ap (mm)	vc (m/min)	f (mm/rev)	ap (mm)



CER for machining with high speeds and continuous cuts.

RNGN 090300 T01020:TC100	●	–	–	–	–	–	–	460	0.20	1.2	–	–	–	–	–	–	–	–	–
RNGN 120400 T01020:TC100	●	–	–	–	–	–	–	455	0.20	1.5	–	–	–	–	–	–	–	–	–
RNGN 120700 T01020:TC100	●	–	–	–	–	–	–	455	0.20	1.5	–	–	–	–	–	–	–	–	–
RNGN 120700 T15015:TC100	●	–	–	–	–	–	–	455	0.20	1.5	–	–	–	–	–	–	–	–	–

SNGA CER



	IC (mm)	D1 (mm)	L (mm)	S (mm)
1204	12.700	5.16	12.70	4.76

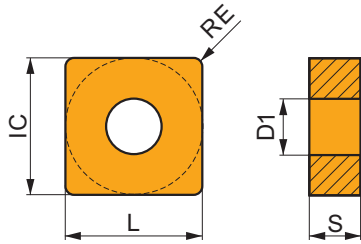

Suitability and starting values for cutting speed (vc), feed (f) and depth of cut (ap). Refer to our Machining Calculator app for further calculations.

Product	RE (mm)	P			M			K			N			S			H		
		vc (m/min)	f (mm/rev)	ap (mm)	vc (m/min)	f (mm/rev)	ap (mm)	vc (m/min)	f (mm/rev)	ap (mm)	vc (m/min)	f (mm/rev)	ap (mm)	vc (m/min)	f (mm/rev)	ap (mm)	vc (m/min)	f (mm/rev)	ap (mm)



CER for machining with high speeds and continuous cuts.

SNGA 120408 T01025:TC100	● 0.8	-	-	-	-	-	-	■ 575	0.20	2.0	-	-	-	-	-	-	-	-	-
SNGA 120412 T01020:TC100	● 1.2	-	-	-	-	-	-	■ 565	0.25	2.0	-	-	-	-	-	-	-	-	-

SNGN CER



	IC (mm)	L (mm)	S (mm)
0903	9.525	9.53	3.18
1204	12.700	12.70	4.76
1207	12.700	12.70	7.94

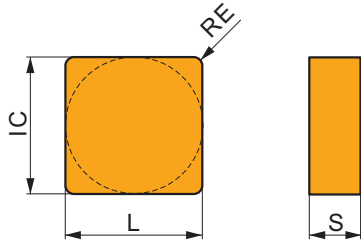

Suitability and starting values for cutting speed (vc), feed (f) and depth of cut (ap). Refer to our Machining Calculator app for further calculations.

Product	RE (mm)	P			M			K			N			S			H		
		vc (m/min)	f (mm/rev)	ap (mm)	vc (m/min)	f (mm/rev)	ap (mm)	vc (m/min)	f (mm/rev)	ap (mm)	vc (m/min)	f (mm/rev)	ap (mm)	vc (m/min)	f (mm/rev)	ap (mm)	vc (m/min)	f (mm/rev)	ap (mm)

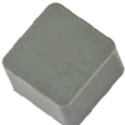

CER for machining with high speeds and continuous cuts.

SNGN 090308 T01020:TC100	● 0.8	-	-	-	-	-	-	■ 580	0.20	1.8	-	-	-	-	-	-	-	-	-
SNGN 090312 T01020:TC100	● 1.2	-	-	-	-	-	-	■ 565	0.25	1.8	-	-	-	-	-	-	-	-	-
SNGN 120404 T01020:TC100	● 0.4	-	-	-	-	-	-	■ 620	0.10	2.0	-	-	-	-	-	-	-	-	-
SNGN 120408 T01020:TC100	● 0.8	-	-	-	-	-	-	■ 575	0.20	2.0	-	-	-	-	-	-	-	-	-
SNGN 120708 T01020:TC100	● 0.8	-	-	-	-	-	-	■ 575	0.20	2.0	-	-	-	-	-	-	-	-	-
SNGN 120712 T01020:TC100	● 1.2	-	-	-	-	-	-	■ 565	0.25	2.0	-	-	-	-	-	-	-	-	-

SPGN CER



	IC (mm)	L (mm)	S (mm)
1203	12.700	12.70	3.18

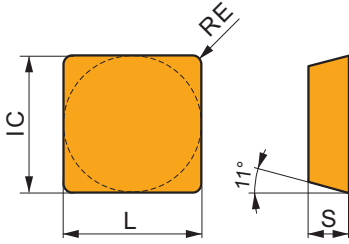

Suitability and starting values for cutting speed (vc), feed (f) and depth of cut (ap). Refer to our Machining Calculator app for further calculations.

Product	RE (mm)	P			M			K			N			S			H		
		vc (m/min)	f (mm/rev)	ap (mm)	vc (m/min)	f (mm/rev)	ap (mm)	vc (m/min)	f (mm/rev)	ap (mm)	vc (m/min)	f (mm/rev)	ap (mm)	vc (m/min)	f (mm/rev)	ap (mm)	vc (m/min)	f (mm/rev)	ap (mm)

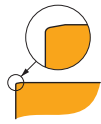
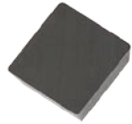

CER for machining with high speeds and continuous cuts.

SPGN 120308 T01020:TC100	● 0.8	-	-	-	-	-	-	■ 530	0.20	1.5	-	-	-	-	-	-	-	-
---------------------------------	-------	---	---	---	---	---	---	-------	------	-----	---	---	---	---	---	---	---	---

TNGA CER



	IC (mm)	D1 (mm)	L (mm)	S (mm)
1604	9.525	3.81	16.50	4.76

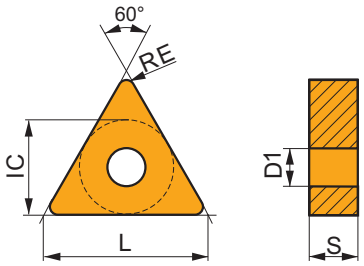

Suitability and starting values for cutting speed (vc), feed (f) and depth of cut (ap). Refer to our Machining Calculator app for further calculations.

Product	RE (mm)	P			M			K			N			S			H		
		vc (m/min)	f (mm/rev)	ap (mm)	vc (m/min)	f (mm/rev)	ap (mm)	vc (m/min)	f (mm/rev)	ap (mm)	vc (m/min)	f (mm/rev)	ap (mm)	vc (m/min)	f (mm/rev)	ap (mm)	vc (m/min)	f (mm/rev)	ap (mm)



CER for machining with high speeds and continuous cuts.

TNGA 160408 T01020:TC100	● 0.8	-	-	-	-	-	-	■ 475	0.20	1.5	-	-	-	-	-	-	-	-
TNGA 160412 T01020:TC100	● 1.2	-	-	-	-	-	-	■ 500	0.20	1.5	-	-	-	-	-	-	-	-

TNGN CER



	IC (mm)	L (mm)	S (mm)
1604	9.525	16.50	4.76
1607	9.525	16.50	7.94

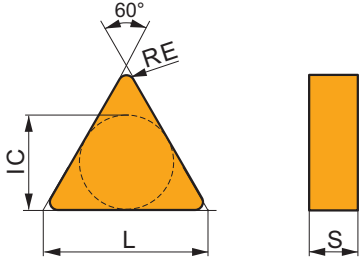

Suitability and starting values for cutting speed (vc), feed (f) and depth of cut (ap). Refer to our Machining Calculator app for further calculations.

Product	RE (mm)	P			M			K			N			S			H		
		vc (m/min)	f (mm/rev)	ap (mm)	vc (m/min)	f (mm/rev)	ap (mm)	vc (m/min)	f (mm/rev)	ap (mm)	vc (m/min)	f (mm/rev)	ap (mm)	vc (m/min)	f (mm/rev)	ap (mm)	vc (m/min)	f (mm/rev)	ap (mm)

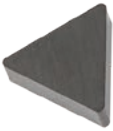

CER for machining with high speeds and continuous cuts.

TNGN 160408 T01020:TC100	● 0.8	–	–	–	–	–	–	■ 475	0.20	1.5	–	–	–	–	–	–	–	–	–
TNGN 160412 T01020:TC100	● 1.2	–	–	–	–	–	–	■ 500	0.20	1.5	–	–	–	–	–	–	–	–	–
TNGN 160708 T02020:TC100	● 0.8	–	–	–	–	–	–	■ 475	0.20	1.5	–	–	–	–	–	–	–	–	–

TPGN CER



	IC (mm)	L (mm)	S (mm)
1103	6.350	11.00	3.18
1603	9.525	16.50	3.18

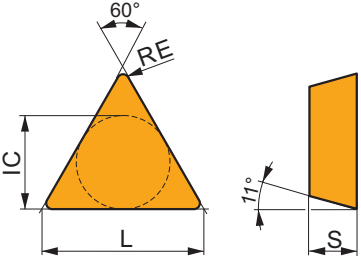

Suitability and starting values for cutting speed (vc), feed (f) and depth of cut (ap). Refer to our Machining Calculator app for further calculations.

Product	RE (mm)	P			M			K			N			S			H		
		vc (m/min)	f (mm/rev)	ap (mm)	vc (m/min)	f (mm/rev)	ap (mm)	vc (m/min)	f (mm/rev)	ap (mm)	vc (m/min)	f (mm/rev)	ap (mm)	vc (m/min)	f (mm/rev)	ap (mm)	vc (m/min)	f (mm/rev)	ap (mm)



CER for machining with high speeds and continuous cuts.

TPGN 110304 T01020:TC100	● 0.4	–	–	–	–	–	–	■ 460	0.10	1.5	–	–	–	–	–	–	–	–	–
TPGN 110308 T01020:TC100	● 0.8	–	–	–	–	–	–	■ 425	0.20	1.5	–	–	–	–	–	–	–	–	–
TPGN 160304 T01020:TC100	● 0.4	–	–	–	–	–	–	■ 460	0.10	1.5	–	–	–	–	–	–	–	–	–
TPGN 160308 T01020:TC100	● 0.8	–	–	–	–	–	–	■ 425	0.20	1.5	–	–	–	–	–	–	–	–	–
TPGN 160312 T01020:TC100	● 1.2	–	–	–	–	–	–	■ 450	0.20	1.5	–	–	–	–	–	–	–	–	–

VNGA CER



	IC (mm)	D1 (mm)	L (mm)	S (mm)
1604	9.525	3.81	16.60	4.76

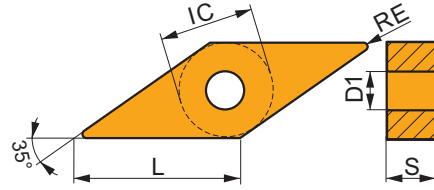

Suitability and starting values for cutting speed (vc), feed (f) and depth of cut (ap). Refer to our Machining Calculator app for further calculations.

Product	RE (mm)	P			M			K			N			S			H		
		vc (m/min)	f (mm/rev)	ap (mm)	vc (m/min)	f (mm/rev)	ap (mm)	vc (m/min)	f (mm/rev)	ap (mm)	vc (m/min)	f (mm/rev)	ap (mm)	vc (m/min)	f (mm/rev)	ap (mm)	vc (m/min)	f (mm/rev)	ap (mm)

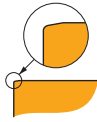

CER for machining with high speeds and continuous cuts.

VNGA 160404 T01020:TC100	● 0.4	-	-	-	-	-	-	425	0.10	1.0	-	-	-	-	-	-	-	-
VNGA 160408 T01020:TC100	● 0.8	-	-	-	-	-	-	395	0.20	1.0	-	-	-	-	-	-	-	-

DCMW PCD



	IC (mm)	D1 (mm)	L (mm)	S (mm)
11T3	9.525	4.40	11.60	3.97

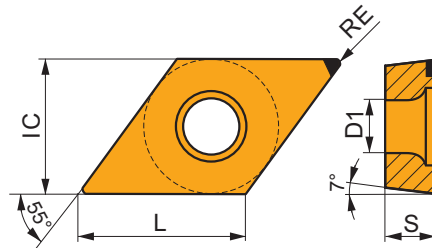

Suitability and starting values for cutting speed (vc), feed (f) and depth of cut (ap). Refer to our Machining Calculator app for further calculations.

Product	RE (mm)	P			M			K			N			S			H		
		vc (m/min)	f (mm/rev)	ap (mm)	vc (m/min)	f (mm/rev)	ap (mm)	vc (m/min)	f (mm/rev)	ap (mm)	vc (m/min)	f (mm/rev)	ap (mm)	vc (m/min)	f (mm/rev)	ap (mm)	vc (m/min)	f (mm/rev)	ap (mm)

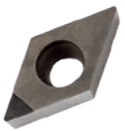

PCD for finish machining, high speeds and stable cutting conditions.

DCMW 11T304FN:PD1	● 0.4	-	-	-	-	-	-	-	-	-	1035	0.12	0.5	-	-	-	-	-
DCMW 11T308FN:PD1	● 0.8	-	-	-	-	-	-	-	-	-	1200	0.12	1.0	-	-	-	-	-

VCMW PCD



	IC (mm)	D1 (mm)	L (mm)	S (mm)
1604	9.525	4.40	16.60	4.76

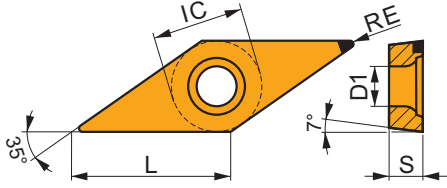

Suitability and starting values for cutting speed (vc), feed (f) and depth of cut (ap). Refer to our Machining Calculator app for further calculations.

Product	RE (mm)	P			M			K			N			S			H		
		vc (m/min)	f (mm/rev)	ap (mm)	vc (m/min)	f (mm/rev)	ap (mm)	vc (m/min)	f (mm/rev)	ap (mm)	vc (m/min)	f (mm/rev)	ap (mm)	vc (m/min)	f (mm/rev)	ap (mm)	vc (m/min)	f (mm/rev)	ap (mm)



PCD tipped for finish to semi-rough machining, high speeds and stable cutting conditions.

VCMW 160404FN:PD1	● 0.4	-	-	-	-	-	-	-	-	■ 900	0.12	0.5	-	-	-	-	-	-
VCMW 160408FN:PD1	● 0.8	-	-	-	-	-	-	-	-	■ 1050	0.12	1.0	-	-	-	-	-	-

CCGW CBN



	IC (mm)	D1 (mm)	L (mm)	S (mm)
0602	6.350	2.80	6.50	2.38
09T3	9.525	4.50	9.70	3.97

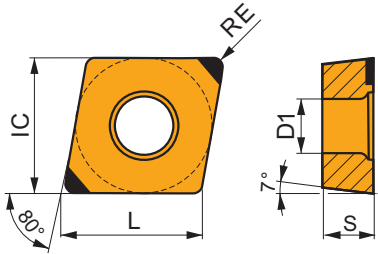

Suitability and starting values for cutting speed (vc), feed (f) and depth of cut (ap). Refer to our Machining Calculator app for further calculations.

Product	RE (mm)	P			M			K			N			S			H		
		vc (m/min)	f (mm/rev)	ap (mm)	vc (m/min)	f (mm/rev)	ap (mm)	vc (m/min)	f (mm/rev)	ap (mm)	vc (m/min)	f (mm/rev)	ap (mm)	vc (m/min)	f (mm/rev)	ap (mm)	vc (m/min)	f (mm/rev)	ap (mm)



CBN for finish machining.

CCGW 060204E-B:TB310	● 0.4	-	-	-	-	-	-	■ 460	0.10	0.4	-	-	-	■ 120	0.07	0.3	■ 95	0.07	0.3
CCGW 09T304E-B:TB310	● 0.4	-	-	-	-	-	-	■ 460	0.10	0.4	-	-	-	■ 120	0.07	0.3	■ 95	0.07	0.3



CBN for finish machining.

CCGW 060204S01020B:TB310	● 0.4	-	-	-	-	-	-	■ 460	0.10	0.4	-	-	-	■ 120	0.07	0.3	■ 95	0.07	0.3
CCGW 09T304S01020B:TB310	● 0.4	-	-	-	-	-	-	■ 460	0.10	0.4	-	-	-	■ 120	0.07	0.3	■ 95	0.07	0.3

CNGA CBN



	IC (mm)	D1 (mm)	L (mm)	S (mm)
1204	12.700	5.16	12.90	4.76

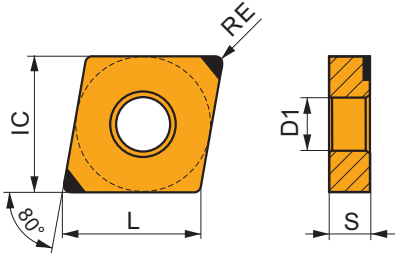

Suitability and starting values for cutting speed (vc), feed (f) and depth of cut (ap). Refer to our Machining Calculator app for further calculations.

Product	RE (mm)	P			M			K			N			S			H		
		vc (m/min)	f (mm/rev)	ap (mm)	vc (m/min)	f (mm/rev)	ap (mm)	vc (m/min)	f (mm/rev)	ap (mm)	vc (m/min)	f (mm/rev)	ap (mm)	vc (m/min)	f (mm/rev)	ap (mm)	vc (m/min)	f (mm/rev)	ap (mm)

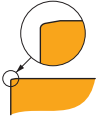

CBN for finish machining and continuous cuts.

CNGA 120404S01020B:TB310	● 0.4	-	-	-	-	-	-	▣ 510	0.10	0.4	-	-	-	▣ 135	0.07	0.3	■ 105	0.07	0.3
CNGA 120408S01020B:TB310	● 0.8	-	-	-	-	-	-	▣ 530	0.15	0.6	-	-	-	▣ 140	0.11	0.5	■ 110	0.08	0.7

DCGW CBN



	IC (mm)	D1 (mm)	L (mm)	S (mm)
11T3	9.525	4.50	11.60	3.97

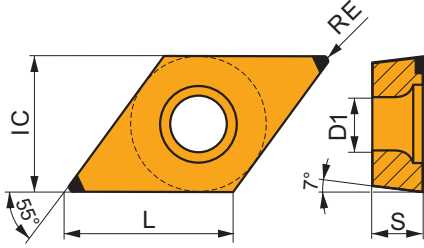

Suitability and starting values for cutting speed (vc), feed (f) and depth of cut (ap). Refer to our Machining Calculator app for further calculations.

Product	RE (mm)	P			M			K			N			S			H		
		vc (m/min)	f (mm/rev)	ap (mm)	vc (m/min)	f (mm/rev)	ap (mm)	vc (m/min)	f (mm/rev)	ap (mm)	vc (m/min)	f (mm/rev)	ap (mm)	vc (m/min)	f (mm/rev)	ap (mm)	vc (m/min)	f (mm/rev)	ap (mm)



CBN for finish machining.

DCGW 11T304S01020B:TB310	● 0.4	-	-	-	-	-	-	▣ 370	0.10	0.4	-	-	-	▣ 95	0.07	0.3	■ 75	0.07	0.3
DCGW 11T308S01020B:TB310	● 0.8	-	-	-	-	-	-	▣ 380	0.15	0.6	-	-	-	▣ 100	0.11	0.5	■ 80	0.08	0.7

TNGA CBN



	IC (mm)	D1 (mm)	L (mm)	S (mm)
1604	9.525	3.81	16.50	4.76

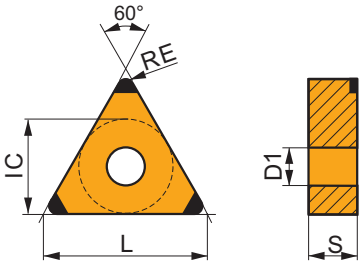

Suitability and starting values for cutting speed (vc), feed (f) and depth of cut (ap). Refer to our Machining Calculator app for further calculations.

Product	RE (mm)	P			M			K			N			S			H		
		vc (m/min)	f (mm/rev)	ap (mm)	vc (m/min)	f (mm/rev)	ap (mm)	vc (m/min)	f (mm/rev)	ap (mm)	vc (m/min)	f (mm/rev)	ap (mm)	vc (m/min)	f (mm/rev)	ap (mm)	vc (m/min)	f (mm/rev)	ap (mm)

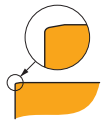

CBN for finish machining and continuous cuts.

TNGA 160408S01020C:TB310	● 0.8	-	-	-	-	-	-	▣ 450	0.15	0.6	-	-	-	▣ 115	0.11	0.5	■ 95	0.08	0.7
---------------------------------	-------	---	---	---	---	---	---	-------	------	-----	---	---	---	-------	------	-----	------	------	-----

VBGW CBN



	IC (mm)	D1 (mm)	L (mm)	S (mm)
1604	9.525	4.50	16.00	4.76

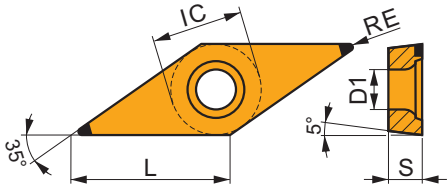

Suitability and starting values for cutting speed (vc), feed (f) and depth of cut (ap). Refer to our Machining Calculator app for further calculations.

Product	RE (mm)	P			M			K			N			S			H		
		vc (m/min)	f (mm/rev)	ap (mm)	vc (m/min)	f (mm/rev)	ap (mm)	vc (m/min)	f (mm/rev)	ap (mm)	vc (m/min)	f (mm/rev)	ap (mm)	vc (m/min)	f (mm/rev)	ap (mm)	vc (m/min)	f (mm/rev)	ap (mm)



CBN for finish machining and continuous cuts.

VBGW 160404S01020B:TB310	● 0.4	-	-	-	-	-	-	▣ 340	0.10	0.4	-	-	-	▣ 90	0.07	0.3	■ 70	0.07	0.3
VBGW 160408S01020B:TB310	● 0.8	-	-	-	-	-	-	▣ 350	0.15	0.6	-	-	-	▣ 90	0.11	0.5	■ 70	0.08	0.7

VNGA CBN



	IC (mm)	D1 (mm)	L (mm)	S (mm)
1604	9.525	3.81	16.00	4.76

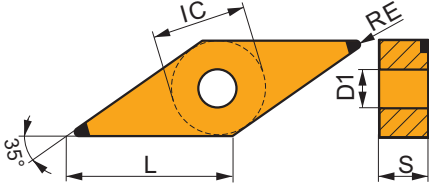

Suitability and starting values for cutting speed (vc), feed (f) and depth of cut (ap). Refer to our Machining Calculator app for further calculations.

Product	RE (mm)	P			M			K			N			S			H		
		vc (m/min)	f (mm/rev)	ap (mm)	vc (m/min)	f (mm/rev)	ap (mm)	vc (m/min)	f (mm/rev)	ap (mm)	vc (m/min)	f (mm/rev)	ap (mm)	vc (m/min)	f (mm/rev)	ap (mm)	vc (m/min)	f (mm/rev)	ap (mm)



CBN for finish machining and continuous cuts.

VNGA 160404S01020B:TB310	● 0.4	-	-	-	-	-	-	▣ 360	0.10	0.4	-	-	-	▣ 95	0.07	0.3	▣ 75	0.07	0.3
VNGA 160408S01020B:TB310	● 0.8	-	-	-	-	-	-	▣ 370	0.15	0.6	-	-	-	▣ 95	0.11	0.5	▣ 75	0.08	0.7

WNGA CBN



	IC (mm)	D1 (mm)	L (mm)	S (mm)
0804	12.700	5.16	8.70	4.76

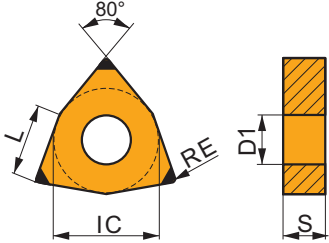

Suitability and starting values for cutting speed (vc), feed (f) and depth of cut (ap). Refer to our Machining Calculator app for further calculations.

Product	RE (mm)	P			M			K			N			S			H		
		vc (m/min)	f (mm/rev)	ap (mm)	vc (m/min)	f (mm/rev)	ap (mm)	vc (m/min)	f (mm/rev)	ap (mm)	vc (m/min)	f (mm/rev)	ap (mm)	vc (m/min)	f (mm/rev)	ap (mm)	vc (m/min)	f (mm/rev)	ap (mm)

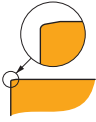
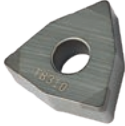

CBN for finish machining and continuous cuts.

WNGA 080408S01020C:TB310	● 0.8	-	-	-	-	-	-	▣ 530	0.15	0.6	-	-	-	▣ 140	0.11	0.5	▣ 110	0.08	0.7
--------------------------	-------	---	---	---	---	---	---	-------	------	-----	---	---	---	-------	------	-----	-------	------	-----

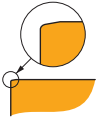
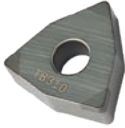

CBN for finish machining and continuous cuts.

WNGA080408S01020WC:TB310	- 0.8	-	-	-	-	-	-	▣ 530	0.15	0.6	-	-	-	▣ 140	0.11	0.5	▣ 110	0.08	0.7
--------------------------	-------	---	---	---	---	---	---	-------	------	-----	---	---	---	-------	------	-----	-------	------	-----

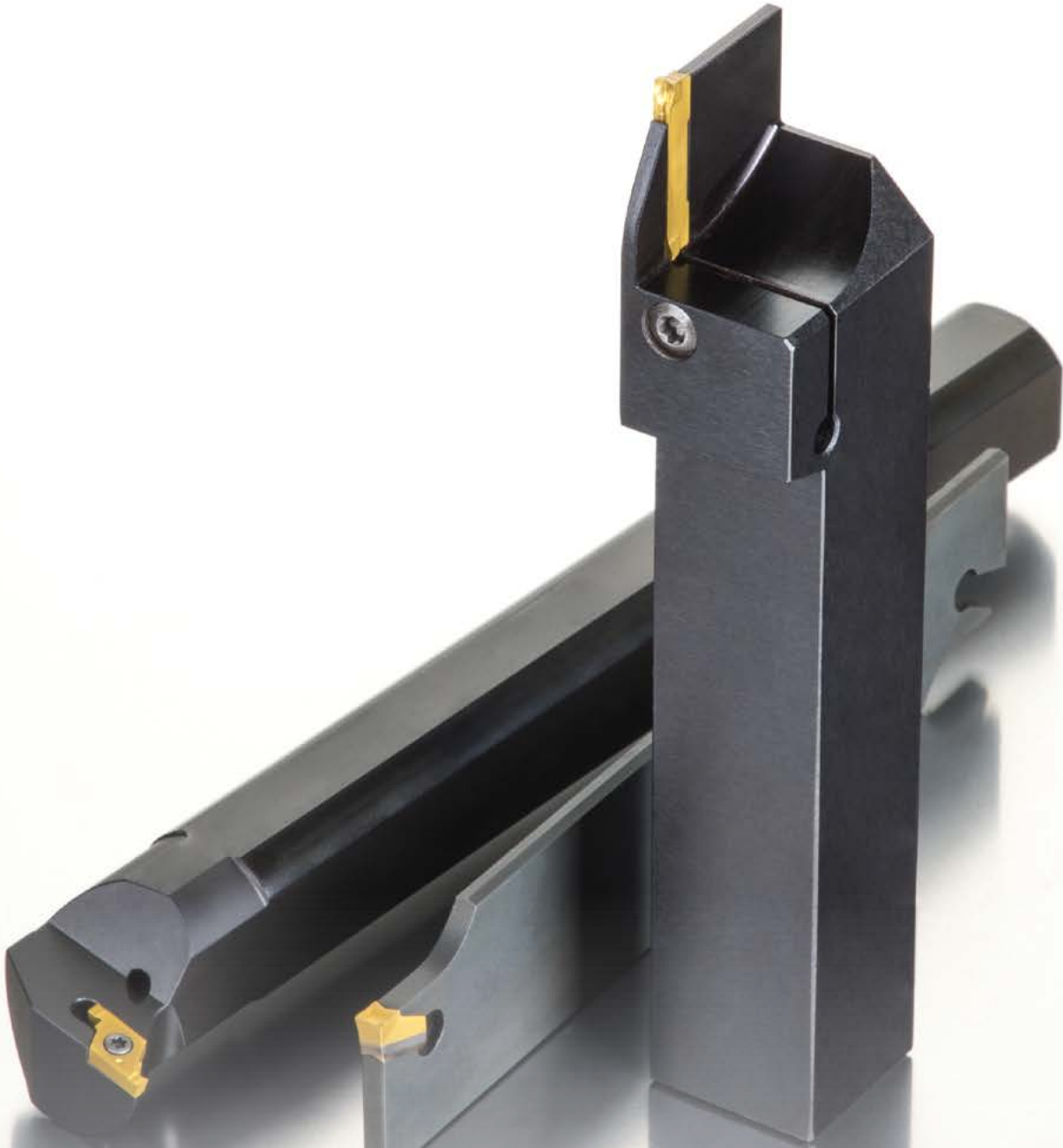

PARTING-OFF & GROOVING

GL – EXTERNAL TOOLS NAVIGATOR

INSERT SEAT	GL1	GL2	GL3	GL4	GL5	GL6	
NEW GLAF(RL)EXT 		COX 20 mm	COX 20 – 40 mm	COX 20 – 32 mm	COX 24 – 32 mm	COX 24 – 32 mm	
NEW GLAF(RL)EXT-S 		COX 12 – 16 mm	COX 12 – 16 mm	COX 16 mm			
GLSF(RL)EXT 	COX 16 mm NEW	COX 20 – 24 mm	COX 20 – 32 mm	COX 20 – 32 mm	COX 20 – 32 mm	COX 20 – 32 mm	
GLSF(RL)EXT-S 	COX 12 – 16 mm NEW	COX 12 – 16 mm	COX 12 – 16 mm	COX 16 mm			
GLSF(RL)EXT-G 		COX 10 mm	COX 10 – 20 mm	COX 12 – 24 mm	COX 12 – 32 mm	COX 12 – 32 mm	
Cutting width (mm)	1.5	2	3 (2.5)	4	5	6	8
NEW Deep parting-off (single sided insert) 			 SINGLE SIDED INSERT PM PR	 SINGLE SIDED INSERT PM PR			
Parting-off (tube / full bar) 	NEW PM	 PM PR	 CW = 2.5 / 3 PM PR	 PM PR	 PM PR	 PM PR	
Grooving (deep / shallow) 		 PR GM	 PR GM	 PR GM	 PR GM	 GM	NEW GM
Turning (longitudinal) 		 GM	 GM	 GM	 GM	 GM	NEW GM
Profiling (multiaxial) 		 MM	 MM	 MM	 MM	 MM	

GLAF(RL) EXT



PRAMET

G



Grooving and Parting-Off tool with internal coolant for GL Inserts

External Right/Left handed tool holder with internal coolant for GL inserts. Suited for radial grooving, parting-off, turning and profiling applications. Reinforced body design for longer tool life and low vibrations. Body treated for longer tool life.

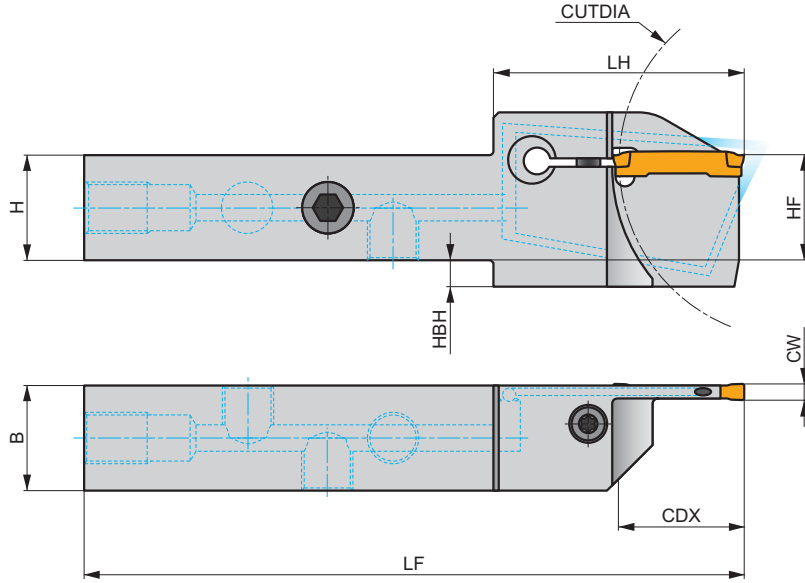
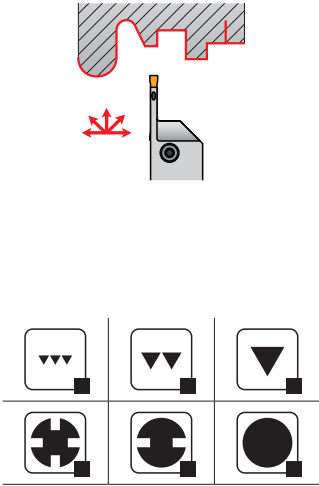

Product	HF	HBH	H	B	LF	LH	CW	CDX	CUTDIA	Handedness	kg	ISO	GL	CC
	(mm)	(mm)	(mm)	(mm)	(mm)	(mm)	(mm)	(mm)	(mm)					
R GL2-A2020KFR-20-80	20	5	20	20	125	43.5	2.00	20	80	✓	0.33	GI334	GL11	CC01
GL2-A2525MFR-20-80	25	-	25	25	150	43.5	2.00	20	80	✓	0.65	GI334	GL11	CC01
GL3-A2020KFR-20-80	20	5	20	20	125	43.5	3.00	20	80	✓	0.33	GI335	GL11	CC01
GL3-A2020KFR-24-80	20	5	20	20	125	47.5	3.00	24	80	✓	0.32	GI335	GL11	CC01
GL3-A2525MFR-20-80	25	-	25	25	150	43.5	3.00	20	80	✓	0.66	GI335	GL11	CC01
GL3-A2525PFR-32-80	25	5	25	25	170	55.5	3.00	32	80	✓	0.73	GI335	GL11	CC01
GL3-A2525PFR-40-100	25	7	25	25	170	63.5	3.00	40	100	✓	0.70	GI335	GL11	CC01
GL4-A2020KFR-20-80	20	5	20	20	125	43.6	4.00	20	80	✓	0.38	GI336	GL11	CC01
GL4-A2020KFR-24-80	20	5	20	20	125	47.6	4.00	24	80	✓	0.37	GI336	GL11	CC01
GL4-A2525MFR-20-80	25	-	25	25	150	43.6	4.00	20	80	✓	0.58	GI336	GL11	CC01
GL4-A2525PFR-32-80	25	5	25	25	170	55.6	4.00	32	80	✓	0.67	GI336	GL11	CC01
GL5-A2020KFR-24-80	20	5	20	20	125	47.6	5.00	24	80	✓	0.32	GI337	GL11	CC01
GL5-A2525PFR-32-100	25	5	25	25	170	55.6	5.00	32	100	✓	0.67	GI337	GL11	CC01
GL6-A2020KFR-24-80	20	5	20	20	125	47.6	6.00	24	80	✓	0.37	GI338	GL11	CC01
GL6-A2525PFR-32-100	25	5	25	25	170	55.6	6.00	32	100	✓	0.68	GI338	GL11	CC01
L GL2-A2020KFL-20-80	20	5	20	20	125	43.5	2.00	20	80	✓	0.33	GI334	GL11	CC01
GL2-A2525MFL-20-80	25	-	25	25	150	43.5	2.00	20	80	✓	0.66	GI334	GL11	CC01
GL3-A2020KFL-20-80	20	5	20	20	125	43.5	3.00	20	80	✓	0.33	GI335	GL11	CC01
GL3-A2020KFL-24-80	20	5	20	20	125	47.5	3.00	24	80	✓	0.36	GI335	GL11	CC01
GL3-A2525MFL-20-80	25	-	25	25	150	43.5	3.00	20	80	✓	0.65	GI335	GL11	CC01
GL3-A2525PFL-32-80	25	5	25	25	170	55.5	3.00	32	80	✓	0.67	GI335	GL11	CC01
GL3-A2525PFL-40-100	25	7	25	25	170	63.5	3.00	40	100	✓	0.70	GI335	GL11	CC01
GL4-A2020KFL-20-80	20	5	20	20	125	43.6	4.00	20	80	✓	0.33	GI336	GL11	CC01
GL4-A2020KFL-24-80	20	5	20	20	125	47.6	4.00	24	80	✓	0.37	GI336	GL11	CC01
GL4-A2525MFL-20-80	25	-	25	25	150	43.6	4.00	20	80	✓	0.65	GI336	GL11	CC01
GL4-A2525PFL-32-80	25	5	25	25	170	55.6	4.00	32	80	✓	0.73	GI336	GL11	CC01
GL5-A2020KFL-24-80	20	5	20	20	125	47.6	5.00	24	80	✓	0.32	GI337	GL11	CC01

Product	HF	HBH	H	B	LF	LH	CW	CDX	CUTDIA					
	(mm)	(mm)	(mm)	(mm)	(mm)	(mm)	(mm)	(mm)	(mm)		kg			
L GL5-A2525PFL-32-100	25	5	25	25	170	55.6	5.00	32	100		0.67	GI337	GL11	CC01
GL6-A2020KFL-24-80	20	5	20	20	125	47.6	6.00	24	80		0.33	GI338	GL11	CC01
GL6-A2525PFL-32-100	25	5	25	25	170	55.6	6.00	32	100		0.68	GI338	GL11	CC01

GI334	GL2..	-
GI335	GL3..	-
GI336	GL4..	-
GI337	GL5..	-
GI338	GL6-D600..	GL6-D800..

Cutting depths on machined diameter on page 364.

GL11	US 5018-T20P	5.0	M 5	18.2	LKT20P

CC01	CHP-P1/8	G1/8"	HXK 4

Coolant accessories can be found on page 366.

GLAF(RL) EXT-S

P
M
K
N
S
H

PRAMET

G



Grooving tool with internal coolant for GL Inserts, for Sliding head machines
 External Right/Left handed tool holder with internal coolant for GL inserts, designed for sliding head machines and easy access to insert clamping. Suited for radial grooving, parting-off, turning and profiling applications. Body treated for longer tool life.

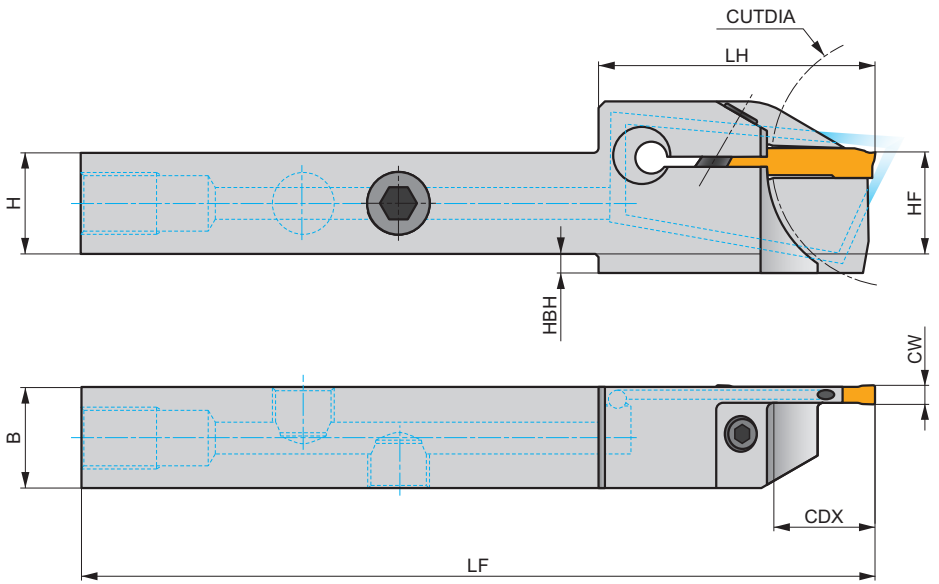
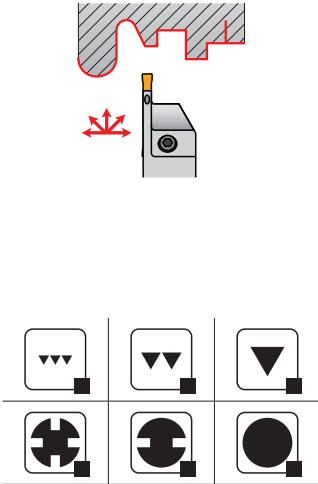

Product	HF	HBH	H	B	LF	LH	CW	CDX	CUTDIA	Hand	kg	G	L	CC	
	(mm)	(mm)	(mm)	(mm)	(mm)	(mm)	(mm)	(mm)	(mm)						
R	GL2-A1212HFR-12-40	12	3	12	12	100	33.0	2.00	12	40	✓	0.12	GI334	GL13	CC02
	GL2-A1616KFR-16-45	16	3	16	16	125	43.5	2.00	16	45	✓	0.21	GI334	GL12	CC01
	GL3-A1212HFR-12-40	12	3	12	12	100	33.0	3.00	12	40	✓	0.12	GI335	GL13	CC02
	GL3-A1616KFR-16-45	16	3	16	16	125	43.5	3.00	16	45	✓	0.21	GI335	GL12	CC01
L	GL4-A1616KFR-16-45	16	4	16	16	125	43.6	4.00	16	45	✓	0.21	GI336	GL12	CC01
	GL2-A1212HFL-12-40	12	3	12	12	100	33.0	2.00	12	40	✓	0.11	GI334	GL13	CC02
	GL2-A1616KFL-16-45	16	3	16	16	125	43.5	2.00	16	45	✓	0.27	GI334	GL12	CC01
	GL3-A1212HFL-12-40	12	3	12	12	100	33.0	3.00	12	40	✓	0.12	GI335	GL13	CC02
	GL3-A1616KFL-16-45	16	3	16	16	125	43.5	3.00	16	45	✓	0.25	GI335	GL12	CC01
GL4-A1616KFL-16-45	16	4	16	16	125	43.6	4.00	16	45	✓	0.21	GI336	GL12	CC01	

GI334	GL2..
GI335	GL3..
GI336	GL4..

Cutting depths on machined diameter on page 364.

GL12	HS 0516	5.0	M 5	16	HXK 4
GL13	HS 0412	5.0	M 4	12	HXK 3

CC01	CHP-P1/8	-	G1/8"	HXK 4	-	-
CC02	-	CHP-P6	M6	HXK 3	CHP-G06	CHP-R1/8-6

Coolant accessories can be found on page 366.

GLSF(RL) EXT



PRAMET

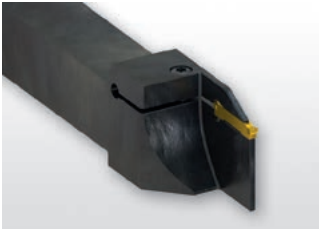

Grooving and Parting-Off tool for GL Inserts

External Right/Left handed tool holder for GL inserts. Suited for radial grooving, parting-off, turning and profiling applications. Reinforced body design for longer tool life and low vibrations. Body treated for longer tool life.

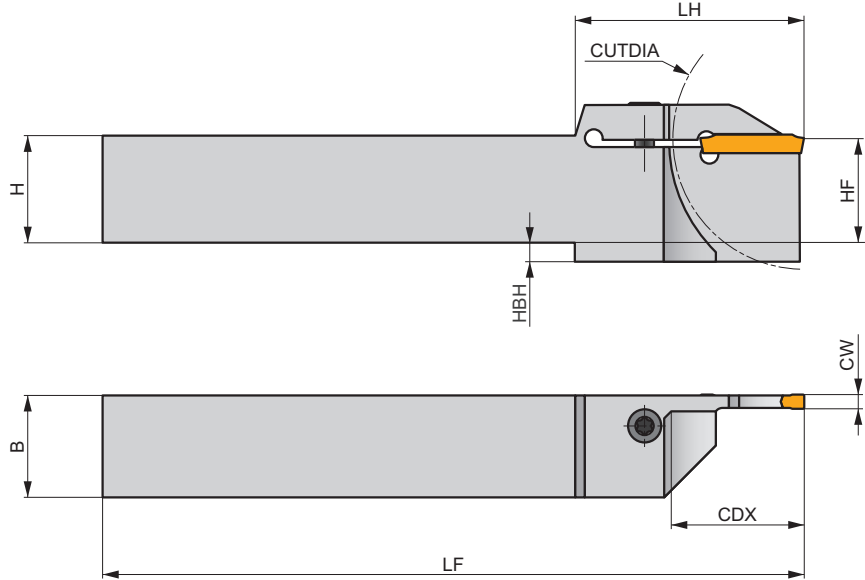
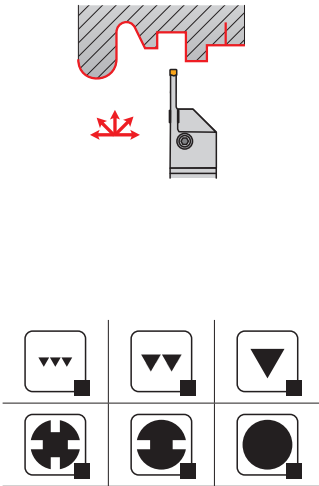

Product	⌀	HBH	H	B	LF	LH	CW	CDX	CUTDIA	kg			
	(mm)	(mm)	(mm)	(mm)	(mm)	(mm)	(mm)	(mm)	(mm)				
R	GL1-S2020KFR-16-60	20	–	20	20	125	34.2	1.50	16	60	0.35	GI333	GL11
	GL2-S2020KFR-20-80	20	–	20	20	125	43.5	2.00	20	80	0.38	GI334	GL11
	GL2-S2020KFR-24-80	20	5	20	20	125	48.5	2.00	24	80	0.38	GI334	GL11
	GL2-S2525MFR-20-80	25	–	25	25	150	43.5	2.00	20	80	0.70	GI334	GL11
	GL2-S2525MFR-24-80	25	–	25	25	150	47.5	2.00	24	80	0.68	GI334	GL11
	GL3-S2020KFR-20-80	20	–	20	20	125	43.5	3.00	20	80	0.38	GI335	GL11
	GL3-S2020KFR-24-80	20	5	20	20	125	47.5	3.00	24	80	0.36	GI335	GL11
	GL3-S2525MFR-20-80	25	–	25	25	150	43.5	3.00	20	80	0.70	GI335	GL11
	GL3-S2525MFR-24-80	25	–	25	25	150	47.5	3.00	24	80	0.65	GI335	GL11
	GL3-S2525PFR-32-80	25	5	25	25	170	55.5	3.00	32	80	0.78	GI335	GL11
	GL4-S2020KFR-20-80	20	–	20	20	125	43.5	4.00	20	80	0.38	GI336	GL11
	GL4-S2020KFR-24-80	20	5	20	20	125	47.5	4.00	24	80	0.37	GI336	GL11
	GL4-S2525MFR-20-80	25	–	25	25	150	43.5	4.00	20	80	0.68	GI336	GL11
	GL4-S2525MFR-24-80	25	–	25	25	150	47.5	4.00	24	80	0.69	GI336	GL11
	GL4-S2525PFR-32-80	25	5	25	25	170	55.5	4.00	32	80	0.78	GI336	GL11
	GL5-S2020KFR-20-80	20	–	20	20	125	43.5	5.00	20	80	0.38	GI337	GL11
	GL5-S2525MFR-20-80	25	–	25	25	150	43.5	5.00	20	80	0.68	GI337	GL11
	GL5-S2525PFR-32-100	25	5	25	25	170	55.5	5.00	32	100	0.78	GI337	GL11
GL6-S2020KFR-20-80	20	–	20	20	125	43.5	6.00	20	80	0.39	GI338-1	GL11	
GL6-S2525MFR-20-80	25	–	25	25	150	43.5	6.00	20	80	0.68	GI338-1	GL11	
GL6-S2525PFR-32-100	25	5	25	25	170	55.5	6.00	32	100	0.75	GI338	GL11	
L	GL1-S2020KFL-16-60	20	–	20	20	125	34.2	1.50	16	60	0.35	GI333	GL11
	GL2-S2020KFL-20-80	20	–	20	20	125	43.5	2.00	20	80	0.38	GI334	GL11
	GL2-S2020KFL-24-80	20	5	20	20	125	47.5	2.00	24	80	0.39	GI334	GL11
	GL2-S2525MFL-20-80	25	–	25	25	150	43.5	2.00	20	80	0.70	GI334	GL11
	GL2-S2525MFL-24-80	25	–	25	25	150	47.5	2.00	24	80	0.64	GI334	GL11
	GL3-S2020KFL-20-80	20	–	20	20	125	43.5	3.00	20	80	0.38	GI335	GL11

Product	HF	HBH	H	B	LF	LH	CW	CDX	CUTDIA	kg		
	(mm)	(mm)	(mm)	(mm)	(mm)	(mm)	(mm)	(mm)	(mm)			
GL3-S2020KFL-24-80	20	5	20	20	125	47.5	3.00	24	80	0.39	GI335	GL11
GL3-S2525MFL-20-80	25	–	25	25	150	43.5	3.00	20	80	0.68	GI335	GL11
GL3-S2525PFL-24-80	25	–	25	25	150	47.5	3.00	24	80	0.68	GI335	GL11
GL3-S2525PFL-32-80	25	5	25	25	170	55.5	3.00	32	80	0.78	GI335	GL11
GL4-S2020KFL-20-80	20	–	20	20	125	43.5	4.00	20	80	0.38	GI336	GL11
GL4-S2020KFL-24-80	20	5	20	20	125	47.5	4.00	24	80	0.39	GI336	GL11
GL4-S2525MFL-20-80	25	–	25	25	150	43.5	4.00	20	80	0.68	GI336	GL11
L GL4-S2525MFL-24-80	25	–	25	25	150	47.5	4.00	24	80	0.65	GI336	GL11
GL4-S2525PFL-32-80	25	5	25	25	170	55.5	4.00	32	80	0.78	GI336	GL11
GL5-S2020KFL-20-80	20	–	20	20	125	43.5	5.00	20	80	0.38	GI337	GL11
GL5-S2525MFL-20-80	25	–	25	25	150	43.5	5.00	20	80	0.71	GI337	GL11
GL5-S2525PFL-32-100	25	5	25	25	170	55.5	5.00	32	100	0.78	GI337	GL11
GL6-S2020KFL-20-80	20	–	20	20	125	43.5	6.00	20	80	0.39	GI338-1	GL11
GL6-S2525MFL-20-80	25	–	25	25	150	43.5	6.00	20	80	0.71	GI338-1	GL11
GL6-S2525PFL-32-100	25	5	25	25	170	55.5	6.00	32	100	0.75	GI338	GL11

GI333	GL1..	–
GI334	GL2..	–
GI335	GL3..	–
GI336	GL4..	–
GI337	GL5..	–
GI338	GL6-D600..	GL6-D800..
GI338-1	GL6-D600..	–

Cutting depths on machined diameter on page 364.

GL11	US 5018-T20P	5.0	M 5	18.2	LKT20P

GLSF(RL) EXT-S



PRAMET



Grooving and Parting-Off tool for GL Inserts, for Sliding head machines

External Right/Left handed tool holder for GL inserts, designed for sliding head machines and easy access to insert clamping. Suited for radial grooving, parting-off, turning and profiling applications. Body treated for longer tool life.

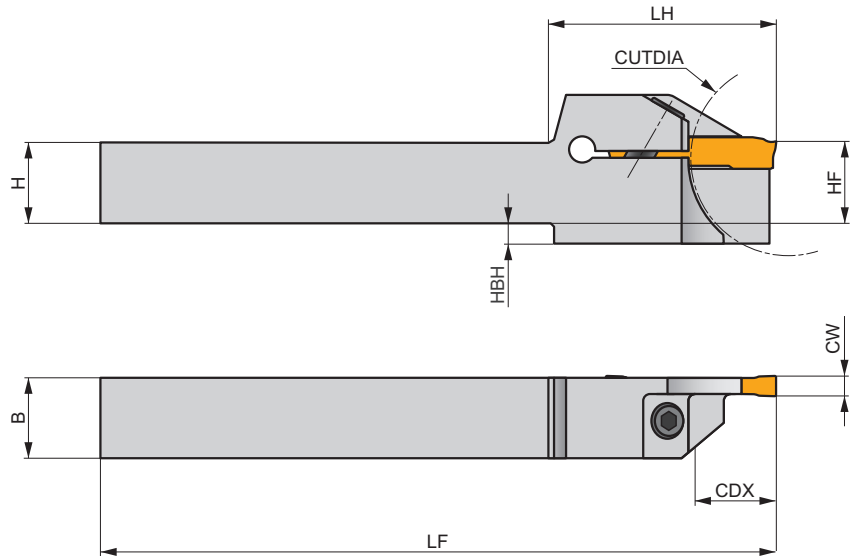
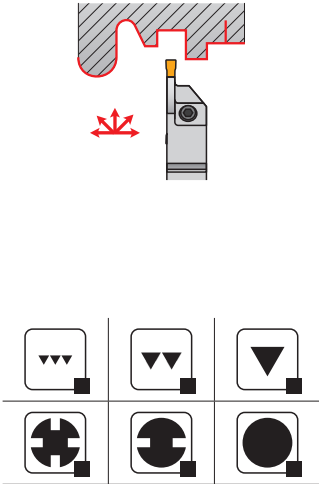

Product	HF	HBH	H	B	LF	LH	CW	CDX	CUTDIA	kg	G1333	G1334	
	(mm)	(mm)	(mm)	(mm)	(mm)	(mm)	(mm)	(mm)	(mm)				
R	GL1-S1212HFR-12-40	12	-	12	12	100	30.2	1.50	12	40	0.10	G1333	GL13
	GL1-S1616KFR-16-45	16	-	16	16	125	34.2	1.50	16	45	0.23	G1333	GL12
	GL2-S1212HFR-12-40	12	3	12	12	100	33.0	2.00	12	40	0.14	G1334	GL13
	GL2-S1616KFR-16-45	16	3	16	16	125	39.5	2.00	16	45	0.23	G1334	GL12
	GL3-S1212HFR-12-40	12	3	12	12	100	33.0	3.00	12	40	0.11	G1335	GL13
	GL3-S1616KFR-16-45	16	3	16	16	125	39.5	3.00	16	45	0.23	G1335	GL12
L	GL4-S1616KFR-16-45	16	4	16	16	125	39.5	4.00	16	45	0.28	G1336	GL12
	GL1-S1212HFL-12-40	12	-	12	12	100	30.2	1.50	12	40	0.10	G1333	GL13
	GL1-S1616KFL-16-45	16	-	16	16	125	34.2	1.50	16	45	0.23	G1333	GL12
	GL2-S1212HFL-12-40	12	3	12	12	100	33.0	2.00	12	40	0.11	G1334	GL13
	GL2-S1616KFL-16-45	16	3	16	16	125	39.5	2.00	16	45	0.23	G1334	GL12
	GL3-S1212HFL-12-40	12	3	12	12	100	33.0	3.00	12	40	0.11	G1335	GL13
GL3-S1616KFL-16-45	16	3	16	16	125	39.5	3.00	16	45	0.23	G1335	GL12	
GL4-S1616KFL-16-45	16	4	16	16	125	39.5	4.00	16	45	0.24	G1336	GL12	

Product	Insert
G1333	GL1..
G1334	GL2..
G1335	GL3..
G1336	GL4..

Cutting depths on machined diameter on page 364.

Product	HS	Nm	M	HF	HXX
GL12	HS 0516	5.0	M 5	16	HXX 4
GL13	HS 0412	5.0	M 4	12	HXX 3

GLSF(RL) EXT-G



PRAMET





Grooving and Turning tool for GL Inserts

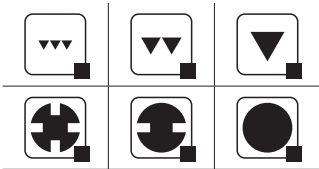
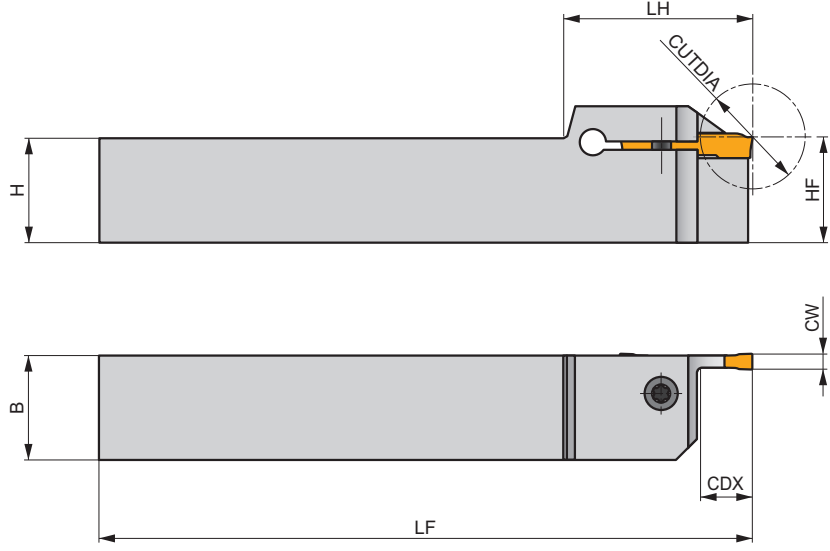
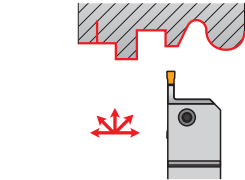





External Right/Left handed tool holder for GL inserts. Best suited for longitudinal turning and profiling applications, usable also for grooving and parting-off. Body treated for longer tool life.



Product	⌀	H	B	⌀	H	CW	CDX	CUTDIA	kg	G	S	
	(mm)	(mm)	(mm)	(mm)	(mm)	(mm)	(mm)	(mm)				
R	GL2-S2020KFR-10	20	20	20	125	36.0	2.00	10	20	0.38	G1334	GL11
	GL2-S2525MFR-10	25	25	25	150	36.0	2.00	10	20	0.69	G1334	GL11
	GL3-S2020KFR-10	20	20	20	125	36.0	3.00	10	20	0.39	G1335	GL11
	GL3-S2525MFR-10	25	25	25	150	36.0	3.00	10	20	0.73	G1335	GL11
	GL3-S3232MFR-20	32	32	32	150	46.0	3.00	20	40	1.12	G1335	GL15
	GL4-S2020KFR-12	20	20	20	125	36.0	4.00	12	24	0.37	G1336	GL11
	GL4-S2525MFR-12	25	25	25	150	36.0	4.00	12	24	0.69	G1336	GL11
	GL4-S3232MFR-24	32	32	32	150	50.0	4.00	24	48	1.04	G1336	GL15
	GL5-S2020KFR-12	20	20	20	125	36.0	5.00	12	24	0.36	G1337	GL11
	GL5-S2525MFR-12	25	25	25	150	36.0	5.00	12	24	0.72	G1337	GL11
	GL5-S3232PFR-32	32	32	32	170	58.0	5.00	32	64	1.21	G1337	GL15
	GL6-S2020KFR-12	20	20	20	125	36.0	6.00	12	24	0.36	G1338-1	GL11
	GL6-S2525MFR-12	25	25	25	150	36.0	6.00	12	24	0.68	G1338-1	GL11
	GL6-S3232PFR-32	32	32	32	170	58.0	6.00	32	64	1.22	G1338	GL15
	L	GL2-S2020KFL-10	20	20	20	125	36.0	2.00	10	20	0.37	G1334
GL2-S2525MFL-10		25	25	25	150	36.0	2.00	10	20	0.70	G1334	GL11
GL3-S2020KFL-10		20	20	20	125	36.0	3.00	10	20	0.36	G1335	GL11
GL3-S2525MFL-10		25	25	25	150	36.0	3.00	10	20	0.70	G1335	GL11
GL3-S3232MFL-20		32	32	32	150	46.0	3.00	20	40	1.12	G1335	GL15
GL4-S2020KFL-12		20	20	20	125	36.0	4.00	12	24	0.37	G1336	GL11
GL4-S2525MFL-12		25	25	25	150	36.0	4.00	12	24	0.69	G1336	GL11
GL4-S3232MFL-24		32	32	32	150	50.0	4.00	24	48	1.04	G1336	GL15
GL5-S2020KFL-12		20	20	20	125	36.0	5.00	12	24	0.36	G1337	GL11
GL5-S2525MFL-12		25	25	25	150	36.0	5.00	12	24	0.72	G1337	GL11
GL5-S3232PFL-32		32	32	32	170	58.0	5.00	32	64	1.15	G1337	GL15
GL6-S2020KFL-12		20	20	20	125	36.0	6.00	12	24	0.36	G1338-1	GL11
GL6-S2525MFL-12		25	25	25	150	36.0	6.00	12	24	0.72	G1338-1	GL11

Product	HF	H	B	LF	LH	CW	CDX	CUTD/A	kg		
	(mm)	(mm)	(mm)	(mm)	(mm)	(mm)	(mm)	(mm)			
L GL6-S3232PFL-32	32	32	32	170	58.0	6.00	32	64	1.15	GI338	GL15

		
GI334	GL2..	-
GI335	GL3..	-
GI336	GL4..	-
GI337	GL5..	-
GI338	GL6-D600..	GL6-D800..
GI338-1	GL6-D600..	-

					
GL11	US 5018-T20P	5.0	M 5	18.2	LKT20P
GL15	SR 88026-T30P	5.0	M8	26	LKT30P

CUTTING DEPTHS DEPENDING ON MACHINED DIAMETER

GLAF(RL) EXT

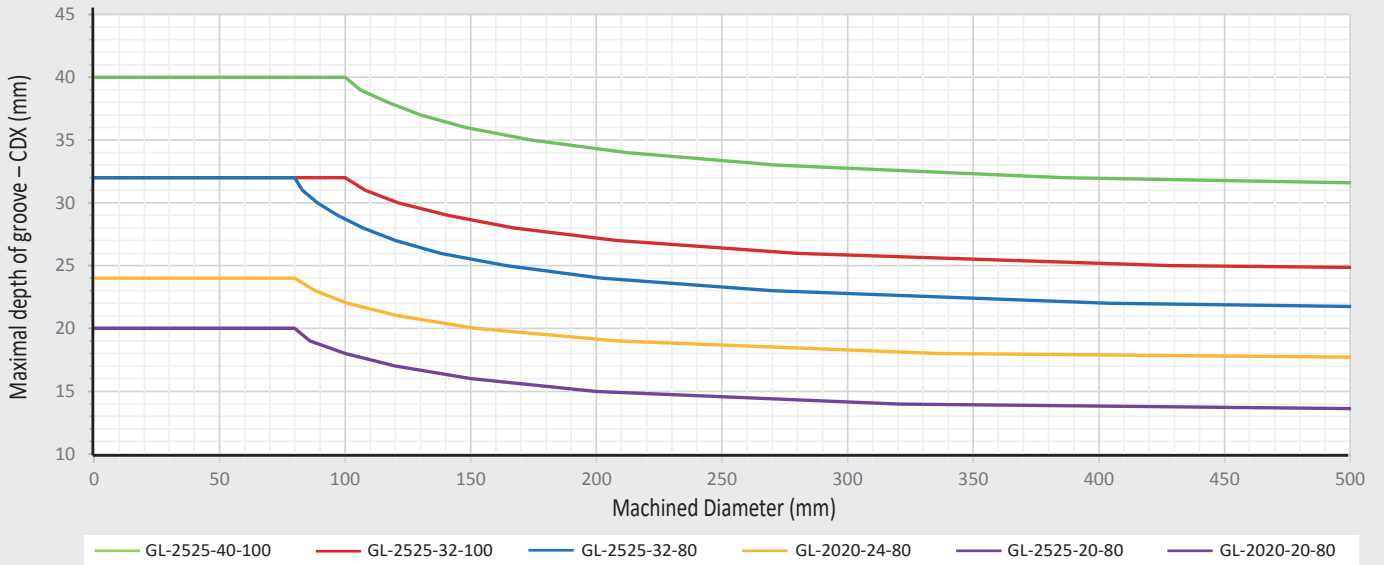

GLAF(RL) EXT-S

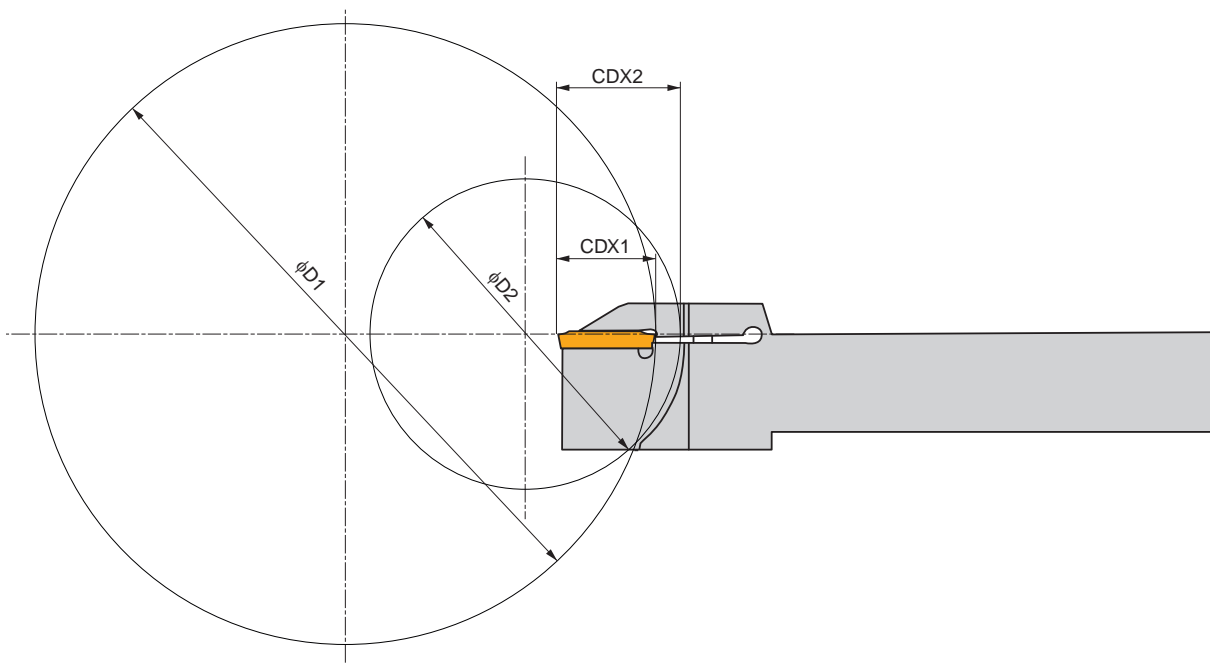
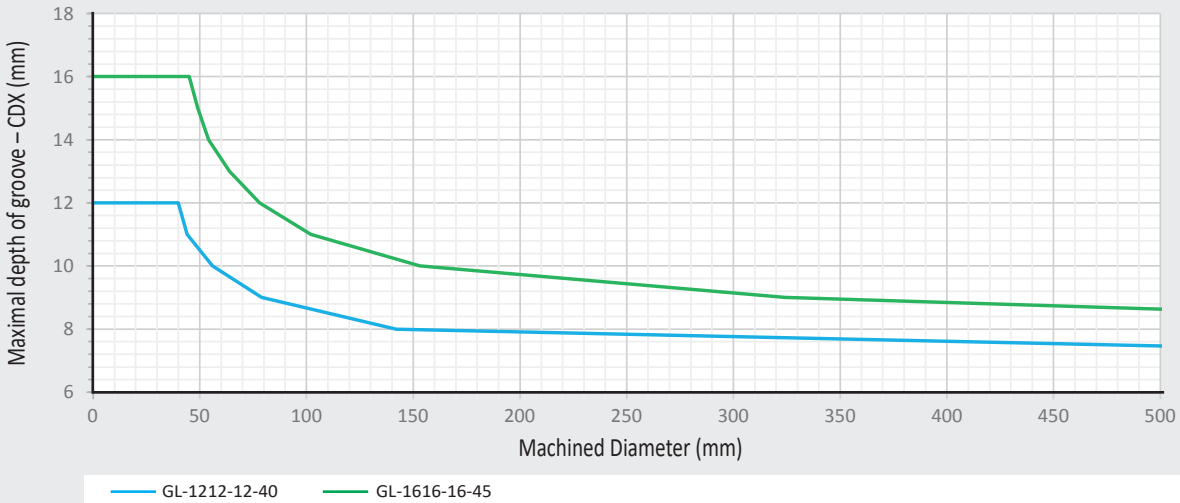

CUTTING DEPTHS DEPENDING ON MACHINED DIAMETER

GLSF (RL) EXT

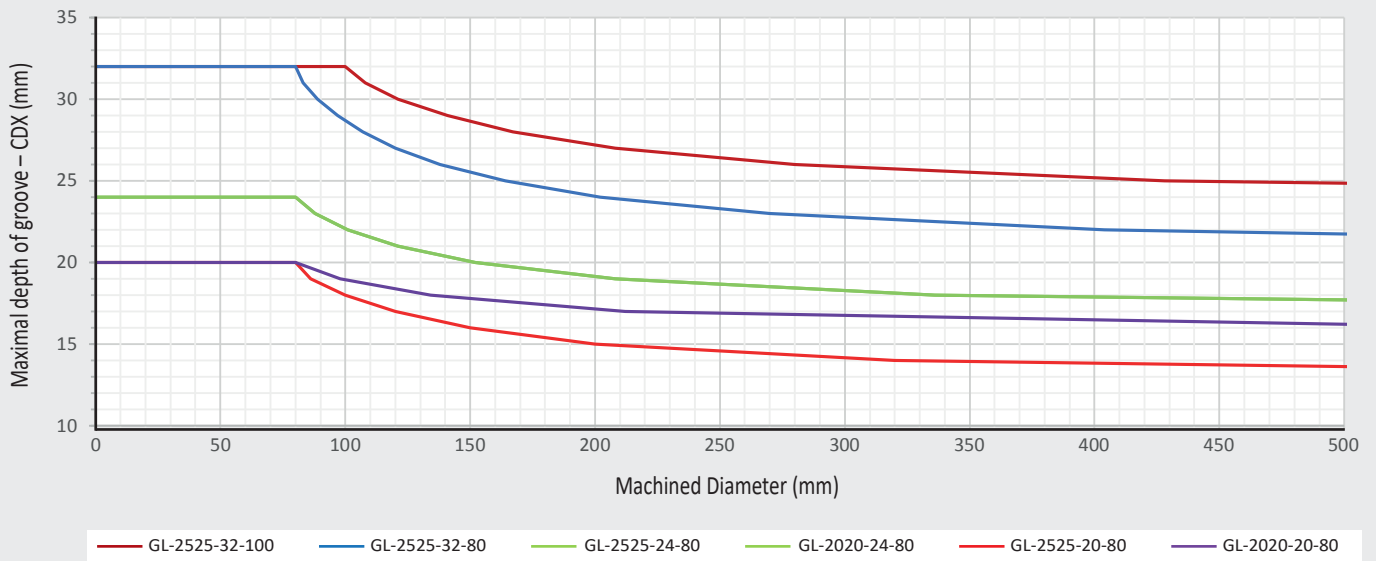

GLSF (RL) EXT-S

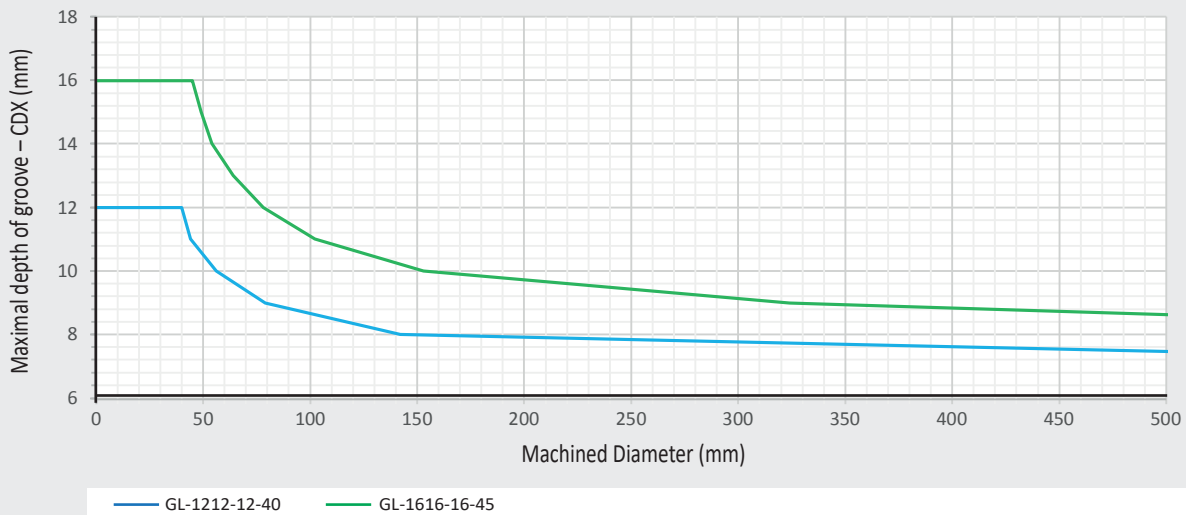

GL1

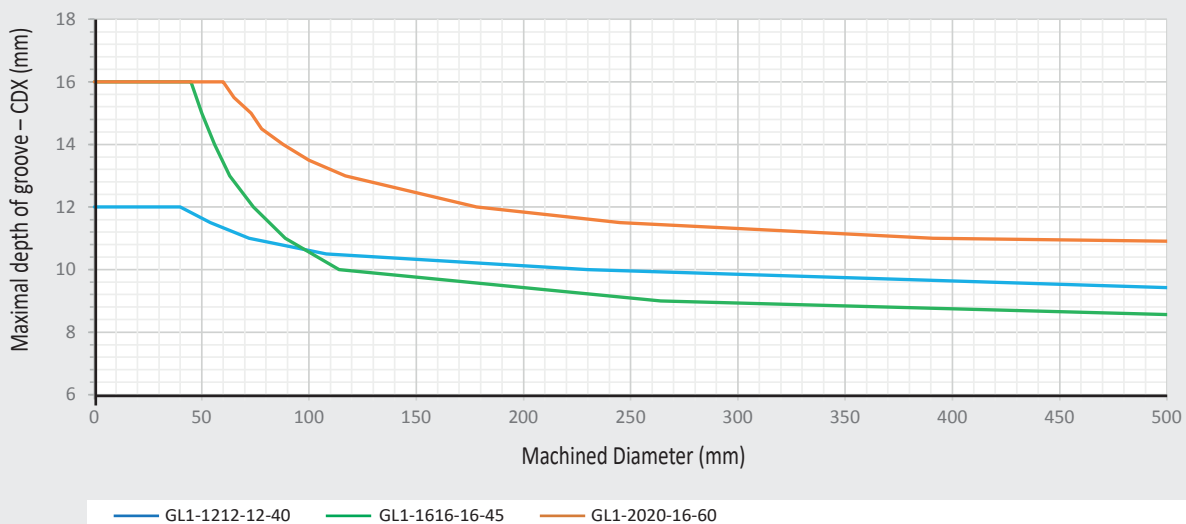

HOSE SET

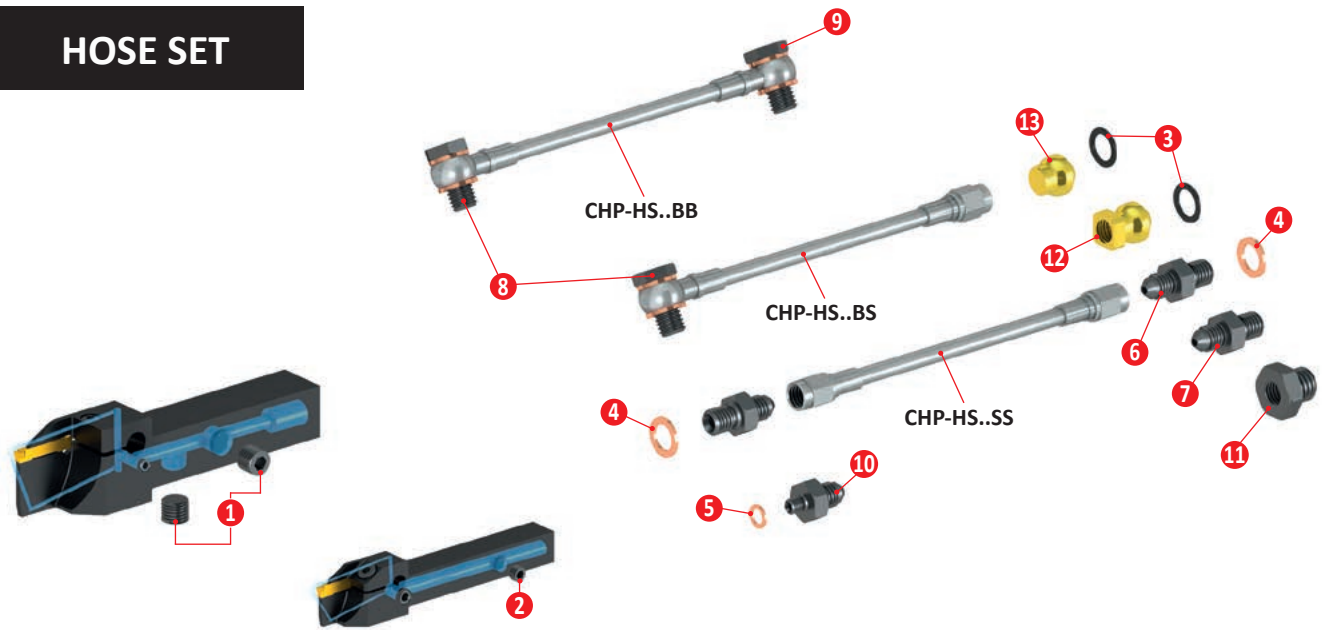

length			
	150 mm	CHP-HS150 SS	CHP-HS150 BS
250 mm	CHP-HS250 SS	CHP-HS250 BS	CHP-HS250 BB
300 mm	CHP-HS300 SS	CHP-HS300 BS	CHP-HS300 BB

		Designation			
1		Plug G $\frac{1}{8}$ "	CHP-P1/8	1 x	1 x
2		Plug 6*	CHP-P6	–	–
3		O-ring	CHP-O10×1	2 x	2 x
4		Copper gasket	CHP-G10	2 x	3 x
5		Copper gasket*	CHP-G06	–	–
6		Conector straight G $\frac{1}{8}$ "	CHP-CS1/8	2 x	1 x
7		Conector straight M10	CHP-CS10	1 x	–
8		Conector banjo G $\frac{1}{8}$ "	CHP-CB1/8	–	1 x
9		Conector banjo M10	CHP-CB10	–	1 x
10		Reduction G $\frac{1}{8}$ " to M6*	CHP-R1/8-6	–	–
11		Reduction G $\frac{1}{4}$ " to G $\frac{1}{8}$ "	CHP-R1/4-1/8	–	1 x
12		Coolant nozzle G $\frac{1}{8}$ "	CHP-PV1/8-12	1 x	1 x
13		Coolant nozzle plug	CHP-PV14	1 x	1 x

* included in tool shank 12 × 12 delivery

GL. D - PM



	CW (mm)	CWTOLL (mm)	CWTOLU (mm)	INSL (mm)
150	1.50	-0.04	0.04	16.5
200	2.00	-0.05	0.05	25.0
250	2.55	-0.05	0.05	25.0
300	3.00	-0.05	0.05	25.0
400	4.00	-0.05	0.05	25.0
500	5.00	-0.05	0.05	25.0
600	6.00	-0.05	0.05	25.0

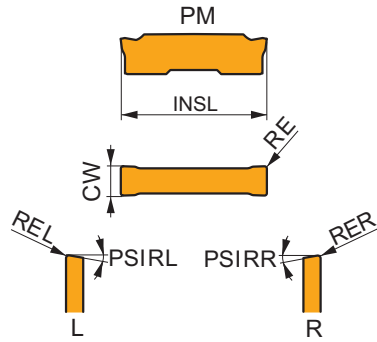

Suitability and starting values for cutting speed (vc) and feed (f). Refer to our Machining Calculator app for further calculations.

Product	RE (mm)	P		M		K		N		S		H		PSIRR (°)	PSIRL (°)
		vc (m/min)	f (mm/rev)	vc (m/min)	f (mm/rev)	vc (m/min)	f (mm/rev)	vc (m/min)	f (mm/rev)	vc (m/min)	f (mm/rev)	vc (m/min)	f (mm/rev)		

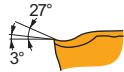

PM geometry with highly positive rake, first choice for parting-off, and continuous to slightly interrupted cuts.

GL1-D150M015-PM:G8330	●	0.1	130	0.05	75	0.05	120	0.05	390	0.06	30	0.04	-	-	-	-
GL2-D200M02-PM:G8330	●	0.2	130	0.08	75	0.07	120	0.08	390	0.10	30	0.06	-	-	-	-
GL2-D200M02-PM:T7325	●	0.2	150	0.08	115	0.07	140	0.08	-	-	45	0.06	-	-	-	-
GL3-D250G02-PM:G8330	●	0.2	130	0.10	75	0.09	120	0.10	390	0.12	30	0.07	-	-	-	-
GL3-D300M02-PM:G8330	●	0.2	130	0.10	75	0.09	120	0.10	390	0.12	30	0.07	-	-	-	-
GL3-D300M02-PM:T7325	●	0.2	150	0.10	115	0.09	140	0.10	-	-	45	0.07	-	-	-	-
GL4-D400M02-PM:G8330	●	0.2	130	0.12	75	0.11	120	0.12	390	0.14	30	0.10	-	-	-	-
GL4-D400M02-PM:T7325	●	0.2	150	0.12	115	0.11	140	0.12	-	-	45	0.10	-	-	-	-
GL5-D500M03-PM:G8330	●	0.3	130	0.15	75	0.14	120	0.15	390	0.18	30	0.12	-	-	-	-
GL6-D600M03-PM:G8330	●	0.3	130	0.15	75	0.14	120	0.15	390	0.18	30	0.12	-	-	-	-

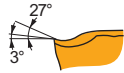

R-PM right-handed geometry with highly positive rake, first choice for tubes parting-off, and continuous cuts.

GL1-D150G015R06-PM:G8330	●	0.1	130	0.05	75	0.05	120	0.05	390	0.06	30	0.04	-	-	6	-
GL1-D150G015R12-PM:G8330	●	0.1	130	0.05	75	0.05	120	0.05	390	0.06	30	0.04	-	-	12	-
GL2-D200G02R06-PM:G8330	●	0.2	130	0.08	75	0.07	120	0.08	390	0.10	30	0.06	-	-	6	-
GL2-D200G02R06-PM:T7325	●	0.2	150	0.08	115	0.07	140	0.08	-	-	45	0.06	-	-	6	-
GL2-D200G02R12-PM:G8330	●	0.2	130	0.08	75	0.07	120	0.08	390	0.10	30	0.06	-	-	12	-
GL3-D300G02R06-PM:G8330	●	0.2	130	0.10	75	0.09	120	0.10	390	0.12	30	0.07	-	-	6	-
GL3-D300G02R06-PM:T7325	●	0.2	150	0.10	115	0.09	140	0.10	-	-	45	0.07	-	-	6	-
GL3-D300G02R12-PM:G8330	●	0.2	130	0.10	75	0.09	120	0.10	390	0.12	30	0.07	-	-	12	-
GL4-D400G02R06-PM:G8330	●	0.2	130	0.12	75	0.11	120	0.12	390	0.14	30	0.10	-	-	6	-
GL4-D400G02R06-PM:T7325	●	0.2	150	0.12	115	0.11	140	0.12	-	-	45	0.10	-	-	6	-
GL4-D400G02R12-PM:G8330	●	0.2	130	0.12	75	0.11	120	0.12	390	0.14	30	0.10	-	-	12	-

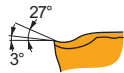

L-PM left-handed geometry with highly positive rake, first choice for tubes parting-off, and continuous cuts.

GL1-D150G015L06-PM:G8330	●	0.1	130	0.05	75	0.05	120	0.05	390	0.06	30	0.04	-	-	-	6
GL1-D150G015L12-PM:G8330	●	0.1	130	0.05	75	0.05	120	0.05	390	0.06	30	0.04	-	-	-	12
GL2-D200G02L06-PM:G8330	●	0.2	130	0.08	75	0.07	120	0.08	390	0.10	30	0.06	-	-	-	6
GL2-D200G02L06-PM:T7325	●	0.2	150	0.08	115	0.07	140	0.08	-	-	45	0.06	-	-	-	6
GL2-D200G02L12-PM:G8330	●	0.2	130	0.08	75	0.07	120	0.08	390	0.10	30	0.06	-	-	-	12
GL3-D300G02L06-PM:G8330	●	0.2	130	0.10	75	0.09	120	0.10	390	0.12	30	0.07	-	-	-	6
GL3-D300G02L06-PM:T7325	●	0.2	150	0.10	115	0.09	140	0.10	-	-	45	0.07	-	-	-	6
GL3-D300G02L12-PM:G8330	●	0.2	130	0.10	75	0.09	120	0.10	390	0.12	30	0.07	-	-	-	12
GL4-D400G02L06-PM:G8330	●	0.2	130	0.12	75	0.11	120	0.12	390	0.14	30	0.10	-	-	-	6
GL4-D400G02L06-PM:T7325	●	0.2	150	0.12	115	0.11	140	0.12	-	-	45	0.10	-	-	-	6
GL4-D400G02L12-PM:G8330	●	0.2	130	0.12	75	0.11	120	0.12	390	0.14	30	0.10	-	-	-	12

GL. D - PR



	CW (mm)	CWTOLL (mm)	CWTOLU (mm)	INSL (mm)
200	2.00	-0.05	0.05	25.0
300	3.00	-0.05	0.05	25.0
400	4.00	-0.05	0.05	25.0
500	5.00	-0.05	0.05	25.0
600	6.00	-0.05	0.05	25.0

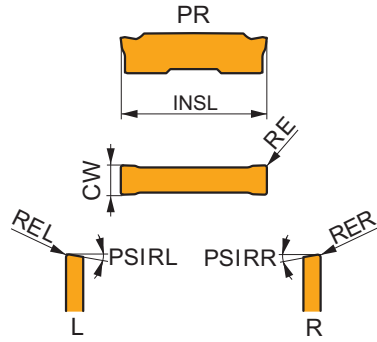

Suitability and starting values for cutting speed (vc) and feed (f). Refer to our Machining Calculator app for further calculations.

Product	RE (mm)	P		M		K		N		S		H		PSIRR (°)	PSIRL (°)
		vc (m/min)	f (mm/rev)	vc (m/min)	f (mm/rev)	vc (m/min)	f (mm/rev)	vc (m/min)	f (mm/rev)	vc (m/min)	f (mm/rev)	vc (m/min)	f (mm/rev)		

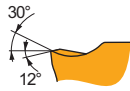

PR geometry with negative T-land, first choice for difficult grooving and parting-off, and continuous to interrupted cuts.

GL2-D200M02-PR:G8330	0.2	130	0.10	75	0.09	120	0.10	-	-	-	-	-	-	-	-
GL2-D200M02-PR:T7325	0.2	150	0.10	115	0.09	140	0.10	-	-	-	-	-	-	-	-
GL3-D300M02-PR:G8330	0.2	130	0.12	75	0.11	120	0.12	-	-	-	-	-	-	-	-
GL3-D300M02-PR:T7325	0.2	150	0.12	115	0.11	140	0.12	-	-	-	-	-	-	-	-
GL4-D400M02-PR:G8330	0.2	130	0.15	75	0.14	120	0.15	-	-	-	-	-	-	-	-
GL4-D400M02-PR:T7325	0.2	150	0.15	115	0.14	140	0.15	-	-	-	-	-	-	-	-
GL5-D500M04-PR:G8330	0.4	130	0.18	75	0.16	120	0.18	-	-	-	-	-	-	-	-
GL6-D600M04-PR:G8330	0.4	130	0.18	75	0.16	120	0.18	-	-	-	-	-	-	-	-

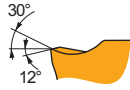

R-PR right-handed geometry with negative T-land, first choice for difficult bars parting-off, and continuous to interrupted cuts.

GL2-D200G02R06-PR:G8330	0.2	130	0.10	75	0.09	120	0.10	-	-	-	-	-	6	-
GL2-D200G02R12-PR:G8330	0.2	130	0.10	75	0.09	120	0.10	-	-	-	-	-	12	-
GL3-D300G02R06-PR:G8330	0.2	130	0.12	75	0.11	120	0.12	-	-	-	-	-	6	-
GL3-D300G02R12-PR:G8330	0.2	130	0.12	75	0.11	120	0.12	-	-	-	-	-	12	-
GL4-D400G02R06-PR:G8330	0.2	130	0.15	75	0.14	120	0.15	-	-	-	-	-	6	-
GL4-D400G02R12-PR:G8330	0.2	130	0.15	75	0.14	120	0.15	-	-	-	-	-	12	-

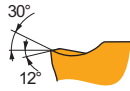

L-PR left-handed geometry with negative T-land, first choice for difficult bars parting-off, and continuous to interrupted cuts.

GL2-D200G02L06-PR:G8330	0.2	130	0.10	75	0.09	120	0.10	-	-	-	-	-	-	6
GL2-D200G02L12-PR:G8330	0.2	130	0.10	75	0.09	120	0.10	-	-	-	-	-	-	12
GL3-D300G02L06-PR:G8330	0.2	130	0.12	75	0.11	120	0.12	-	-	-	-	-	-	6
GL3-D300G02L12-PR:G8330	0.2	130	0.12	75	0.11	120	0.12	-	-	-	-	-	-	12
GL4-D400G02L06-PR:G8330	0.2	130	0.15	75	0.14	120	0.15	-	-	-	-	-	-	6
GL4-D400G02L12-PR:G8330	0.2	130	0.15	75	0.14	120	0.15	-	-	-	-	-	-	12

GL. S - PM



	CW (mm)	CWTOLL (mm)	CWTOLU (mm)	INSL (mm)
300	3.00	-0.05	0.05	24.5
400	4.00	-0.05	0.05	24.3

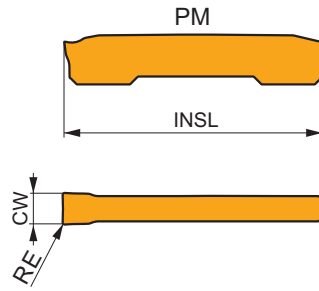

Suitability and starting values for cutting speed (vc) and feed (f). Refer to our Machining Calculator app for further calculations.

Product	RE (mm)	P		M		K		N		S		H		PSIRR (°)	PSIRL (°)
		vc (m/min)	f (mm/rev)	vc (m/min)	f (mm/rev)	vc (m/min)	f (mm/rev)	vc (m/min)	f (mm/rev)	vc (m/min)	f (mm/rev)	vc (m/min)	f (mm/rev)		

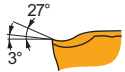

PM geometry with highly positive rake on single sided insert, first choice for deep parting-off, and continuous to slightly interrupted cuts.

GL3-S300M02-PM:G8330	0.2	130	0.10	75	0.09	120	0.10	390	0.12	30	0.07	-	-	-	-
GL4-S400M02-PM:G8330	0.2	130	0.12	75	0.11	120	0.12	390	0.14	30	0.10	-	-	-	-

GL. S - PR



	CW (mm)	CWTOLL (mm)	CWTOLU (mm)	INSL (mm)
300	3.00	-0.05	0.05	24.5
400	4.00	-0.05	0.05	24.3

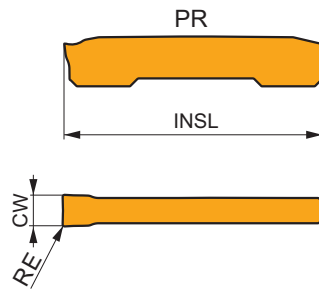

Suitability and starting values for cutting speed (vc) and feed (f). Refer to our Machining Calculator app for further calculations.

Product	RE (mm)	P		M		K		N		S		H		PSIRR (°)	PSIRL (°)
		vc (m/min)	f (mm/rev)	vc (m/min)	f (mm/rev)	vc (m/min)	f (mm/rev)	vc (m/min)	f (mm/rev)	vc (m/min)	f (mm/rev)	vc (m/min)	f (mm/rev)		

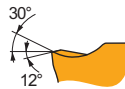

PR geometry with negative T-land on single sided insert, first choice for difficult deep grooving and parting-off, and continuous to interrupted cuts.

GL3-S300M02-PR:G8330	0.2	130	0.12	75	0.11	120	0.12	-	-	-	-	-	-	-	-
GL4-S400M02-PR:G8330	0.2	130	0.15	75	0.14	120	0.15	-	-	-	-	-	-	-	-

GL. D - GM



	CW (mm)	CWTOLL (mm)	CWTOLU (mm)	INSL (mm)
200	2.00	-0.05	0.05	25.0
300	3.00	-0.05	0.05	25.0
400	4.00	-0.05	0.05	25.0
500	5.00	-0.05	0.05	25.0
600	6.00	-0.05	0.05	25.0
800	8.00	-0.05	0.05	25.0

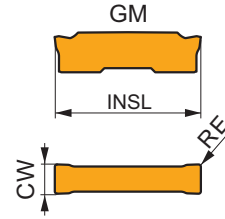

Suitability and starting values for cutting speed (vc), feed (f) and depth of cut (ap). Refer to our Machining Calculator app for further calculations.

Product	RE (mm)	P			M			K			N			S			H		
		vc (m/min)	f (mm/rev)	ap (mm)	vc (m/min)	f (mm/rev)	ap (mm)	vc (m/min)	f (mm/rev)	ap (mm)	vc (m/min)	f (mm/rev)	ap (mm)	vc (m/min)	f (mm/rev)	ap (mm)	vc (m/min)	f (mm/rev)	ap (mm)



GM versatile geometry for grooving and longitudinal turning, and continuous to interrupted cuts.

GL2-D200M02-GM:G8330	0.2	190	0.10	0.8	110	0.09	0.8	180	0.10	0.8	-	-	-	45	0.08	0.6	-	-	-
GL2-D200M02-GM:T7325	0.2	220	0.10	0.8	170	0.09	0.8	205	0.10	0.8	-	-	-	70	0.08	0.6	-	-	-
GL3-D300M02-GM:G8330	0.2	150	0.20	1.0	90	0.18	1.0	140	0.20	1.0	-	-	-	35	0.14	0.8	-	-	-
GL3-D300M02-GM:T7325	0.2	175	0.20	1.0	135	0.18	1.0	165	0.20	1.0	-	-	-	55	0.14	0.8	-	-	-
GL3-D300M04-GM:G8330	0.4	160	0.20	1.0	95	0.18	1.0	150	0.20	1.0	-	-	-	40	0.14	0.8	-	-	-
GL3-D300M04-GM:T7325	0.4	185	0.20	1.0	140	0.18	1.0	175	0.20	1.0	-	-	-	60	0.14	0.8	-	-	-
GL4-D400M04-GM:G8330	0.4	150	0.25	1.2	90	0.23	1.2	140	0.25	1.2	-	-	-	35	0.18	1.0	-	-	-
GL4-D400M04-GM:T7325	0.4	170	0.25	1.2	130	0.23	1.2	160	0.25	1.2	-	-	-	55	0.18	1.0	-	-	-
GL4-D400M08-GM:G8330	0.8	180	0.25	1.2	105	0.23	1.2	170	0.25	1.2	-	-	-	45	0.18	1.0	-	-	-
GL4-D400M08-GM:T7325	0.8	200	0.25	1.2	155	0.23	1.2	190	0.25	1.2	-	-	-	65	0.18	1.0	-	-	-
GL5-D500M08-GM:G8330	0.8	170	0.30	1.2	100	0.27	1.2	160	0.30	1.2	-	-	-	40	0.21	1.0	-	-	-
GL5-D500M08-GM:T7325	0.8	190	0.30	1.2	145	0.27	1.2	180	0.30	1.2	-	-	-	60	0.21	1.0	-	-	-
GL6-D600M08-GM:G8330	0.8	170	0.30	1.2	100	0.27	1.2	160	0.30	1.2	-	-	-	40	0.21	1.0	-	-	-
GL6-D600M08-GM:T7325	0.8	190	0.30	1.2	145	0.27	1.2	180	0.30	1.2	-	-	-	60	0.21	1.0	-	-	-
GL6-D800M08-GM:G8330 ¹⁾	0.8	170	0.30	1.2	100	0.27	1.2	160	0.30	1.2	-	-	-	40	0.21	1.2	-	-	-

¹⁾ Usable only in holders with CDX ≥ 24.

GL. D - MM



	CW (mm)	CWTOLL (mm)	CWTOLU (mm)	INSL (mm)
200	2.00	-0.05	0.05	25.0
300	3.00	-0.05	0.05	25.0
400	4.00	-0.05	0.05	25.0
500	5.00	-0.05	0.05	26.0
600	6.00	-0.05	0.05	26.0

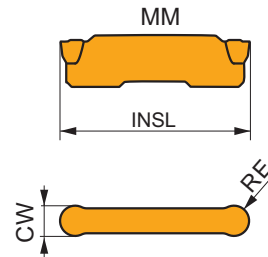

Suitability and starting values for cutting speed (vc), feed (f) and depth of cut (ap). Refer to our Machining Calculator app for further calculations.

Product	RE (mm)	P			M			K			N			S			H		
		vc (m/min)	f (mm/rev)	ap (mm)	vc (m/min)	f (mm/rev)	ap (mm)	vc (m/min)	f (mm/rev)	ap (mm)	vc (m/min)	f (mm/rev)	ap (mm)	vc (m/min)	f (mm/rev)	ap (mm)	vc (m/min)	f (mm/rev)	ap (mm)



MM geometry, with full radius shape for copy profiling and longitudinal turning, and continuous to interrupted cuts.

GL2-D200MMO-MM:G8330	1.0	250	0.10	1.0	150	0.09	1.0	235	0.10	1.0	-	-	-	60	0.08	0.8	-	-	-
GL2-D200MMO-MM:T7325	1.0	285	0.10	1.0	220	0.09	1.0	270	0.10	1.0	-	-	-	90	0.08	0.8	-	-	-
GL3-D300MMO-MM:G8330	1.5	210	0.20	1.2	125	0.18	1.2	195	0.20	1.2	-	-	-	50	0.14	1.0	-	-	-
GL3-D300MMO-MM:T7325	1.5	240	0.20	1.2	185	0.18	1.2	225	0.20	1.2	-	-	-	75	0.14	1.0	-	-	-
GL4-D400MMO-MM:G8330	2.0	220	0.20	1.2	130	0.18	1.2	205	0.20	1.2	-	-	-	55	0.14	1.0	-	-	-
GL4-D400MMO-MM:T7325	2.0	250	0.20	1.2	195	0.18	1.2	235	0.20	1.2	-	-	-	80	0.14	1.0	-	-	-
GL5-D500MMO-MM:G8330	2.5	205	0.25	1.2	120	0.23	1.2	190	0.25	1.2	-	-	-	50	0.18	1.0	-	-	-
GL5-D500MMO-MM:T7325	2.5	235	0.25	1.2	180	0.23	1.2	220	0.25	1.2	-	-	-	75	0.18	1.0	-	-	-
GL6-D600MMO-MM:G8330	3.0	195	0.30	1.2	115	0.27	1.2	185	0.30	1.2	-	-	-	45	0.21	1.0	-	-	-
GL6-D600MMO-MM:T7325	3.0	220	0.30	1.2	170	0.27	1.2	205	0.30	1.2	-	-	-	70	0.21	1.0	-	-	-

LCM. – EXTERNAL TOOLS NAVIGATOR

INSERT SEAT	0316	0416	0516	0616	0830
GFI(RL) EXT 16×16 32×25					
GFM(RL) EXT 20×20 32×25					
Cutting width (mm)	3	4	5	6	8
Deep parting-off (single sided insert) 	 LCMR CM	 LCMR CM			
Parting-off (tube / full bar) 	 CM F	 CM F	 CM F	 CM F	 F
Grooving (deep / shallow) 	 F M	 F M	 F M	 F M	 F
Turning (longitudinal) 	 F M	 F M	 F M	 F M	 F
Profiling (multiaxial) 	 MP	 MP	 MP	 MP	 MP

GFI(RL) EXT



PRAMET



External V-Groove Top Clamp Grooving and Turning Tool for LCM. Inserts



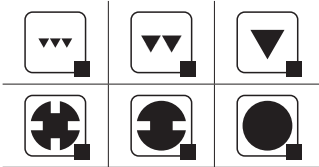
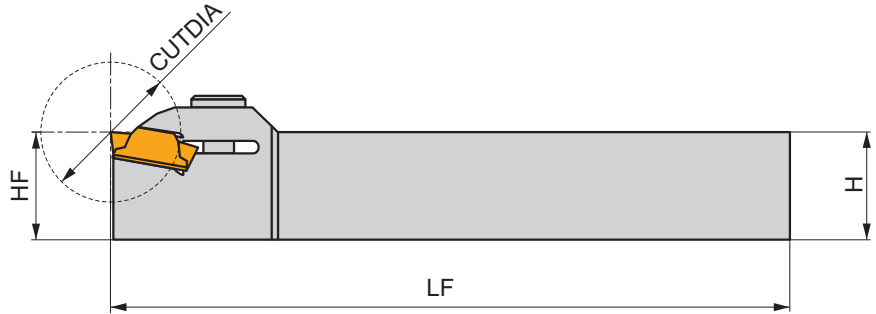
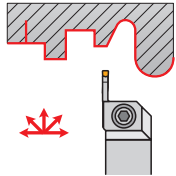



External Right/Left hand tool holder for grooving with LCM. inserts. Suited for parting-off, grooving, profiling and longitudinal turning applications. Body treated for longer tool life.



Product	Ξ	H	B	LF	CW	CUTDIA	kg			
	(mm)	(mm)	(mm)	(mm)	(mm)	(mm)				
R	GFIR 1616 H 03	16	16	16	100	3.00	18	0.22	G1136	GL03
	GFIR 2020 K 03	20	20	20	125	3.00	18	0.40	G1136	GL04
	GFIR 2525 M 03	25	25	25	150	3.00	18	0.73	G1136	GL05
	GFIR 1616 H 04	16	16	16	100	4.00	24	0.21	G1137	GL03
	GFIR 2020 K 04	20	20	20	125	4.00	24	0.39	G1137	GL04
	GFIR 2525 M 04	25	25	25	150	4.00	24	0.71	G1137	GL05
	GFIR 2020 K 05	20	20	20	125	5.00	28	0.38	G1138	GL04
	GFIR 2525 M 05	25	25	25	150	5.00	28	0.70	G1138	GL05
	GFIR 2020 K 06	20	20	20	125	6.00	28	0.38	G1139	GL04
	GFIR 2525 M 06	25	25	25	150	6.00	28	0.70	G1139	GL05
	GFIR 2525 M 08	25	25	25	150	8.00	48	0.74	G1193	GL09
	GFIR 3225 P 08	32	32	25	170	8.00	48	1.01	G1193	GL09
L	GFIL 1616 H 03	16	16	16	100	3.00	18	0.22	G1136	GL03
	GFIL 2020 K 03	20	20	20	125	3.00	18	0.39	G1136	GL04
	GFIL 2525 M 03	25	25	25	150	3.00	18	0.73	G1136	GL05
	GFIL 1616 H 04	16	16	16	100	4.00	24	0.20	G1137	GL03
	GFIL 2020 K 04	20	20	20	125	4.00	24	0.38	G1137	GL04
	GFIL 2525 M 04	25	25	25	150	4.00	24	0.71	G1137	GL05
	GFIL 2020 K 05	20	20	20	125	5.00	28	0.38	G1138	GL04
	GFIL 2525 M 05	25	25	25	150	5.00	28	0.71	G1138	GL05
	GFIL 2020 K 06	20	20	20	125	6.00	28	0.40	G1139	GL04
	GFIL 2525 M 06	25	25	25	150	6.00	28	0.70	G1139	GL05
	GFIL 2525 M 08	25	25	25	150	8.00	48	0.74	G1193	GL09
	GFIL 3225 P 08	32	32	25	170	8.00	48	1.02	G1193	GL09



GI136	LCM. 0316..
GI137	LCM. 0416..
GI138	LCM. 0516..
GI139	LCM. 0616..
GI193	LCM. 0830..

		 Nm			
GL03	HS 0616C	6.0	M 6	16	HXX 5
GL04	HS 0620C	6.0	M 6	20	HXX 5
GL05	HS 0625C	6.0	M 6	25	HXX 5
GL09	HSI 1020	8.0	M 10	20	HXX 8

GFM(RL) EXT



PRAMET



External V-Groove Top Clamp Grooving and Turning Tool for LCM. Inserts

External Right/Left hand tool holder for grooving with LCM. inserts. Suited for parting-off, grooving, profiling and longitudinal turning applications. Body treated for longer tool life.

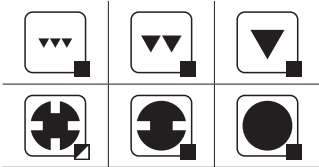
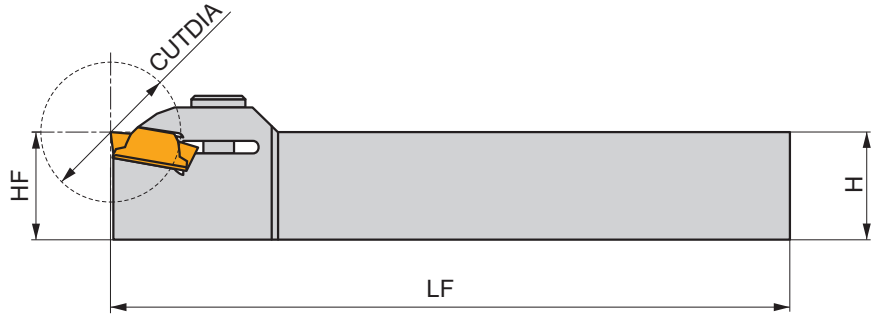
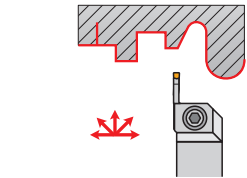

Product	≡	H	B	LF	CW	CUTDIA	kg			
	(mm)	(mm)	(mm)	(mm)	(mm)	(mm)				
R	GFMR 2020 K 0316	20	20	20	125	3.00	30	0.37	GI136	GL04
	GFMR 2525 M 0316	25	25	25	150	3.00	30	0.68	GI136	GL04
	GFMR 2020 K 0416	20	20	20	125	4.00	40	0.37	GI137	GL04
	GFMR 2525 M 0416	25	25	25	150	4.00	40	0.67	GI137	GL04
	GFMR 2525 M 0516	25	25	25	150	5.00	50	0.65	GI138	GL04
	GFMR 3225 P 0516	32	32	25	170	5.00	50	0.96	GI138	GL04
	GFMR 2525 M 0616	25	25	25	150	6.00	60	0.66	GI139	GL04
	GFMR 3225 P 0616	32	32	25	170	6.00	60	0.95	GI139	GL04
	GFMR 3225 P 0830	32	32	25	170	8.00	80	0.97	GI193	GL10
L	GFML 2020 K 0316	20	20	20	125	3.00	30	0.36	GI136	GL04
	GFML 2525 M 0316	25	25	25	150	3.00	30	0.69	GI136	GL04
	GFML 2020 K 0416	20	20	20	125	4.00	40	0.37	GI137	GL04
	GFML 2525 M 0416	25	25	25	150	4.00	40	0.67	GI137	GL04
	GFML 2525 M 0516	25	25	25	150	5.00	50	0.66	GI138	GL04
	GFML 3225 P 0516	32	32	25	170	5.00	50	0.96	GI138	GL04
	GFML 2525 M 0616	25	25	25	150	6.00	60	0.64	GI139	GL04
	GFML 3225 P 0616	32	32	25	170	6.00	60	0.95	GI139	GL04
	GFML 3225 P 0830	32	32	25	170	8.00	80	0.97	GI193	GL10

GI136		LCM. 0316..
GI137		LCM. 0416..
GI138		LCM. 0516..
GI139		LCM. 0616..
GI193		LCM. 0830..

GL04	HS 0620C	6.0	M 6	20	HXK 5
GL10	HSI 1020	8.0	M 10	20	HXK 8

LCMF 16 - CM



	CW (mm)	CWTOLL (mm)	CWTOLU (mm)	INSL (mm)
0316	3.00	-0.05	0.05	16.4
0416	4.00	-0.05	0.05	16.4
0516	5.00	-0.05	0.05	16.4
0616	6.00	-0.05	0.05	16.4

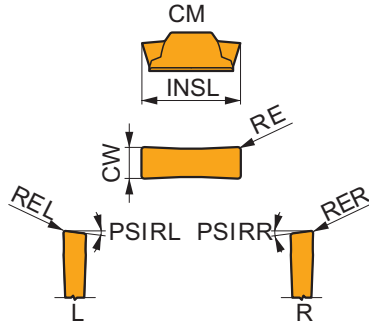

Suitability and starting values for cutting speed (vc) and feed (f). Refer to our Machining Calculator app for further calculations.

Product	RE (mm)	P		M		K		N		S		H		PSIRR (°)	PSIRL (°)
		vc (m/min)	f (mm/rev)	vc (m/min)	f (mm/rev)	vc (m/min)	f (mm/rev)	vc (m/min)	f (mm/rev)	vc (m/min)	f (mm/rev)	vc (m/min)	f (mm/rev)		

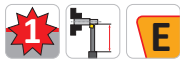

CM geometry, first choice for parting-off and grooving, and continuous to slightly interrupted cuts.

LCMF 031602-CM:T8330	0.2	130	0.11	75	0.10	120	0.11	-	-	-	-	-	-	-	-
LCMF 031604-CM:T8330	0.4	130	0.11	75	0.10	120	0.11	-	-	-	-	-	-	-	-
LCMF 041602-CM:T8330	0.2	130	0.11	75	0.10	120	0.11	-	-	-	-	-	-	-	-
LCMF 041604-CM:T8330	0.4	130	0.11	75	0.10	120	0.11	-	-	-	-	-	-	-	-
LCMF 051604-CM:T8330	0.4	130	0.11	75	0.11	120	0.11	-	-	-	-	-	-	-	-
LCMF 061604-CM:T8330	0.4	130	0.11	75	0.11	120	0.11	-	-	-	-	-	-	-	-

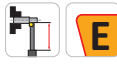
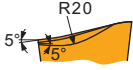

R-CM geometry, right-handed design, first choice for parting-off and continuous to slightly interrupted cuts.

LCMF 031602R15-CM:T8330¹⁾	0.2	130	0.11	75	0.10	120	0.11	-	-	-	-	-	15	-
LCMF 031602R6-CM:T8330	0.2	130	0.11	75	0.10	120	0.11	-	-	-	-	-	6	-
LCMF 041602R15-CM:T8330¹⁾	0.2	130	0.11	75	0.10	120	0.11	-	-	-	-	-	15	-
LCMF 041602R6-CM:T8330	0.2	130	0.11	75	0.10	120	0.11	-	-	-	-	-	6	-

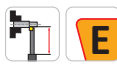
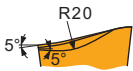

L-CM geometry, left-handed design, first choice for parting-off and continuous to slightly interrupted cuts.

LCMF 031602L15-CM:T8330¹⁾	0.2	130	0.11	75	0.10	120	0.11	-	-	-	-	-	-	15
LCMF 031602L6-CM:T8330	0.2	130	0.11	75	0.10	120	0.11	-	-	-	-	-	-	6
LCMF 041602L15-CM:T8330¹⁾	0.2	130	0.11	75	0.10	120	0.11	-	-	-	-	-	-	15
LCMF 041602L6-CM:T8330	0.2	130	0.11	75	0.10	120	0.11	-	-	-	-	-	-	6

¹⁾ Toolholders have to be modified.

LCMF 16, LCMF 30 - F



	CW	CWTOLL	CWTOLU	INSL
	(mm)	(mm)	(mm)	(mm)
0316	3.00	-0.05	0.05	16.4
0416	4.00	-0.05	0.05	16.4
0516	5.00	-0.05	0.05	16.4
0616	6.00	-0.05	0.05	16.4
0830	8.00	-0.05	0.05	30.0

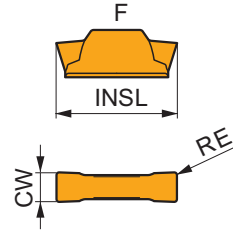

Suitability and starting values for cutting speed (vc), feed (f) and depth of cut (ap). Refer to our Machining Calculator app for further calculations.

Product	RE (mm)	P			M			K			N			S			H		
		vc (m/min)	f (mm/rev)	ap (mm)	vc (m/min)	f (mm/rev)	ap (mm)	vc (m/min)	f (mm/rev)	ap (mm)	vc (m/min)	f (mm/rev)	ap (mm)	vc (m/min)	f (mm/rev)	ap (mm)	vc (m/min)	f (mm/rev)	ap (mm)

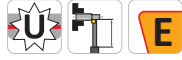
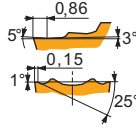
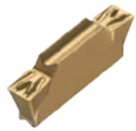

F geometry for parting-off, grooving and axial turning, fine and finish machining, and continuous to slightly interrupted cuts.

LCMF 031602-F:T8330	0.2	195	0.10	0.3	115	0.09	0.3	185	0.10	0.3	-	-	-	-	-	-	-	-
LCMF 031604-F:T8330	0.4	200	0.10	0.5	120	0.09	0.5	190	0.10	0.5	-	-	-	-	-	-	-	-
LCMF 041604-F:T8330	0.4	185	0.13	0.5	110	0.12	0.5	175	0.13	0.5	-	-	-	-	-	-	-	-
LCMF 041604-F:T9325	0.4	275	0.13	0.5	165	0.12	0.5	260	0.13	0.5	-	-	-	-	-	-	-	-
LCMF 041608-F:T8330	0.8	205	0.13	1.0	120	0.12	1.0	190	0.13	1.0	-	-	-	-	-	-	-	-
LCMF 041608-F:T9325	0.8	305	0.13	1.0	180	0.12	1.0	285	0.13	1.0	-	-	-	-	-	-	-	-
LCMF 051608-F:T8330	0.8	195	0.15	1.0	115	0.14	1.0	185	0.15	1.0	-	-	-	-	-	-	-	-
LCMF 051608-F:T9325	0.8	285	0.15	1.0	170	0.14	1.0	270	0.15	1.0	-	-	-	-	-	-	-	-
LCMF 061608-F:T8330	0.8	190	0.17	1.0	110	0.15	1.0	180	0.17	1.0	-	-	-	-	-	-	-	-
LCMF 061608-F:T9325	0.8	270	0.17	1.0	160	0.15	1.0	255	0.17	1.0	-	-	-	-	-	-	-	-

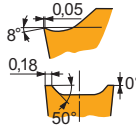

F geometry for parting-off, grooving and axial turning, fine and finish machining, and continuous to slightly interrupted cuts.

LCMF 083008-F:T8330	0.8	175	0.25	1.0	105	0.23	1.0	165	0.25	1.0	-	-	-	-	-	-	-	-
LCMF 083012-F:T8330	1.2	170	0.25	1.5	100	0.23	1.5	160	0.25	1.5	-	-	-	-	-	-	-	-

LCMF 16 - M



	CW	CWTOLL	CWTOLU	INSL
	(mm)	(mm)	(mm)	(mm)
0316	3.00	-0.05	0.05	16.4
0416	4.00	-0.05	0.05	16.4
0516	5.00	-0.05	0.05	16.4
0616	6.00	-0.05	0.05	16.4

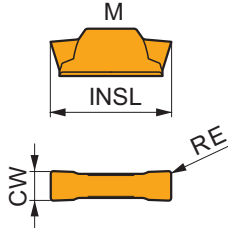

Suitability and starting values for cutting speed (vc), feed (f) and depth of cut (ap). Refer to our Machining Calculator app for further calculations.

Product	RE (mm)	P			M			K			N			S			H		
		vc (m/min)	f (mm/rev)	ap (mm)	vc (m/min)	f (mm/rev)	ap (mm)	vc (m/min)	f (mm/rev)	ap (mm)	vc (m/min)	f (mm/rev)	ap (mm)	vc (m/min)	f (mm/rev)	ap (mm)	vc (m/min)	f (mm/rev)	ap (mm)

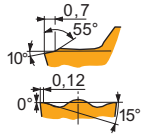

M geometry for grooving and longitudinal turning, and continuous to interrupted cuts.

LCMF 031602-M:T8330	0.2	160	0.13	1.0	95	0.12	1.0	150	0.13	1.0	-	-	-	-	-	-	30	0.10	0.7
LCMF 031604-M:T8330	0.4	170	0.13	1.0	100	0.12	1.0	160	0.13	1.0	-	-	-	-	-	-	30	0.10	0.7
LCMF 041604-M:T8330	0.4	155	0.18	1.0	90	0.16	1.0	145	0.18	1.0	-	-	-	-	-	-	30	0.12	0.8
LCMF 041604-M:T9325	0.4	225	0.18	1.0	135	0.16	1.0	210	0.18	1.0	-	-	-	-	-	-	-	-	-
LCMF 041608-M:T8330	0.8	185	0.18	1.0	110	0.16	1.0	175	0.18	1.0	-	-	-	-	-	-	35	0.12	0.8
LCMF 041608-M:T9325	0.8	265	0.18	1.0	155	0.16	1.0	250	0.18	1.0	-	-	-	-	-	-	-	-	-
LCMF 051608-M:T8330	0.8	180	0.20	1.0	105	0.18	1.0	170	0.20	1.0	-	-	-	-	-	-	35	0.13	1.0
LCMF 051608-M:T9325	0.8	255	0.20	1.0	150	0.18	1.0	240	0.20	1.0	-	-	-	-	-	-	-	-	-
LCMF 061608-M:T8330	0.8	175	0.25	1.0	105	0.23	1.0	165	0.25	1.0	-	-	-	-	-	-	35	0.13	1.0
LCMF 061608-M:T9325	0.8	230	0.25	1.0	135	0.23	1.0	215	0.25	1.0	-	-	-	-	-	-	-	-	-

LCMF 16, LCMF 30 - MP



	CW	CWTOLL	CWTOLU	INSL
	(mm)	(mm)	(mm)	(mm)
0316	3.00	-0.05	0.05	17.5
0416	4.00	-0.05	0.05	17.6
0516	5.00	-0.05	0.05	18.3
0616	6.00	-0.05	0.05	18.5
0830	8.00	-0.05	0.05	30.9

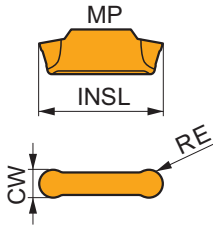

Suitability and starting values for cutting speed (vc), feed (f) and depth of cut (ap). Refer to our Machining Calculator app for further calculations.

Product	RE (mm)	P			M			K			N			S			H		
		vc (m/min)	f (mm/rev)	ap (mm)	vc (m/min)	f (mm/rev)	ap (mm)	vc (m/min)	f (mm/rev)	ap (mm)	vc (m/min)	f (mm/rev)	ap (mm)	vc (m/min)	f (mm/rev)	ap (mm)	vc (m/min)	f (mm/rev)	ap (mm)

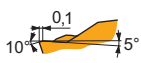

MP geometry for longitudinal turning and copy profiling, and continuous to interrupted cuts.

LCMF 0316MO-MP:T8330	1.5	190	0.30	0.8	110	0.27	0.8	180	0.30	0.8	-	-	-	-	-	-	-	-	-
LCMF 0416MO-MP:T8330	2.0	175	0.40	1.0	105	0.36	1.0	165	0.40	1.0	-	-	-	-	-	-	-	-	-
LCMF 0416MO-MP:T9325	2.0	220	0.40	1.0	130	0.36	1.0	205	0.40	1.0	-	-	-	-	-	-	-	-	-
LCMF 0516MO-MP:T8330	2.5	170	0.45	1.0	100	0.41	1.0	160	0.45	1.0	-	-	-	-	-	-	-	-	-
LCMF 0516MO-MP:T9325	2.5	205	0.45	1.0	120	0.41	1.0	190	0.45	1.0	-	-	-	-	-	-	-	-	-
LCMF 0616MO-MP:T8330	3.0	165	0.50	1.0	95	0.45	1.0	155	0.50	1.0	-	-	-	-	-	-	-	-	-
LCMF 0616MO-MP:T9325	3.0	200	0.50	1.0	120	0.45	1.0	190	0.50	1.0	-	-	-	-	-	-	-	-	-
LCMF 0830MO-MP:T8330	4.0	150	0.60	1.2	90	0.54	1.2	140	0.60	1.2	-	-	-	-	-	-	-	-	-

LCMR 16 - CM



	CW (mm)	CWTOLL (mm)	CWTOLU (mm)	INSL (mm)
0316	3.00	-0.05	0.05	16.4
0416	4.00	-0.05	0.05	16.4

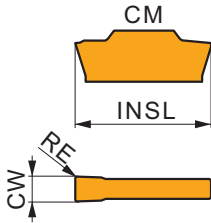

Suitability and starting values for cutting speed (vc) and feed (f). Refer to our Machining Calculator app for further calculations.

Product	RE (mm)	P		M		K		N		S		H		PSIRR (°)	PSIRL (°)
		vc (m/min)	f (mm/rev)	vc (m/min)	f (mm/rev)	vc (m/min)	f (mm/rev)	vc (m/min)	f (mm/rev)	vc (m/min)	f (mm/rev)	vc (m/min)	f (mm/rev)		
LCMR 031602-CM:T8330	0.2	130	0.11	75	0.10	120	0.11	-	-	-	-	-	-	-	-
LCMR 041604-CM:T8330	0.4	130	0.11	75	0.10	120	0.11	-	-	-	-	-	-	-	-

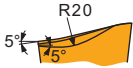

CM geometry, first choice for parting-off and grooving, and continuous to slightly interrupted cuts.

LCMR 031602-CM:T8330	0.2	130	0.11	75	0.10	120	0.11	-	-	-	-	-	-	-	-
LCMR 041604-CM:T8330	0.4	130	0.11	75	0.10	120	0.11	-	-	-	-	-	-	-	-

LCMR 16, LCMR 30 - F



	CW (mm)	CWTOLL (mm)	CWTOLU (mm)	INSL (mm)
0316	3.00	-0.05	0.05	16.4
0416	4.00	-0.05	0.05	16.4
0516	5.00	-0.05	0.05	16.4
0616	6.00	-0.05	0.05	16.4

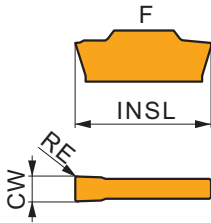

Suitability and starting values for cutting speed (vc), feed (f) and depth of cut (ap). Refer to our Machining Calculator app for further calculations.

Product	RE (mm)	P			M			K			N			S			H		
		vc (m/min)	f (mm/rev)	ap (mm)	vc (m/min)	f (mm/rev)	ap (mm)	vc (m/min)	f (mm/rev)	ap (mm)	vc (m/min)	f (mm/rev)	ap (mm)	vc (m/min)	f (mm/rev)	ap (mm)	vc (m/min)	f (mm/rev)	ap (mm)
LCMR 031604-F:T8330	0.4	200	0.10	0.5	120	0.09	0.5	190	0.10	0.5	-	-	-	-	-	-	-	-	-
LCMR 041604-F:T8330	0.4	185	0.13	0.5	110	0.12	0.5	175	0.13	0.5	-	-	-	-	-	-	-	-	-
LCMR 051604-F:T8330	0.4	180	0.15	0.5	105	0.14	0.5	170	0.15	0.5	-	-	-	-	-	-	-	-	-
LCMR 061608-F:T8330	0.8	190	0.17	1.0	110	0.15	1.0	180	0.17	1.0	-	-	-	-	-	-	-	-	-

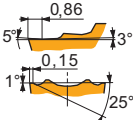

F geometry for parting-off, grooving and longitudinal turning, fine and finish machining, and continuous to slightly interrupted cuts.

LCMR 031604-F:T8330	0.4	200	0.10	0.5	120	0.09	0.5	190	0.10	0.5	-	-	-	-	-	-	-	-	-
LCMR 041604-F:T8330	0.4	185	0.13	0.5	110	0.12	0.5	175	0.13	0.5	-	-	-	-	-	-	-	-	-
LCMR 051604-F:T8330	0.4	180	0.15	0.5	105	0.14	0.5	170	0.15	0.5	-	-	-	-	-	-	-	-	-
LCMR 061608-F:T8330	0.8	190	0.17	1.0	110	0.15	1.0	180	0.17	1.0	-	-	-	-	-	-	-	-	-

LCMR 16 - M



	CW	CWTOLL	CWTOLU	INSL
	(mm)	(mm)	(mm)	(mm)
0316	3.00	-0.05	0.05	16.4
0416	4.00	-0.05	0.05	16.4
0516	5.00	-0.05	0.05	16.4
0616	6.00	-0.05	0.05	16.4

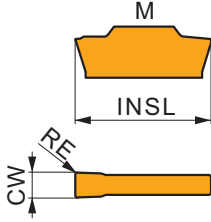

Suitability and starting values for cutting speed (vc), feed (f) and depth of cut (ap). Refer to our Machining Calculator app for further calculations.

Product	RE (mm)	P			M			K			N			S			H		
		vc (m/min)	f (mm/rev)	ap (mm)	vc (m/min)	f (mm/rev)	ap (mm)	vc (m/min)	f (mm/rev)	ap (mm)	vc (m/min)	f (mm/rev)	ap (mm)	vc (m/min)	f (mm/rev)	ap (mm)	vc (m/min)	f (mm/rev)	ap (mm)

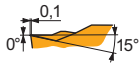
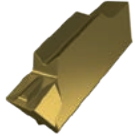

M geometry for grooving and longitudinal turning, and continuous to interrupted cuts.

LCMR 031604-M:T8330	0.4	170	0.13	1.0	100	0.12	1.0	160	0.13	1.0	–	–	–	–	–	–	30	0.10	0.7
LCMR 041604-M:T8330	0.4	155	0.18	1.0	90	0.16	1.0	145	0.18	1.0	–	–	–	–	–	–	30	0.12	0.8
LCMR 051604-M:T8330	0.4	150	0.20	1.0	90	0.18	1.0	140	0.20	1.0	–	–	–	–	–	–	30	0.13	1.0
LCMR 061608-M:T8330	0.8	175	0.25	1.0	105	0.23	1.0	165	0.25	1.0	–	–	–	–	–	–	35	0.13	1.0

LCMR 16 - MP



	CW	CWTOLL	CWTOLU	INSL
	(mm)	(mm)	(mm)	(mm)
0316	3.00	-0.05	0.05	17.4
0416	4.00	-0.05	0.05	17.5
0516	5.00	-0.05	0.05	18.1
0616	6.00	-0.05	0.05	18.3

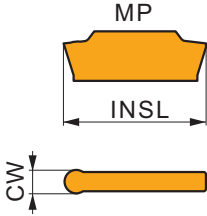

Suitability and starting values for cutting speed (vc), feed (f) and depth of cut (ap). Refer to our Machining Calculator app for further calculations.

Product	RE (mm)	P			M			K			N			S			H		
		vc (m/min)	f (mm/rev)	ap (mm)	vc (m/min)	f (mm/rev)	ap (mm)	vc (m/min)	f (mm/rev)	ap (mm)	vc (m/min)	f (mm/rev)	ap (mm)	vc (m/min)	f (mm/rev)	ap (mm)	vc (m/min)	f (mm/rev)	ap (mm)

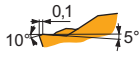

MP geometry for longitudinal turning and copy profiling, and continuous to interrupted cuts.

LCMR 0316M0-MP:T8330	1.5	190	0.30	0.8	110	0.27	0.8	180	0.30	0.8	–	–	–	–	–	–	–	–	–
LCMR 0416M0-MP:T8330	2.0	175	0.40	1.0	105	0.36	1.0	165	0.40	1.0	–	–	–	–	–	–	–	–	–
LCMR 0516M0-MP:T8330	2.5	170	0.45	1.0	100	0.41	1.0	160	0.45	1.0	–	–	–	–	–	–	–	–	–
LCMR 0616M0-MP:T8330	3.0	165	0.50	1.0	95	0.45	1.0	155	0.50	1.0	–	–	–	–	–	–	–	–	–

GL – BLADES & ACCESSORIES NAVIGATOR

INSERT SEAT	GL1	GL2	GL3	GL4	GL5	GL6	
Blades H = 26; 32 mm NEW MS Blades	CDX 16 mm NEW CDX 35-50 mm CDX 35-50 mm CDX 50 mm CDX 60 mm CDX 60 mm	CDX 24 mm CDX 24 mm CDX 24 mm CDX 24 mm CDX 24 mm	CDX 24 mm CDX 24 mm CDX 24 mm CDX 24 mm	CDX 24 mm CDX 24 mm CDX 24 mm	CDX 24 mm CDX 24 mm	CDX 24 mm	CDX 24 mm
Cutting width (mm) NEW Deep parting-off (single sided insert) 	1.5	2	3 (2.5)	4	5	6	8
Parting-off (tube / full bar) 	NEW PM	PM	CW = 2.5 / 3 PM	PM	PM	PM	PM
Grooving (deep / shallow) 		PR GM	PR GM	PR GM	PR GM	PR GM	NEW GM

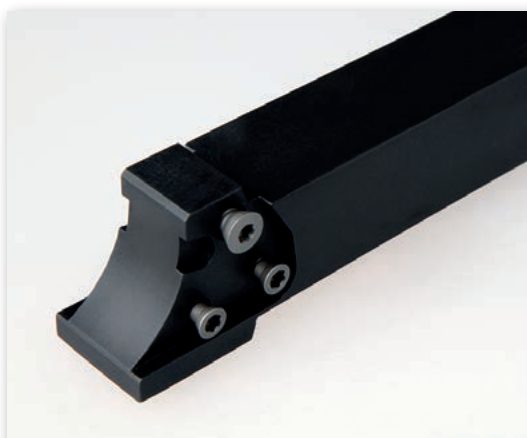

MS-EN

- Modular Tool Holder
- Shank sizes:
20 × 20, 25 × 25, 32 × 32 mm



DU, D

- Tool Holder Block
- Shank sizes:
20 × 20, 25 × 23, 25 × 32, 32 × 29, 25 × 30 mm

GLS B



PRAMET

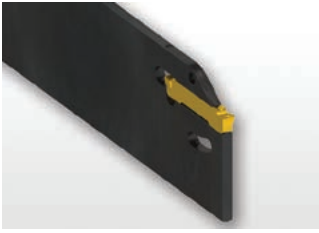

Double-Ended Parting-off and Grooving Blade for GL Inserts

Blade for GL inserts, suited for parting-off and grooving applications. Easy inserts replacement by specific key (included in package). Can be fitted into the DU, D tool holder block. Body treated for longer tool life.

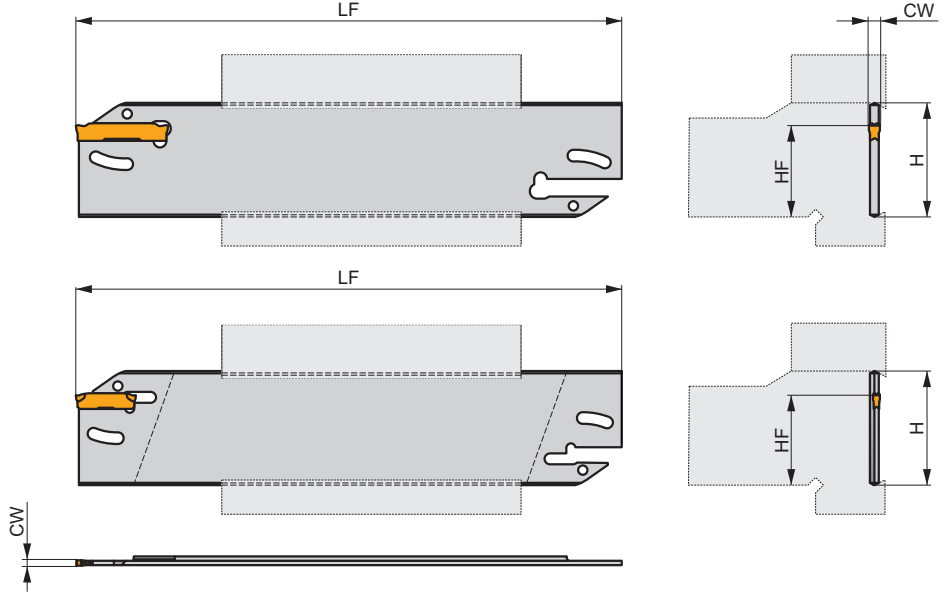
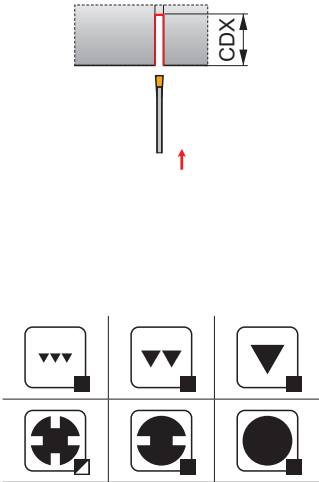

Product	HF	H	LF	CW	CDX	kg			
	(mm)	(mm)	(mm)	(mm)	(mm)				
R GL1-S26KBR-16	21.4	26	125	1.50	16	0.05	G1333	KV2	
	GL1-S32MBR-16	32	32	150	1.50	16	0.07	G1333	KV2
L GL1-S26KBL-16	21.4	26	125	1.50	16	0.05	G1333	KV2	
	GL1-S32MBL-16	32	32	150	1.50	16	0.07	G1333	KV2
N	GL2-S26KB	21.4	26	125	2.00	35	0.13	G1334	KV2
	GL2-S32MB	25	32	150	2.00	50	0.15	G1334	KV2
	GL3-S26KB	21.4	26	125	3.00	35	0.15	G1335	KV2
	GL3-S32MB	25	32	150	3.00	50	0.15	G1335	KV2
	GL4-S32MB	25	32	150	4.00	50	0.19	G1336	KV2
	GL5-S32MB	25	32	150	5.00	60	0.22	G1337	KV2
GL6-S32MB	25	32	150	6.00	60	0.25	G1338	KV2	

G1333	GL1..	-
G1334	GL2..	-
G1335	GL3..	-
G1336	GL4..	-
G1337	GL5..	-
G1338	GL6-D600..	GL6-D800..

KV2	KV 15x150

GLS BS

P
M
K
N
S
H

PRAMET

G



Grooving and Parting-off Blade for GL Inserts, for MS-EN Tool Holder

Blade for modular tool holder MS-EN, designed for GL inserts. Suited for grooving and parting-off applications. Blades treated for longer tool life.

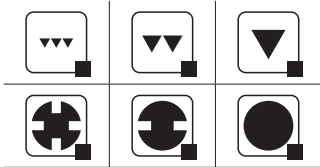
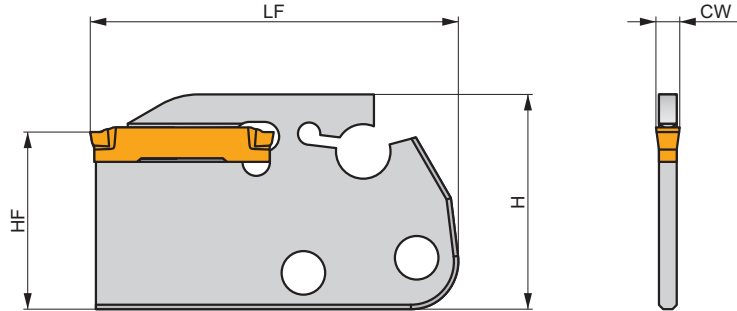
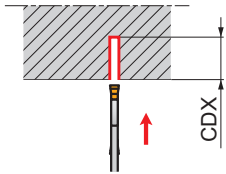

Product	Ξ (mm)	Ξ (mm)	LF (mm)	CW (mm)	CDX (mm)	kg	
GL2-S29CBS	24	29	50	2.00	24	0.01	GI334
GL3-S29CBS	24	29	50	3.00	24	0.02	GI335
GL4-S29CBS	24	29	50	4.00	24	0.02	GI336
GL5-S29CBS	24	29	50	5.00	24	0.03	GI337
GL6-S29CBS	24	29	50	6.00	24	0.04	GI338

GI334	GL2..	-
GI335	GL3..	-
GI336	GL4..	-
GI337	GL5..	-
GI338	GL6-D600..	GL6-D800..

GL. D - PM



	CW (mm)	CWTOLL (mm)	CWTOLU (mm)	INSL (mm)
150	1.50	-0.04	0.04	16.5
200	2.00	-0.05	0.05	25.0
250	2.55	-0.05	0.05	25.0
300	3.00	-0.05	0.05	25.0
400	4.00	-0.05	0.05	25.0
500	5.00	-0.05	0.05	25.0
600	6.00	-0.05	0.05	25.0

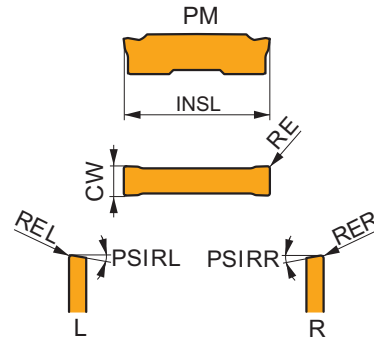

Suitability and starting values for cutting speed (vc) and feed (f). Refer to our Machining Calculator app for further calculations.

Product	RE (mm)	P		M		K		N		S		H		PSIRR (°)	PSIRL (°)
		vc (m/min)	f (mm/rev)	vc (m/min)	f (mm/rev)	vc (m/min)	f (mm/rev)	vc (m/min)	f (mm/rev)	vc (m/min)	f (mm/rev)	vc (m/min)	f (mm/rev)		

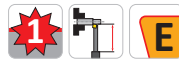
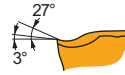

PM geometry with highly positive rake, first choice for parting-off, and continuous to slightly interrupted cuts.

GL1-D150M015-PM:G8330	●	0.1	130	0.05	75	0.05	120	0.05	390	0.06	30	0.04	-	-	-	-
GL2-D200M02-PM:G8330	●	0.2	130	0.08	75	0.07	120	0.08	390	0.10	30	0.06	-	-	-	-
GL2-D200M02-PM:T7325	●	0.2	150	0.08	115	0.07	140	0.08	-	-	45	0.06	-	-	-	-
GL3-D250G02-PM:G8330	●	0.2	130	0.10	75	0.09	120	0.10	390	0.12	30	0.07	-	-	-	-
GL3-D300M02-PM:G8330	●	0.2	130	0.10	75	0.09	120	0.10	390	0.12	30	0.07	-	-	-	-
GL3-D300M02-PM:T7325	●	0.2	150	0.10	115	0.09	140	0.10	-	-	45	0.07	-	-	-	-
GL4-D400M02-PM:G8330	●	0.2	130	0.12	75	0.11	120	0.12	390	0.14	30	0.10	-	-	-	-
GL4-D400M02-PM:T7325	●	0.2	150	0.12	115	0.11	140	0.12	-	-	45	0.10	-	-	-	-
GL5-D500M03-PM:G8330	●	0.3	130	0.15	75	0.14	120	0.15	390	0.18	30	0.12	-	-	-	-
GL6-D600M03-PM:G8330	●	0.3	130	0.15	75	0.14	120	0.15	390	0.18	30	0.12	-	-	-	-

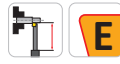
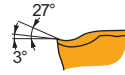

R-PM right-handed geometry with highly positive rake, first choice for tubes parting-off, and continuous cuts.

GL1-D150G015R06-PM:G8330	●	0.1	130	0.05	75	0.05	120	0.05	390	0.06	30	0.04	-	-	6	-
GL1-D150G015R12-PM:G8330	●	0.1	130	0.05	75	0.05	120	0.05	390	0.06	30	0.04	-	-	12	-
GL2-D200G02R06-PM:G8330	●	0.2	130	0.08	75	0.07	120	0.08	390	0.10	30	0.06	-	-	6	-
GL2-D200G02R06-PM:T7325	●	0.2	150	0.08	115	0.07	140	0.08	-	-	45	0.06	-	-	6	-
GL2-D200G02R12-PM:G8330	●	0.2	130	0.08	75	0.07	120	0.08	390	0.10	30	0.06	-	-	12	-
GL3-D300G02R06-PM:G8330	●	0.2	130	0.10	75	0.09	120	0.10	390	0.12	30	0.07	-	-	6	-
GL3-D300G02R06-PM:T7325	●	0.2	150	0.10	115	0.09	140	0.10	-	-	45	0.07	-	-	6	-
GL3-D300G02R12-PM:G8330	●	0.2	130	0.10	75	0.09	120	0.10	390	0.12	30	0.07	-	-	12	-
GL4-D400G02R06-PM:G8330	●	0.2	130	0.12	75	0.11	120	0.12	390	0.14	30	0.10	-	-	6	-
GL4-D400G02R06-PM:T7325	●	0.2	150	0.12	115	0.11	140	0.12	-	-	45	0.10	-	-	6	-
GL4-D400G02R12-PM:G8330	●	0.2	130	0.12	75	0.11	120	0.12	390	0.14	30	0.10	-	-	12	-

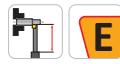
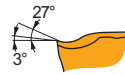

L-PM left-handed geometry with highly positive rake, first choice for tubes parting-off, and continuous cuts.

GL1-D150G015L06-PM:G8330	●	0.1	130	0.05	75	0.05	120	0.05	390	0.06	30	0.04	-	-	-	6
GL1-D150G015L12-PM:G8330	●	0.1	130	0.05	75	0.05	120	0.05	390	0.06	30	0.04	-	-	-	12
GL2-D200G02L06-PM:G8330	●	0.2	130	0.08	75	0.07	120	0.08	390	0.10	30	0.06	-	-	-	6
GL2-D200G02L06-PM:T7325	●	0.2	150	0.08	115	0.07	140	0.08	-	-	45	0.06	-	-	-	6
GL2-D200G02L12-PM:G8330	●	0.2	130	0.08	75	0.07	120	0.08	390	0.10	30	0.06	-	-	-	12
GL3-D300G02L06-PM:G8330	●	0.2	130	0.10	75	0.09	120	0.10	390	0.12	30	0.07	-	-	-	6
GL3-D300G02L06-PM:T7325	●	0.2	150	0.10	115	0.09	140	0.10	-	-	45	0.07	-	-	-	6
GL3-D300G02L12-PM:G8330	●	0.2	130	0.10	75	0.09	120	0.10	390	0.12	30	0.07	-	-	-	12
GL4-D400G02L06-PM:G8330	●	0.2	130	0.12	75	0.11	120	0.12	390	0.14	30	0.10	-	-	-	6
GL4-D400G02L06-PM:T7325	●	0.2	150	0.12	115	0.11	140	0.12	-	-	45	0.10	-	-	-	6
GL4-D400G02L12-PM:G8330	●	0.2	130	0.12	75	0.11	120	0.12	390	0.14	30	0.10	-	-	-	12

GL. D - PR



	CW (mm)	CWTOLL (mm)	CWTOLU (mm)	INSL (mm)
200	2.00	-0.05	0.05	25.0
300	3.00	-0.05	0.05	25.0
400	4.00	-0.05	0.05	25.0
500	5.00	-0.05	0.05	25.0
600	6.00	-0.05	0.05	25.0

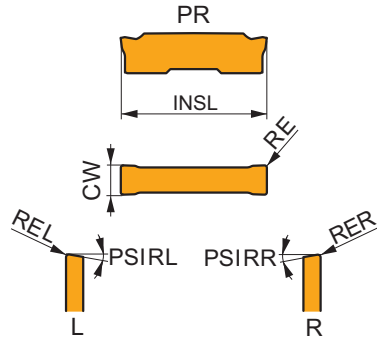

Suitability and starting values for cutting speed (vc) and feed (f). Refer to our Machining Calculator app for further calculations.

Product	RE (mm)	P		M		K		N		S		H		PSIRR (°)	PSIRL (°)
		vc (m/min)	f (mm/rev)	vc (m/min)	f (mm/rev)	vc (m/min)	f (mm/rev)	vc (m/min)	f (mm/rev)	vc (m/min)	f (mm/rev)	vc (m/min)	f (mm/rev)		

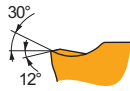

PR geometry with negative T-land, first choice for difficult grooving and parting-off, and continuous to interrupted cuts.

GL2-D200M02-PR:G8330	0.2	130	0.10	75	0.09	120	0.10	-	-	-	-	-	-	-	-
GL2-D200M02-PR:T7325	0.2	150	0.10	115	0.09	140	0.10	-	-	-	-	-	-	-	-
GL3-D300M02-PR:G8330	0.2	130	0.12	75	0.11	120	0.12	-	-	-	-	-	-	-	-
GL3-D300M02-PR:T7325	0.2	150	0.12	115	0.11	140	0.12	-	-	-	-	-	-	-	-
GL4-D400M02-PR:G8330	0.2	130	0.15	75	0.14	120	0.15	-	-	-	-	-	-	-	-
GL4-D400M02-PR:T7325	0.2	150	0.15	115	0.14	140	0.15	-	-	-	-	-	-	-	-
GL5-D500M04-PR:G8330	0.4	130	0.18	75	0.16	120	0.18	-	-	-	-	-	-	-	-
GL6-D600M04-PR:G8330	0.4	130	0.18	75	0.16	120	0.18	-	-	-	-	-	-	-	-

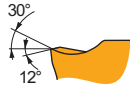

R-PR right-handed geometry with negative T-land, first choice for difficult bars parting-off, and continuous to interrupted cuts.

GL2-D200G02R06-PR:G8330	0.2	130	0.10	75	0.09	120	0.10	-	-	-	-	6	-
GL2-D200G02R12-PR:G8330	0.2	130	0.10	75	0.09	120	0.10	-	-	-	-	12	-
GL3-D300G02R06-PR:G8330	0.2	130	0.12	75	0.11	120	0.12	-	-	-	-	6	-
GL3-D300G02R12-PR:G8330	0.2	130	0.12	75	0.11	120	0.12	-	-	-	-	12	-
GL4-D400G02R06-PR:G8330	0.2	130	0.15	75	0.14	120	0.15	-	-	-	-	6	-
GL4-D400G02R12-PR:G8330	0.2	130	0.15	75	0.14	120	0.15	-	-	-	-	12	-

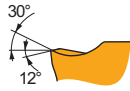

L-PR left-handed geometry with negative T-land, first choice for difficult bars parting-off, and continuous to interrupted cuts.

GL2-D200G02L06-PR:G8330	0.2	130	0.10	75	0.09	120	0.10	-	-	-	-	-	6
GL2-D200G02L12-PR:G8330	0.2	130	0.10	75	0.09	120	0.10	-	-	-	-	-	12
GL3-D300G02L06-PR:G8330	0.2	130	0.12	75	0.11	120	0.12	-	-	-	-	-	6
GL3-D300G02L12-PR:G8330	0.2	130	0.12	75	0.11	120	0.12	-	-	-	-	-	12
GL4-D400G02L06-PR:G8330	0.2	130	0.15	75	0.14	120	0.15	-	-	-	-	-	6
GL4-D400G02L12-PR:G8330	0.2	130	0.15	75	0.14	120	0.15	-	-	-	-	-	12

GL. S - PM



	CW (mm)	CWTOLL (mm)	CWTOLU (mm)	INSL (mm)
300	3.00	-0.05	0.05	24.5
400	4.00	-0.05	0.05	24.3

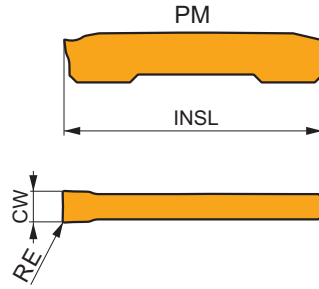

Suitability and starting values for cutting speed (vc) and feed (f). Refer to our Machining Calculator app for further calculations.

Product	RE (mm)	P		M		K		N		S		H		PSIRR (°)	PSIRL (°)
		vc (m/min)	f (mm/rev)	vc (m/min)	f (mm/rev)	vc (m/min)	f (mm/rev)	vc (m/min)	f (mm/rev)	vc (m/min)	f (mm/rev)	vc (m/min)	f (mm/rev)		

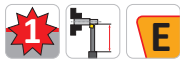
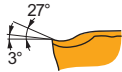

PM geometry with highly positive rake on single sided insert, first choice for deep parting-off, and continuous to slightly interrupted cuts.

GL3-S300M02-PM:G8330	0.2	130	0.10	75	0.09	120	0.10	390	0.12	30	0.07	-	-	-	-
GL4-S400M02-PM:G8330	0.2	130	0.12	75	0.11	120	0.12	390	0.14	30	0.10	-	-	-	-

GL. S - PR



	CW (mm)	CWTOLL (mm)	CWTOLU (mm)	INSL (mm)
300	3.00	-0.05	0.05	24.5
400	4.00	-0.05	0.05	24.3

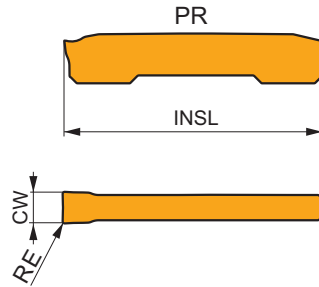

Suitability and starting values for cutting speed (vc) and feed (f). Refer to our Machining Calculator app for further calculations.

Product	RE (mm)	P		M		K		N		S		H		PSIRR (°)	PSIRL (°)
		vc (m/min)	f (mm/rev)	vc (m/min)	f (mm/rev)	vc (m/min)	f (mm/rev)	vc (m/min)	f (mm/rev)	vc (m/min)	f (mm/rev)	vc (m/min)	f (mm/rev)		

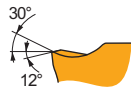

PR geometry with negative T-land on single sided insert, first choice for difficult deep grooving and parting-off, and continuous to interrupted cuts.

GL3-S300M02-PR:G8330	0.2	130	0.12	75	0.11	120	0.12	-	-	-	-	-	-	-	-
GL4-S400M02-PR:G8330	0.2	130	0.15	75	0.14	120	0.15	-	-	-	-	-	-	-	-

GL. D - GM



	CW (mm)	CWTOLL (mm)	CWTOLU (mm)	INSL (mm)
200	2.00	-0.05	0.05	25.0
300	3.00	-0.05	0.05	25.0
400	4.00	-0.05	0.05	25.0
500	5.00	-0.05	0.05	25.0
600	6.00	-0.05	0.05	25.0
800	8.00	-0.05	0.05	25.0

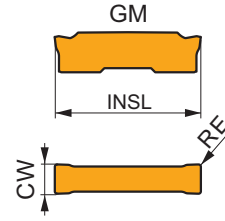

Suitability and starting values for cutting speed (vc), feed (f) and depth of cut (ap). Refer to our Machining Calculator app for further calculations.

Product	RE (mm)	P			M			K			N			S			H		
		vc (m/min)	f (mm/rev)	ap (mm)	vc (m/min)	f (mm/rev)	ap (mm)	vc (m/min)	f (mm/rev)	ap (mm)	vc (m/min)	f (mm/rev)	ap (mm)	vc (m/min)	f (mm/rev)	ap (mm)	vc (m/min)	f (mm/rev)	ap (mm)



GM versatile geometry for grooving and longitudinal turning, and continuous to interrupted cuts.

GL2-D200M02-GM:G8330	0.2	190	0.10	0.8	110	0.09	0.8	180	0.10	0.8	-	-	-	45	0.08	0.6	-	-	-
GL2-D200M02-GM:T7325	0.2	220	0.10	0.8	170	0.09	0.8	205	0.10	0.8	-	-	-	70	0.08	0.6	-	-	-
GL3-D300M02-GM:G8330	0.2	150	0.20	1.0	90	0.18	1.0	140	0.20	1.0	-	-	-	35	0.14	0.8	-	-	-
GL3-D300M02-GM:T7325	0.2	175	0.20	1.0	135	0.18	1.0	165	0.20	1.0	-	-	-	55	0.14	0.8	-	-	-
GL3-D300M04-GM:G8330	0.4	160	0.20	1.0	95	0.18	1.0	150	0.20	1.0	-	-	-	40	0.14	0.8	-	-	-
GL3-D300M04-GM:T7325	0.4	185	0.20	1.0	140	0.18	1.0	175	0.20	1.0	-	-	-	60	0.14	0.8	-	-	-
GL4-D400M04-GM:G8330	0.4	150	0.25	1.2	90	0.23	1.2	140	0.25	1.2	-	-	-	35	0.18	1.0	-	-	-
GL4-D400M04-GM:T7325	0.4	170	0.25	1.2	130	0.23	1.2	160	0.25	1.2	-	-	-	55	0.18	1.0	-	-	-
GL4-D400M08-GM:G8330	0.8	180	0.25	1.2	105	0.23	1.2	170	0.25	1.2	-	-	-	45	0.18	1.0	-	-	-
GL4-D400M08-GM:T7325	0.8	200	0.25	1.2	155	0.23	1.2	190	0.25	1.2	-	-	-	65	0.18	1.0	-	-	-
GL5-D500M08-GM:G8330	0.8	170	0.30	1.2	100	0.27	1.2	160	0.30	1.2	-	-	-	40	0.21	1.0	-	-	-
GL5-D500M08-GM:T7325	0.8	190	0.30	1.2	145	0.27	1.2	180	0.30	1.2	-	-	-	60	0.21	1.0	-	-	-
GL6-D600M08-GM:G8330	0.8	170	0.30	1.2	100	0.27	1.2	160	0.30	1.2	-	-	-	40	0.21	1.0	-	-	-
GL6-D600M08-GM:T7325	0.8	190	0.30	1.2	145	0.27	1.2	180	0.30	1.2	-	-	-	60	0.21	1.0	-	-	-
GL6-D800M08-GM:G8330 ¹⁾	0.8	170	0.30	1.2	100	0.27	1.2	160	0.30	1.2	-	-	-	40	0.21	1.2	-	-	-

¹⁾ Usable only in holders with CDX ≥ 24.

GL. D - MM



	CW (mm)	CWTOLL (mm)	CWTOLU (mm)	INSL (mm)
200	2.00	-0.05	0.05	25.0
300	3.00	-0.05	0.05	25.0
400	4.00	-0.05	0.05	25.0
500	5.00	-0.05	0.05	26.0
600	6.00	-0.05	0.05	26.0

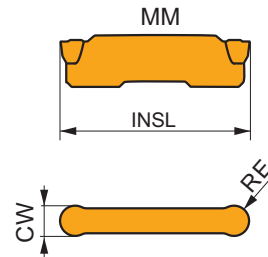

Suitability and starting values for cutting speed (vc), feed (f) and depth of cut (ap). Refer to our Machining Calculator app for further calculations.

Product	RE (mm)	P			M			K			N			S			H		
		vc (m/min)	f (mm/rev)	ap (mm)	vc (m/min)	f (mm/rev)	ap (mm)	vc (m/min)	f (mm/rev)	ap (mm)	vc (m/min)	f (mm/rev)	ap (mm)	vc (m/min)	f (mm/rev)	ap (mm)	vc (m/min)	f (mm/rev)	ap (mm)



MM geometry, with full radius shape for copy profiling and longitudinal turning, and continuous to interrupted cuts.

GL2-D200MMO-MM:G8330	1.0	250	0.10	1.0	150	0.09	1.0	235	0.10	1.0	-	-	-	60	0.08	0.8	-	-	-
GL2-D200MMO-MM:T7325	1.0	285	0.10	1.0	220	0.09	1.0	270	0.10	1.0	-	-	-	90	0.08	0.8	-	-	-
GL3-D300MMO-MM:G8330	1.5	210	0.20	1.2	125	0.18	1.2	195	0.20	1.2	-	-	-	50	0.14	1.0	-	-	-
GL3-D300MMO-MM:T7325	1.5	240	0.20	1.2	185	0.18	1.2	225	0.20	1.2	-	-	-	75	0.14	1.0	-	-	-
GL4-D400MMO-MM:G8330	2.0	220	0.20	1.2	130	0.18	1.2	205	0.20	1.2	-	-	-	55	0.14	1.0	-	-	-
GL4-D400MMO-MM:T7325	2.0	250	0.20	1.2	195	0.18	1.2	235	0.20	1.2	-	-	-	80	0.14	1.0	-	-	-
GL5-D500MMO-MM:G8330	2.5	205	0.25	1.2	120	0.23	1.2	190	0.25	1.2	-	-	-	50	0.18	1.0	-	-	-
GL5-D500MMO-MM:T7325	2.5	235	0.25	1.2	180	0.23	1.2	220	0.25	1.2	-	-	-	75	0.18	1.0	-	-	-
GL6-D600MMO-MM:G8330	3.0	195	0.30	1.2	115	0.27	1.2	185	0.30	1.2	-	-	-	45	0.21	1.0	-	-	-
GL6-D600MMO-MM:T7325	3.0	220	0.30	1.2	170	0.27	1.2	205	0.30	1.2	-	-	-	70	0.21	1.0	-	-	-

LFMX – BLADES & ACCESSORIES NAVIGATOR

INSERT SEAT	1.60	2.00	3.00	4.00	5.00	6.35
XLCFN B Blades H = 26 mm H = 32; 45 mm						
XLCF(NRL) BS MS Blades						
Cutting width (mm)	1.5/1.6	2.0/2.2	3.1	4.1	5.1	6.35
Parting-off inserts (sharp / with T-land)	 F1 F2	 F1 F2 M2	 F1 F2 M2	 F1 F2 M2	 F2	 F2

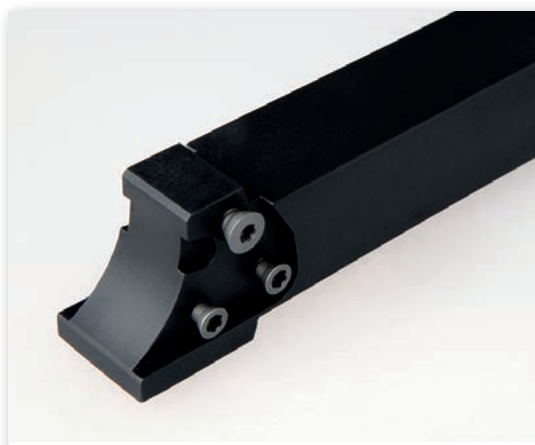

MS-EN

- Modular Tool Holder
- Shank sizes:
20 × 20, 25 × 25, 32 × 32 mm



DU, D

- Tool Holder Block
- Shank sizes:
20 × 20, 25 × 23, 25 × 32, 32 × 29, 25 × 30 mm

XLCFN B

P
M
K
N
S
H

PRAMET



Double-Ended Parting-off Blade for LFMX Inserts

Blade for parting-off applications Suited for single-sided LFMX inserts. Can be fitted into the DU Pramet basic holders. Blade treated for longer tool life.

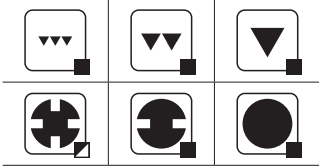
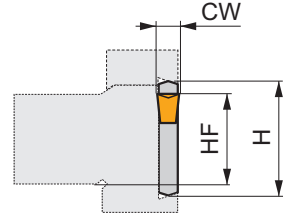
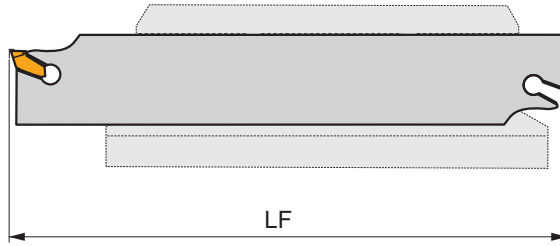
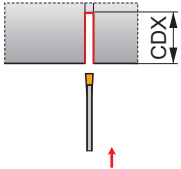

Product	HF	H	LF	CW	CDX	kg	G	KV
	(mm)	(mm)	(mm)	(mm)	(mm)			
N	XLCFN 2601 J 1.60	21.4	26	110	1.50	0.06	G132	KV
	XLCFN 2601 J 2.00	21.4	26	110	2.00	0.07	G1061	KV
	XLCFN 2602 J 3.00	21.4	26	110	3.10	0.08	G1001	KV
	XLCFN 2603 J 4.00	21.4	26	110	4.10	0.10	G1002	KV
	XLCFN 3201 M 1.60	25	32	150	1.50	0.11	G132	KV
	XLCFN 3201 M 2.00	25	32	150	2.00	0.11	G1061	KV
	XLCFN 3202 M 3.00	25	32	150	3.10	0.08	G1001	KV
	XLCFN 3203 M 4.00	25	32	150	4.10	0.14	G1002	KV
	XLCFN 3204 M 5.00	25	32	150	5.10	0.18	G1004	KV
	XLCFN 3205 M 6.35	25	32	150	6.35	0.21	G1005	KV
	XLCFN 4502 S 3.00	32	45	250	3.10	0.25	G1001	KV
	XLCFN 4503 S 4.00	32	45	250	4.10	0.33	G1002	KV
	XLCFN 4504 S 5.00	32	45	250	5.10	0.41	G1004	KV
	XLCFN 4505 S 6.35	32	45	250	6.35	0.48	G1005	KV

G1001	LFMX 3.1-	-
G1002	LFMX 4.1-	-
G1004	LFMX 5.1-	-
G1005	LFMX 6.35-	-
G1061	LFMX 2.0-	LFMX 2.2-
G132	LFMX 1.5-	LFMX 1.6-

KV	KV 5x70

XLCF(NRL) BS

P
M
K
N
S
H

PRAMET



Radial Grooving Blade for Modular MS-EN Tool Holder for LFMX Inserts

Modular grooving blade for grooving with single-sided LFMX inserts. Suited for grooving or parting-off (max. 25 mm cutting depth) applications. Blades treated for longer tool life.

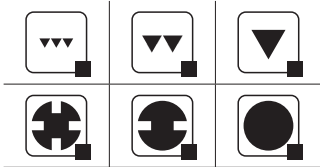
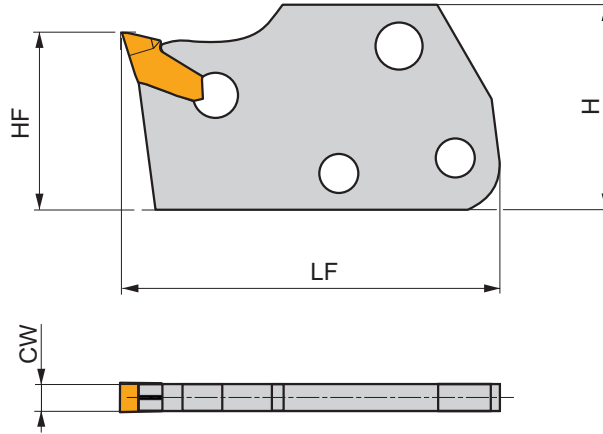
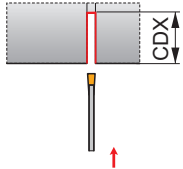

Product	HF	H	LF	CW	CDX	kg			
	(mm)	(mm)	(mm)	(mm)	(mm)				
R	XLCFR 160115-1.60	12	25	35	1.50	15	0.03	GI132	KV
	XLCFR 160115-2.00	12	25	35	2.00	15	0.01	GI061	KV
	XLCFR 250115-1.60	24	29	40	1.50	15	0.01	GI132	KV
	XLCFR 250115-2.00	24	29	40	2.00	15	0.05	GI061	KV
L	XLCFL 160115-1.60	12	25	35	1.50	15	0.03	GI132	KV
	XLCFL 160115-2.00	12	25	35	2.00	15	0.04	GI061	KV
	XLCFL 250115-1.60	24	29	40	1.50	15	0.04	GI132	KV
	XLCFL 250115-2.00	24	29	40	2.00	15	0.05	GI061	KV
N	XLCFN 160215-3.00	12	25	35	3.10	15	0.01	GI001	KV
	XLCFN 160220-3.00	12	25	40	3.10	20	0.04	GI001	KV
	XLCFN 250215-3.00	24	29	40	3.10	15	0.04	GI001	KV
	XLCFN 250225-3.00	24	29	50	3.10	25	0.02	GI001	KV
	XLCFN 250315-4.00	24	29	40	4.10	15	0.04	GI002	KV
	XLCFN 250325-4.00	24	29	50	4.10	25	0.04	GI002	KV
	XLCFN 250425-5.00	24	29	50	5.10	25	0.04	GI004	KV
XLCFN 250525-6.35	24	29	50	6.35	25	0.07	GI005	KV	

GI001	LFMX 3.1-	-
GI002	LFMX 4.1-	-
GI004	LFMX 5.1-	-
GI005	LFMX 6.35-	-
GI061	LFMX 2.0-	LFMX 2.2-
GI132	LFMX 1.5-	LFMX 1.6-

KV	KV 5x70

LFMX - F1



	CW	CWTOLL	CWTOLU	BW
	(mm)	(mm)	(mm)	(mm)
1.5	1.50	-0.03	0.03	1.30
1.6	1.60	-0.03	0.03	1.30
2.0	2.00	-0.03	0.03	1.60
3.1	3.10	-0.04	0.04	2.60
4.1	4.10	-0.04	0.04	3.60

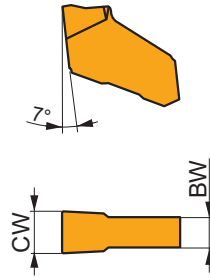

Suitability and starting values for cutting speed (vc) and feed (f). Refer to our Machining Calculator app for further calculations.

Product		RE (mm)	P		M		K		N		S		H		PSIRR (°)	PSIRL (°)
			vc (m/min)	f (mm/rev)	vc (m/min)	f (mm/rev)	vc (m/min)	f (mm/rev)	vc (m/min)	f (mm/rev)	vc (m/min)	f (mm/rev)				



EN-F1 geometry for parting-off and grooving, and continuous cuts.

LFMX 1.5-.16ENF1:T8330	●	0.2	130	0.08	75	0.07	120	0.08	—	—	—	—	—	—	—	—
LFMX 1.6-.16ENF1:T8330	●	0.2	130	0.08	75	0.07	120	0.08	—	—	—	—	—	—	—	—
LFMX 2.0-.16ENF1:T8330	●	0.2	130	0.08	75	0.07	120	0.08	—	—	—	—	—	—	—	—
LFMX 3.1-.20ENF1:T8330	●	0.2	130	0.10	75	0.09	120	0.10	—	—	—	—	—	—	—	—
LFMX 4.1-.20ENF1:T8330	●	0.2	130	0.10	75	0.09	120	0.10	—	—	—	—	—	—	—	—

LFMX - F2



	CW	CWTOLL	CWTOLU	BW
	(mm)	(mm)	(mm)	(mm)
1.6	1.60	-0.03	0.03	1.30
2.0	2.00	-0.03	0.03	1.60
3.1	3.10	-0.04	0.04	2.60
4.1	4.10	-0.04	0.04	3.60
5.1	5.10	-0.04	0.04	4.60
6.35	6.35	-0.04	0.04	5.80

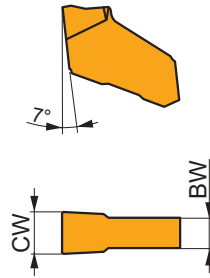

Suitability and starting values for cutting speed (vc) and feed (f). Refer to our Machining Calculator app for further calculations.

Product		RE (mm)	P		M		K		N		S		H		PSIRR (°)	PSIRL (°)
			vc (m/min)	f (mm/rev)	vc (m/min)	f (mm/rev)	vc (m/min)	f (mm/rev)	vc (m/min)	f (mm/rev)	vc (m/min)	f (mm/rev)				

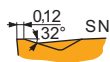
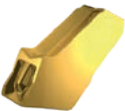

SN-F2 geometry for parting-off and grooving, and continuous cuts.

LFMX 1.6-.16SNF2:T8330	●	0.2	130	0.10	75	0.09	120	0.10	—	—	—	—	—	—	—	—
LFMX 2.0-.16SNF2:6640	●	0.2	150	0.10	90	0.09	140	0.10	—	—	—	—	—	—	—	—
LFMX 2.0-.16SNF2:T8330	●	0.2	130	0.10	75	0.09	120	0.10	—	—	—	—	—	—	—	—
LFMX 3.1-.20SNF2:6640	●	0.2	150	0.10	90	0.09	140	0.10	—	—	—	—	—	—	—	—
LFMX 3.1-.20SNF2:T8330	●	0.2	130	0.10	75	0.09	120	0.10	—	—	—	—	—	—	—	—
LFMX 4.1-.20SNF2:T8330	●	0.2	130	0.12	75	0.11	120	0.12	—	—	—	—	—	—	—	—
LFMX 5.1-.20SNF2:T8330	●	0.2	130	0.12	75	0.11	120	0.12	—	—	—	—	—	—	—	—
LFMX 6.35-.20SNF2:T8330	●	0.2	130	0.15	75	0.14	120	0.15	—	—	—	—	—	—	—	—

Suitability and starting values for cutting speed (vc) and feed (f). Refer to our Machining Calculator app for further calculations.

Product	RE (mm)	P		M		K		N		S		H		PSIRR (°)	PSIRL (°)
		vc (m/min)	f (mm/rev)	vc (m/min)	f (mm/rev)	vc (m/min)	f (mm/rev)	vc (m/min)	f (mm/rev)	vc (m/min)	f (mm/rev)	vc (m/min)	f (mm/rev)		

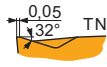
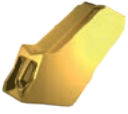

TN-F2 geometry for parting-off and grooving, and continuous cuts.

LFMX 3.1-.20TNF2:6640	●	0.2	150	0.10	90	0.09	140	0.10	-	-	-	-	-	-	-
LFMX 3.1-.20TNF2:T8330	●	0.2	130	0.10	75	0.09	120	0.10	-	-	-	-	-	-	-
LFMX 4.1-.20TNF2:T8330	●	0.2	130	0.12	75	0.11	120	0.12	-	-	-	-	-	-	-

LFMX - M2



	CW (mm)	CWTOLL (mm)	CWTOLU (mm)	BW (mm)
2.0	2.00	-0.03	0.03	1.60
2.2	2.20	-0.03	0.03	1.60
3.1	3.10	-0.04	0.04	2.60
4.1	4.10	-0.04	0.04	3.60
5.1	5.10	-0.04	0.04	4.60
6.35	6.35	-0.04	0.04	5.80

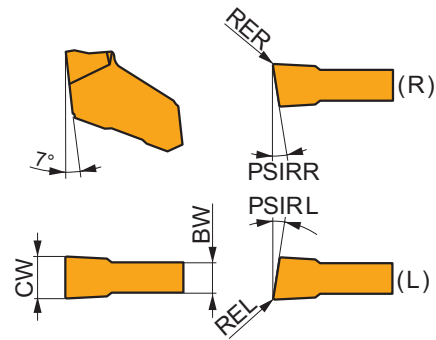

Suitability and starting values for cutting speed (vc) and feed (f). Refer to our Machining Calculator app for further calculations.

Product	RE (mm)	P		M		K		N		S		H		PSIRR (°)	PSIRL (°)
		vc (m/min)	f (mm/rev)	vc (m/min)	f (mm/rev)	vc (m/min)	f (mm/rev)	vc (m/min)	f (mm/rev)	vc (m/min)	f (mm/rev)	vc (m/min)	f (mm/rev)		

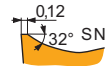

SN-M2 geometry for parting-off and grooving, and continuous to slightly interrupted cuts.

LFMX 2.0-.16SNM2:6640	●	0.2	150	0.11	90	0.10	140	0.11	-	-	-	-	-	-	-
LFMX 2.0-.16SNM2:T8330	●	0.2	130	0.11	75	0.10	120	0.11	-	-	-	-	-	-	-
LFMX 2.2-.16SNM2:6640	●	0.2	150	0.11	90	0.10	140	0.11	-	-	-	-	-	-	-
LFMX 2.2-.16SNM2:T8330	●	0.2	130	0.11	75	0.10	120	0.11	-	-	-	-	-	-	-
LFMX 3.1-.20SNM2:6640	●	0.2	150	0.15	90	0.14	140	0.15	-	-	-	-	-	-	-
LFMX 3.1-.20SNM2:T8330	●	0.2	130	0.15	75	0.14	120	0.15	-	-	-	-	-	-	-
LFMX 4.1-.20SNM2:6640	●	0.2	150	0.15	90	0.14	140	0.15	-	-	-	-	-	-	-
LFMX 4.1-.20SNM2:T8330	●	0.2	130	0.15	75	0.14	120	0.15	-	-	-	-	-	-	-
LFMX 5.1-.20SNM2:6640	●	0.2	150	0.20	90	0.18	140	0.20	-	-	-	-	-	-	-
LFMX 5.1-.20SNM2:T8330	●	0.2	130	0.20	75	0.18	120	0.20	-	-	-	-	-	-	-
LFMX 6.35-.20SNM2:6640	●	0.2	150	0.20	90	0.18	140	0.20	-	-	-	-	-	-	-
LFMX 6.35-.20SNM2:T8330	●	0.2	130	0.20	75	0.18	120	0.20	-	-	-	-	-	-	-

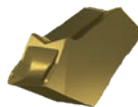

SR-M2 geometry, with right-handed design, for parting-off, and continuous to slightly interrupted cuts.

LFMX 2.0-.16SR12M2:T8330	●	0.2	130	0.09	75	0.08	120	0.09	-	-	-	-	12	-
LFMX 2.0-.16SR6M2:T8330	●	0.2	130	0.09	75	0.08	120	0.09	-	-	-	-	6	-
LFMX 3.1-.20SR8M2:T8330	●	0.2	130	0.11	75	0.10	120	0.11	-	-	-	-	8	-
LFMX 4.1-.20SR8M2:T8330	●	0.2	130	0.15	75	0.14	120	0.15	-	-	-	-	8	-

Suitability and starting values for cutting speed (vc) and feed (f). Refer to our Machining Calculator app for further calculations.

Product	RE (mm)	P		M		K		N		S		H		PSIRR (°)	PSIRL (°)
		vc (m/min)	f (mm/rev)	vc (m/min)	f (mm/rev)	vc (m/min)	f (mm/rev)	vc (m/min)	f (mm/rev)	vc (m/min)	f (mm/rev)	vc (m/min)	f (mm/rev)		

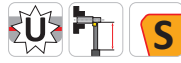
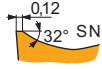
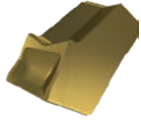

SL-M2 geometry, with left-handed design, for parting-off, and continuous to slightly interrupted cuts.

LFMX 2.0-.16SL12M2:T8330	● 0.2	■ 130	■ 0.09	■ 75	■ 0.08	■ 120	■ 0.09	—	—	—	—	—	—	—	12
LFMX 2.0-.16SL6M2:T8330	● 0.2	■ 130	■ 0.09	■ 75	■ 0.08	■ 120	■ 0.09	—	—	—	—	—	—	—	6
LFMX 3.1-.20SL8M2:T8330	● 0.2	■ 130	■ 0.11	■ 75	■ 0.10	■ 120	■ 0.11	—	—	—	—	—	—	—	8
LFMX 4.1-.20SL8M2:T8330	● 0.2	■ 130	■ 0.15	■ 75	■ 0.14	■ 120	■ 0.15	—	—	—	—	—	—	—	8

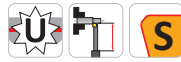
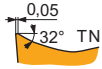

TN-M2 geometry for parting-off and grooving, and continuous to slightly interrupted cuts.

LFMX 3.1-.20TNM2:6640	● 0.2	■ 150	■ 0.15	■ 90	■ 0.14	■ 140	■ 0.15	—	—	—	—	—	—	—	—
LFMX 3.1-.20TNM2:T8330	● 0.2	■ 130	■ 0.15	■ 75	■ 0.14	■ 120	■ 0.15	—	—	—	—	—	—	—	—
LFMX 4.1-.20TNM2:6640	● 0.2	■ 150	■ 0.15	■ 90	■ 0.14	■ 140	■ 0.15	—	—	—	—	—	—	—	—
LFMX 4.1-.20TNM2:T8330	● 0.2	■ 130	■ 0.15	■ 75	■ 0.14	■ 120	■ 0.15	—	—	—	—	—	—	—	—

LFUX – BLADES & ACCESSORIES NAVIGATOR

	03	04	05	06		
XLCFN B LFUX						
H = 26 mm H = 32; 47 mm						
	3	4	5			
	LFUX	LFUX	LFUX	LFUX		



DU, D

- Tool Holder Block
- Shank sizes:
20 × 20, 25 × 23, 25 × 32, 32 × 29, 25 × 30 mm

XLCFN B LFUX

P
M
K
N
S
H

PRAMET



Double-Ended Parting-off Blade for LFUX Inserts

Blade for parting-off applications Suited for single sided LFUX inserts. Available in heights of 26, 32 or 47 mm. Can be fitted into the DU, D Pramet basic holders. Blade treated for longer tool life.

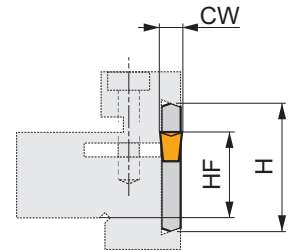
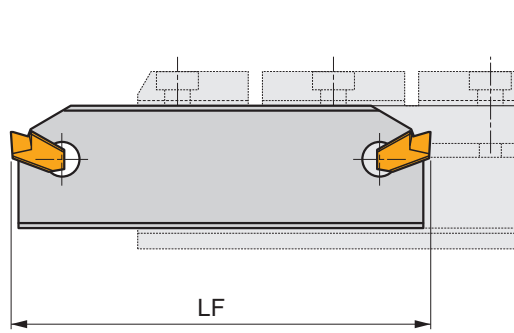
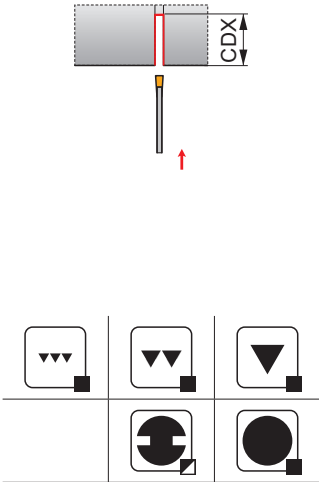

Product	HF	H	LF	CW	CDX	kg		
	(mm)	(mm)	(mm)	(mm)	(mm)			
N XLCFN 2603 J 03	21.4	26	110	3.10	37.5	0.06	GI018	KV
XLCFN 3202 M 03	25	32	150	3.10	50	0.11	GI018	KV
XLCFN 3203 M 04	25	32	150	4.10	50	0.15	GI019	KV
XLCFN 3204 M 05	25	32	150	5.10	60	0.17	GI020	KV
XLCFN 4704 S 05	38	47	270	5.10	100	0.46	GI020	KV
XLCFN 4705 S 06	38	47	270	6.10	100	0.50	GI021	KV

GI018	LFUX 0308..
GI019	LFUX 0408..
GI020	LFUX 0508..
GI021	LFUX 0608..

KV	KV 5x70

LFUX



	CW (mm)	BW (mm)	INSL (mm)
0308	3.00	2.51	11.5
0408	4.00	3.44	11.5
0508	5.00	4.30	11.5
0608	6.00	5.30	11.5

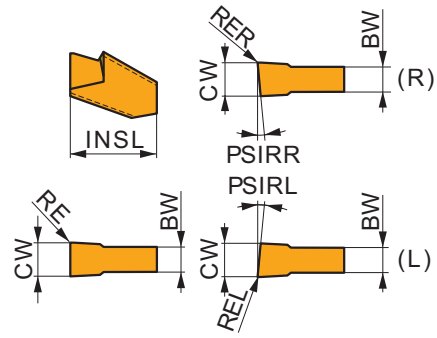

Suitability and starting values for cutting speed (vc) and feed (f). Refer to our Machining Calculator app for further calculations.

Product	RE (mm)	P		M		K		N		S		H		PSIRR (°)	PSIRL (°)
		vc (m/min)	f (mm/rev)	vc (m/min)	f (mm/rev)	vc (m/min)	f (mm/rev)	vc (m/min)	f (mm/rev)	vc (m/min)	f (mm/rev)	vc (m/min)	f (mm/rev)		



TN geometry for parting-off and grooving, and continuous to slightly interrupted cuts.

LFUX 030802TN:6640	0.2	150	0.10	–	–	140	0.10	–	–	–	–	–	–	–	–
LFUX 030802TN:T8330	0.2	130	0.10	–	–	120	0.10	–	–	–	–	–	–	–	–
LFUX 040802TN:6640	0.2	150	0.12	–	–	140	0.12	–	–	–	–	–	–	–	–
LFUX 040802TN:T8330	0.2	130	0.12	–	–	120	0.12	–	–	–	–	–	–	–	–
LFUX 050802TN:6640	0.2	150	0.15	–	–	140	0.15	–	–	–	–	–	–	–	–
LFUX 050802TN:T8330	0.2	130	0.15	–	–	120	0.15	–	–	–	–	–	–	–	–
LFUX 060802TN:6640	0.2	150	0.20	–	–	140	0.20	–	–	–	–	–	–	–	–
LFUX 060802TN:T8330	0.2	130	0.20	–	–	120	0.20	–	–	–	–	–	–	–	–



TR geometry, right-handed, for parting-off and continuous to slightly interrupted cuts.

LFUX 030800TR:6640	0.2	150	0.10	–	–	140	0.10	–	–	–	–	–	5	–
LFUX 030800TR:T8330	0.2	130	0.10	–	–	120	0.10	–	–	–	–	–	5	–
LFUX 040800TR:6640	0.2	150	0.12	–	–	140	0.12	–	–	–	–	–	5	–
LFUX 040800TR:T8330	0.2	130	0.12	–	–	120	0.12	–	–	–	–	–	5	–



TL geometry, left-handed, for parting-off and continuous to slightly interrupted cuts.

LFUX 030800TL:6640	0.2	150	0.10	–	–	140	0.10	–	–	–	–	–	–	5
LFUX 030800TL:T8330	0.2	130	0.10	–	–	120	0.10	–	–	–	–	–	–	5

MS-EN



Modular Tool Holder for Grooving and Parting-off Blades

Modular tool holder for BS type grooving and parting-off blades. Body treated for longer tool life.

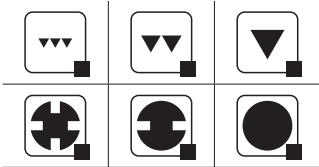
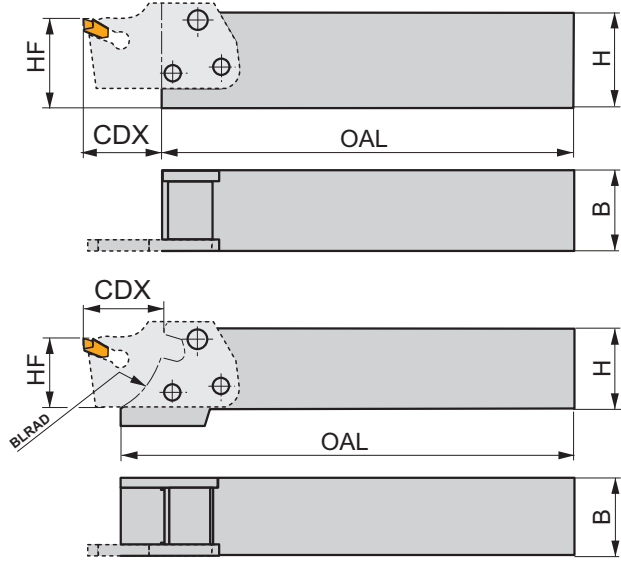
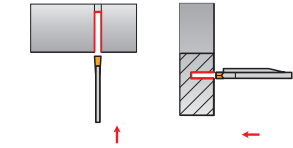

Product	HF (mm)	H (mm)	B (mm)	OAL (mm)	BLRAD (mm)	kg		
MS-EN-1212 F	12	12	12	75	-	0.12	GI006	ND4
MS-EN-1616 H	16	16	16	90	-	0.21	GI006	ND4
MS-EN-2020 K	20	20	20	115	-	0.23	GI003	ND5
MS-EN-2020 KS	20	20	20	129	25	0.42	GI060	ND5
MS-EN-2525 M	25	25	25	140	-	0.65	GI003	ND5
MS-EN-2525 MS	25	25	25	153	25	0.73	GI060	ND5
MS-EN-3225 P	32	32	25	160	-	0.95	GI003	ND5
MS-EN-3225 PS	32	32	25	174	25	1.00	GI060	ND5

GI003	XLC.. 25..15...	XLC.. 25..25...	GL.BS	XLXFL 25...
GI006	XLCF. 16..15...	XLCF. 16..20...	-	-
GI060	XLC.. 25..15...	XLC.. 25..25...	GL.BS	-

ND4	US 4011-T15P	3.5	M 4	10.6	-	-	-	-	FLAG T15P
ND5	US 45013-T20P	5.0	M 5	13	US 46017-T20P	5.0	M6	17	FLAG T20P

ND4 = 3 x US 4011-T15P; ND5 = 2 x US 45013-T20P

DU, D



Tool Holder Block for Parting-off Blades

Tool holder to fit GL or XLC. blades for parting-off. Body treated for longer tool life.

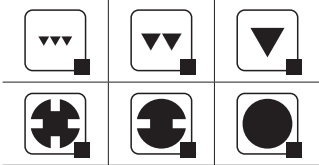
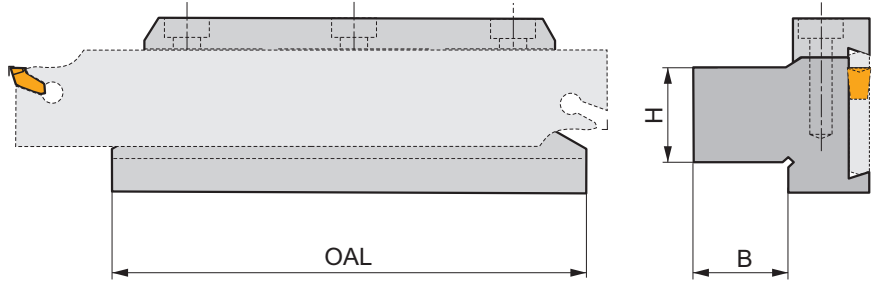
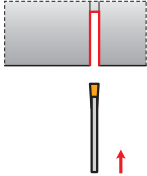

Product	H (mm)	B (mm)	OAL (mm)	kg		
26-DU 2020	20	20	90	0.76	GI007	ND2
26-D 2020	20	20	100	0.82	GI007	ND2
32-DU 2523	25	23	110	1.06	GI008	ND2
32-DU 2532	25	32	110	1.24	GI008	ND2
32-D 2530	25	30	115	1.28	GI008	ND2
32-DU 3229	32	29	110	1.25	GI008	ND2
45-DU 3229	32	29	110	1.50	GI009	ND7
45-DU 4036	40	36	110	2.05	GI009	ND7
47-D 4040	40	40	150	3.84	GI091	ND3

GI007	XLC.N 26..	GL.-S26.B.
GI008	XLC.N 32..	GL.-S32.B.
GI009	XLC.N 45..	-
GI091	XLC.N 47..	-

ND2	HS 0625	6.0	M 6	25	HXK 5
ND3	HS 1030	8.0	M 10	30	HXK 8
ND7	HS 0630	6.0	M 6	30	HXK 5

FACE GROOVING TOOLS

INSERT SEAT	LNMX 3.00	GL3	GL4	GL5	GL6	
NEW Face axial, Right 20 × 20 32 × 32		CDX 12 - 25 mm 	CDX 20 - 25 mm 	CDX 25 mm 	CDX 25 - 32 mm 	
NEW Face axial, Left 25 × 25 32 × 32		CDX 12 - 25 mm 	CDX 20 - 25 mm 	CDX 25 mm 	CDX 25 - 32 mm 	
NEW Face 90°, Right 25 × 25		CDX 15 - 25 mm 	CDX 20 - 25 mm 			
MS Blades	CDX 20 mm 					
Cutting width (mm)	3.1	3	4	5	6	8
Face grooving	 LFMX 	GM 	GM 	GM 	GM 	GM
Face turning Face profiling		GM MM	GM MM	GM MM	GM MM	GM

GLSF L-R AXIAL



PRAMET



Axial Face Grooving tool for GL inserts

Left handed axial face grooving tool holder for GL inserts. Suited for face grooving, turning and profiling applications. Body treated for longer tool life.

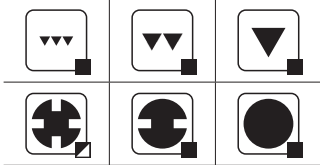
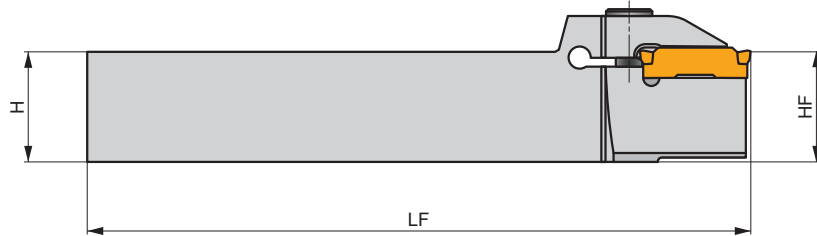
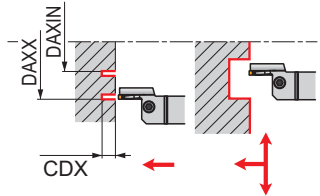

Product	⌀	H	B	WF	LF	CW	CDX	DAXX	DAXIN	kg		
	(mm)	(mm)	(mm)	(mm)	(mm)	(mm)	(mm)	(mm)	(mm)			
L GL3-S2525MFL-12-R035027	25	25	25	26	150	3.00	12	35	27	0.69	GI361	GL16
GL3-S2525MFL-15-R044033	25	25	25	26	150	3.00	15	44	33	0.68	GI361	GL16
GL3-S2525MFL-15-R055040	25	25	25	26	150	3.00	15	55	40	0.68	GI361	GL16
GL3-S2525MFL-20-R080051	25	25	25	26	150	3.00	20	80	51	0.65	GI361	GL16
GL3-S2525MFL-25-R110076	25	25	25	26	150	3.00	25	110	76	0.63	GI361	GL16
GL4-S2525MFL-20-R065050	25	25	25	26	150	4.00	20	65	50	0.71	GI362	GL16
GL4-S2525MFL-20-R095060	25	25	25	26	150	4.00	20	95	60	0.65	GI362	GL16
GL4-S2525MFL-25-R160090	25	25	25	26	150	4.00	25	160	90	0.63	GI362	GL16
GL4-S2525MFL-25-R400150	25	25	25	25.7	150	4.00	25	400	150	0.63	GI362	GL16
GL4-S2525MFL-25-R950380	25	25	25	25.7	150	4.00	25	950	380	0.63	GI362	GL16
GL5-S2525MFL-25-R095060	25	25	25	25.3	150	5.00	25	95	60	0.63	GI363	GL16
GL5-S2525MFL-25-R200090	25	25	25	25.3	150	5.00	25	200	90	0.63	GI363	GL16
GL5-S2525MFL-25-R950180	25	25	25	25.3	150	5.00	25	950	180	0.63	GI363	GL16
GL6-S2525MFL-25-R095060	25	25	25	25.4	150	6.00	25	95	60	0.69	GI364	GL16
GL6-S2525MFL-25-R200090	25	25	25	25.4	150	6.00	25	200	90	0.64	GI364	GL16
GL6-S2525MFL-25-R950180	25	25	25	25.4	150	6.00	25	950	180	0.64	GI364	GL16
GL6-S3232PFL-32-R200090	32	32	32	32.4	170	6.00	32	200	90	1.20	GI364	GL17
GL6-S3232PFL-32-R950180	32	32	32	32.4	170	6.00	32	950	180	1.20	GI364	GL17

GI361	GL3-GM	GL3-MM
GI362	GL4-GM	GL4-MM
GI363	GL5-GM	GL5-MM
GI364	GL6-GM	GL6-MM

GL16	HS 0620	6.0	M6	20	HXK 5
GL17	HS 0825	8.0	M8	25	HXK 6

GLSF R-L AXIAL

P
M
K
N
S
H

PRAMET

G







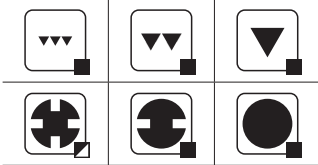
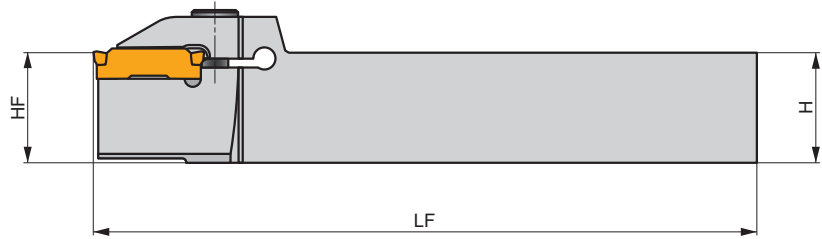
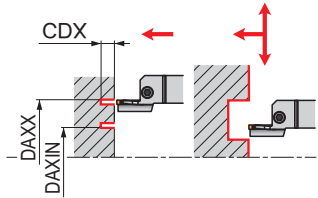

Axial Face Grooving tool for GL inserts

Right handed axial face grooving tool holder for GL inserts. Suited for face grooving, turning and profiling applications. Body treated for longer tool life.



Product	HF	H	B	WF	LF	CW	CDX	DAXX	DAXIN	kg		
	(mm)	(mm)	(mm)	(mm)	(mm)	(mm)	(mm)	(mm)	(mm)			
R GL3-S2020KFR-12-L035027	20	20	20	20.5	125	3.00	12	35	27	0.40	GI361	GL16
GL3-S2020KFR-15-L044033	20	20	20	20.5	125	3.00	15	44	33	0.39	GI361	GL16
GL3-S2020KFR-15-L055040	20	20	20	20.5	125	3.00	15	55	40	0.39	GI361	GL16
GL3-S2020KFR-20-L080051	20	20	20	20.5	125	3.00	20	80	51	0.38	GI361	GL16
GL3-S2525MFR-12-L035027	25	25	25	26	150	3.00	12	35	27	0.69	GI361	GL16
GL3-S2525MFR-15-L044033	25	25	25	26	150	3.00	15	44	33	0.68	GI361	GL16
GL3-S2525MFR-15-L055040	25	25	25	26	150	3.00	15	55	40	0.68	GI361	GL16
GL3-S2525MFR-20-L080051	25	25	25	26	150	3.00	20	80	51	0.65	GI361	GL16
GL3-S2525MFR-25-L110076	25	25	25	26	150	3.00	25	110	76	0.63	GI361	GL16
GL4-S2525MFR-20-L065050	25	25	25	26	150	4.00	20	65	50	0.66	GI362	GL16
GL4-S2525MFR-20-L095060	25	25	25	26	150	4.00	20	95	60	0.65	GI362	GL16
GL4-S2525MFR-25-L160090	25	25	25	26	150	4.00	25	160	90	0.63	GI362	GL16
GL4-S2525MFR-25-L400150	25	25	25	25.7	150	4.00	25	400	150	0.63	GI362	GL16
GL4-S2525MFR-25-L950380	25	25	25	25.7	150	4.00	25	950	380	0.63	GI362	GL16
GL5-S2525MFR-25-L095060	25	25	25	25.3	150	5.00	25	95	60	0.63	GI363	GL16
GL5-S2525MFR-25-L200090	25	25	25	25.3	150	5.00	25	200	90	0.63	GI363	GL16
GL5-S2525MFR-25-L950180	25	25	25	25.3	150	5.00	25	950	180	0.63	GI363	GL16
GL6-S2525MFR-25-L095060	25	25	25	25.4	150	6.00	25	95	60	0.64	GI364	GL16
GL6-S2525MFR-25-L200090	25	25	25	25.4	150	6.00	25	200	90	0.64	GI364	GL16
GL6-S2525MFR-25-L950180	25	25	25	25.4	150	6.00	25	950	180	0.64	GI364	GL16
GL6-S3232PFR-32-L200090	32	32	32	32.4	170	6.00	32	200	90	1.20	GI364	GL17
GL6-S3232PFR-32-L950180	32	32	32	32.4	170	6.00	32	950	180	1.21	GI364	GL17

		
GI361	GL3-GM	GL3-MM
GI362	GL4-GM	GL4-MM
GI363	GL5-GM	GL5-MM
GI364	GL6-GM	GL6-MM

		 Nm			
GL16	HS 0620	6.0	M6	20	HXX 5
GL17	HS 0825	8.0	M8	25	HXX 6

GLSG R-R AXIAL

P
M
K
N
S
H

PRAMET

G



Radial Face Grooving tool for GL inserts

Right handed radial face grooving tool holder for GL inserts. Suited for face grooving, turning and profiling applications. Body treated for longer tool life.

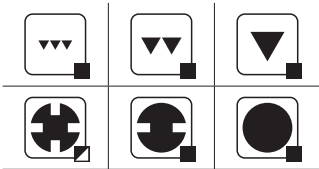
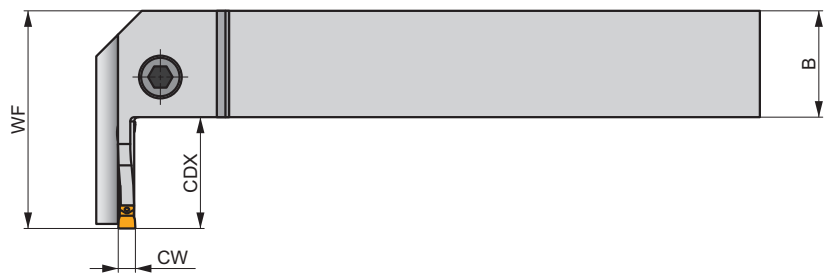
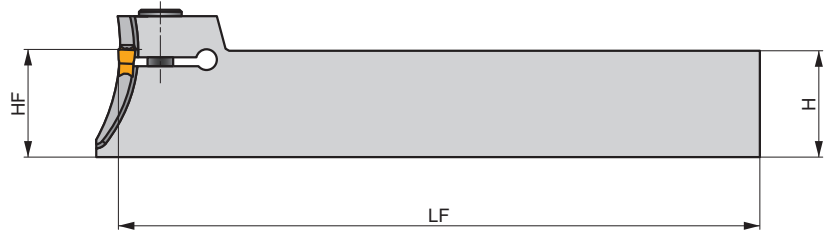
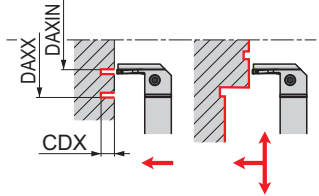

Product	HF	H	B	WF	LF	CW	CDX	DAXX	DAXIN	kg		
	(mm)	(mm)	(mm)	(mm)	(mm)	(mm)	(mm)	(mm)	(mm)			
GL3-S2525MGR-15-R044033	25	25	25	40.9	150	3.00	15	44	33	0.75	GI361	GL16
GL3-S2525MGR-15-R055040	25	25	25	40.9	150	3.00	15	55	40	0.75	GI361	GL16
GL3-S2525MGR-20-R080051	25	25	25	45.9	150	3.00	20	80	51	0.75	GI361	GL16
GL3-S2525MGR-25-R110076	25	25	25	50.9	150	3.00	25	110	76	0.75	GI361	GL16
GL4-S2525MGR-20-R065050	25	25	25	46	150	4.00	20	65	50	0.77	GI362	GL16
GL4-S2525MGR-25-R095060	25	25	25	51	150	4.00	25	95	60	0.76	GI362	GL16
GL4-S2525MGR-25-R160090	25	25	25	51	150	4.00	25	160	90	0.76	GI362	GL16
GL4-S2525MGR-25-R400150	25	25	25	51	150	4.00	25	400	150	0.75	GI362	GL16

	I	I
GI361	GL3-GM	GL3-MM
GI362	GL4-GM	GL4-MM

GL16	HS 0620	6.0	M6	20	HXK 5

GL. D - GM



	CW (mm)	CWTOLL (mm)	CWTOLU (mm)	INSL (mm)
200	2.00	-0.05	0.05	25.0
300	3.00	-0.05	0.05	25.0
400	4.00	-0.05	0.05	25.0
500	5.00	-0.05	0.05	25.0
600	6.00	-0.05	0.05	25.0
800	8.00	-0.05	0.05	25.0

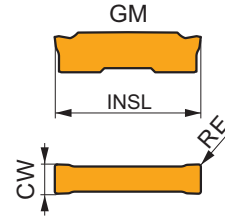

Suitability and starting values for cutting speed (vc), feed (f) and depth of cut (ap). Refer to our Machining Calculator app for further calculations.

Product	RE (mm)	P			M			K			N			S			H		
		vc (m/min)	f (mm/rev)	ap (mm)	vc (m/min)	f (mm/rev)	ap (mm)	vc (m/min)	f (mm/rev)	ap (mm)	vc (m/min)	f (mm/rev)	ap (mm)	vc (m/min)	f (mm/rev)	ap (mm)	vc (m/min)	f (mm/rev)	ap (mm)



GM versatile geometry for grooving and longitudinal turning, and continuous to interrupted cuts.

GL2-D200M02-GM:G8330	0.2	190	0.10	0.8	110	0.09	0.8	180	0.10	0.8	-	-	-	45	0.08	0.6	-	-	-
GL2-D200M02-GM:T7325	0.2	220	0.10	0.8	170	0.09	0.8	205	0.10	0.8	-	-	-	70	0.08	0.6	-	-	-
GL3-D300M02-GM:G8330	0.2	150	0.20	1.0	90	0.18	1.0	140	0.20	1.0	-	-	-	35	0.14	0.8	-	-	-
GL3-D300M02-GM:T7325	0.2	175	0.20	1.0	135	0.18	1.0	165	0.20	1.0	-	-	-	55	0.14	0.8	-	-	-
GL3-D300M04-GM:G8330	0.4	160	0.20	1.0	95	0.18	1.0	150	0.20	1.0	-	-	-	40	0.14	0.8	-	-	-
GL3-D300M04-GM:T7325	0.4	185	0.20	1.0	140	0.18	1.0	175	0.20	1.0	-	-	-	60	0.14	0.8	-	-	-
GL4-D400M04-GM:G8330	0.4	150	0.25	1.2	90	0.23	1.2	140	0.25	1.2	-	-	-	35	0.18	1.0	-	-	-
GL4-D400M04-GM:T7325	0.4	170	0.25	1.2	130	0.23	1.2	160	0.25	1.2	-	-	-	55	0.18	1.0	-	-	-
GL4-D400M08-GM:G8330	0.8	180	0.25	1.2	105	0.23	1.2	170	0.25	1.2	-	-	-	45	0.18	1.0	-	-	-
GL4-D400M08-GM:T7325	0.8	200	0.25	1.2	155	0.23	1.2	190	0.25	1.2	-	-	-	65	0.18	1.0	-	-	-
GL5-D500M08-GM:G8330	0.8	170	0.30	1.2	100	0.27	1.2	160	0.30	1.2	-	-	-	40	0.21	1.0	-	-	-
GL5-D500M08-GM:T7325	0.8	190	0.30	1.2	145	0.27	1.2	180	0.30	1.2	-	-	-	60	0.21	1.0	-	-	-
GL6-D600M08-GM:G8330	0.8	170	0.30	1.2	100	0.27	1.2	160	0.30	1.2	-	-	-	40	0.21	1.0	-	-	-
GL6-D600M08-GM:T7325	0.8	190	0.30	1.2	145	0.27	1.2	180	0.30	1.2	-	-	-	60	0.21	1.0	-	-	-
GL6-D800M08-GM:G8330 ¹⁾	0.8	170	0.30	1.2	100	0.27	1.2	160	0.30	1.2	-	-	-	40	0.21	1.2	-	-	-

¹⁾ Usable only in holders with CDX ≥ 24.

GL. D - MM



	CW (mm)	CWTOLL (mm)	CWTOLU (mm)	INSL (mm)
200	2.00	-0.05	0.05	25.0
300	3.00	-0.05	0.05	25.0
400	4.00	-0.05	0.05	25.0
500	5.00	-0.05	0.05	26.0
600	6.00	-0.05	0.05	26.0

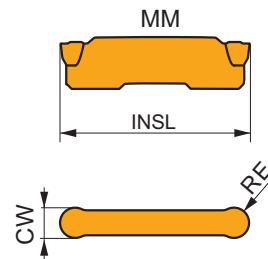

Suitability and starting values for cutting speed (vc), feed (f) and depth of cut (ap). Refer to our Machining Calculator app for further calculations.

Product	RE (mm)	P			M			K			N			S			H		
		vc (m/min)	f (mm/rev)	ap (mm)	vc (m/min)	f (mm/rev)	ap (mm)	vc (m/min)	f (mm/rev)	ap (mm)	vc (m/min)	f (mm/rev)	ap (mm)	vc (m/min)	f (mm/rev)	ap (mm)	vc (m/min)	f (mm/rev)	ap (mm)



MM geometry, with full radius shape for copy profiling and longitudinal turning, and continuous to interrupted cuts.

GL2-D200MMO-MM:G8330	1.0	250	0.10	1.0	150	0.09	1.0	235	0.10	1.0	-	-	-	60	0.08	0.8	-	-	-
GL2-D200MMO-MM:T7325	1.0	285	0.10	1.0	220	0.09	1.0	270	0.10	1.0	-	-	-	90	0.08	0.8	-	-	-
GL3-D300MMO-MM:G8330	1.5	210	0.20	1.2	125	0.18	1.2	195	0.20	1.2	-	-	-	50	0.14	1.0	-	-	-
GL3-D300MMO-MM:T7325	1.5	240	0.20	1.2	185	0.18	1.2	225	0.20	1.2	-	-	-	75	0.14	1.0	-	-	-
GL4-D400MMO-MM:G8330	2.0	220	0.20	1.2	130	0.18	1.2	205	0.20	1.2	-	-	-	55	0.14	1.0	-	-	-
GL4-D400MMO-MM:T7325	2.0	250	0.20	1.2	195	0.18	1.2	235	0.20	1.2	-	-	-	80	0.14	1.0	-	-	-
GL5-D500MMO-MM:G8330	2.5	205	0.25	1.2	120	0.23	1.2	190	0.25	1.2	-	-	-	50	0.18	1.0	-	-	-
GL5-D500MMO-MM:T7325	2.5	235	0.25	1.2	180	0.23	1.2	220	0.25	1.2	-	-	-	75	0.18	1.0	-	-	-
GL6-D600MMO-MM:G8330	3.0	195	0.30	1.2	115	0.27	1.2	185	0.30	1.2	-	-	-	45	0.21	1.0	-	-	-
GL6-D600MMO-MM:T7325	3.0	220	0.30	1.2	170	0.27	1.2	205	0.30	1.2	-	-	-	70	0.21	1.0	-	-	-

XLXFL BS AXIAL

P
M
K
N
S
H

PRAMET



Axial Grooving Blade for Modular MS-EN Tool Holder for LFMX Inserts

Modular grooving blade for grooving with single-sided LFMX inserts. Suited for axial grooving (max. 20 mm cutting depth) applications. Can be fitted to MS-EN tool holder. Blades treated for longer tool life.

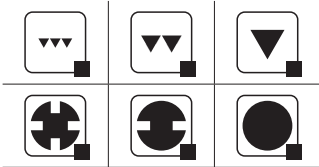
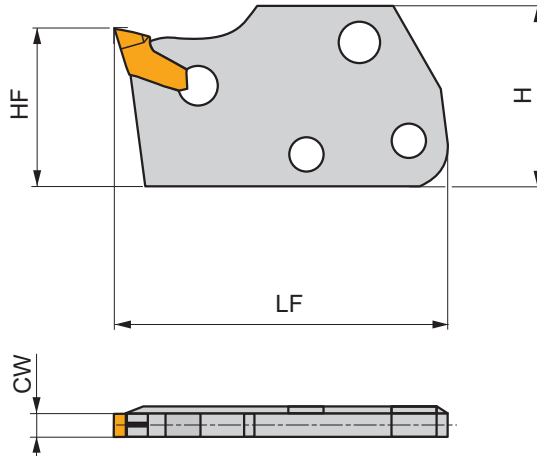
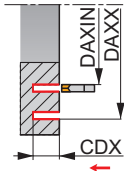

Product	H	HF	LF	CW	CDX	DAXIN	DAXX	kg	GI001	KV
	(mm)	(mm)	(mm)	(mm)	(mm)	(mm)	(mm)			
L XLXFL 250220-3.00-60	29	24	46	3.10	20	60	85	0.05	GI001	KV
XLXFL 250220-3.00-80	29	24	46	3.10	20	80	105	0.05	GI001	KV
XLXFL 250220-3.00-100	29	24	46	3.10	20	100	155	0.03	GI001	KV
XLXFL 250220-3.00-150	29	24	46	3.10	20	150	280	0.03	GI001	KV

LFMX - F1



	CW	CWTOLL	CWTOLU	BW
	(mm)	(mm)	(mm)	(mm)
1.5	1.50	-0.03	0.03	1.30
1.6	1.60	-0.03	0.03	1.30
2.0	2.00	-0.03	0.03	1.60
3.1	3.10	-0.04	0.04	2.60
4.1	4.10	-0.04	0.04	3.60

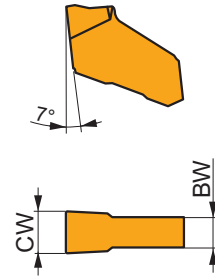

Suitability and starting values for cutting speed (vc) and feed (f). Refer to our Machining Calculator app for further calculations.

Product	RE (mm)	P		M		K		N		S		H		PSIRR (°)	PSIRL (°)
		vc (m/min)	f (mm/rev)	vc (m/min)	f (mm/rev)	vc (m/min)	f (mm/rev)	vc (m/min)	f (mm/rev)	vc (m/min)	f (mm/rev)	vc (m/min)	f (mm/rev)		

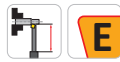

EN-F1 geometry for parting-off and grooving, and continuous cuts.

LFMX 1.5-.16ENF1:T8330	0.2	130	0.08	75	0.07	120	0.08	-	-	-	-	-	-	-	-
LFMX 1.6-.16ENF1:T8330	0.2	130	0.08	75	0.07	120	0.08	-	-	-	-	-	-	-	-
LFMX 2.0-.16ENF1:T8330	0.2	130	0.08	75	0.07	120	0.08	-	-	-	-	-	-	-	-
LFMX 3.1-.20ENF1:T8330	0.2	130	0.10	75	0.09	120	0.10	-	-	-	-	-	-	-	-
LFMX 4.1-.20ENF1:T8330	0.2	130	0.10	75	0.09	120	0.10	-	-	-	-	-	-	-	-

LFMX - F2



	CW	CWTOLL	CWTOLU	BW
	(mm)	(mm)	(mm)	(mm)
1.6	1.60	-0.03	0.03	1.30
2.0	2.00	-0.03	0.03	1.60
3.1	3.10	-0.04	0.04	2.60
4.1	4.10	-0.04	0.04	3.60
5.1	5.10	-0.04	0.04	4.60
6.35	6.35	-0.04	0.04	5.80

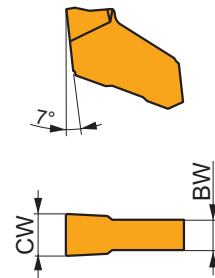

Suitability and starting values for cutting speed (vc) and feed (f). Refer to our Machining Calculator app for further calculations.

Product	RE (mm)	P		M		K		N		S		H		PSIRR (°)	PSIRL (°)
		vc (m/min)	f (mm/rev)	vc (m/min)	f (mm/rev)	vc (m/min)	f (mm/rev)	vc (m/min)	f (mm/rev)	vc (m/min)	f (mm/rev)	vc (m/min)	f (mm/rev)		

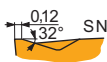
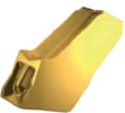

SN-F2 geometry for parting-off and grooving, and continuous cuts.

LFMX 1.6-.16SNF2:T8330	0.2	130	0.10	75	0.09	120	0.10	-	-	-	-	-	-	-	-
LFMX 2.0-.16SNF2:6640	0.2	150	0.10	90	0.09	140	0.10	-	-	-	-	-	-	-	-
LFMX 2.0-.16SNF2:T8330	0.2	130	0.10	75	0.09	120	0.10	-	-	-	-	-	-	-	-
LFMX 3.1-.20SNF2:6640	0.2	150	0.10	90	0.09	140	0.10	-	-	-	-	-	-	-	-
LFMX 3.1-.20SNF2:T8330	0.2	130	0.10	75	0.09	120	0.10	-	-	-	-	-	-	-	-
LFMX 4.1-.20SNF2:T8330	0.2	130	0.12	75	0.11	120	0.12	-	-	-	-	-	-	-	-
LFMX 5.1-.20SNF2:T8330	0.2	130	0.12	75	0.11	120	0.12	-	-	-	-	-	-	-	-
LFMX 6.35-.20SNF2:T8330	0.2	130	0.15	75	0.14	120	0.15	-	-	-	-	-	-	-	-

Suitability and starting values for cutting speed (vc) and feed (f). Refer to our Machining Calculator app for further calculations.

Product	RE (mm)	P		M		K		N		S		H		PSIRR (°)	PSIRL (°)
		vc (m/min)	f (mm/rev)	vc (m/min)	f (mm/rev)	vc (m/min)	f (mm/rev)	vc (m/min)	f (mm/rev)	vc (m/min)	f (mm/rev)	vc (m/min)	f (mm/rev)		

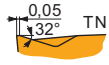
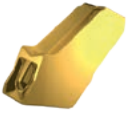

TN-F2 geometry for parting-off and grooving, and continuous cuts.

LFMX 3.1-.20TNF2:6640	● 0.2	■ 150	■ 0.10	■ 90	■ 0.09	■ 140	■ 0.10	—	—	—	—	—	—	—	—
LFMX 3.1-.20TNF2:T8330	● 0.2	■ 130	■ 0.10	■ 75	■ 0.09	■ 120	■ 0.10	—	—	—	—	—	—	—	—
LFMX 4.1-.20TNF2:T8330	● 0.2	■ 130	■ 0.12	■ 75	■ 0.11	■ 120	■ 0.12	—	—	—	—	—	—	—	—

LFMX - M2



	CW (mm)	CWTOLL (mm)	CWTOLU (mm)	BW (mm)
2.0	2.00	-0.03	0.03	1.60
2.2	2.20	-0.03	0.03	1.60
3.1	3.10	-0.04	0.04	2.60
4.1	4.10	-0.04	0.04	3.60
5.1	5.10	-0.04	0.04	4.60
6.35	6.35	-0.04	0.04	5.80

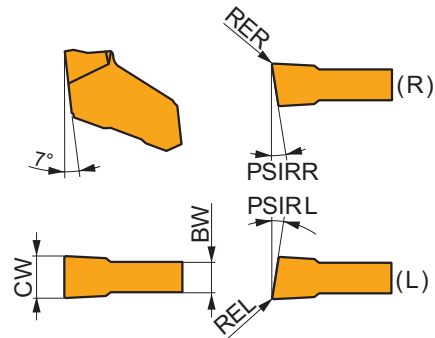

Suitability and starting values for cutting speed (vc) and feed (f). Refer to our Machining Calculator app for further calculations.

Product	RE (mm)	P		M		K		N		S		H		PSIRR (°)	PSIRL (°)
		vc (m/min)	f (mm/rev)	vc (m/min)	f (mm/rev)	vc (m/min)	f (mm/rev)	vc (m/min)	f (mm/rev)	vc (m/min)	f (mm/rev)	vc (m/min)	f (mm/rev)		

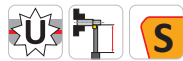

SN-M2 geometry for parting-off and grooving, and continuous to slightly interrupted cuts.

LFMX 2.0-.16SNM2:6640	● 0.2	■ 150	■ 0.11	■ 90	■ 0.10	■ 140	■ 0.11	—	—	—	—	—	—	—	—
LFMX 2.0-.16SNM2:T8330	● 0.2	■ 130	■ 0.11	■ 75	■ 0.10	■ 120	■ 0.11	—	—	—	—	—	—	—	—
LFMX 2.2-.16SNM2:6640	● 0.2	■ 150	■ 0.11	■ 90	■ 0.10	■ 140	■ 0.11	—	—	—	—	—	—	—	—
LFMX 2.2-.16SNM2:T8330	● 0.2	■ 130	■ 0.11	■ 75	■ 0.10	■ 120	■ 0.11	—	—	—	—	—	—	—	—
LFMX 3.1-.20SNM2:6640	● 0.2	■ 150	■ 0.15	■ 90	■ 0.14	■ 140	■ 0.15	—	—	—	—	—	—	—	—
LFMX 3.1-.20SNM2:T8330	● 0.2	■ 130	■ 0.15	■ 75	■ 0.14	■ 120	■ 0.15	—	—	—	—	—	—	—	—
LFMX 4.1-.20SNM2:6640	● 0.2	■ 150	■ 0.15	■ 90	■ 0.14	■ 140	■ 0.15	—	—	—	—	—	—	—	—
LFMX 4.1-.20SNM2:T8330	● 0.2	■ 130	■ 0.15	■ 75	■ 0.14	■ 120	■ 0.15	—	—	—	—	—	—	—	—
LFMX 5.1-.20SNM2:6640	● 0.2	■ 150	■ 0.20	■ 90	■ 0.18	■ 140	■ 0.20	—	—	—	—	—	—	—	—
LFMX 5.1-.20SNM2:T8330	● 0.2	■ 130	■ 0.20	■ 75	■ 0.18	■ 120	■ 0.20	—	—	—	—	—	—	—	—
LFMX 6.35-.20SNM2:6640	● 0.2	■ 150	■ 0.20	■ 90	■ 0.18	■ 140	■ 0.20	—	—	—	—	—	—	—	—
LFMX 6.35-.20SNM2:T8330	● 0.2	■ 130	■ 0.20	■ 75	■ 0.18	■ 120	■ 0.20	—	—	—	—	—	—	—	—

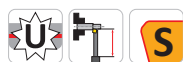
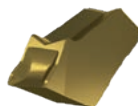

SR-M2 geometry, with right-handed design, for parting-off, and continuous to slightly interrupted cuts.

LFMX 2.0-.16SR12M2:T8330	● 0.2	■ 130	■ 0.09	■ 75	■ 0.08	■ 120	■ 0.09	—	—	—	—	—	—	12	—
LFMX 2.0-.16SR6M2:T8330	● 0.2	■ 130	■ 0.09	■ 75	■ 0.08	■ 120	■ 0.09	—	—	—	—	—	—	6	—
LFMX 3.1-.20SR8M2:T8330	● 0.2	■ 130	■ 0.11	■ 75	■ 0.10	■ 120	■ 0.11	—	—	—	—	—	—	8	—
LFMX 4.1-.20SR8M2:T8330	● 0.2	■ 130	■ 0.15	■ 75	■ 0.14	■ 120	■ 0.15	—	—	—	—	—	—	8	—

Suitability and starting values for cutting speed (vc) and feed (f). Refer to our Machining Calculator app for further calculations.

Product	RE (mm)	P		M		K		N		S		H		PSIRR (°)	PSIRL (°)
		vc (m/min)	f (mm/rev)	vc (m/min)	f (mm/rev)	vc (m/min)	f (mm/rev)	vc (m/min)	f (mm/rev)	vc (m/min)	f (mm/rev)	vc (m/min)	f (mm/rev)		

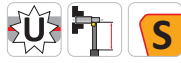
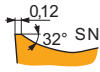
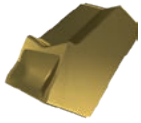

SL-M2 geometry, with left-handed design, for parting-off, and continuous to slightly interrupted cuts.

LFMX 2.0-.16SL12M2:T8330	● 0.2	■ 130	0.09	▣ 75	0.08	▤ 120	0.09	—	—	—	—	—	—	—	12
LFMX 2.0-.16SL6M2:T8330	● 0.2	■ 130	0.09	▣ 75	0.08	▤ 120	0.09	—	—	—	—	—	—	—	6
LFMX 3.1-.20SL8M2:T8330	● 0.2	■ 130	0.11	▣ 75	0.10	▤ 120	0.11	—	—	—	—	—	—	—	8
LFMX 4.1-.20SL8M2:T8330	● 0.2	■ 130	0.15	▣ 75	0.14	▤ 120	0.15	—	—	—	—	—	—	—	8

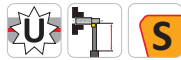
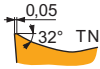

TN-M2 geometry for parting-off and grooving, and continuous to slightly interrupted cuts.

LFMX 3.1-.20TNM2:6640	● 0.2	■ 150	0.15	▣ 90	0.14	▤ 140	0.15	—	—	—	—	—	—	—	—
LFMX 3.1-.20TNM2:T8330	● 0.2	■ 130	0.15	▣ 75	0.14	▤ 120	0.15	—	—	—	—	—	—	—	—
LFMX 4.1-.20TNM2:6640	● 0.2	■ 150	0.15	▣ 90	0.14	▤ 140	0.15	—	—	—	—	—	—	—	—
LFMX 4.1-.20TNM2:T8330	● 0.2	■ 130	0.15	▣ 75	0.14	▤ 120	0.15	—	—	—	—	—	—	—	—

INTERNAL GROOVING TOOLS

INSERT SEAT	0313	0413	GL2	GL3	GL4
GG.(RL) INT DCON MS = 16 – 25 mm DMIN = 16 mm 					
GLAG (RL)INT DCON MS = 25 – 40 mm DMIN = 32 mm 			CDX 6 – 10 mm 	CDX 6 – 12 mm 	CDX 6 – 20 mm
Cutting width (mm) 	3	4	2	3	4
Grooving (internal) 					
Turning / Profiling (internal) 					

GLAG (RL) INT

P
M
K
N
S
H

PRAMET

G



Internal Grooving tool for GL inserts

Internal Right/Left handed tool holder with internal coolant for GL inserts, designed with reinforced seating and blade for security. Suited for internal grooving, turning and profiling applications. Body treated for longer tool life.

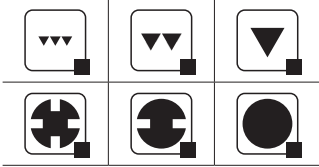
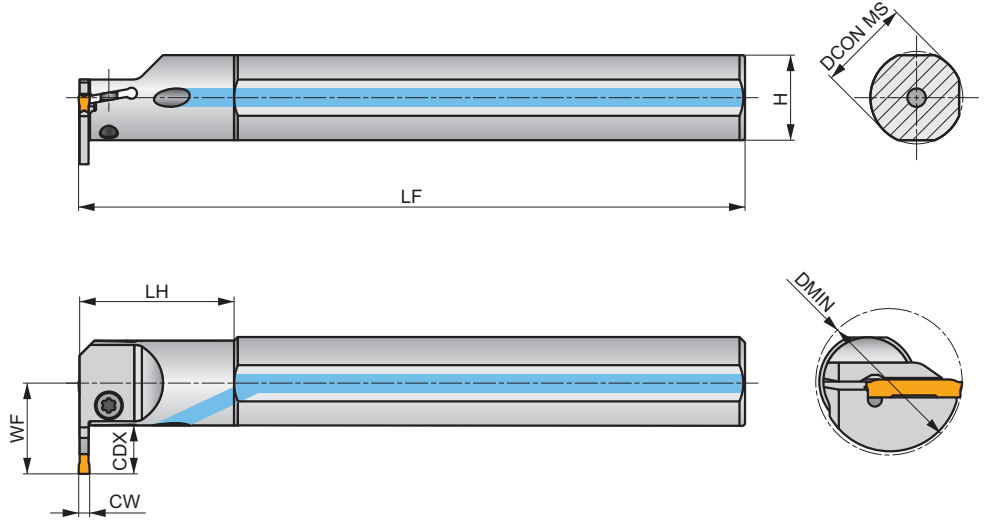
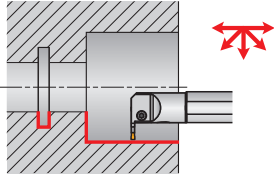

	Product	DCON MS (mm)	H (mm)	WF (mm)	LF (mm)	LH (mm)	CW (mm)	CDX (mm)	DMIN (mm)				
R	GL2-A25QGR-06-32	25	23	18.5	180	41.2	2.00	6	32	✓	0.57	GI360	GL14
	GL2-A25QGR-10-38	25	23	22.5	180	41.2	2.00	10	38	✓	0.57	GI360	GL14
	GL3-A25QGR-06-32	25	23	18.5	180	42.0	3.00	6	32	✓	0.57	GI361	GL14
	GL3-A25QGR-12-38	25	23	24.5	180	42.0	3.00	12	38	✓	0.58	GI361	GL14
	GL4-A25QGR-06-40	25	23	18.6	180	43.0	4.00	6	40	✓	0.58	GI362	GL14
	GL4-A25QGR-12-40	25	23	24.6	180	43.0	4.00	12	40	✓	0.58	GI362	GL14
	GL2-A32SGR-06-40	32	30	22	250	51.2	2.00	6	40	✓	1.38	GI360	GL14
	GL2-A32SGR-10-45	32	30	26	250	51.2	2.00	10	45	✓	1.30	GI360	GL14
	GL3-A32SGR-06-40	32	30	22	250	52.0	3.00	6	40	✓	1.38	GI361	GL14
	GL3-A32SGR-12-45	32	30	28	250	52.0	3.00	12	45	✓	1.30	GI361	GL14
	GL4-A32SGR-06-40	32	30	22.1	250	53.0	4.00	6	40	✓	1.39	GI362	GL14
	GL4-A32SGR-12-45	32	30	28.1	250	53.0	4.00	12	45	✓	1.39	GI362	GL14
	GL3-A40TGR-12-54	40	38	32	300	52.0	3.00	12	54	✓	2.69	GI361	GL14
	GL4-A40TGR-12-56	40	38	32.1	300	53.0	4.00	12	56	✓	2.60	GI362	GL14
GL4-A40TGR-20-62	40	38	40.1	300	53.0	4.00	20	62	✓	2.70	GI362	GL14	
L	GL2-A25QGL-06-32	25	23	18.5	180	41.2	2.00	6	32	✓	0.57	GI360	GL14
	GL2-A25QGL-10-38	25	23	22.5	180	41.2	2.00	10	38	✓	0.57	GI360	GL14
	GL3-A25QGL-06-32	25	23	18.5	180	42.0	3.00	6	32	✓	0.57	GI361	GL14
	GL3-A25QGL-12-38	25	23	24.5	180	42.0	3.00	12	38	✓	0.58	GI361	GL14
	GL4-A25QGL-06-40	25	23	18.6	180	43.0	4.00	6	40	✓	0.58	GI362	GL14
	GL4-A25QGL-12-40	25	23	24.6	180	43.0	4.00	12	40	✓	0.58	GI362	GL14
	GL2-A32SGL-06-40	32	30	22	250	51.2	2.00	6	40	✓	1.38	GI360	GL14
	GL2-A32SGL-10-45	32	30	26	250	51.2	2.00	10	45	✓	1.38	GI360	GL14
	GL3-A32SGL-06-40	32	30	22	250	52.0	3.00	6	40	✓	1.30	GI361	GL14
	GL3-A32SGL-12-45	32	30	28	250	52.0	3.00	12	45	✓	1.38	GI361	GL14
	GL4-A32SGL-06-40	32	30	22.1	250	53.0	4.00	6	40	✓	1.39	GI362	GL14
	GL4-A32SGL-12-45	32	30	28.1	250	53.0	4.00	12	45	✓	1.30	GI362	GL14

Product	D CON MS	H	WF	LF	LE	CW	CDX	DMIN				
	(mm)	(mm)	(mm)	(mm)	(mm)	(mm)	(mm)	(mm)				
L GL3-A40TGL-12-54	40	38	32	300	52.0	3.00	12	54	✓	2.60	GI361	GL14
GL4-A40TGL-12-56	40	38	32.1	300	53.0	4.00	12	56	✓	2.70	GI362	GL14
GL4-A40TGL-20-62	40	38	40.1	300	53.0	4.00	20	62	✓	2.70	GI362	GL14

¹⁾ Geometry MM is applicable only when DMIN >= 68 mm.

GI360	GL2-GM	GL2-MM
GI361	GL3-GM	GL3-MM
GI362	GL4-GM	GL4-MM

GL14	US 5015-T20P	5.0	M 5	15	LKT20P

GL. D - GM



	CW (mm)	CWTOLL (mm)	CWTOLU (mm)	INSL (mm)
200	2.00	-0.05	0.05	25.0
300	3.00	-0.05	0.05	25.0
400	4.00	-0.05	0.05	25.0
500	5.00	-0.05	0.05	25.0
600	6.00	-0.05	0.05	25.0
800	8.00	-0.05	0.05	25.0

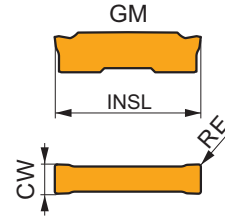

Suitability and starting values for cutting speed (vc), feed (f) and depth of cut (ap). Refer to our Machining Calculator app for further calculations.

Product	RE (mm)	P			M			K			N			S			H		
		vc (m/min)	f (mm/rev)	ap (mm)	vc (m/min)	f (mm/rev)	ap (mm)	vc (m/min)	f (mm/rev)	ap (mm)	vc (m/min)	f (mm/rev)	ap (mm)	vc (m/min)	f (mm/rev)	ap (mm)	vc (m/min)	f (mm/rev)	ap (mm)



GM versatile geometry for grooving and longitudinal turning, and continuous to interrupted cuts.

GL2-D200M02-GM:G8330	0.2	190	0.10	0.8	110	0.09	0.8	180	0.10	0.8	-	-	-	45	0.08	0.6	-	-	-
GL2-D200M02-GM:T7325	0.2	220	0.10	0.8	170	0.09	0.8	205	0.10	0.8	-	-	-	70	0.08	0.6	-	-	-
GL3-D300M02-GM:G8330	0.2	150	0.20	1.0	90	0.18	1.0	140	0.20	1.0	-	-	-	35	0.14	0.8	-	-	-
GL3-D300M02-GM:T7325	0.2	175	0.20	1.0	135	0.18	1.0	165	0.20	1.0	-	-	-	55	0.14	0.8	-	-	-
GL3-D300M04-GM:G8330	0.4	160	0.20	1.0	95	0.18	1.0	150	0.20	1.0	-	-	-	40	0.14	0.8	-	-	-
GL3-D300M04-GM:T7325	0.4	185	0.20	1.0	140	0.18	1.0	175	0.20	1.0	-	-	-	60	0.14	0.8	-	-	-
GL4-D400M04-GM:G8330	0.4	150	0.25	1.2	90	0.23	1.2	140	0.25	1.2	-	-	-	35	0.18	1.0	-	-	-
GL4-D400M04-GM:T7325	0.4	170	0.25	1.2	130	0.23	1.2	160	0.25	1.2	-	-	-	55	0.18	1.0	-	-	-
GL4-D400M08-GM:G8330	0.8	180	0.25	1.2	105	0.23	1.2	170	0.25	1.2	-	-	-	45	0.18	1.0	-	-	-
GL4-D400M08-GM:T7325	0.8	200	0.25	1.2	155	0.23	1.2	190	0.25	1.2	-	-	-	65	0.18	1.0	-	-	-
GL5-D500M08-GM:G8330	0.8	170	0.30	1.2	100	0.27	1.2	160	0.30	1.2	-	-	-	40	0.21	1.0	-	-	-
GL5-D500M08-GM:T7325	0.8	190	0.30	1.2	145	0.27	1.2	180	0.30	1.2	-	-	-	60	0.21	1.0	-	-	-
GL6-D600M08-GM:G8330	0.8	170	0.30	1.2	100	0.27	1.2	160	0.30	1.2	-	-	-	40	0.21	1.0	-	-	-
GL6-D600M08-GM:T7325	0.8	190	0.30	1.2	145	0.27	1.2	180	0.30	1.2	-	-	-	60	0.21	1.0	-	-	-
GL6-D800M08-GM:G8330 ¹⁾	0.8	170	0.30	1.2	100	0.27	1.2	160	0.30	1.2	-	-	-	40	0.21	1.2	-	-	-

¹⁾ Usable only in holders with CDX ≥ 24.

GL. D - MM



	CW (mm)	CWTOLL (mm)	CWTOLU (mm)	INSL (mm)
200	2.00	-0.05	0.05	25.0
300	3.00	-0.05	0.05	25.0
400	4.00	-0.05	0.05	25.0
500	5.00	-0.05	0.05	26.0
600	6.00	-0.05	0.05	26.0

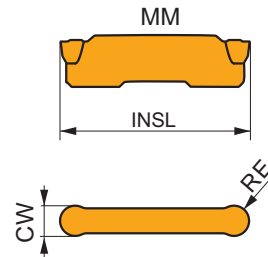

Suitability and starting values for cutting speed (vc), feed (f) and depth of cut (ap). Refer to our Machining Calculator app for further calculations.

Product	RE (mm)	P			M			K			N			S			H		
		vc (m/min)	f (mm/rev)	ap (mm)	vc (m/min)	f (mm/rev)	ap (mm)	vc (m/min)	f (mm/rev)	ap (mm)	vc (m/min)	f (mm/rev)	ap (mm)	vc (m/min)	f (mm/rev)	ap (mm)	vc (m/min)	f (mm/rev)	ap (mm)



MM geometry, with full radius shape for copy profiling and longitudinal turning, and continuous to interrupted cuts.

GL2-D200MMO-MM:G8330	1.0	250	0.10	1.0	150	0.09	1.0	235	0.10	1.0	-	-	-	60	0.08	0.8	-	-	-
GL2-D200MMO-MM:T7325	1.0	285	0.10	1.0	220	0.09	1.0	270	0.10	1.0	-	-	-	90	0.08	0.8	-	-	-
GL3-D300MMO-MM:G8330	1.5	210	0.20	1.2	125	0.18	1.2	195	0.20	1.2	-	-	-	50	0.14	1.0	-	-	-
GL3-D300MMO-MM:T7325	1.5	240	0.20	1.2	185	0.18	1.2	225	0.20	1.2	-	-	-	75	0.14	1.0	-	-	-
GL4-D400MMO-MM:G8330	2.0	220	0.20	1.2	130	0.18	1.2	205	0.20	1.2	-	-	-	55	0.14	1.0	-	-	-
GL4-D400MMO-MM:T7325	2.0	250	0.20	1.2	195	0.18	1.2	235	0.20	1.2	-	-	-	80	0.14	1.0	-	-	-
GL5-D500MMO-MM:G8330	2.5	205	0.25	1.2	120	0.23	1.2	190	0.25	1.2	-	-	-	50	0.18	1.0	-	-	-
GL5-D500MMO-MM:T7325	2.5	235	0.25	1.2	180	0.23	1.2	220	0.25	1.2	-	-	-	75	0.18	1.0	-	-	-
GL6-D600MMO-MM:G8330	3.0	195	0.30	1.2	115	0.27	1.2	185	0.30	1.2	-	-	-	45	0.21	1.0	-	-	-
GL6-D600MMO-MM:T7325	3.0	220	0.30	1.2	170	0.27	1.2	205	0.30	1.2	-	-	-	70	0.21	1.0	-	-	-

GG.(RL) INT



PRAMET

G



Internal Grooving Boring Bar for LCM. Inserts

Internal Right/Left hand grooving boring bar for grooving with LCM. inserts. Suited for internal grooving and multi-directional turning. Body treated for longer tool life.

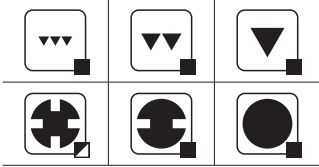
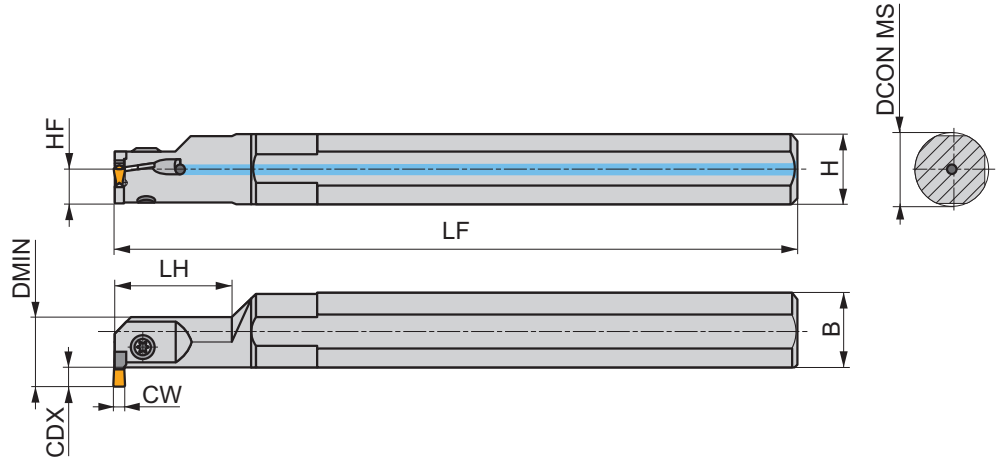
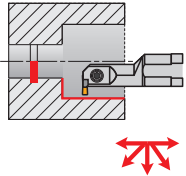

Product	DCON MS (mm)	HF (mm)	H (mm)	B (mm)	LF (mm)	LH (mm)	CW (mm)	CDX (mm)	DMIN (mm)					
R	A16Q-GGER 0313	16	7.5	15	15.5	180	25.0	3.00	3	16	✓	0.26	GI143	GL06
	A20R-GGFR 0313	20	9	18	19	200	30.0	3.00	4.5	20	✓	0.38	GI143	GL06
	A25S-GGHR 0313	25	11.5	23	24	250	40.0	3.00	6.5	25	✓	0.78	GI143	GL06
	A25S-GGFR 0413	25	11.5	23	24	250	40.0	4.00	6.5	25	✓	0.78	GI170	GL06
L	A16Q-GGEL 0313	16	7.5	15	15.5	180	25.0	3.00	3	16	✓	0.27	GI143	GL06
	A20R-GGFL 0313	20	9	18	19	200	30.0	3.00	4.5	20	✓	0.38	GI143	GL06
	A25S-GGHL 0313	25	11.5	23	24	250	40.0	3.00	6.5	25	✓	0.78	GI143	GL06



GI143
GI170

LCM. 0313..
LCM. 0413..



GL06

SR 85011-T15P

5.0

M 5

9

FLAGT15P

LCMF 13 - CM



	CW (mm)	CWTOLL (mm)	CWTOLU (mm)	INSL (mm)
0313	3.00	-0.05	0.05	12.6
0413	4.00	-0.05	0.05	12.6

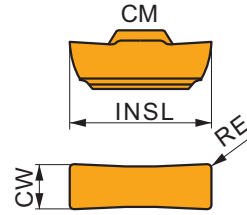

Suitability and starting values for cutting speed (vc) and feed (f). Refer to our Machining Calculator app for further calculations.

Product	RE (mm)	P		M		K		N		S		H		PSIRR (°)	PSIRL (°)
		vc (m/min)	f (mm/rev)	vc (m/min)	f (mm/rev)	vc (m/min)	f (mm/rev)	vc (m/min)	f (mm/rev)	vc (m/min)	f (mm/rev)				



CM geometry and first choice for grooving.

LCMF 031304-CM:T8330	0.4	130	0.11	75	0.10	120	0.11	-	-	-	-	-	-	-	-
LCMF 041304-CM:T8330	0.4	130	0.11	75	0.10	120	0.11	-	-	-	-	-	-	-	-

LCMF 13 - F



	CW (mm)	CWTOLL (mm)	CWTOLU (mm)	INSL (mm)
0313	3.00	-0.05	0.05	12.6
0413	4.00	-0.05	0.05	12.6

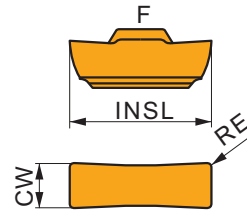

Suitability and starting values for cutting speed (vc), feed (f) and depth of cut (ap). Refer to our Machining Calculator app for further calculations.

Product	RE (mm)	P			M			K			N			S			H		
		vc (m/min)	f (mm/rev)	ap (mm)	vc (m/min)	f (mm/rev)	ap (mm)	vc (m/min)	f (mm/rev)	ap (mm)	vc (m/min)	f (mm/rev)	ap (mm)	vc (m/min)	f (mm/rev)	ap (mm)	vc (m/min)	f (mm/rev)	ap (mm)

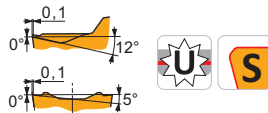

F geometry and first choice for turning.

LCMF 031302-F:T8330	0.2	195	0.10	0.3	115	0.09	0.3	185	0.10	0.3	-	-	-	-	-	-	-	-	-
LCMF 031304-F:T8330	0.4	185	0.13	0.5	110	0.12	0.5	175	0.13	0.5	-	-	-	-	-	-	-	-	-
LCMF 041304-F:T8330	0.4	185	0.13	0.5	110	0.12	0.5	175	0.13	0.5	-	-	-	-	-	-	-	-	-

LCMF 13 - MP



	CW (mm)	CWTOLL (mm)	CWTOLU (mm)	INSL (mm)
0313	3.00	-0.05	0.05	12.6
0413	4.00	-0.05	0.05	12.6

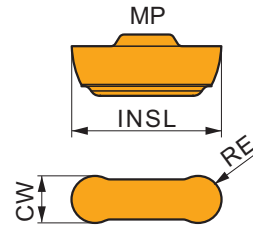

Suitability and starting values for cutting speed (vc), feed (f) and depth of cut (ap). Refer to our Machining Calculator app for further calculations.

Product	RE (mm)	P			M			K			N			S			H		
		vc (m/min)	f (mm/rev)	ap (mm)	vc (m/min)	f (mm/rev)	ap (mm)	vc (m/min)	f (mm/rev)	ap (mm)	vc (m/min)	f (mm/rev)	ap (mm)	vc (m/min)	f (mm/rev)	ap (mm)	vc (m/min)	f (mm/rev)	ap (mm)

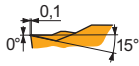

MP geometry for longitudinal turning and copy profiling, fine and finish machining, and continuous to interrupted cuts.

LCMF 0313MO-MP:T8330		1.5	190	0.30	0.8	110	0.27	0.8	180	0.30	0.8	-	-	-	-	-	-	-
LCMF 0413MO-MP:T8330		2.0	175	0.40	1.0	105	0.36	1.0	165	0.40	1.0	-	-	-	-	-	-	-

O-RING AND CIRCLIPS GROOVING

	EXTERNAL		INTERNAL			
P61(RL) EXT 16x16 20x20 25x25						
P61(RL) INT DCON MS = 12 – 32 mm DMIN = 16 – 40 mm						
P615(RL)-1 INT DCON MS = 10 – 12 mm DMIN = 12.5 mm						
Grooving for circlips 	 X61 CW = 0,85 – 3,2	 X61 CW = 0,85 – 3,2	 X61 CW = 0,85 – 3,2	 X61 CW = 0,85 – 3,2	 X61-1 CW = 0,85 – 2,2	 X61-1 CW = 0,85 – 2,2
Grooving for o-rings 	 X61 R RE = 1 – 1.5	 X61 R RE = 1 – 1.5	 X61 R RE = 1 – 1.5	 X61 R RE = 1 – 1.5	 X61 R-1 RE = 0.5 – 1	 X61 R-1 RE = 0.5 – 1

P61(RL) EXT



PRAMET

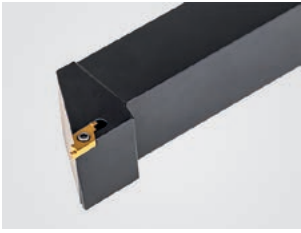

External Grooving Tool Holder for X61 Circlips and O-Ring Inserts

External Right/Left hand radial tool holder for grooving with X61 double-sided circlip or O-ring inserts. Gives smooth cutting action for high tolerated dimensions. Body treated for longer tool life.

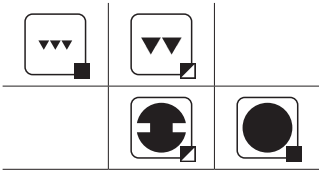
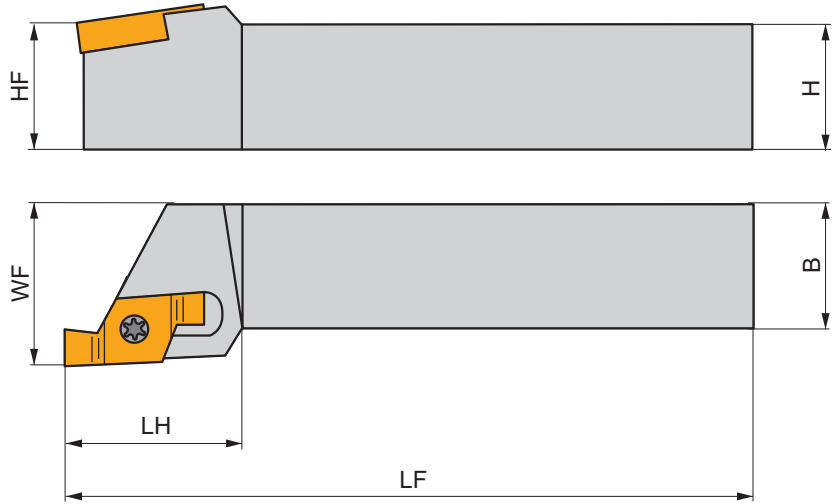
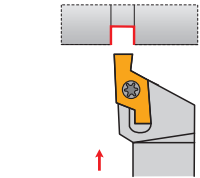

Product	⌀	H	B	WF	LF	HF	kg		
	(mm)	(mm)	(mm)	(mm)	(mm)	(mm)			
R P61.SFR-1616H-06	16	16	16	20	100	21.0	0.23	GI332_1	SV11
P61.SFR-2020K-06	20	20	20	25	125	25.0	0.40	GI332_1	SV11
P61.SFR-2525M-06	25	25	25	32	150	32.0	0.72	GI332_1	SV11
L P61.SFL-1616H-06	16	16	16	20	100	21.0	0.22	GI332_2	SV11
P61.SFL-2020K-06	20	20	20	25	125	25.0	0.41	GI332_2	SV11
P61.SFL-2525M-06	25	25	25	32	150	32.0	0.73	GI332_2	SV11

GI332_1
 X61 0602.. R

SV11
 US 2003-T07P
 0.8 Nm
 M 2.5
 6.5
 FLAG T07P

P61(RL) INT



PRAMET



Internal Circlip Grooving Boring bar for X61 Inserts

Internal Right/Left hand grooving boring bar for grooving with X61 double-sided inserts. Suited for internal cutting of circlip or O-ring grooves. Body treated for longer tool life.

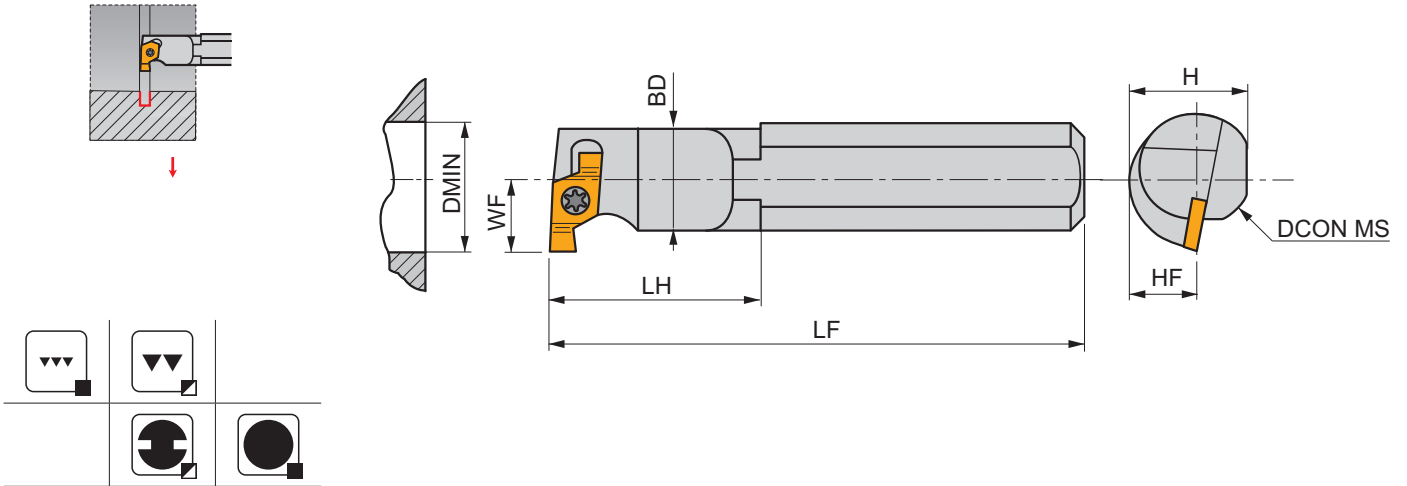

Product	DCON MS	DMIN	BD	WF	H	LF	LH	KAPR				
	(mm)	(mm)	(mm)	(mm)	(mm)	(mm)	(°)					
R	P61.SGR-0012M-06	12	16	11.5	9	150	22.0	0	-	0.16	GI332_2	SV11
	P61.SGR-A-0016M-06	16	20	15	11	150	29.0	0	✓	0.23	GI332_2	SV11
	P61.SGR-A-0020P-06	20	25	19	13	170	29.0	0	✓	0.38	GI332_2	SV11
	P61.SGR-A-0025R-06	25	32	24	17	200	31.0	0	✓	0.70	GI332_2	SV11
	P61.SGR-A-0032T-06	32	40	31	22	300	49.0	0	✓	1.72	GI332_2	SV11
L	P61.SGL-0012M-06	12	16	11.5	9	150	22.0	0	-	0.16	GI332_1	SV11
	P61.SGL-A-0016M-06	16	20	15	11	150	29.0	0	✓	0.23	GI332_1	SV11
	P61.SGL-A-0020P-06	20	25	19	13	170	29.0	0	✓	0.39	GI332_1	SV11
	P61.SGL-A-0025R-06	25	32	24	17	200	31.0	0	✓	0.71	GI332_1	SV11
	P61.SGL-A-0032T-06	32	40	31	22	300	49.0	0	✓	1.72	GI332_1	SV11

SV11	US 2003-T07P	0.8	M 2.5	6.5	FLAG T07P

Left hand insert mount to right hand boring bar.

X 61



	W1	CWTOLL	CWTOLU	S
	(mm)	(mm)	(mm)	(mm)
0602	6.350	-0.03	0.03	2.33

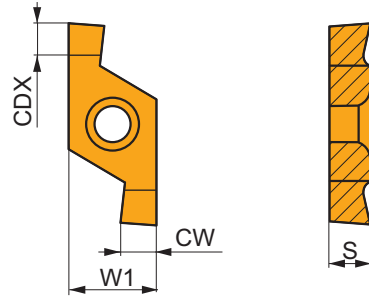

Suitability and starting values for cutting speed (vc) and feed (f). Refer to our Machining Calculator app for further calculations.

Product	RE (mm)	P		M		K		N		S		H		CW (mm)	CDX (mm)
		vc (m/min)	f (mm/rev)	vc (m/min)	f (mm/rev)	vc (m/min)	f (mm/rev)	vc (m/min)	f (mm/rev)	vc (m/min)	f (mm/rev)	vc (m/min)	f (mm/rev)		

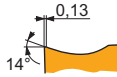

X61-R external and internal, right-handed geometry, for o-ring and circlip groove machining, with continuous cuts.

X61 0602-080 R:6640	●	–	■	195	0.06	■	115	0.05	■	185	0.06	–	–	–	–	0.85	0.8
X61 0602-080 R:G8330	●	–	■	145	0.06	■	85	0.05	■	135	0.06	–	–	–	–	0.85	0.8
X61 0602-090 R:6640	●	–	■	195	0.06	■	115	0.05	■	185	0.06	–	–	–	–	0.95	0.8
X61 0602-090 R:G8330	●	–	■	145	0.06	■	85	0.05	■	135	0.06	–	–	–	–	0.95	0.8
X61 0602-100 R:6640	●	–	■	195	0.06	■	115	0.05	■	185	0.06	–	–	–	–	1.05	0.8
X61 0602-100 R:G8330	●	–	■	145	0.06	■	85	0.05	■	135	0.06	–	–	–	–	1.05	0.8
X61 0602-110 R:6640	●	–	■	185	0.06	■	110	0.05	■	175	0.06	–	–	–	–	1.15	1.2
X61 0602-110 R:G8330	●	–	■	140	0.06	■	80	0.05	■	130	0.06	–	–	–	–	1.15	1.2
X61 0602-130 R:6640	●	–	■	185	0.06	■	110	0.05	■	175	0.06	–	–	–	–	1.35	1.4
X61 0602-130 R:G8330	●	–	■	140	0.06	■	80	0.05	■	130	0.06	–	–	–	–	1.35	1.4
X61 0602-150 R:6640	●	–	■	180	0.06	■	105	0.05	■	170	0.06	–	–	–	–	1.55	1.6
X61 0602-150 R:G8330	●	–	■	135	0.06	■	80	0.05	■	125	0.06	–	–	–	–	1.55	1.6
X61 0602-160 R:6640	●	–	■	180	0.06	■	105	0.05	■	170	0.06	–	–	–	–	1.65	1.7
X61 0602-160 R:G8330	●	–	■	135	0.06	■	80	0.05	■	125	0.06	–	–	–	–	1.65	1.7
X61 0602-185 R:6640	●	–	■	150	0.09	■	90	0.08	■	140	0.09	–	–	–	–	1.90	2
X61 0602-185 R:G8330	●	–	■	120	0.09	■	70	0.08	■	110	0.09	–	–	–	–	1.90	2
X61 0602-200 R:G8330	●	–	■	115	0.09	■	65	0.08	■	105	0.09	–	–	–	–	2.05	2.2
X61 0602-215 R:6640	●	–	■	145	0.09	■	85	0.08	■	135	0.09	–	–	–	–	2.20	2.4
X61 0602-215 R:G8330	●	–	■	115	0.09	■	65	0.08	■	105	0.09	–	–	–	–	2.20	2.4
X61 0602-250 R:G8330	●	–	■	115	0.09	■	65	0.08	■	105	0.09	–	–	–	–	2.55	2.6
X61 0602-265 R:6640	●	–	■	125	0.12	■	75	0.11	■	115	0.12	–	–	–	–	2.70	2.7
X61 0602-265 R:G8330	●	–	■	105	0.12	■	60	0.11	■	95	0.12	–	–	–	–	2.70	2.7
X61 0602-300 R:6640	●	–	■	125	0.12	■	75	0.11	■	115	0.12	–	–	–	–	3.05	3
X61 0602-300 R:G8330	●	–	■	105	0.12	■	60	0.11	■	95	0.12	–	–	–	–	3.05	3
X61 0602-315 R:6640	●	–	■	125	0.12	■	75	0.11	■	115	0.12	–	–	–	–	3.20	3
X61 0602-315 R:G8330	●	–	■	105	0.12	■	60	0.11	■	95	0.12	–	–	–	–	3.20	3

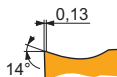

X61-L external and internal, left-handed geometry, for o-ring and circlip groove machining, with continuous cuts.

X61 0602-080 L:6640	●	–	■	195	0.06	■	115	0.05	■	185	0.06	–	–	–	–	0.85	0.8
X61 0602-080 L:G8330	●	–	■	145	0.06	■	85	0.05	■	135	0.06	–	–	–	–	0.85	0.8
X61 0602-090 L:6640	●	–	■	195	0.06	■	115	0.05	■	185	0.06	–	–	–	–	0.95	0.8
X61 0602-090 L:G8330	●	–	■	145	0.06	■	85	0.05	■	135	0.06	–	–	–	–	0.95	0.8
X61 0602-100 L:6640	●	–	■	195	0.06	■	115	0.05	■	185	0.06	–	–	–	–	1.05	0.8
X61 0602-100 L:G8330	●	–	■	145	0.06	■	85	0.05	■	135	0.06	–	–	–	–	1.05	0.8
X61 0602-110 L:6640	●	–	■	185	0.06	■	110	0.05	■	175	0.06	–	–	–	–	1.15	1.2
X61 0602-110 L:G8330	●	–	■	140	0.06	■	80	0.05	■	130	0.06	–	–	–	–	1.15	1.2
X61 0602-130 L:6640	●	–	■	185	0.06	■	110	0.05	■	175	0.06	–	–	–	–	1.35	1.4
X61 0602-130 L:G8330	●	–	■	140	0.06	■	80	0.05	■	130	0.06	–	–	–	–	1.35	1.4

Suitability and starting values for cutting speed (vc) and feed (f). Refer to our Machining Calculator app for further calculations.

Product	RE (mm)	P		M		K		N		S		H		CW (mm)	CDX (mm)
		vc (m/min)	f (mm/rev)	vc (m/min)	f (mm/rev)	vc (m/min)	f (mm/rev)	vc (m/min)	f (mm/rev)	vc (m/min)	f (mm/rev)	vc (m/min)	f (mm/rev)		

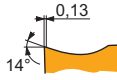

X61-L external and internal, left-handed geometry, for o-ring and circlip groove machining, with continuous cuts.

X61 0602-150 L:6640	●	–	■	180	0.06	■	105	0.05	■	170	0.06	–	–	–	–	1.55	1.6
X61 0602-150 L:G8330	●	–	■	135	0.06	■	80	0.05	■	125	0.06	–	–	–	–	1.55	1.6
X61 0602-160 L:6640	●	–	■	180	0.06	■	105	0.05	■	170	0.06	–	–	–	–	1.65	1.7
X61 0602-160 L:G8330	●	–	■	135	0.06	■	80	0.05	■	125	0.06	–	–	–	–	1.65	1.7
X61 0602-185 L:6640	●	–	■	150	0.09	■	90	0.08	■	140	0.09	–	–	–	–	1.90	2
X61 0602-185 L:G8330	●	–	■	120	0.09	■	70	0.08	■	110	0.09	–	–	–	–	1.90	2
X61 0602-200 L:G8330	●	–	■	115	0.09	■	65	0.08	■	105	0.09	–	–	–	–	2.05	2.2
X61 0602-215 L:6640	●	–	■	145	0.09	■	85	0.08	■	135	0.09	–	–	–	–	2.20	2.4
X61 0602-215 L:G8330	●	–	■	115	0.09	■	65	0.08	■	105	0.09	–	–	–	–	2.20	2.4
X61 0602-250 L:G8330	●	–	■	115	0.09	■	65	0.08	■	105	0.09	–	–	–	–	2.55	2.6
X61 0602-265 L:6640	●	–	■	125	0.12	■	75	0.11	■	115	0.12	–	–	–	–	2.70	2.7
X61 0602-265 L:G8330	●	–	■	105	0.12	■	60	0.11	■	95	0.12	–	–	–	–	2.70	2.7
X61 0602-300 L:6640	●	–	■	125	0.12	■	75	0.11	■	115	0.12	–	–	–	–	3.05	3
X61 0602-300 L:G8330	●	–	■	105	0.12	■	60	0.11	■	95	0.12	–	–	–	–	3.05	3
X61 0602-315 L:6640	●	–	■	125	0.12	■	75	0.11	■	115	0.12	–	–	–	–	3.20	3
X61 0602-315 L:G8330	●	–	■	105	0.12	■	60	0.11	■	95	0.12	–	–	–	–	3.20	3

X 61 R



	W1 (mm)	CWTOLL (mm)	CWTOLU (mm)	S (mm)
0602	6.350	-0.03	0.03	2.33

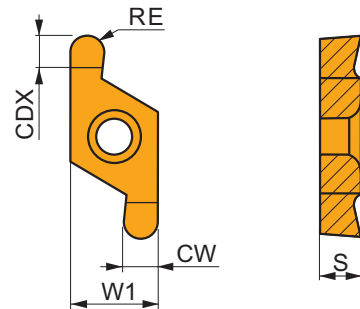

Suitability and starting values for cutting speed (vc) and feed (f). Refer to our Machining Calculator app for further calculations.

Product	RE (mm)	P		M		K		N		S		H		CW (mm)	CDX (mm)
		vc (m/min)	f (mm/rev)	vc (m/min)	f (mm/rev)	vc (m/min)	f (mm/rev)	vc (m/min)	f (mm/rev)	vc (m/min)	f (mm/rev)	vc (m/min)	f (mm/rev)		



X61R-R external and internal, right-handed geometry, for o-ring and circlip groove machining, with continuous cuts.

X61 0602-R100 R:6640	●	1.0	■	170	0.06	■	100	0.05	■	160	0.06	–	–	–	–	2.09	3
X61 0602-R100 R:G8330	●	1.0	■	130	0.06	■	75	0.05	■	120	0.06	–	–	–	–	2.09	3
X61 0602-R150 R:6640	●	1.5	■	175	0.06	■	105	0.05	■	165	0.06	–	–	–	–	3.09	3
X61 0602-R150 R:G8330	●	1.5	■	135	0.06	■	80	0.05	■	125	0.06	–	–	–	–	3.09	3



X61R-L external and internal, left-handed geometry, for o-ring and circlip groove machining, with continuous cuts.

X61 0602-R100 L:6640	●	1.0	■	170	0.06	■	100	0.05	■	160	0.06	–	–	–	–	2.09	3
X61 0602-R100 L:G8330	●	1.0	■	130	0.06	■	75	0.05	■	120	0.06	–	–	–	–	2.09	3
X61 0602-R150 L:6640	●	1.5	■	175	0.06	■	105	0.05	■	165	0.06	–	–	–	–	3.09	3
X61 0602-R150 L:G8330	●	1.5	■	135	0.06	■	80	0.05	■	125	0.06	–	–	–	–	3.09	3

P61S(RL)-1 INT



PRAMET



Internal Circlip Grooving Boring Bar for X61-1 Inserts

Internal Right/Left hand grooving boring bar for grooving with single-sided X61-1 inserts. Suited for internal cutting of circlip or O-ring grooves. Body treated for longer tool life.

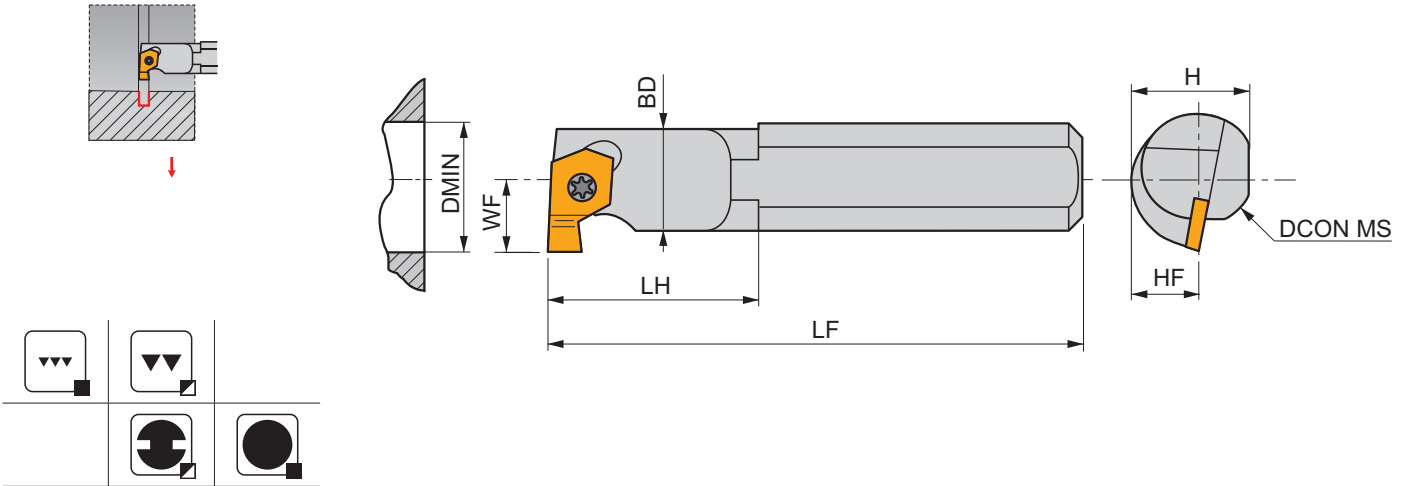

Product	DCON MS	DMIN	BD	WF	H	LF	LH	KAPR	kg	GI333	SV11
	(mm)	(mm)	(mm)	(mm)	(mm)	(mm)	(mm)	(°)			
R P61.SGR-0010M-06/1	10	12.5	10	7.5	9	150	19.0	0	0.12	GI333_2	SV11
P61.SGR-0012M-06/1	12	12.5	10	7.5	11	150	19.0	0	0.16	GI333_2	SV11
L P61.SGL-0010M-06/1	10	12.5	10	7.5	9	150	19.0	0	0.12	GI333_1	SV11
P61.SGL-0012M-06/1	12	12.5	10	7.5	11	150	19.0	0	0.16	GI333_1	SV11

GI333_1	X61 0602..-1 R
---------	----------------

SV11	US 2003-T07P	0.8	M 2.5	6.5	FLAG T07P
------	--------------	-----	-------	-----	-----------

Left hand insert mount to right hand boring bar.

X 61-1



	W1 (mm)	CWTOLL (mm)	CWTOLU (mm)	S (mm)
0602	6.350	-0.03	0.03	2.33

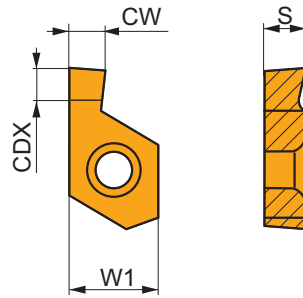

Suitability and starting values for cutting speed (vc) and feed (f). Refer to our Machining Calculator app for further calculations.

Product	RE (mm)	P		M		K		N		S		H		CW (mm)	CDX (mm)
		vc (m/min)	f (mm/rev)	vc (m/min)	f (mm/rev)	vc (m/min)	f (mm/rev)	vc (m/min)	f (mm/rev)	vc (m/min)	f (mm/rev)	vc (m/min)	f (mm/rev)		

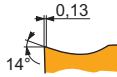

X61-1-R internal, right-handed design, with one cutting edge for o-ring and circlip groove machining, with continuous cuts.

X61 0602-080 R1:6640	●	–	■	195 0.06	▣	115 0.05	▤	185 0.06	–	–	–	–	–	0.85	0.8
X61 0602-090 R1:6640	●	–	■	195 0.06	▣	115 0.05	▤	185 0.06	–	–	–	–	–	0.95	0.8
X61 0602-110 R1:6640	●	–	■	185 0.06	▣	110 0.05	▤	175 0.06	–	–	–	–	–	1.15	1.2
X61 0602-130 R1:6640	●	–	■	185 0.06	▣	110 0.05	▤	175 0.06	–	–	–	–	–	1.35	1.4
X61 0602-160 R1:6640	●	–	■	180 0.06	▣	105 0.05	▤	170 0.06	–	–	–	–	–	1.65	1.7
X61 0602-185 R1:6640	●	–	■	150 0.09	▣	90 0.08	▤	140 0.09	–	–	–	–	–	1.90	2
X61 0602-215 R1:6640	●	–	■	145 0.09	▣	85 0.08	▤	135 0.09	–	–	–	–	–	2.20	2.2

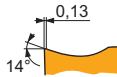

X61-1-L internal, left-handed design, with one cutting edge for o-ring and circlip groove machining, with continuous cuts.

X61 0602-080 L1:6640	●	–	■	195 0.06	▣	115 0.05	▤	185 0.06	–	–	–	–	–	0.85	0.8
X61 0602-090 L1:6640	●	–	■	195 0.06	▣	115 0.05	▤	185 0.06	–	–	–	–	–	0.95	0.8
X61 0602-110 L1:6640	●	–	■	185 0.06	▣	110 0.05	▤	175 0.06	–	–	–	–	–	1.15	1.2
X61 0602-130 L1:6640	●	–	■	185 0.06	▣	110 0.05	▤	175 0.06	–	–	–	–	–	1.35	1.4
X61 0602-160 L1:6640	●	–	■	180 0.06	▣	105 0.05	▤	170 0.06	–	–	–	–	–	1.65	1.7
X61 0602-185 L1:6640	●	–	■	150 0.09	▣	90 0.08	▤	140 0.09	–	–	–	–	–	1.90	2
X61 0602-215 L1:6640	●	–	■	145 0.09	▣	85 0.08	▤	135 0.09	–	–	–	–	–	2.20	2.2

X 61 R-1



	W1	CWTOLL	CWTOLU	S
	(mm)	(mm)	(mm)	(mm)
0602	6.350	-0.03	0.03	2.33

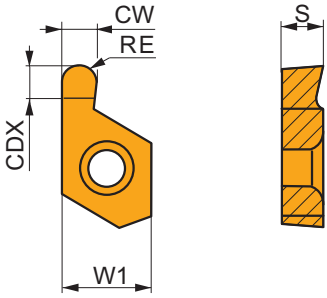

Suitability and starting values for cutting speed (vc) and feed (f). Refer to our Machining Calculator app for further calculations.

Product	RE (mm)	P		M		K		N		S		H		CW (mm)	CDX (mm)
		vc (m/min)	f (mm/rev)	vc (m/min)	f (mm/rev)	vc (m/min)	f (mm/rev)	vc (m/min)	f (mm/rev)	vc (m/min)	f (mm/rev)	vc (m/min)	f (mm/rev)		



X 61 R-1-R internal, right-handed design, with one cutting edge for o-ring and circlip groove machining, with continuous cuts.

X61 0602-R050 R1:6640	● 0.5	■ 145	■ 0.06	■ 85	■ 0.05	■ 135	■ 0.06	■ -	■ -	■ -	■ -	■ -	■ -	1.09	1.3
X61 0602-R100 R1:6640	● 1.0	■ 170	■ 0.06	■ 100	■ 0.05	■ 160	■ 0.06	■ -	■ -	■ -	■ -	■ -	■ -	2.09	2.8



X 61 R-1-L internal, left-handed design, with one cutting edge for o-ring and circlip groove machining, with continuous cuts.

X61 0602-R050 L1:6640	● 0.5	■ 145	■ 0.06	■ 85	■ 0.05	■ 135	■ 0.06	■ -	■ -	■ -	■ -	■ -	■ -	1.09	1.3
X61 0602-R100 L1:6640	● 1.0	■ 170	■ 0.06	■ 100	■ 0.05	■ 160	■ 0.06	■ -	■ -	■ -	■ -	■ -	■ -	2.09	2.8



THREAD TURNING

THEARDING – CONTENT

		FULL PROFILE		PARTIAL PROFILE	
		EXTERNAL	INTERNAL	EXTERNAL	INTERNAL
ECONOMY LINE -P1 (directly pressed)	M		M		60°-PP
	UN		UN		60°-PP
	W		W	55°-PP	55°-PP
	NPT		NPT		
PRECISION LINE (all-ground)	M		M		
	M-AL		M-AL	60°-PP	60°-PP
	UN		UN		
	W		W	55°-PP	55°-PP
	TR-S		TR-S	M-S PP	M-S PP

		FULL PROFILE			
		EXTERNAL	INTERNAL	EXTERNAL	INTERNAL
PRECISION LINE (all-ground)	TR		TR	ACME	ACME
	BSPT		BSPT		STACME
	RD		RD	NPT	NPT
				API RD	API RD

TN UN EXT -P1



	IC (mm)	L (mm)	S (mm)
16	9.525	16.50	3.47

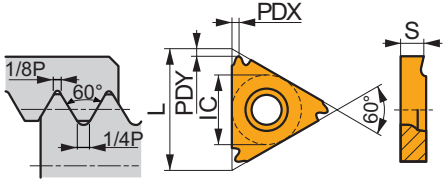

Suitability and starting values for cutting speed (vc). Refer to our Machining Calculator app for further calculations.

Product	RE (mm)	P	M	K	N	S	H	TP (mm)	TPI	PDX (mm)	PDY (mm)
		vc (m/min)	vc (m/min)	vc (m/min)	vc (m/min)	vc (m/min)	vc (m/min)				

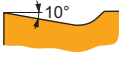

TN UN-P1 ER pressed external, right-handed design, for machining Unified threads, and continuous cuts.

TN 16ER200UN-P1:T8030	●	–	■	■	■	■	■	■	–	–	20.0	0.8	0.8
TN 16ER180UN-P1:T8030	●	–	■	■	■	■	■	■	–	–	18.0	0.8	0.8
TN 16ER160UN-P1:T8030	●	–	■	■	■	■	■	■	–	–	16.0	0.8	0.8
TN 16ER140UN-P1:T8030	●	–	■	■	■	■	■	■	–	–	14.0	1.5	1.2
TN 16ER120UN-P1:T8030	●	–	■	■	■	■	■	■	–	–	12.0	1.5	1.2

TN UN INT -P1



	IC (mm)	L (mm)	S (mm)
16	9.525	16.50	3.47

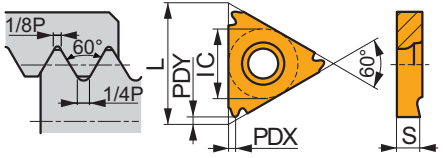

Suitability and starting values for cutting speed (vc). Refer to our Machining Calculator app for further calculations.

Product	RE (mm)	P	M	K	N	S	H	TP (mm)	TPI	PDX (mm)	PDY (mm)
		vc (m/min)	vc (m/min)	vc (m/min)	vc (m/min)	vc (m/min)	vc (m/min)				



TN UN-P1 NR pressed internal, right-handed design, for machining Unified threads, and continuous cuts.

TN 16NR200UN-P1:T8030	●	–	■	■	■	■	■	■	–	–	20.0	0.8	0.8
TN 16NR180UN-P1:T8030	●	–	■	■	■	■	■	■	–	–	18.0	0.8	0.8
TN 16NR160UN-P1:T8030	●	–	■	■	■	■	■	■	–	–	16.0	0.8	0.8
TN 16NR140UN-P1:T8030	●	–	■	■	■	■	■	■	–	–	14.0	1.5	1.2
TN 16NR120UN-P1:T8030	●	–	■	■	■	■	■	■	–	–	12.0	1.5	1.2

TN 60° PP EXT -P1



	IC (mm)	L (mm)	S (mm)
16	9.525	16.50	3.47

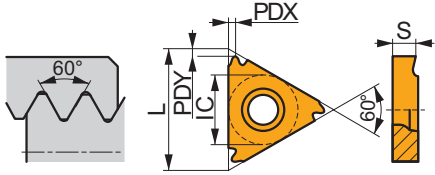

Suitability and starting values for cutting speed (vc). Refer to our Machining Calculator app for further calculations.

Product	RE (mm)	P	M	K	N	S	H	TPN (mm)	TPX (mm)	TPIN (mm)	TPIX (mm)	PDX (mm)	PDY (mm)
		vc (m/min)	vc (m/min)	vc (m/min)	vc (m/min)	vc (m/min)	vc (m/min)						

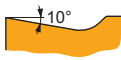
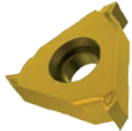

TN M60-P1 PP ER pressed external, right-handed design, for machining Metric and Unified threads, and continuous cuts.

TN 16ERA60-P1:T8030	●	–	160	95	150	480	40	–	0.50	1.50	16	48	0.8	0.6
TN 16ERAG60-P1:T8030	●	–	160	95	150	480	40	–	0.50	3.00	8	48	1.5	1.1
TN 16ERG60-P1:T8030	●	–	160	95	150	480	40	–	1.75	3.00	8	14	1.5	1.2

TN 60° PP INT -P1



	IC (mm)	L (mm)	S (mm)
11	6.350	11.00	3.00
16	9.525	16.50	3.47

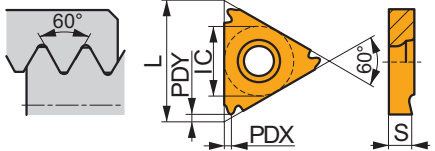

Suitability and starting values for cutting speed (vc). Refer to our Machining Calculator app for further calculations.

Product	RE (mm)	P	M	K	N	S	H	TPN (mm)	TPX (mm)	TPIN (mm)	TPIX (mm)	PDX (mm)	PDY (mm)
		vc (m/min)	vc (m/min)	vc (m/min)	vc (m/min)	vc (m/min)	vc (m/min)						

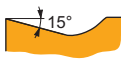
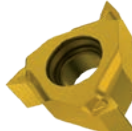

TN M60-P1 PP NR pressed internal, right-handed design, for machining Metric and Unified threads, and continuous cuts.

TN 11NRA60-P1:T8030	●	–	160	95	150	480	40	–	0.50	1.50	16	48	0.8	0.7
TN 16NRAG60-P1:T8030	●	–	160	95	150	480	40	–	0.50	3.00	8	48	1.5	1.1
TN 16NRG60-P1:T8030	●	–	160	95	150	480	40	–	1.75	3.00	8	14	1.5	1.2

TN W EXT -P1



	IC (mm)	L (mm)	S (mm)
16	9.525	16.50	3.47

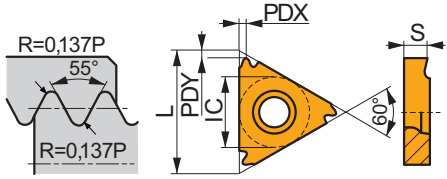

Suitability and starting values for cutting speed (vc). Refer to our Machining Calculator app for further calculations.

Product	RE (mm)	P	M	K	N	S	H	TP (mm)	TPI	PDX (mm)	PDY (mm)
		vc (m/min)	vc (m/min)	vc (m/min)	vc (m/min)	vc (m/min)	vc (m/min)				



TN W-P1 ER pressed external, right-handed design, for machining Whitworth form threads, and continuous cuts.

TN 16ER190W-P1:T8030	●	–	160	95	150	480	40	–	–	19.0	0.8	0.8
TN 16ER140W-P1:T8030	●	–	160	95	150	480	40	–	–	14.0	1.5	1.2
TN 16ER110W-P1:T8030	●	–	160	95	150	480	40	–	–	11.0	1.5	1.2

TN W INT -P1



	IC (mm)	L (mm)	S (mm)
11	6.350	11.00	3.00
16	9.525	16.50	3.47

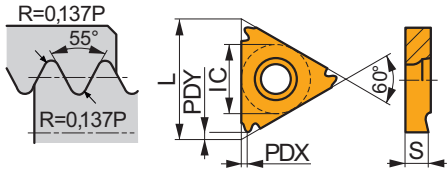

Suitability and starting values for cutting speed (vc). Refer to our Machining Calculator app for further calculations.

Product	RE (mm)	P	M	K	N	S	H	TP (mm)	TPI	PDX (mm)	PDY (mm)
		vc (m/min)	vc (m/min)	vc (m/min)	vc (m/min)	vc (m/min)	vc (m/min)				

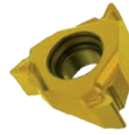

TN W-P1 NR pressed internal, right-handed design, for machining Whitworth form threads, and continuous cuts.

TN 11NR190W-P1:T8030	●	–	160	95	150	480	40	–	–	19.0	0.8	0.8
TN 11NR140W-P1:T8030	●	–	160	95	150	480	40	–	–	14.0	0.9	0.7
TN 16NR140W-P1:T8030	●	–	160	95	150	480	40	–	–	14.0	1.5	1.2
TN 16NR110W-P1:T8030	●	–	160	95	150	480	40	–	–	11.0	1.5	1.2

TN 55° PP EXT -P1



	IC (mm)	L (mm)	S (mm)
16	9.525	16.50	3.47

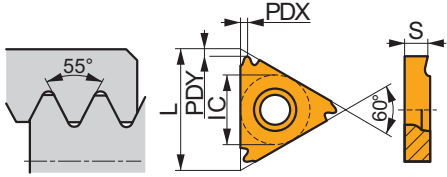

Suitability and starting values for cutting speed (vc). Refer to our Machining Calculator app for further calculations.

Product	RE (mm)	P	M	K	N	S	H	TPN (mm)	TPX (mm)	TPIN	TPIX	PDX (mm)	PDY (mm)
		vc (m/min)	vc (m/min)	vc (m/min)	vc (m/min)	vc (m/min)	vc (m/min)						

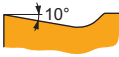
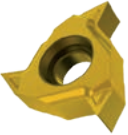

TN W55-P1 PP ER pressed external, right-handed design, for machining Whitworth threads, and continuous cuts.

TN 16ERAG55-P1:T8030	●	–	■	■	■	■	■	■	–	0.50	3.00	8	48	–	–
TN 16ERG55-P1:T8030	●	–	■	■	■	■	■	■	–	1.75	3.00	8	14	–	–

TN 55° PP INT -P1



	IC (mm)	L (mm)	S (mm)
16	9.525	16.50	3.47

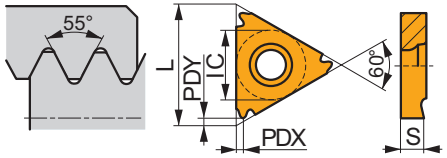

Suitability and starting values for cutting speed (vc). Refer to our Machining Calculator app for further calculations.

Product	RE (mm)	P	M	K	N	S	H	TPN (mm)	TPX (mm)	TPIN	TPIX	PDX (mm)	PDY (mm)
		vc (m/min)	vc (m/min)	vc (m/min)	vc (m/min)	vc (m/min)	vc (m/min)						

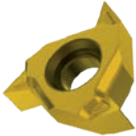

TN W55-P1 PP NR pressed internal, right-handed design, for machining Whitworth threads, and continuous cuts.

TN 16NRAG55-P1:T8030	●	–	■	■	■	■	■	■	–	0.50	1.50	16	48	–	–
-----------------------------	---	---	---	---	---	---	---	---	---	------	------	----	----	---	---

TN NPT EXT -P1



	IC (mm)	L (mm)	S (mm)
16	9.525	16.50	3.47

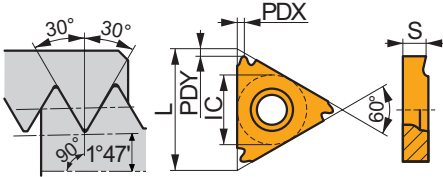

Suitability and starting values for cutting speed (vc). Refer to our Machining Calculator app for further calculations.

Product	RE (mm)	P	M	K	N	S	H	TP (mm)	TPI	PDX (mm)	PDY (mm)
		vc (m/min)	vc (m/min)	vc (m/min)	vc (m/min)	vc (m/min)	vc (m/min)				

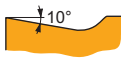

TN NPT-P1 ER pressed external, right-handed design, for machining NPT threads, and continuous cuts.

TN 16ER115NPT-P1:T8030	●	-	■ 160	■ 95	■ 150	☑ 480	☑ 40	-	-	11.5	-	-
------------------------	---	---	-------	------	-------	-------	------	---	---	------	---	---

TN NPT INT -P1



	IC (mm)	L (mm)	S (mm)
16	9.525	16.50	3.47

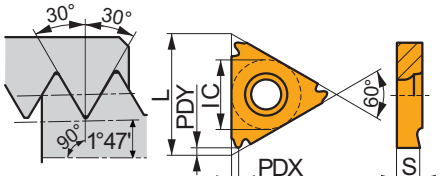

Suitability and starting values for cutting speed (vc). Refer to our Machining Calculator app for further calculations.

Product	RE (mm)	P	M	K	N	S	H	TP (mm)	TPI	PDX (mm)	PDY (mm)
		vc (m/min)	vc (m/min)	vc (m/min)	vc (m/min)	vc (m/min)	vc (m/min)				

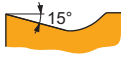
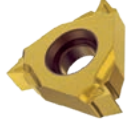

TN NPT-P1 NR pressed internal, right-handed design, for machining NPT threads, and continuous cuts.

TN 16NR115NPT-P1:T8030	●	-	■ 160	■ 95	■ 150	☑ 480	☑ 40	-	-	11.5	-	-
------------------------	---	---	-------	------	-------	-------	------	---	---	------	---	---

TN M EXT



	IC (mm)	L (mm)	S (mm)
16	9.525	16.50	3.47
22	12.700	22.00	4.71

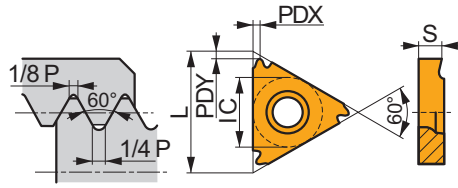

Suitability and starting values for cutting speed (vc). Refer to our Machining Calculator app for further calculations.

Product	RE (mm)	P	M	K	N	S	H	TP (mm)	TPI	PDX (mm)	PDY (mm)
		vc (m/min)	vc (m/min)	vc (m/min)	vc (m/min)	vc (m/min)	vc (m/min)				



TN M ER external, right-handed design, for machining ISO Metric threads, and continuous cuts.

TN 16ER050M:T8010	●	–	■	175	▣	105	■	165	–	▣	40	–	0.50	–	0.8	0.8	
TN 16ER050M:T8030	●	–	■	160	▣	95	■	150	▣	480	▣	40	–	0.50	–	0.8	0.8
TN 16ER075M:T8010	●	–	■	175	▣	105	■	165	–	▣	40	–	0.75	–	0.8	0.8	
TN 16ER075M:T8030	●	–	■	160	▣	95	■	150	▣	480	▣	40	–	0.75	–	0.8	0.8
TN 16ER080M:T8030	●	–	■	160	▣	95	■	150	▣	480	▣	40	–	0.80	–	0.6	0.8
TN 16ER100M:T8010	●	–	■	175	▣	105	■	165	–	▣	40	–	1.00	–	0.8	0.8	
TN 16ER100M:T8030	●	–	■	160	▣	95	■	150	▣	480	▣	40	–	1.00	–	0.8	0.8
TN 16ER125M:T8010	●	–	■	175	▣	105	■	165	–	▣	40	–	1.25	–	0.8	0.8	
TN 16ER125M:T8030	●	–	■	160	▣	95	■	150	▣	480	▣	40	–	1.25	–	0.8	0.8
TN 16ER150M:T8010	●	–	■	175	▣	105	■	165	–	▣	40	–	1.50	–	0.8	0.8	
TN 16ER150M:T8030	●	–	■	160	▣	95	■	150	▣	480	▣	40	–	1.50	–	0.8	0.8
TN 16ER175M:T8010	●	–	■	175	▣	105	■	165	–	▣	40	–	1.75	–	1.5	1.2	
TN 16ER175M:T8030	●	–	■	160	▣	95	■	150	▣	480	▣	40	–	1.75	–	1.5	1.2
TN 16ER200M:T8010	●	–	■	175	▣	105	■	165	–	▣	40	–	2.00	–	1.5	1.2	
TN 16ER200M:T8030	●	–	■	160	▣	95	■	150	▣	480	▣	40	–	2.00	–	1.5	1.2
TN 16ER250M:T8010	●	–	■	175	▣	105	■	165	–	▣	40	–	2.50	–	1.5	1.2	
TN 16ER250M:T8030	●	–	■	160	▣	95	■	150	▣	480	▣	40	–	2.50	–	1.5	1.2
TN 16ER300M:T8010	●	–	■	175	▣	105	■	165	–	▣	40	–	3.00	–	1.5	1.2	
TN 16ER300M:T8030	●	–	■	160	▣	95	■	150	▣	480	▣	40	–	3.00	–	1.5	1.2
TN 16ER350M:T8030 ¹⁾	●	–	■	160	▣	95	■	150	▣	480	▣	40	–	3.50	–	1.7	1.2
TN 22ER350M:T8030	●	–	■	160	▣	95	■	150	▣	480	▣	40	–	3.50	–	2.5	1.8
TN 22ER400M:T8010	●	–	■	175	▣	105	■	165	–	▣	40	–	4.00	–	2.5	1.8	
TN 22ER400M:T8030	●	–	■	160	▣	95	■	150	▣	480	▣	40	–	4.00	–	2.5	1.8
TN 22ER450M:T8030	●	–	■	160	▣	95	■	150	▣	480	▣	40	–	4.50	–	2.5	1.8
TN 22ER500M:T8030	●	–	■	160	▣	95	■	150	▣	480	▣	40	–	5.00	–	2.5	1.8

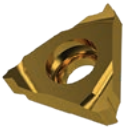

TN M EL external, left-handed design, for machining ISO Metric threads, and continuous cuts.

TN 16EL050M:T8030	●	–	■	160	▣	95	■	150	▣	480	▣	40	–	0.50	–	0.8	0.8
TN 16EL075M:T8030	●	–	■	160	▣	95	■	150	▣	480	▣	40	–	0.75	–	0.8	0.8
TN 16EL080M:T8030	●	–	■	160	▣	95	■	150	▣	480	▣	40	–	0.80	–	0.6	0.8
TN 16EL100M:T8010	●	–	■	175	▣	105	■	165	–	▣	40	–	1.00	–	0.8	0.8	
TN 16EL100M:T8030	●	–	■	160	▣	95	■	150	▣	480	▣	40	–	1.00	–	0.8	0.8
TN 16EL125M:T8030	●	–	■	160	▣	95	■	150	▣	480	▣	40	–	1.25	–	0.8	0.8
TN 16EL150M:T8010	●	–	■	175	▣	105	■	165	–	▣	40	–	1.50	–	0.8	0.8	
TN 16EL150M:T8030	●	–	■	160	▣	95	■	150	▣	480	▣	40	–	1.50	–	0.8	0.8
TN 16EL175M:T8030	●	–	■	160	▣	95	■	150	▣	480	▣	40	–	1.75	–	1.5	1.2
TN 16EL200M:T8030	●	–	■	160	▣	95	■	150	▣	480	▣	40	–	2.00	–	1.5	1.2
TN 16EL250M:T8030	●	–	■	160	▣	95	■	150	▣	480	▣	40	–	2.50	–	1.5	1.2
TN 16EL300M:T8010	●	–	■	175	▣	105	■	165	–	▣	40	–	3.00	–	1.5	1.2	
TN 16EL300M:T8030	●	–	■	160	▣	95	■	150	▣	480	▣	40	–	3.00	–	1.5	1.2
TN 22EL350M:T8030	●	–	■	160	▣	95	■	150	▣	480	▣	40	–	3.50	–	2.5	1.8
TN 22EL400M:T8030	●	–	■	160	▣	95	■	150	▣	480	▣	40	–	4.00	–	2.5	1.8
TN 22EL450M:T8030	●	–	■	160	▣	95	■	150	▣	480	▣	40	–	4.50	–	2.5	1.8

¹⁾ Toolholders have to be modified.

TN M INT



	IC (mm)	L (mm)	S (mm)
11	6.350	11.00	3.00
16	9.525	16.50	3.47
22	12.700	22.00	4.71

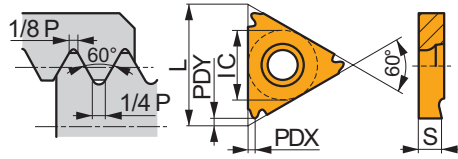

Suitability and starting values for cutting speed (vc). Refer to our Machining Calculator app for further calculations.

Product	RE (mm)	P	M	K	N	S	H	TP (mm)	TPI	PDX (mm)	PDY (mm)
		vc (m/min)	vc (m/min)	vc (m/min)	vc (m/min)	vc (m/min)	vc (m/min)				

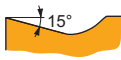
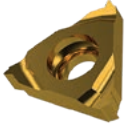

TN M NR internal, right-handed design, for machining ISO Metric threads, and continuous cuts.

TN 11NR050M:T8030	●	–	■	160	■	95	■	150	☑	480	☑	40	–	0.50	–	0.8	0.8
TN 11NR075M:T8010	●	–	■	175	☑	105	■	165	–	–	☑	40	–	0.75	–	0.8	0.8
TN 11NR075M:T8030	●	–	■	160	■	95	■	150	☑	480	☑	40	–	0.75	–	0.8	0.8
TN 11NR100M:T8030	●	–	■	160	■	95	■	150	☑	480	☑	40	–	1.00	–	0.8	0.8
TN 11NR125M:T8030	●	–	■	160	■	95	■	150	☑	480	☑	40	–	1.25	–	0.8	0.8
TN 11NR150M:T8010	●	–	■	175	☑	105	■	165	–	–	☑	40	–	1.50	–	0.8	0.8
TN 11NR150M:T8030	●	–	■	160	■	95	■	150	☑	480	☑	40	–	1.50	–	0.8	0.8
TN 11NR200M:T8010	●	–	■	175	☑	105	■	165	–	–	☑	40	–	2.00	–	0.9	0.8
TN 11NR200M:T8030	●	–	■	160	■	95	■	150	☑	480	☑	40	–	2.00	–	0.9	0.8
TN 16NR050M:T8030	●	–	■	160	■	95	■	150	☑	480	☑	40	–	0.50	–	0.8	0.8
TN 16NR075M:T8030	●	–	■	160	■	95	■	150	☑	480	☑	40	–	0.75	–	0.8	0.8
TN 16NR100M:T8010	●	–	■	175	☑	105	■	165	–	–	☑	40	–	1.00	–	0.8	0.8
TN 16NR100M:T8030	●	–	■	160	■	95	■	150	☑	480	☑	40	–	1.00	–	0.8	0.8
TN 16NR125M:T8030	●	–	■	160	■	95	■	150	☑	480	☑	40	–	1.25	–	0.8	0.8
TN 16NR150M:T8010	●	–	■	175	☑	105	■	165	–	–	☑	40	–	1.50	–	0.8	0.8
TN 16NR150M:T8030	●	–	■	160	■	95	■	150	☑	480	☑	40	–	1.50	–	0.8	0.8
TN 16NR175M:T8030	●	–	■	160	■	95	■	150	☑	480	☑	40	–	1.75	–	1.5	1.2
TN 16NR200M:T8010	●	–	■	175	☑	105	■	165	–	–	☑	40	–	2.00	–	1.5	1.2
TN 16NR200M:T8030	●	–	■	160	■	95	■	150	☑	480	☑	40	–	2.00	–	1.5	1.2
TN 16NR250M:T8010	●	–	■	175	☑	105	■	165	–	–	☑	40	–	2.50	–	1.5	1.2
TN 16NR250M:T8030	●	–	■	160	■	95	■	150	☑	480	☑	40	–	2.50	–	1.5	1.2
TN 16NR300M:T8010	●	–	■	175	☑	105	■	165	–	–	☑	40	–	3.00	–	1.5	1.2
TN 16NR300M:T8030	●	–	■	160	■	95	■	150	☑	480	☑	40	–	3.00	–	1.5	1.2
TN 16NR350M:T8030 ¹⁾	●	–	■	160	■	95	■	150	☑	480	☑	40	–	3.50	–	1.6	1.2
TN 22NR350M:T8030	●	–	■	160	■	95	■	150	☑	480	☑	40	–	3.50	–	2.5	1.8
TN 22NR400M:T8010	●	–	■	175	☑	105	■	165	–	–	☑	40	–	4.00	–	2.5	1.8
TN 22NR400M:T8030	●	–	■	160	■	95	■	150	☑	480	☑	40	–	4.00	–	2.5	1.8
TN 22NR450M:T8010	●	–	■	175	☑	105	■	165	–	–	☑	40	–	4.50	–	2.5	1.8
TN 22NR450M:T8030	●	–	■	160	■	95	■	150	☑	480	☑	40	–	4.50	–	2.5	1.8
TN 22NR500M:T8010	●	–	■	175	☑	105	■	165	–	–	☑	40	–	5.00	–	2.5	1.8
TN 22NR500M:T8030	●	–	■	160	■	95	■	150	☑	480	☑	40	–	5.00	–	2.5	1.8

Suitability and starting values for cutting speed (vc). Refer to our Machining Calculator app for further calculations.

Product	RE (mm)	P	M	K	N	S	H	TP (mm)	TPI	PDX (mm)	PDY (mm)
		vc (m/min)	vc (m/min)	vc (m/min)	vc (m/min)	vc (m/min)	vc (m/min)				

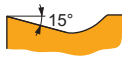

TN M NL internal, left-handed design, for machining ISO Metric threads, and continuous cuts.

TN 11NL050M:T8030	●	–	■	160	■	95	■	150	▣	480	▣	40	–	0.50	–	0.8	0.8
TN 11NL100M:T8030	●	–	■	160	■	95	■	150	▣	480	▣	40	–	1.00	–	0.8	0.8
TN 11NL150M:T8030	●	–	■	160	■	95	■	150	▣	480	▣	40	–	1.50	–	0.8	0.8
TN 11NL200M:T8030	●	–	■	160	■	95	■	150	▣	480	▣	40	–	2.00	–	0.9	0.8
TN 16NL100M:T8030	●	–	■	160	■	95	■	150	▣	480	▣	40	–	1.00	–	0.8	0.8
TN 16NL125M:T8030	●	–	■	160	■	95	■	150	▣	480	▣	40	–	1.25	–	0.8	0.8
TN 16NL150M:T8010	●	–	■	175	▣	105	■	165	–	–	▣	40	–	1.50	–	0.8	0.8
TN 16NL150M:T8030	●	–	■	160	■	95	■	150	▣	480	▣	40	–	1.50	–	0.8	0.8
TN 16NL175M:T8030	●	–	■	160	■	95	■	150	▣	480	▣	40	–	1.75	–	1.5	1.2
TN 16NL200M:T8010	●	–	■	175	▣	105	■	165	–	–	▣	40	–	2.00	–	1.5	1.2
TN 16NL200M:T8030	●	–	■	160	■	95	■	150	▣	480	▣	40	–	2.00	–	1.5	1.2
TN 16NL250M:T8030	●	–	■	160	■	95	■	150	▣	480	▣	40	–	2.50	–	1.5	1.2
TN 16NL300M:T8010	●	–	■	175	▣	105	■	165	–	–	▣	40	–	3.00	–	1.5	1.2
TN 16NL300M:T8030	●	–	■	160	■	95	■	150	▣	480	▣	40	–	3.00	–	1.5	1.2
TN 22NL350M:T8030	●	–	■	160	■	95	■	150	▣	480	▣	40	–	3.50	–	2.5	1.8
TN 22NL400M:T8030	●	–	■	160	■	95	■	150	▣	480	▣	40	–	4.00	–	2.5	1.8

¹⁾ Toolholders have to be modified.

TN UN EXT



	IC (mm)	L (mm)	S (mm)
16	9.525	16.50	3.47
22	12.700	22.00	4.71

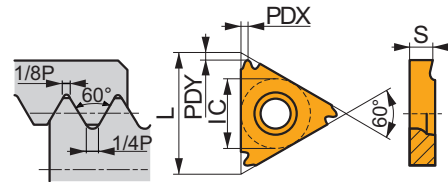

Suitability and starting values for cutting speed (vc). Refer to our Machining Calculator app for further calculations.

Product	RE (mm)	P	M	K	N	S	H	TP (mm)	TPI	PDX (mm)	PDY (mm)
		vc (m/min)	vc (m/min)	vc (m/min)	vc (m/min)	vc (m/min)	vc (m/min)				

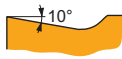
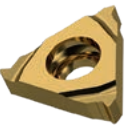

TN UN ER external, right-handed design, for machining Unified threads and continuous cuts.

TN 16ER320UN:T8030	●	–	■	160	■	95	■	150	▣	480	▣	40	–	–	32.0	0.8	0.8
TN 16ER280UN:T8030	●	–	■	160	■	95	■	150	▣	480	▣	40	–	–	28.0	0.8	0.8
TN 16ER240UN:T8030	●	–	■	160	■	95	■	150	▣	480	▣	40	–	–	24.0	0.8	0.8
TN 16ER200UN:T8010	●	–	■	175	▣	105	■	165	–	–	▣	40	–	–	20.0	0.8	0.8
TN 16ER200UN:T8030	●	–	■	160	■	95	■	150	▣	480	▣	40	–	–	20.0	0.8	0.8
TN 16ER180UN:T8030	●	–	■	160	■	95	■	150	▣	480	▣	40	–	–	18.0	0.8	0.8
TN 16ER160UN:T8030	●	–	■	160	■	95	■	150	▣	480	▣	40	–	–	16.0	0.8	0.8
TN 16ER140UN:T8030	●	–	■	160	■	95	■	150	▣	480	▣	40	–	–	14.0	1.5	1.2
TN 16ER130UN:T8030	●	–	■	160	■	95	■	150	▣	480	▣	40	–	–	13.0	1.5	1.2
TN 16ER120UN:T8030	●	–	■	160	■	95	■	150	▣	480	▣	40	–	–	12.0	1.5	1.2
TN 16ER110UN:T8030	●	–	■	160	■	95	■	150	▣	480	▣	40	–	–	11.0	1.5	1.2
TN 16ER100UN:T8030	●	–	■	160	■	95	■	150	▣	480	▣	40	–	–	10.0	1.5	1.2
TN 16ER090UN:T8030	●	–	■	160	■	95	■	150	▣	480	▣	40	–	–	9.0	1.5	1.2
TN 16ER080UN:T8030	●	–	■	160	■	95	■	150	▣	480	▣	40	–	–	8.0	1.5	1.2
TN 22ER070UN:T8030	●	–	■	160	■	95	■	150	▣	480	▣	40	–	–	7.0	2.5	1.8
TN 22ER060UN:T8030	●	–	■	160	■	95	■	150	▣	480	▣	40	–	–	6.0	2.5	1.8

Suitability and starting values for cutting speed (vc). Refer to our Machining Calculator app for further calculations.

Product	RE (mm)	P	M	K	N	S	H	TP (mm)	TPI	PDX (mm)	PDY (mm)
		vc (m/min)	vc (m/min)	vc (m/min)	vc (m/min)	vc (m/min)	vc (m/min)				

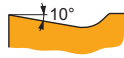
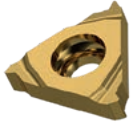

TN UN EL external, left-handed design, for machining Unified threads, and continuous cuts.

TN 16EL200UN:T8030	●	–	■	160	■	95	■	150	■	480	■	40	–	–	20.0	0.8	0.8
TN 16EL120UN:T8030	●	–	■	160	■	95	■	150	■	480	■	40	–	–	12.0	1.5	1.2
TN 16EL100UN:T8030	●	–	■	160	■	95	■	150	■	480	■	40	–	–	10.0	1.5	1.2

TN UN INT



	IC (mm)	L (mm)	S (mm)
16	9.525	16.50	3.47
22	12.700	22.00	4.71

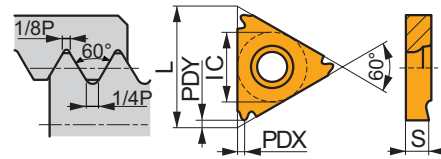

Suitability and starting values for cutting speed (vc). Refer to our Machining Calculator app for further calculations.

Product	RE (mm)	P	M	K	N	S	H	TP (mm)	TPI	PDX (mm)	PDY (mm)
		vc (m/min)	vc (m/min)	vc (m/min)	vc (m/min)	vc (m/min)	vc (m/min)				



TN UN NR internal, right-handed design, for machining Unified threads, and continuous cuts.

TN 16NR200UN:T8030	●	–	■	160	■	95	■	150	■	480	■	40	–	–	20.0	0.8	0.8
TN 16NR180UN:T8030	●	–	■	160	■	95	■	150	■	480	■	40	–	–	18.0	0.8	0.8
TN 16NR160UN:T8030	●	–	■	160	■	95	■	150	■	480	■	40	–	–	16.0	0.8	0.8
TN 16NR140UN:T8030	●	–	■	160	■	95	■	150	■	480	■	40	–	–	14.0	1.5	1.2
TN 16NR120UN:T8030	●	–	■	160	■	95	■	150	■	480	■	40	–	–	12.0	1.5	1.2
TN 16NR110UN:T8030	●	–	■	160	■	95	■	150	■	480	■	40	–	–	11.0	1.5	1.2
TN 16NR100UN:T8030	●	–	■	160	■	95	■	150	■	480	■	40	–	–	10.0	1.5	1.2
TN 16NR080UN:T8030	●	–	■	160	■	95	■	150	■	480	■	40	–	–	8.0	1.5	1.2
TN 22NR050UN:T8030	●	–	■	160	■	95	■	150	■	480	■	40	–	–	5.0	2.5	1.8

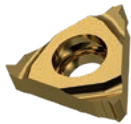

TN UN NL internal, left-handed design, for machining Unified threads, and continuous cuts.

TN 16NL120UN:T8030	●	–	■	160	■	95	■	150	■	480	■	40	–	–	12.0	1.5	1.2
TN 16NL080UN:T8030	●	–	■	160	■	95	■	150	■	480	■	40	–	–	8.0	1.5	1.2

TN 60° PP EXT



	IC (mm)	L (mm)	S (mm)
16	9.525	16.50	3.47
22	12.700	22.00	4.71

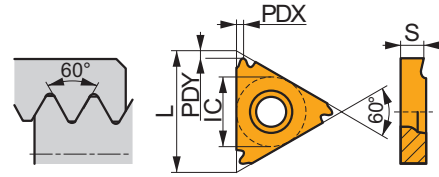

Suitability and starting values for cutting speed (vc). Refer to our Machining Calculator app for further calculations.

Product	RE (mm)	P	M	K	N	S	H	TPN (mm)	TPX (mm)	TPIN	TPIX	PDX (mm)	PDY (mm)
		vc (m/min)	vc (m/min)	vc (m/min)	vc (m/min)	vc (m/min)	vc (m/min)						

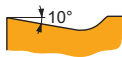

TN M60 PP ER external, right-handed design, for machining Metric and Unified threads, and continuous cuts.

TN 16ERA60:T8030	●	–	160	95	150	480	40	–	0.50	1.50	16	48	0.8	0.6
TN 16ERAG60:T8010	●	–	175	105	165	–	40	–	0.50	3.00	8	48	1.5	1.1
TN 16ERAG60:T8030	●	–	160	95	150	480	40	–	0.50	3.00	8	48	1.5	1.1
TN 16ERG60:T8010	●	–	175	105	165	–	40	–	1.75	3.00	8	14	1.5	1.1
TN 16ERG60:T8030	●	–	160	95	150	480	40	–	1.75	3.00	8	14	1.5	1.1
TN 22ERN60:T8010	●	–	175	105	165	–	40	–	3.50	5.00	5	7	2.5	1.8
TN 22ERN60:T8030	●	–	160	95	150	480	40	–	3.50	5.00	5	7	2.5	1.8

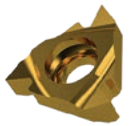

TN M60 PP EL external, left-handed design, for machining Metric and Unified threads, and continuous cuts.

TN 16ELA60:T8030	●	–	160	95	150	480	40	–	0.50	1.50	16	48	0.8	0.6
TN 16ELAG60:T8010	●	–	175	105	165	–	40	–	0.50	3.00	8	48	1.5	1.1
TN 16ELAG60:T8030	●	–	160	95	150	480	40	–	0.50	3.00	8	48	1.5	1.1
TN 16ELG60:T8030	●	–	160	95	150	480	40	–	1.75	3.00	8	14	1.5	1.1
TN 22ELN60:T8030	●	–	160	95	150	480	40	–	3.50	5.00	5	7	2.5	1.8

TN 60° PP INT



	IC (mm)	L (mm)	S (mm)
11	6.350	11.00	3.00
16	9.525	16.50	3.47
22	12.700	22.00	4.71

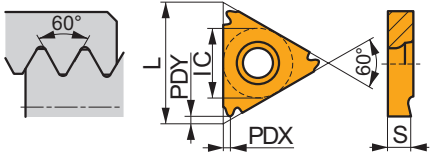

Suitability and starting values for cutting speed (vc). Refer to our Machining Calculator app for further calculations.

Product	RE (mm)	P	M	K	N	S	H	TPN (mm)	TPX (mm)	TPIN	TPIX	PDX (mm)	PDY (mm)
		vc (m/min)	vc (m/min)	vc (m/min)	vc (m/min)	vc (m/min)	vc (m/min)						

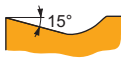
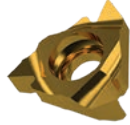

TN M60 PP NR internal, right-handed design, for machining Metric and Unified threads, and continuous cuts.

TN 11NRA60:T8030	●	–	160	95	150	480	40	–	0.50	1.50	16	48	0.8	0.7
TN 16NRA60:T8030	●	–	160	95	150	480	40	–	0.50	1.50	16	48	0.8	0.7
TN 16NRAG60:T8010	●	–	175	105	165	–	40	–	0.50	3.00	8	48	1.5	1.1
TN 16NRAG60:T8030	●	–	160	95	150	480	40	–	0.50	3.00	8	48	1.5	1.1
TN 16NRG60:T8030	●	–	160	95	150	480	40	–	1.75	3.00	8	14	1.5	1.1
TN 22NRN60:T8010	●	–	175	105	165	–	40	–	3.50	5.00	5	7	2.5	1.8
TN 22NRN60:T8030	●	–	160	95	150	480	40	–	3.50	5.00	5	7	2.5	1.8

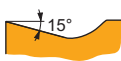

TN M60 PP NL internal, left-handed design, for machining Metric and Unified threads, and continuous cuts.

TN 11NLA60:T8030	●	–	160	95	150	480	40	–	0.50	1.50	16	48	0.8	0.7
TN 16NLAG60:T8030	●	–	160	95	150	480	40	–	0.50	3.00	8	48	1.5	1.1
TN 22NLN60:T8030	●	–	160	95	150	480	40	–	3.50	5.00	5	7	2.5	1.8

TN W EXT



	IC (mm)	L (mm)	S (mm)
16	9.525	16.50	3.47
22	12.700	22.00	4.71

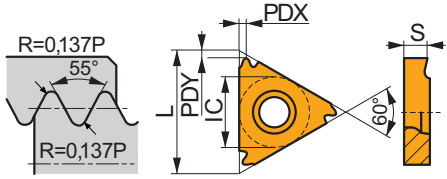

Suitability and starting values for cutting speed (vc). Refer to our Machining Calculator app for further calculations.

Product	RE (mm)	P	M	K	N	S	H	TP (mm)	TPI	PDX (mm)	PDY (mm)
		vc (m/min)	vc (m/min)	vc (m/min)	vc (m/min)	vc (m/min)	vc (m/min)				

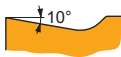

TN W ER external, right-handed design, for machining Whitworth form threads, and continuous cuts.

TN 16ER280W:T8030	●	–	■	160	■	95	■	150	☑	480	☑	40	–	–	28.0	0.8	0.8
TN 16ER240W:T8030	●	–	■	160	■	95	■	150	☑	480	☑	40	–	–	24.0	0.8	0.8
TN 16ER200W:T8030	●	–	■	160	■	95	■	150	☑	480	☑	40	–	–	20.0	0.8	0.8
TN 16ER190W:T8010	●	–	■	175	☑	105	■	165	–	–	☑	40	–	–	19.0	0.8	0.8
TN 16ER190W:T8030	●	–	■	160	■	95	■	150	☑	480	☑	40	–	–	19.0	0.8	0.8
TN 16ER180W:T8030	●	–	■	160	■	95	■	150	☑	480	☑	40	–	–	18.0	0.8	0.8
TN 16ER160W:T8030	●	–	■	160	■	95	■	150	☑	480	☑	40	–	–	16.0	0.8	0.8
TN 16ER140W:T8030	●	–	■	160	■	95	■	150	☑	480	☑	40	–	–	14.0	1.5	1.2
TN 16ER120W:T8030	●	–	■	160	■	95	■	150	☑	480	☑	40	–	–	12.0	1.5	1.2
TN 16ER110W:T8010	●	–	■	175	☑	105	■	165	–	–	☑	40	–	–	11.0	1.5	1.2
TN 16ER110W:T8030	●	–	■	160	■	95	■	150	☑	480	☑	40	–	–	11.0	1.5	1.2
TN 16ER100W:T8030	●	–	■	160	■	95	■	150	☑	480	☑	40	–	–	10.0	1.5	1.2
TN 16ER080W:T8030	●	–	■	160	■	95	■	150	☑	480	☑	40	–	–	8.0	1.5	1.2
TN 22ER070W:T8030	●	–	■	160	■	95	■	150	☑	480	☑	40	–	–	7.0	2.5	1.8
TN 22ER060W:T8030	●	–	■	160	■	95	■	150	☑	480	☑	40	–	–	6.0	2.5	1.8
TN 22ER050W:T8030	●	–	■	160	■	95	■	150	☑	480	☑	40	–	–	5.0	2.5	1.7

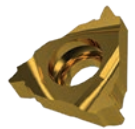

TN W EL external, left-handed design, for machining Whitworth form threads, and continuous cuts.

TN 16EL190W:T8030	●	–	■	160	■	95	■	150	☑	480	☑	40	–	–	19.0	0.8	0.8
TN 16EL140W:T8030	●	–	■	160	■	95	■	150	☑	480	☑	40	–	–	14.0	1.5	1.2
TN 16EL120W:T8030	●	–	■	160	■	95	■	150	☑	480	☑	40	–	–	12.0	1.5	1.2
TN 16EL110W:T8030	●	–	■	160	■	95	■	150	☑	480	☑	40	–	–	11.0	1.5	1.2
TN 16EL100W:T8030	●	–	■	160	■	95	■	150	☑	480	☑	40	–	–	10.0	1.5	1.2
TN 16EL080W:T8030	●	–	■	160	■	95	■	150	☑	480	☑	40	–	–	8.0	1.5	1.2

TN W INT



	IC (mm)	L (mm)	S (mm)
11	6.350	11.00	3.00
16	9.525	16.50	3.47
22	12.700	22.00	4.71

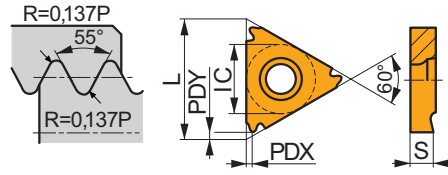

Suitability and starting values for cutting speed (vc). Refer to our Machining Calculator app for further calculations.

Product	RE (mm)	P	M	K	N	S	H	TP (mm)	TPI	PDX (mm)	PDY (mm)
		vc (m/min)	vc (m/min)	vc (m/min)	vc (m/min)	vc (m/min)	vc (m/min)				

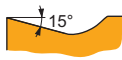
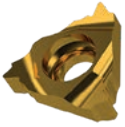

TN W NR internal, right-handed design, for machining Whitworth form threads, and continuous cuts.

TN 11NR190W:T8030	●	–	■	160	■	95	■	150	▣	480	▣	40	–	–	19.0	0.8	0.8
TN 11NR140W:T8010	●	–	■	175	▣	105	■	165	–	–	▣	40	–	–	14.0	0.9	0.7
TN 11NR140W:T8030	●	–	■	160	■	95	■	150	▣	480	▣	40	–	–	14.0	0.9	0.7
TN 16NR280W:T8030	●	–	■	160	■	95	■	150	▣	480	▣	40	–	–	28.0	0.8	0.8
TN 16NR190W:T8010	●	–	■	175	▣	105	■	165	–	–	▣	40	–	–	19.0	0.8	0.8
TN 16NR190W:T8030	●	–	■	160	■	95	■	150	▣	480	▣	40	–	–	19.0	0.8	0.8
TN 16NR160W:T8030	●	–	■	160	■	95	■	150	▣	480	▣	40	–	–	16.0	0.8	0.8
TN 16NR140W:T8010	●	–	■	175	▣	105	■	165	–	–	▣	40	–	–	14.0	1.5	1.2
TN 16NR140W:T8030	●	–	■	160	■	95	■	150	▣	480	▣	40	–	–	14.0	1.5	1.2
TN 16NR120W:T8030	●	–	■	160	■	95	■	150	▣	480	▣	40	–	–	12.0	1.5	1.2
TN 16NR110W:T8010	●	–	■	175	▣	105	■	165	–	–	▣	40	–	–	11.0	1.5	1.2
TN 16NR110W:T8030	●	–	■	160	■	95	■	150	▣	480	▣	40	–	–	11.0	1.5	1.2
TN 16NR100W:T8030	●	–	■	160	■	95	■	150	▣	480	▣	40	–	–	10.0	1.5	1.2
TN 16NR090W:T8030	●	–	■	160	■	95	■	150	▣	480	▣	40	–	–	9.0	1.5	1.2
TN 16NR080W:T8030	●	–	■	160	■	95	■	150	▣	480	▣	40	–	–	8.0	1.5	1.2
TN 22NR060W:T8030	●	–	■	160	■	95	■	150	▣	480	▣	40	–	–	6.0	2.5	1.8
TN 22NR050W:T8030	●	–	■	160	■	95	■	150	▣	480	▣	40	–	–	5.0	2.5	1.7



TN W NL internal, left-handed design, for machining Whitworth form threads, and continuous cuts.

TN 16NL140W:T8030	●	–	■	160	■	95	■	150	▣	480	▣	40	–	–	14.0	1.5	1.2
TN 16NL120W:T8030	●	–	■	160	■	95	■	150	▣	480	▣	40	–	–	12.0	1.5	1.2
TN 16NL110W:T8030	●	–	■	160	■	95	■	150	▣	480	▣	40	–	–	11.0	1.5	1.2
TN 16NL100W:T8030	●	–	■	160	■	95	■	150	▣	480	▣	40	–	–	10.0	1.5	1.2
TN 16NL080W:T8030	●	–	■	160	■	95	■	150	▣	480	▣	40	–	–	8.0	1.5	1.2

TN 55° PP EXT



	IC (mm)	L (mm)	S (mm)
16	9.525	16.50	3.47
22	12.700	22.00	4.71

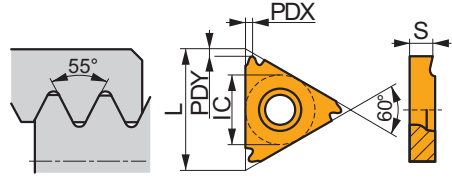

Suitability and starting values for cutting speed (vc). Refer to our Machining Calculator app for further calculations.

Product	RE (mm)	P	M	K	N	S	H	TPN (mm)	TPX (mm)	TPIN (mm)	TPIX (mm)	PDX (mm)	PDY (mm)
		vc (m/min)	vc (m/min)	vc (m/min)	vc (m/min)	vc (m/min)							

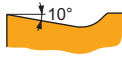

TN W55 PP ER external, right-handed design, for machining Whitworth threads, and continuous cuts.

TN 16ERA55:T8030	●	–	■	■	■	■	■	■	–	0.50	1.50	16	48	0.8	0.6
TN 16ERAG55:T8010	●	–	■	■	■	■	■	■	–	0.50	3.00	8	48	1.5	1.1
TN 16ERAG55:T8030	●	–	■	■	■	■	■	■	–	0.50	3.00	8	48	1.5	1.1
TN 16ERG55:T8030	●	–	■	■	■	■	■	■	–	1.75	3.00	8	14	1.5	1.1
TN 22ERN55:T8010	●	–	■	■	■	■	■	■	–	3.50	5.00	5	7	2.5	1.8
TN 22ERN55:T8030	●	–	■	■	■	■	■	■	–	3.50	5.00	5	7	2.5	1.8

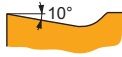

TN W55 PP EL external, left-handed design, for machining Whitworth threads, and continuous cuts.

TN 16ELAG55:T8030	●	–	■	■	■	■	■	■	–	0.50	3.00	8	48	1.5	1.1
TN 16ELG55:T8030	●	–	■	■	■	■	■	■	–	1.75	3.00	8	14	1.5	1.1
TN 22ELN55:T8030	●	–	■	■	■	■	■	■	–	3.50	5.00	5	7	2.5	1.8

TN 55° PP INT



	IC (mm)	L (mm)	S (mm)
11	6.350	11.00	3.00
16	9.525	16.50	3.47
22	12.700	22.00	4.71

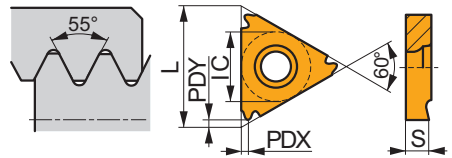

Suitability and starting values for cutting speed (vc). Refer to our Machining Calculator app for further calculations.

Product	RE (mm)	P	M	K	N	S	H	TPN (mm)	TPX (mm)	TPIN (mm)	TPIX (mm)	PDX (mm)	PDY (mm)
		vc (m/min)	vc (m/min)	vc (m/min)	vc (m/min)	vc (m/min)							

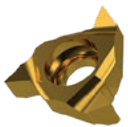

TN W55 PP NR internal, right-handed design, for machining Whitworth threads, and continuous cuts.

TN 11NRA55:T8030	●	–	■	■	■	■	■	■	–	0.50	1.50	16	48	0.8	0.6
TN 16NRA55:T8030	●	–	■	■	■	■	■	■	–	0.50	1.50	16	48	0.8	0.6
TN 16NRAG55:T8010	●	–	■	■	■	■	■	■	–	0.50	3.00	8	48	1.5	1.1
TN 16NRAG55:T8030	●	–	■	■	■	■	■	■	–	0.50	3.00	8	48	1.5	1.1
TN 16NRG55:T8030	●	–	■	■	■	■	■	■	–	1.75	3.00	8	14	1.5	1.1
TN 22NRN55:T8030	●	–	■	■	■	■	■	■	–	3.50	5.00	5	7	2.5	1.8

Suitability and starting values for cutting speed (vc). Refer to our Machining Calculator app for further calculations.

Product	RE (mm)	P	M	K	N	S	H	TPN (mm)	TPX (mm)	TPIN	TPIX	PDX (mm)	PDY (mm)
		vc (m/min)	vc (m/min)	vc (m/min)	vc (m/min)	vc (m/min)	vc (m/min)						

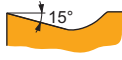

TN W55 PP NL internal, left-handed design, for machining Whitworth threads, and continuous cuts.

TN 11NLA55:T8030	●	–	160	95	150	480	40	–	0.50	1.50	16	48	0.8	0.6
TN 16NLA55:T8030	●	–	160	95	150	480	40	–	0.50	1.50	16	48	0.8	0.6
TN 16NLAG55:T8030	●	–	160	95	150	480	40	–	0.50	3.00	8	48	1.5	1.1
TN 16NLG55:T8030	●	–	160	95	150	480	40	–	1.75	3.00	8	14	1.5	1.1

TN NPT EXT



IC (mm)	L (mm)	S (mm)	
16	9.525	16.50	3.47

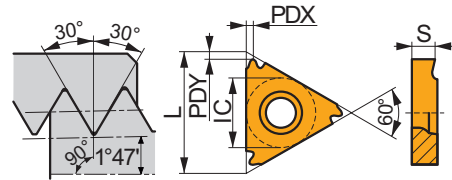

Suitability and starting values for cutting speed (vc). Refer to our Machining Calculator app for further calculations.

Product	RE (mm)	P	M	K	N	S	H	TP (mm)	TPI	PDX (mm)	PDY (mm)
		vc (m/min)	vc (m/min)	vc (m/min)	vc (m/min)	vc (m/min)	vc (m/min)				

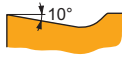

TN NPT ER external, right-handed design, for machining NPT threads, and continuous cuts.

TN 16ER270NPT:T8030	●	–	160	95	150	480	40	–	–	27.0	0.8	0.7
TN 16ER180NPT:T8030	●	–	160	95	150	480	40	–	–	18.0	0.8	0.7
TN 16ER140NPT:T8030	●	–	160	95	150	480	40	–	–	14.0	1.5	1.1
TN 16ER115NPT:T8030	●	–	160	95	150	480	40	–	–	11.5	1.5	1.1
TN 16ER080NPT:T8030	●	–	160	95	150	480	40	–	–	8.0	1.6	1.1

TN NPT INT



	IC (mm)	L (mm)	S (mm)
11	6.350	11.00	3.00
16	9.525	16.50	3.47

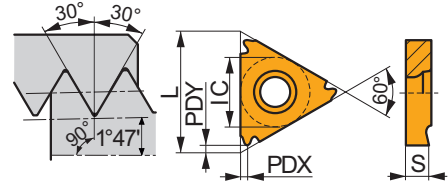

Suitability and starting values for cutting speed (vc). Refer to our Machining Calculator app for further calculations.

Product	RE (mm)	P	M	K	N	S	H	TP (mm)	TPI	PDX (mm)	PDY (mm)
		vc (m/min)	vc (m/min)	vc (m/min)	vc (m/min)	vc (m/min)	vc (m/min)				

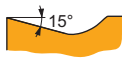
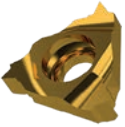

TN NPT NR internal, right-handed design, for machining NPT threads, and continuous cuts.

TN 11NR180NPT:T8030	●	–	160	95	150	480	40	–	–	18.0	0.8	0.7
TN 11NR140NPT:T8030	●	–	160	95	150	480	40	–	–	14.0	1.0	0.7
TN 16NR140NPT:T8010	●	–	175	105	165	–	40	–	–	14.0	1.5	1.1
TN 16NR140NPT:T8030	●	–	160	95	150	480	40	–	–	14.0	1.5	1.1
TN 16NR115NPT:T8010	●	–	175	105	165	–	40	–	–	11.5	1.5	1.1
TN 16NR115NPT:T8030	●	–	160	95	150	480	40	–	–	11.5	1.5	1.1
TN 16NR080NPT:T8030	●	–	160	95	150	480	40	–	–	8.0	1.6	1.1

TN TR-S EXT



	IC (mm)	L (mm)	S (mm)
22	12.700	22.00	4.60

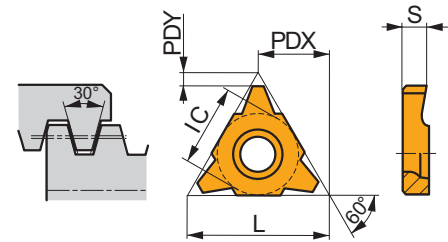

Suitability and starting values for cutting speed (vc). Refer to our Machining Calculator app for further calculations.

Product	RE (mm)	P	M	K	N	S	H	TP (mm)	TPI	PDX (mm)	PDY (mm)
		vc (m/min)	vc (m/min)	vc (m/min)	vc (m/min)	vc (m/min)	vc (m/min)				



TN TR-S EN external, left and right-handed design for machining Trapezoidal threads, and continuous cuts.

TN 22EN600TR:T8030	●	–	160	95	150	480	40	6.00	–	11.0	1.9
TN 22EN700TR:T8030	●	–	160	95	150	480	40	7.00	–	11.0	2.3

TN TR-S INT



	IC (mm)	L (mm)	S (mm)
22	12.700	22.00	4.60

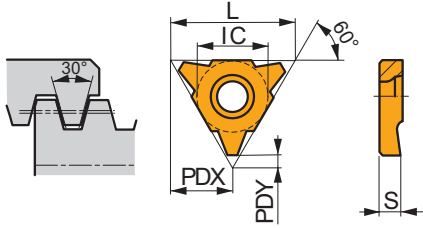

Suitability and starting values for cutting speed (vc). Refer to our Machining Calculator app for further calculations.

Product	RE (mm)	P	M	K	N	S	H	TP (mm)	TPI	PDX (mm)	PDY (mm)
		vc (m/min)	vc (m/min)	vc (m/min)	vc (m/min)	vc (m/min)	vc (m/min)				

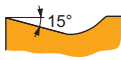

TN TR-S NN internal, left and right-handed design, for machining Metric and Unified threads, and continuous cuts.

TN 22NN600TR:T8030	●	–	160	95	150	480	40	–	6.00	–	11.0	1.9
TN 22NN700TR:T8030	●	–	160	95	150	480	40	–	7.00	–	11.0	2.3

TN 60°-S PP EXT



	IC (mm)	L (mm)	S (mm)
22	12.700	22.00	4.60

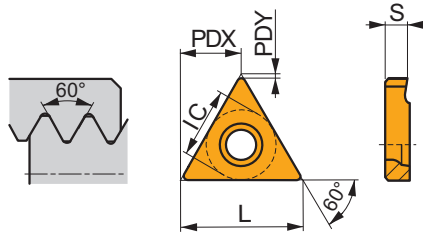

Suitability and starting values for cutting speed (vc). Refer to our Machining Calculator app for further calculations.

Product	RE (mm)	P	M	K	N	S	H	TPN (mm)	TPX (mm)	TPIN	TPIX	PDX (mm)	PDY (mm)
		vc (m/min)	vc (m/min)	vc (m/min)	vc (m/min)	vc (m/min)	vc (m/min)						

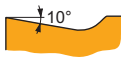
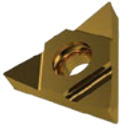

TN M60-S PP EN external, left and right-handed design, for machining Metric and Unified threads, and continuous cuts.

TN 22EN350-500M:T8030	●	–	160	95	150	480	40	–	3.50	5.00	5	7	11.0	0.5
TN 22EN550-800M:T8030	●	–	160	95	150	480	40	–	5.50	8.00	3	4.5	11.0	0.8

TN 60°-S PP INT



	IC (mm)	L (mm)	S (mm)
22	12.700	22.00	4.60

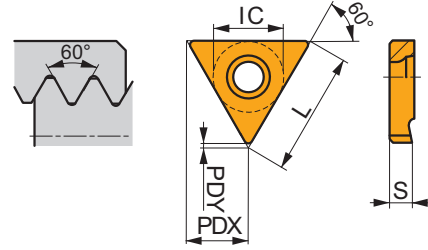

Suitability and starting values for cutting speed (vc). Refer to our Machining Calculator app for further calculations.

Product	RE (mm)	P	M	K	N	S	H	TPN	TPX	TPIN	TPIX	PDX	PDY
		vc (m/min)	vc (m/min)	vc (m/min)	vc (m/min)	vc (m/min)	vc (m/min)						

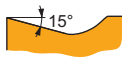

TN M60-S PP NN internal, left and right-handed design, for machining Metric and Unified threads, and continuous cuts.

TN 22NN350-500M:T8030	●	–	160	95	150	480	40	–	3.50	5.00	5	7	11.0	0.2
TN 22NN550-800M:T8030	●	–	160	95	150	480	40	–	5.50	8.00	3	4.5	11.0	0.5

TN TR EXT



	IC (mm)	L (mm)	S (mm)
16	9.525	16.50	3.47
22	12.700	22.00	4.71

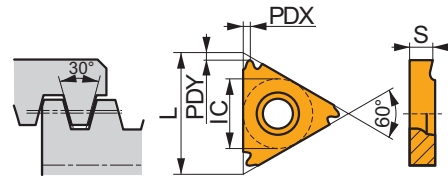

Suitability and starting values for cutting speed (vc). Refer to our Machining Calculator app for further calculations.

Product	RE (mm)	P	M	K	N	S	H	TP	TPI	PDX	PDY
		vc (m/min)	vc (m/min)	vc (m/min)	vc (m/min)	vc (m/min)	vc (m/min)				

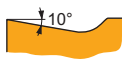

TN TR ER external, right-handed design, for machining Trapezoidal threads, and continuous cuts.

TN 16ER150TR:T8030	●	–	160	95	150	480	40	–	1.50	–	0.8	0.9
TN 16ER200TR:T8030	●	–	160	95	150	480	40	–	2.00	–	1.5	1.3
TN 16ER300TR:T8030	●	–	160	95	150	480	40	–	3.00	–	1.6	1.3
TN 22ER400TR:T8030	●	–	160	95	150	480	40	–	4.00	–	2.2	1.8
TN 22ER500TR:T8030	●	–	160	95	150	480	40	–	5.00	–	2.2	1.8

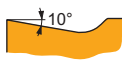

TN TR EL external, left-handed design, for machining Trapezoidal threads, and continuous cuts.

TN 16EL300TR:T8030	●	–	160	95	150	480	40	–	3.00	–	1.6	1.3
TN 22EL400TR:T8030	●	–	160	95	150	480	40	–	4.00	–	2.2	1.8
TN 22EL500TR:T8030	●	–	160	95	150	480	40	–	5.00	–	2.2	1.8

TN TR INT



	IC (mm)	L (mm)	S (mm)
16	9.525	16.50	3.47
22	12.700	22.00	4.71

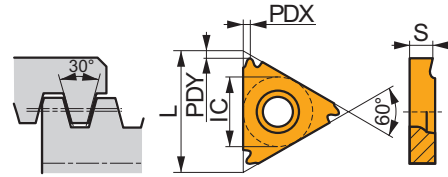

Suitability and starting values for cutting speed (vc). Refer to our Machining Calculator app for further calculations.

Product		RE (mm)	P	M	K	N	S	H	TP	TPI	PDX	PDY
			vc (m/min)	vc (m/min)	vc (m/min)	vc (m/min)	vc (m/min)	vc (m/min)				

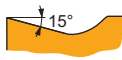

TN TR NR internal, right-handed design, for machining Trapezoidal threads, and continuous cuts.

TN 16NR150TR:T8030	●	–	160	95	150	480	40	–	1.50	–	0.8	0.9
TN 16NR200TR:T8030	●	–	160	95	150	480	40	–	2.00	–	1.5	1.3
TN 16NR300TR:T8030	●	–	160	95	150	480	40	–	3.00	–	1.6	1.3
TN 22NR400TR:T8030	●	–	160	95	150	480	40	–	4.00	–	2.2	1.8
TN 22NR500TR:T8030	●	–	160	95	150	480	40	–	5.00	–	2.2	1.8

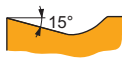

TN TR NL internal, left-handed design, for machining Trapezoidal threads, and continuous cuts.

TN 16NL300TR:T8030	●	–	160	95	150	480	40	–	3.00	–	1.6	1.3
---------------------------	---	---	-----	----	-----	-----	----	---	------	---	-----	-----

TN ACME EXT



	IC (mm)	L (mm)	S (mm)
16	9.525	16.50	3.47
22	12.700	22.00	4.71

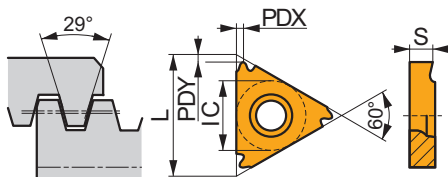

Suitability and starting values for cutting speed (vc). Refer to our Machining Calculator app for further calculations.

Product		RE (mm)	P	M	K	N	S	H	TP	TPI	PDX	PDY
			vc (m/min)	vc (m/min)	vc (m/min)	vc (m/min)	vc (m/min)					



TN ACME ER external, right-handed design, for machining ACME threads, and continuous cuts.

TN 16ER080ACME:T8030	●	–	160	95	150	480	40	–	–	8.0	1.5	1.3
TN 22ER060ACME:T8030	●	–	160	95	150	480	40	–	–	6.0	2.5	2.0
TN 22ER050ACME:T8030	●	–	160	95	150	480	40	–	–	5.0	2.3	2.0

TN ACME INT



	IC (mm)	L (mm)	S (mm)
22	12.700	22.00	4.71

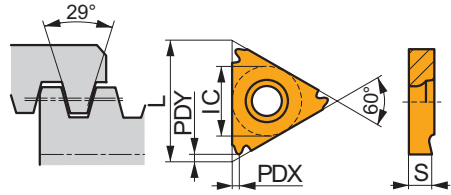

Suitability and starting values for cutting speed (vc). Refer to our Machining Calculator app for further calculations.

Product	RE (mm)	P	M	K	N	S	H	TP (mm)	TPI	PDX (mm)	PDY (mm)
		vc (m/min)	vc (m/min)	vc (m/min)	vc (m/min)	vc (m/min)	vc (m/min)				

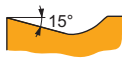

TN ACME NR internal, right-handed design, for machining ACME threads, and continuous cuts.

TN 22NR060ACME:T8030	●	-	■ 160	■ 95	■ 150	■ 480	■ 40	-	-	6.0	2.5	2.0
----------------------	---	---	-------	------	-------	-------	------	---	---	-----	-----	-----

TN STACME INT



	IC (mm)	L (mm)	S (mm)
16	9.525	16.50	3.47

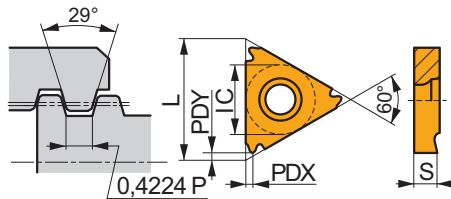

Suitability and starting values for cutting speed (vc). Refer to our Machining Calculator app for further calculations.

Product	RE (mm)	P	M	K	N	S	H	TP (mm)	TPI	PDX (mm)	PDY (mm)
		vc (m/min)	vc (m/min)	vc (m/min)	vc (m/min)	vc (m/min)	vc (m/min)				



TN STACME NR internal, right-handed, design for machining Stub ACME threads, and continuous cuts.

TN 16NR060STACME:T8030 ¹⁾	●	-	■ 160	■ 95	■ 150	■ 480	■ 40	-	-	6.0	1.3	1.3
--------------------------------------	---	---	-------	------	-------	-------	------	---	---	-----	-----	-----

¹⁾ Toolholders have to be modified.

TN BSPT EXT



	IC (mm)	L (mm)	S (mm)
16	9.525	16.50	3.47

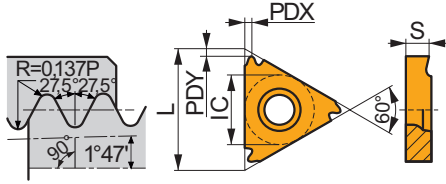

Suitability and starting values for cutting speed (vc). Refer to our Machining Calculator app for further calculations.

Product	RE (mm)	P	M	K	N	S	H	TP (mm)	TPI	PDX (mm)	PDY (mm)
		vc (m/min)	vc (m/min)	vc (m/min)	vc (m/min)	vc (m/min)	vc (m/min)				

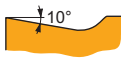

TN BSPT ER external, right-handed design, for machining BSPT threads, and continuous cuts.

TN 16ER190BSPT:T8030	●	–	160	95	150	480	40	–	–	19.0	1.5	1.2
TN 16ER140BSPT:T8030	●	–	160	95	150	480	40	–	–	14.0	1.5	1.2
TN 16ER110BSPT:T8030	●	–	160	95	150	480	40	–	–	11.0	1.5	1.2

TN BSPT INT



	IC (mm)	L (mm)	S (mm)
16	9.525	16.50	3.47

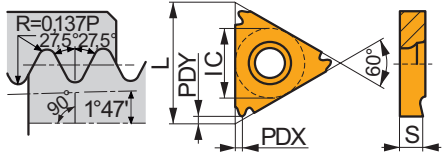

Suitability and starting values for cutting speed (vc). Refer to our Machining Calculator app for further calculations.

Product	RE (mm)	P	M	K	N	S	H	TP (mm)	TPI	PDX (mm)	PDY (mm)
		vc (m/min)	vc (m/min)	vc (m/min)	vc (m/min)	vc (m/min)	vc (m/min)				

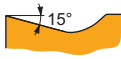
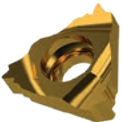

TN BSPT NR internal, right-handed design, for machining BSPT threads, and continuous cuts.

TN 16NR140BSPT:T8030	●	–	160	95	150	480	40	–	–	14.0	1.5	1.2
TN 16NR110BSPT:T8030	●	–	160	95	150	480	40	–	–	11.0	1.5	1.2

TN RD EXT



	IC (mm)	L (mm)	S (mm)
16	9.525	16.50	3.47
22	12.700	22.00	4.71

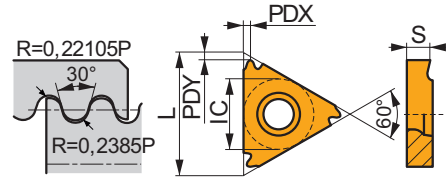

Suitability and starting values for cutting speed (vc). Refer to our Machining Calculator app for further calculations.

Product	RE (mm)	P	M	K	N	S	H	TP (mm)	TPI	PDX (mm)	PDY (mm)
		vc (m/min)	vc (m/min)	vc (m/min)	vc (m/min)	vc (m/min)	vc (m/min)				

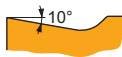
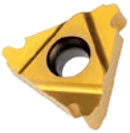

TN RD ER external, right-handed design, for machining Metric Round threads, and continuous cuts.

TN 16ER080RD:T8030	●	–	160	95	150	480	40	–	–	8.0	1.5	1.2
TN 16ER060RD:T8030 ¹⁾	●	–	160	95	150	480	40	–	–	6.0	1.5	1.2
TN 22ER060RD:T8030	●	–	160	95	150	480	40	–	–	6.0	2.5	1.8

¹⁾ Toolholders have to be modified.

TN RD INT



	IC (mm)	L (mm)	S (mm)
16	9.525	16.50	3.47
22	12.700	22.00	4.71

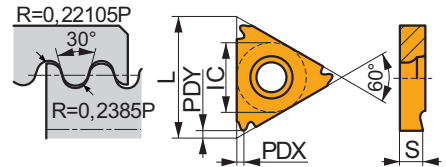

Suitability and starting values for cutting speed (vc). Refer to our Machining Calculator app for further calculations.

Product	RE (mm)	P	M	K	N	S	H	TP (mm)	TPI	PDX (mm)	PDY (mm)
		vc (m/min)	vc (m/min)	vc (m/min)	vc (m/min)	vc (m/min)	vc (m/min)				

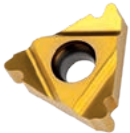

TN RD NR internal, right-handed design, for machining Metric Round threads, and continuous cuts.

TN 16NR080RD:T8030	●	–	160	95	150	480	40	–	–	8.0	1.5	1.2
TN 16NR060RD:T8030 ¹⁾	●	–	160	95	150	480	40	–	–	6.0	1.5	1.2
TN 22NR060RD:T8030	●	–	160	95	150	480	40	–	–	6.0	2.5	1.8

¹⁾ Toolholders have to be modified.

TN API RD EXT



	IC (mm)	L (mm)	S (mm)
16	9.525	16.50	3.47

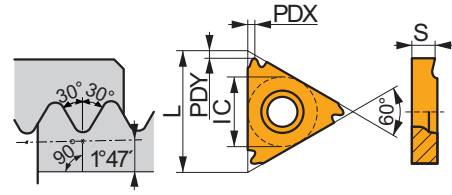

Suitability and starting values for cutting speed (vc). Refer to our Machining Calculator app for further calculations.

Product	RE (mm)	P	M	K	N	S	H	TP (mm)	TPI	PDX (mm)	PDY (mm)
		vc (m/min)	vc (m/min)	vc (m/min)	vc (m/min)	vc (m/min)	vc (m/min)				

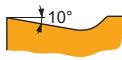
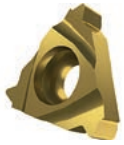

TN API ER external, right-handed design, for machining API threads, and continuous cuts.

TN 16ER100API-RD01:T8030	●	–	160	95	150	480	40	–	–	10.0	1.5	1.2
TN 16ER080API-RD01:T8030	●	–	160	95	150	480	40	–	–	8.0	1.5	1.2

TN API RD INT



	IC (mm)	L (mm)	S (mm)
16	9.525	16.50	3.47

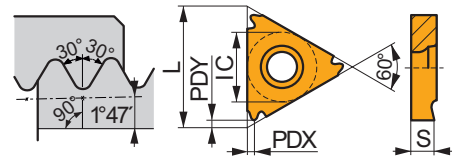

Suitability and starting values for cutting speed (vc). Refer to our Machining Calculator app for further calculations.

Product	RE (mm)	P	M	K	N	S	H	TP (mm)	TPI	PDX (mm)	PDY (mm)
		vc (m/min)	vc (m/min)	vc (m/min)	vc (m/min)	vc (m/min)	vc (m/min)				

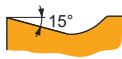
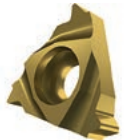

TN API NR internal, right-handed design, for machining API threads, and continuous cuts.

TN 16NR100API-RD01:T8030	●	–	160	95	150	480	40	–	–	10.0	1.5	1.2
TN 16NR080API-RD01:T8030	●	–	160	95	150	480	40	–	–	8.0	1.5	1.2

TN M EXT



	IC (mm)	L (mm)	S (mm)
16	9.525	16.50	3.47

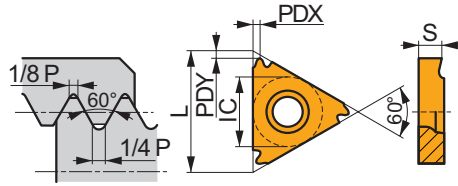

Suitability and starting values for cutting speed (vc). Refer to our Machining Calculator app for further calculations.

Product	RE (mm)	P	M	K	N	S	H	TP (mm)	TPI	PDX (mm)	PDY (mm)
		vc (m/min)	vc (m/min)	vc (m/min)	vc (m/min)	vc (m/min)	vc (m/min)				

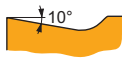
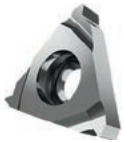

TN M-AL ER external, right-handed design, for machining ISO Metric threads, and continuous cuts.

TN 16ER100M-AL:HF7	●	-	-	✓	95	-	■	480	-	-	1.00	-	0.8	0.8
TN 16ER125M-AL:HF7	●	-	-	✓	95	-	■	480	-	-	1.25	-	0.8	0.8
TN 16ER150M-AL:HF7	●	-	-	✓	95	-	■	480	-	-	1.50	-	0.8	0.8
TN 16ER200M-AL:HF7	●	-	-	✓	95	-	■	480	-	-	2.00	-	1.5	1.2

TN M INT



	IC (mm)	L (mm)	S (mm)
16	9.525	16.50	3.47

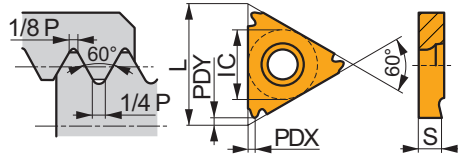

Suitability and starting values for cutting speed (vc). Refer to our Machining Calculator app for further calculations.

Product	RE (mm)	P	M	K	N	S	H	TP (mm)	TPI	PDX (mm)	PDY (mm)
		vc (m/min)	vc (m/min)	vc (m/min)	vc (m/min)	vc (m/min)	vc (m/min)				

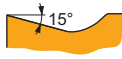
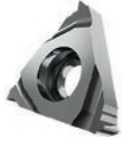

TN M-AL NR internal, right-handed design, for machining ISO Metric threads, and continuous cuts.

TN 16NR150M-AL:HF7	●	-	-	✓	95	-	■	480	-	-	1.50	-	0.8	0.8
TN 16NR200M-AL:HF7	●	-	-	✓	95	-	■	480	-	-	2.00	-	1.5	1.2

SE(RL)

P
M
K
N
S
H

PRAMET

S



External Threading Holder for TN 16, 22 inserts clamped by screw

Right/Left hand tool holder for external threading with TN or ER/EL inserts clamped by screw. Suited for threading in metric or inch profile. Body treated for longer tool life.

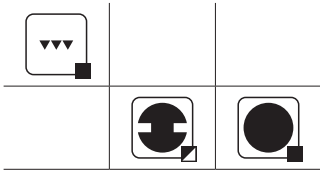
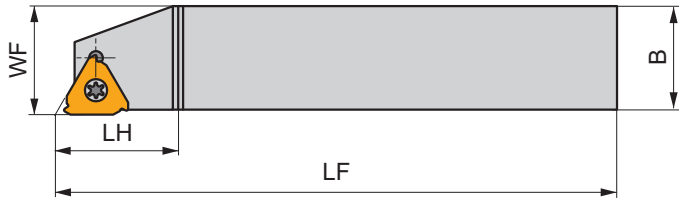
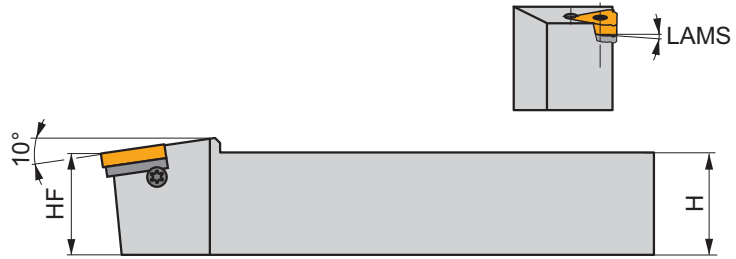
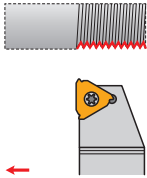

Product	H	HF	B	WF	LF	HF	LAMS		
	(mm)	(mm)	(mm)	(mm)	(mm)	(mm)	(°)		
R SER 2020 K 16	20	20	20	20	125	22.5	–	GI068	Z12
SER 2525 M 16	25	25	25	25	150	24.0	–	GI068	Z12
SER 3225 P 16	32	32	25	25	170	24.5	–	GI068	Z12
SER 2525 M 22-A	25	25	25	25	150	25.5	–	GI071	Z13
SER 3225 P 22-A	32	32	25	25	170	25.5	–	GI071	Z13
L SEL 2020 K 16	20	20	20	20	125	22.5	–	GI068	Z12
SEL 2525 M 16	25	25	25	25	150	24.0	–	GI068	Z12
SEL 2525 M 22-A	25	25	25	25	150	25.5	–	GI071	Z13

GI068	TN 16ER..	TN 16EL..
GI071	TN 22ER..	TN 22EL..

Z12	US 3512A-T15P	3.0	M 3.5	12.7	–	HS 0304	FLAG T15P	HXK 2.5	Page xx
Z13	US 4514A-T20	5.0	M 4.5	14	SP 0405	–	FLAG T20	–	Page xx

SE(RL)-S

P
M
K
N
S
H

PRAMET

S



External Threading Holder for TN 22 EN inserts clamped by screw

Right/Left hand tool holder for external threading with TN or ER/EL inserts clamped by screw. Suited for threading in metric or inch profile. Body treated for longer tool life.

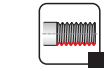
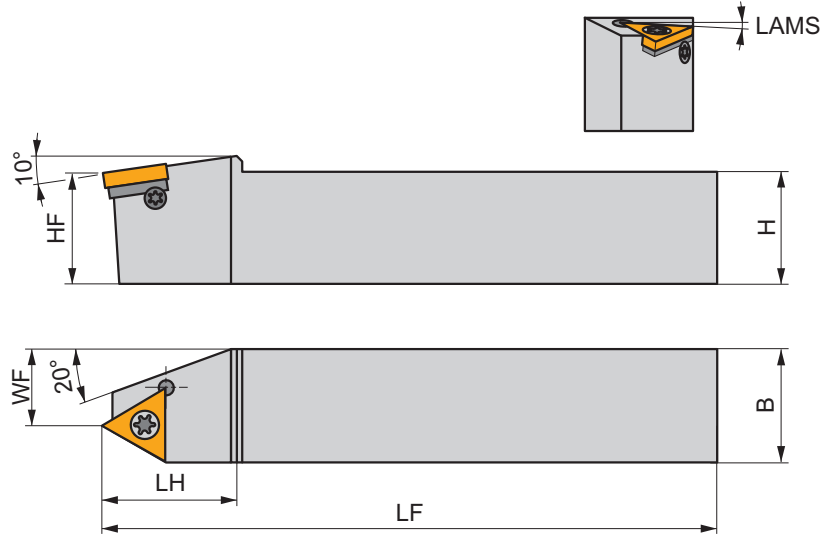
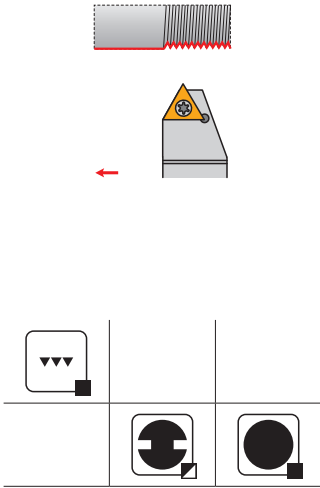

Product	H	HF	B	WF	LF	LH	LAMS		
	(mm)	(mm)	(mm)	(mm)	(mm)	(mm)	(°)		
R SER-S 2525 M 22-A	25	25	25	14	150	30.0	-	G1086	Z15
SER-S 3225 P 22-A	32	32	25	14	170	30.0	-	G1086	Z15
L SEL-S 2525 M 22-A	25	25	25	14	150	30.0	-	G1086	Z15

G1086	TN 22EN..

Z15	US 4514A-T20	5.0	M 4.5	14	SP 0405	FLAG T20	Page xx

SI(RL)



PRAMET

S







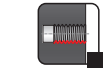
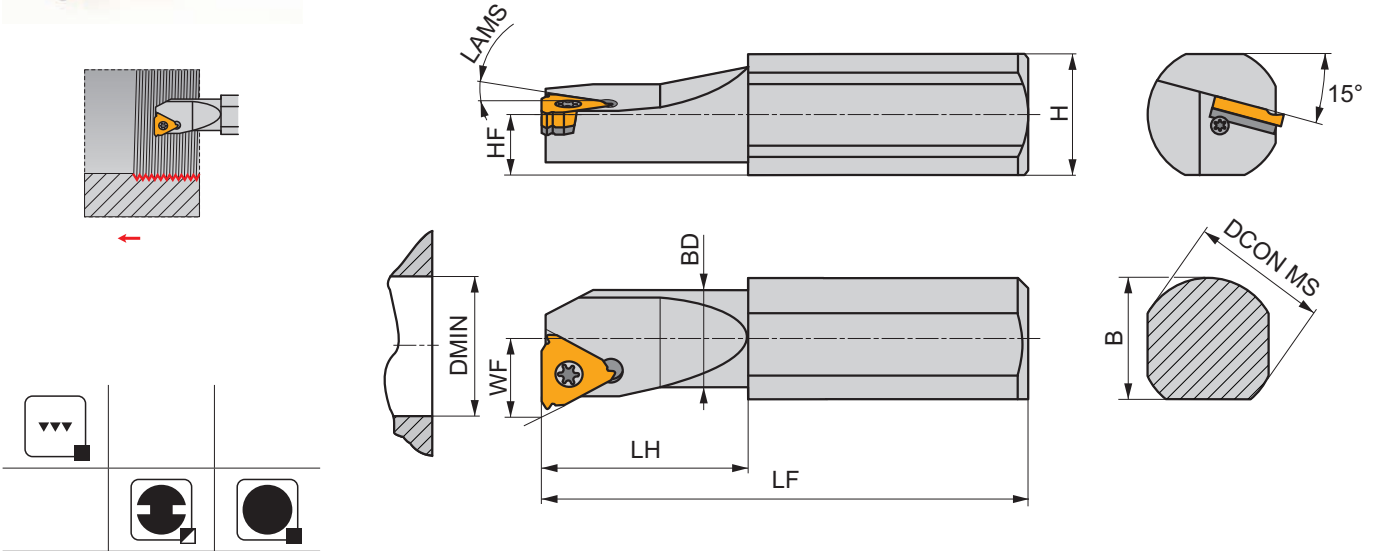







Internal Threading Holder for TN 11, 16, 22 inserts clamped by screw

Right/Left hand boring bar for internal threading with TN NR/NL inserts clamped by screw. Suited for threading in metric or inch profile. Body treated for longer tool life.



Product	B	DCON MS	DMIN	BD	WF	H	HF	LF	LH	LAMS		
	(mm)	(mm)	(mm)	(mm)	(mm)	(mm)	(mm)	(mm)	(mm)	(°)		
R SIR 0010 K 11-0	14.5	16	13	10	7.45	14	7	125	25.0	0	–	GI085 Z11
SIR 0010 K 11-1	14.5	16	13	10	7.45	14	7	125	25.0	1	–	GI085 Z11
SIR 0013 M 11-0	14.5	16	16	13	9	14	7	150	32.0	0	–	GI085 Z11
SIR 0013 M 11-1	14.5	16	16	13	9	14	7	150	32.0	1	–	GI085 Z11
SIR 1416 N 16-0	14	16	22	17	11.4	14.5	7.25	160	–	0	–	GI022 Z9
SIR 1416 N 16-1	14	16	22	17	11.4	14.5	7.25	160	–	1	–	GI022 Z9
SIR 1416 N 16-2	14	16	16.5	15.5	10.6	14.5	7.25	160	40.0	2	✓	GI022 Z10
SIR 1820 P 16	18.5	20	27	21	13.85	18	9	170	–	–	–	GI022 Z12
SIR 2325 Q 16	23.5	25	29	26	16.55	23	11.5	180	–	–	–	GI022 Z12
SIR 2532 S 16	30	32	36	32	19.75	25	12.5	250	–	–	–	GI022 Z12
SIR 2532 S 22-2	30	32	25	25	16.65	25	12.5	250	80.0	2	✓	GI076 Z14
SIR 2532 S 22-A	30	32	36	32	21.65	25	12.5	250	–	–	–	GI076 Z13
SIR 3240 T 22-A	38	40	48	40	25.85	32	16	300	–	–	–	GI076 Z13
L SIL 0010 K 11-0	14.5	16	13	10	7.45	14	7	125	25.0	0	–	GI085 Z11
SIL 0010 K 11-1	14.5	16	13	10	7.45	14	7	125	25.0	1	–	GI085 Z11
SIL 0013 M 11-1	14.5	16	16	13	9	14	7	150	32.0	1	–	GI085 Z11
SIL 1416 N 16-0	14	16	22	17	11.4	14.5	7.25	160	–	0	–	GI022 Z9
SIL 1416 N 16-1	14	16	22	17	11.4	14.5	7.25	160	–	1	–	GI022 Z9
SIL 1416 N 16-2	14	16	16.5	15.5	10.6	14.5	7.25	160	40.0	2	✓	GI022 Z10
SIL 1820 P 16	18.5	20	24	21	13.85	18	9	170	–	–	–	GI022 Z12
SIL 2325 Q 16	23.5	25	29	26	16.55	23	11.5	180	–	–	–	GI022 Z12
SIL 2532 S 16	30	32	36	32	19.75	25	12.5	250	–	–	–	GI022 Z12
SIL 2532 S 22-2	30	32	25	25	16.65	25	12.5	250	80.0	2	✓	GI076 Z14

		
GI076	TN 22NR..	TN 22NL..
GI085	TN 11NR..	TN 11NL..

									
Z10	US 3510A-T15P	3.0	M 3.5	10.6	-	-	FLAG T15P	-	-
Z11	US 2506-T07P	0.9	M 2.5	6.3	-	-	FLAG T07P	-	-
Z12	US 3512A-T15P	3.0	M 3.5	12.7	-	HS 0304	FLAG T15P	HXK 2.5	Page xx
Z13	US 4514A-T20	5.0	M 4.5	14	SP 0405	-	FLAG T20	-	Page xx
Z14	US 4514A-T20	5.0	M 4.5	14	-	-	FLAG T20	-	-
Z9	US 3510A-T15P	3.0	M 3.5	10.6	-	-	FLAG T15P	-	P-16

SI(RL)-S

P
M
K
N
S
H

PRAMET

S



Internal Threading Holder for TN 22 NN inserts clamped by screw

Right/Left hand boring bar for internal threading with TN NN neutral inserts clamped by screw. Suited for threading in metric or inch profile. Body treated for longer tool life.

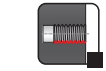
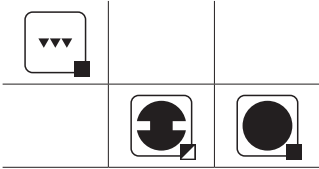
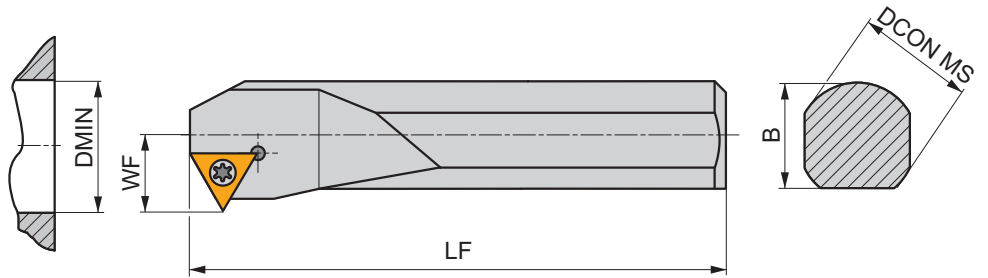
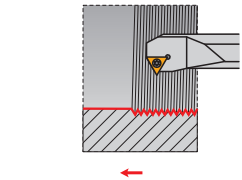

Product	B	DCON MS	DMIN	WF	H	HF	LF	LAMS		
	(mm)	(mm)	(mm)	(mm)	(mm)	(mm)	(mm)	(°)		
R SIR-S 2532 S 22-A	30	32	39	22.3	25	12.5	250	-	G107	Z15
SIR-S 3240 T 22-A	38	40	48	27	32	16	300	-	G107	Z15

	G107		TN 22NN..
--	------	--	-----------

	Z15		US 4514A-T20		5.0		M 4.5		14		SP 0405		FLAG T20		Page xx
--	-----	--	--------------	--	-----	--	-------	--	----	--	---------	--	----------	--	---------



BROACHING & TOOL BITS

PHZ



PRAMET

S



Int. Broaching Tool Holder for Small Diameters with Single-Sided HZ Inserts
 Internal tool holder for broaching up to 12 mm width. Body treated for longer tool life.

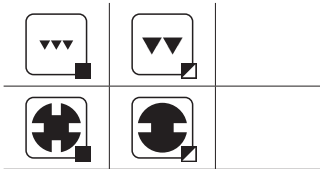
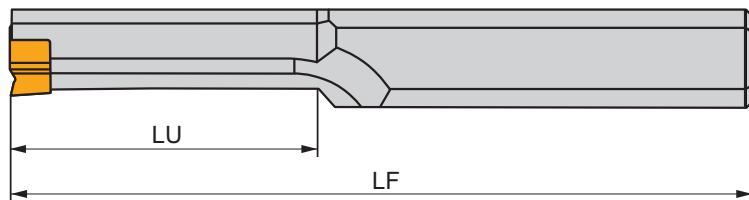
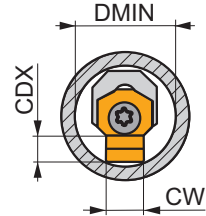
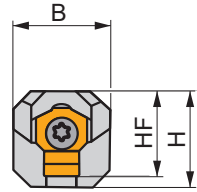
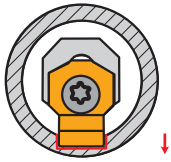

Product	H	HF	B	OAL	LU	CW	DMIN	CDX	kg	G1239	SH21
	(mm)	(mm)	(mm)	(mm)	(mm)	(mm)	(mm)	(mm)			
N PHZ 90 1104-06	11.3	9	8.5	160	35	3.00	9.5	1.6	0.14	G1239	SH21
PHZ 90 1107-06	11.3	10	7	200	60	—	—	—	0.19	G1240	SH21
PHZ 90 1111-06	11.3	12	—	200	60	—	—	—	0.21	G1240	SH21
PHZ 1512-10	15.5	16.2	—	220	—	—	—	—	0.33	G1224	SH22
PHZ 2014-13	20.6	21.5	—	250	—	—	—	—	0.58	G1225	SH23

G1224	HZ 1006-60	HZ 1006-80
G1225	HZ 1309-100	HZ 1309-120
G1239	HZ90 0604-30	—
G1240	HZ90 0604-40	HZ90 0604-50

SH21	DVF 3593	0.8	M 2.5	10	TX207PLUS
SH22	DVF 2260	3.6	M 4	15	TX215PLUS
SH23	5513 020-14	8.5	M 6	18	TX225PLUS

PHZ-2



PRAMET

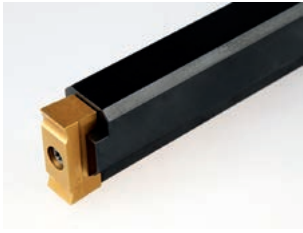

Int. Broaching Tool Holder for Larger Diameters with Double-Sided HZ Inserts
 Internal tool holder for broaching up to 20 mm width. Body treated for longer tool life.

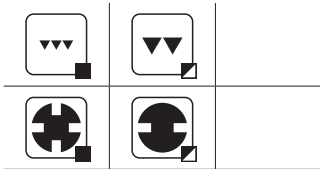
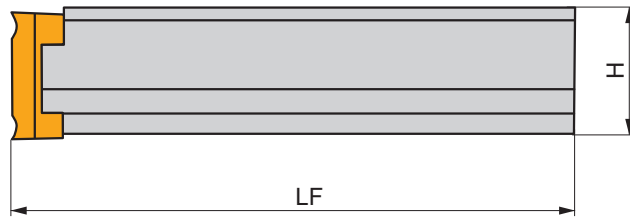
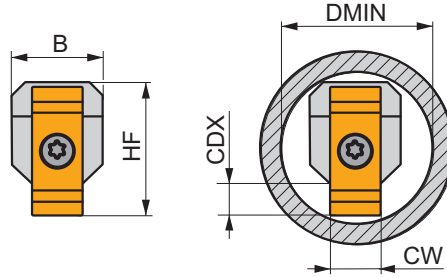
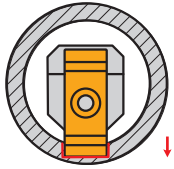

Product	H	HF	B	OAL	CW	DMIN	CDX	kg		
	(mm)	(mm)	(mm)	(mm)	(mm)	(mm)	(mm)			
N PHZ/2 3625-14	36	37.5	25	300	–	44	–	1.84	G1235	SH23
PHZ/2 4832-18	48	50	32	400	–	58	–	2.00	G1241	SH24

G1235	HZ/2 14-14	HZ/2 16-16
G1241	HZ/2 18-18	HZ/2 20-20

SH23	5513 020-14	8.5	M 6	18	TX225PLUS
SH24	5513 021-03	13.0	M 8	22	DMN 3124

HZ



	CW	INSL	APMX	S	S1
	(mm)	(mm)	(mm)	(mm)	(mm)
0604-30	3.00	7.5	1.60	4.66	4.76
0604-40	4.00	8.0	2.50	4.66	4.76
0604-50	5.00	8.0	3.00	4.66	4.76
1006-60	6.00	13.5	4.20	6.25	6.35
1006-80	8.00	13.5	5.20	6.25	6.35
1309-100	10.00	18.5	6.20	9.40	9.53
1309-120	12.00	18.5	7.20	9.40	9.53

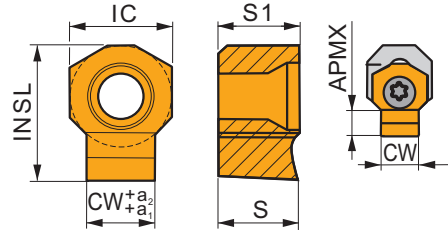

Suitability and starting values for cutting speed (vc) and feed (fz). Refer to our Machining Calculator app for further calculations.

Product	Interrupted/ Continuous cut	RE (mm)	P		M		K		N		S		H		CW (mm)	CWTOLL (mm)	CWTOLU (mm)
			vc (m/min)	f (mm/rev)	vc (m/min)	f (mm/rev)	vc (m/min)	f (mm/rev)	vc (m/min)	f (mm/rev)	vc (m/min)	f (mm/rev)	vc (m/min)	f (mm/rev)			

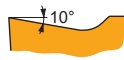

Positive geometry for broaching (one cutting edge).

HZ 1006-60 C11:333TN	*	-	50	0.10	30	0.09	45	0.10	-	-	-	-	6.00	0.07	0.14
HZ 1006-60 D10:333TN	*	-	50	0.10	30	0.09	45	0.10	-	-	-	-	6.00	0.03	0.08
HZ 1006-60 H7:333TN	*	-	50	0.10	30	0.09	45	0.10	-	-	-	-	6.00	0.00	0.01
HZ 1006-60 P9:333TN	*	-	50	0.10	30	0.09	45	0.10	-	-	-	-	6.00	-0.04	-0.01
HZ 1006-80 C11:333TN	*	-	50	0.10	30	0.09	45	0.10	-	-	-	-	8.00	0.08	0.17
HZ 1006-80 D10:333TN	*	-	50	0.10	30	0.09	45	0.10	-	-	-	-	8.00	0.04	0.10
HZ 1006-80 H7:333TN	*	-	50	0.10	30	0.09	45	0.10	-	-	-	-	8.00	0.00	0.01
HZ 1006-80 P9:333TN	*	-	50	0.10	30	0.09	45	0.10	-	-	-	-	8.00	-0.05	-0.01
HZ 1309-100 C11:333TN	*	-	50	0.10	30	0.09	45	0.10	-	-	-	-	10.00	0.08	0.17
HZ 1309-100 D10:333TN	*	-	50	0.10	30	0.09	45	0.10	-	-	-	-	10.00	0.04	0.10
HZ 1309-100 H7:333TN	*	-	50	0.10	30	0.09	45	0.10	-	-	-	-	10.00	0.00	0.01
HZ 1309-100 P9:333TN	*	-	50	0.10	30	0.09	45	0.10	-	-	-	-	10.00	-0.05	-0.01
HZ 1309-120 C11:333TN	*	-	50	0.10	30	0.09	45	0.10	-	-	-	-	12.00	0.10	0.20
HZ 1309-120 D10:333TN	*	-	50	0.10	30	0.09	45	0.10	-	-	-	-	12.00	0.05	0.12
HZ 1309-120 H7:333TN	*	-	50	0.10	30	0.09	45	0.10	-	-	-	-	12.00	0.00	0.02
HZ 1309-120 P9:333TN	*	-	50	0.10	30	0.09	45	0.10	-	-	-	-	12.00	-0.06	-0.02
HZ90 0604-30 C11:333TN	*	-	50	0.10	30	0.09	45	0.10	-	-	-	-	3.00	0.06	0.12
HZ90 0604-30 D10:333TN	*	-	50	0.10	30	0.09	45	0.10	-	-	-	-	3.00	0.02	0.06
HZ90 0604-30 H7:333TN	*	-	50	0.10	30	0.09	45	0.10	-	-	-	-	3.00	0.00	0.01
HZ90 0604-30 P9:333TN	*	-	50	0.10	30	0.09	45	0.10	-	-	-	-	3.00	-0.03	-0.01
HZ90 0604-40 C11:333TN	*	-	50	0.10	30	0.09	45	0.10	-	-	-	-	4.00	0.07	0.14
HZ90 0604-40 D10:333TN	*	-	50	0.10	30	0.09	45	0.10	-	-	-	-	4.00	0.03	0.08
HZ90 0604-40 H7:333TN	*	-	50	0.10	30	0.09	45	0.10	-	-	-	-	4.00	0.00	0.01
HZ90 0604-40 P9:333TN	*	-	50	0.10	30	0.09	45	0.10	-	-	-	-	4.00	-0.04	-0.01
HZ90 0604-50 C11:333TN	*	-	50	0.10	30	0.09	45	0.10	-	-	-	-	5.00	0.07	0.14
HZ90 0604-50 D10:333TN	*	-	50	0.10	30	0.09	45	0.10	-	-	-	-	5.00	0.03	0.08
HZ90 0604-50 H7:333TN	*	-	50	0.10	30	0.09	45	0.10	-	-	-	-	5.00	0.00	0.01
HZ90 0604-50 P9:333TN	*	-	50	0.10	30	0.09	45	0.10	-	-	-	-	5.00	-0.04	-0.01

HZ-2



	INSL (mm)	APMX (mm)	S (mm)	S1 (mm)	CW (mm)
14-14	36.0	8.00	13.90	14.00	14.00
16-16	36.0	9.00	13.90	14.00	16.00
18-18	45.0	12.00	15.90	16.00	18.00
20-20	45.0	13.00	15.90	16.00	20.00

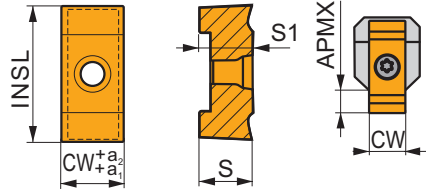

Suitability and starting values for cutting speed (vc) and feed (fz). Refer to our Machining Calculator app for further calculations.

Product	Intermittent/ Continuous cut	RE (mm)	P		M		K		N		S		H		CW (mm)	CWTOLL (mm)	CWTOLU (mm)
			vc (m/min)	f (mm/rev)	vc (m/min)	f (mm/rev)	vc (m/min)	f (mm/rev)	vc (m/min)	f (mm/rev)	vc (m/min)	f (mm/rev)	vc (m/min)	f (mm/rev)			



Positive geometry for broaching (two cutting edges).

HZ/2 14-14 C11:333TN	✳	-	50	0.10	30	0.09	45	0.10	-	-	-	-	-	-	14.00	0.10	0.20
HZ/2 14-14 H7:333TN	✳	-	50	0.10	30	0.09	45	0.10	-	-	-	-	-	-	14.00	0.00	0.02
HZ/2 14-14 P9:333TN	✳	-	50	0.10	30	0.09	45	0.10	-	-	-	-	-	-	14.00	-0.06	-0.02
HZ/2 16-16 C11:333TN	✳	-	50	0.10	30	0.09	45	0.10	-	-	-	-	-	-	16.00	0.10	0.20
HZ/2 16-16 H7:333TN	✳	-	50	0.10	30	0.09	45	0.10	-	-	-	-	-	-	16.00	0.00	0.02
HZ/2 16-16 P9:333TN	✳	-	50	0.10	30	0.09	45	0.10	-	-	-	-	-	-	16.00	-0.06	-0.02
HZ/2 18-18 C11:333TN	✳	-	50	0.10	30	0.09	45	0.10	-	-	-	-	-	-	18.00	0.10	0.20
HZ/2 18-18 H7:333TN	✳	-	50	0.10	30	0.09	45	0.10	-	-	-	-	-	-	18.00	0.00	0.02
HZ/2 18-18 P9:333TN	✳	-	50	0.10	30	0.10	45	0.10	-	-	-	-	-	-	18.00	-0.06	-0.02
HZ/2 20-20 C11:333TN	✳	-	50	0.10	30	0.09	45	0.10	-	-	-	-	-	-	20.00	0.11	0.24
HZ/2 20-20 H7:333TN	✳	-	50	0.10	30	0.09	45	0.10	-	-	-	-	-	-	20.00	0.00	0.02
HZ/2 20-20 P9:333TN	✳	-	50	0.10	30	0.10	45	0.10	-	-	-	-	-	-	20.00	-0.07	-0.02

TOOL BITS F

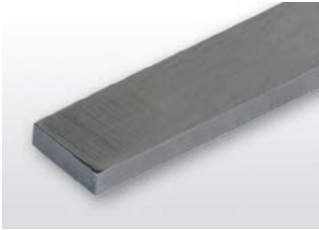

HSS-E Rectangular Tool bit

Ground rectangular tool bit according to DIN 4964 D standard. T2000S HSS-E bright steel with 10% Cobalt content in hardness 65-67 HRC.



HSS-E	DIN 4964D	Bright
h13		

Product	H (mm)	B (mm)	OAL (mm)
8X6X200:T2000S	8	6	200.0
10X2X200:T2000S	10	2	200.0
10X3X200:T2000S	10	3	200.0
10X4X200:T2000S	10	4	200.0
10X5X200:T2000S	10	5	200.0
10X6X200:T2000S	10	6	200.0
10X8X200:T2000S	10	8	200.0
12X3X200:T2000S	12	3	200.0
12X4X200:T2000S	12	4	200.0
12X6X200:T2000S	12	6	200.0
12X8X200:T2000S	12	8	200.0
15X3X200:T2000S	15	3	200.0
15X4X200:T2000S	15	4	200.0
15X5X200:T2000S	15	5	200.0
15X6X200:T2000S	15	6	200.0
15X8X200:T2000S	15	8	200.0
15X10X200:T2000S	15	10	200.0
16X8X200:T2000S	16	8	200.0
16X10X200:T2000S	16	10	200.0

Product	H (mm)	B (mm)	OAL (mm)
16X12X200:T2000S	16	12	200.0
20X3X200:T2000S	20	3	200.0
20X4X200:T2000S	20	4	200.0
20X5X200:T2000S	20	5	200.0
20X6X200:T2000S	20	6	200.0
20X8X200:T2000S	20	8	200.0
20X10X200:T2000S	20	10	200.0
20X12X200:T2000S	20	12	200.0
20X15X200:T2000S	20	15	200.0
25X5X200:T2000S	25	5	200.0
25X6X200:T2000S	25	6	200.0
25X10X200:T2000S	25	10	200.0
25X12X200:T2000S	25	12	200.0
30X4X200:T2000S	30	4	200.0
30X5X200:T2000S	30	5	200.0
30X10X200:T2000S	30	10	200.0
30X15X200:T2000S	30	15	200.0
30X20X200:T2000S	30	20	200.0

TOOL BITS R



HSS-E Round Tool bit

Ground round tool bit according to DIN 4964 A standard. T2000S HSS-E bright steel with 10% Cobalt content in hardness 65-67 HRC.

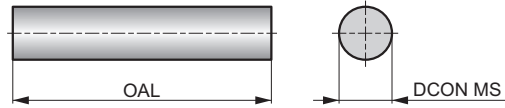

HSS-E	DIN 4964A	Bright
h9		

Product	DCON MS		OAL
	(mm)		(mm)
3X200 T:T2000S	3.00		200.0
4X200 T:T2000S	4.00		200.0
5X200 T:T2000S	5.00		200.0
6X200 T:T2000S	6.00		200.0
7X200 T:T2000S	7.00		200.0
8X200 T:T2000S	8.00		200.0
10X200 T:T2000S	10.00		200.0
12X200 T:T2000S	12.00		200.0
14X200 T:T2000S	14.00		200.0
16X200 T:T2000S	16.00		200.0
20X200 T:T2000S	20.00		200.0

TOOL BITS S

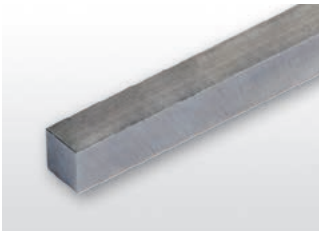

HSS-E Square Tool bit

Ground square tool bit according to DIN 4964 B standard. T2000S HSS-E bright steel with 10% Cobalt content in hardness 65-67 HRC.



HSS-E	DIN 4964B	Bright
+0 -0.1		

Product	H (mm)	B (mm)	OAL (mm)
4X4X200:T2000S	4	4	200.0
6X6X200:T2000S	6	6	200.0
8X8X200:T2000S	8	8	200.0
10X10X200:T2000S	10	10	200.0
12X12X200:T2000S	12	12	200.0
14X14X200:T2000S	14	14	200.0
15X15X200:T2000S	15	15	200.0
16X16X200:T2000S	16	16	200.0
20X20X200:T2000S	20	20	200.0
25X25X200:T2000S	25	25	200.0

TOOL BITS SA

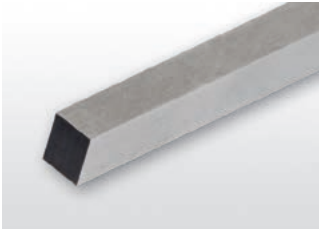

HSS-E Square Tool bit with Bevel

Ground square tool bit with beveled ends according to DIN 4964 B standard. T2000S HSS-E bright steel with 10% Cobalt content in hardness 65-67 HRC.

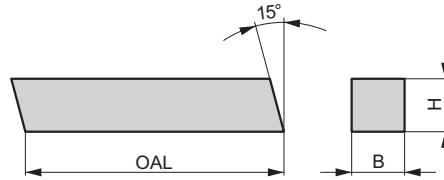

HSS-E	DIN 4964B	Bright
h13		

Product	H	B	OAL	H	B	OAL
	(mm)	(mm)	(mm)	(inch)	(inch)	(inch)
4X4X200A:T2000S	4	4	200.0	-	-	-
6X6X100A:T2000S	6	6	100.0	-	-	-
6X6X200A:T2000S	6	6	200.0	-	-	-
8X8X100A:T2000S	8	8	100.0	-	-	-
8X8X160A:T2000S	8	8	160.0	-	-	-
8X8X200A:T2000S	8	8	200.0	-	-	-
10X10X100A:T2000S	10	10	100.0	-	-	-
10X10X160A:T2000S	10	10	160.0	-	-	-
10X10X200A:T2000S	10	10	200.0	-	-	-
12X12X100A:T2000S	12	12	100.0	-	-	-
12X12X200A:T2000S	12	12	200.0	-	-	-
14X14X200A:T2000S	14	14	200.0	-	-	-
15X15X200A:T2000S	15	15	200.0	-	-	-
16X16X200A:T2000S	16	16	200.0	-	-	-
20X20X200A:T2000S	20	20	200.0	-	-	-
25X25X200A:T2000S	25	25	200.0	-	-	-
3/16X3/16X2.1/2A:T2000S	-	-	-	3/16	3/16	2.500
1/4X1/4X2.1/2A:T2000S	-	-	-	1/4	1/4	2.500
1/4X1/4X4A:T2000S	-	-	-	1/4	1/4	4.000
5/16X5/16X2.1/2A:T2000S	-	-	-	5/16	5/16	2.500
5/16X5/16X4A:T2000S	-	-	-	5/16	5/16	4.000
3/8X3/8X3A:T2000S	-	-	-	3/8	3/8	3.000
3/8X3/8X4A:T2000S	-	-	-	3/8	3/8	4.000
3/8X3/8X6A:T2000S	-	-	-	3/8	3/8	6.000
1/2X1/2X4A:T2000S	-	-	-	1/2	1/2	4.000
1/2X1/2X6A:T2000S	-	-	-	1/2	1/2	6.000
5/8X5/8X6A:T2000S	-	-	-	5/8	5/8	6.000



INSTRUCTIONS

TURNING INSERTS – PAGE OVERVIEW

SM

5

6

SM chip breaker is versatile and the first choice for medium machining of Steels and Super-alloys. It features slightly positive rake angle and stable, moderate T-land. It's also suitable for Stainless steels, Cast irons, and conditionally for Non-ferrous alloys and Hard materials.

10

1 CNMG

DNMG

SNMG

	IC (mm)	D1 (mm)	L (mm)	S (mm)
1204	12.700	5.16	12.90	4.76
1606	15.875	6.35	16.10	6.35
1906	19.050	7.94	19.30	6.35

	IC (mm)	D1 (mm)	L (mm)	S (mm)
1104	9.525	3.81	11.60	4.76
1504	12.700	5.16	15.50	4.76
1506	12.700	5.16	15.50	6.35

	IC (mm)	D1 (mm)	L (mm)	S (mm)
1204	12.700	5.16	12.70	4.76
1906	19.050	7.94	19.05	6.35

2

TNMG

VNMG

WNMG

	IC (mm)	D1 (mm)	L (mm)	S (mm)
1604	9.525	3.81	16.50	4.76

	IC (mm)	D1 (mm)	L (mm)	S (mm)
1604	9.525	3.81	16.60	4.76

	IC (mm)	D1 (mm)	L (mm)	S (mm)
0604	9.525	3.81	6.50	4.76

Suitability and starting values for cutting speed (vc), feed (f) and depth of cut (ap). Refer to our Machining Calculator app for further calculations.

Product	RE (mm)	P			M			K			N			S			H		
		vc (m/min)	f (mm/rev)	ap (mm)	vc (m/min)	f (mm/rev)	ap (mm)	vc (m/min)	f (mm/rev)	ap (mm)	vc (m/min)	f (mm/rev)	ap (mm)	vc (m/min)	f (mm/rev)	ap (mm)	vc (m/min)	f (mm/rev)	ap (mm)
4	0.4	155	0.20	2.0	110	0.18	2.0	125	0.20	2.0	465	0.24	2.0	45	0.18	1.6	30	0.13	0.3
7	0.4	180	0.20	2.0	140	0.18	2.0	–	–	–	–	–	55	0.18	1.6	–	–	–	
8	0.4	175	0.20	2.0	135	0.18	2.0	–	–	–	–	–	55	0.18	1.6	–	–	–	
9	0.4	200	0.20	2.0	105	0.18	2.0	185	0.20	2.0	510	0.24	2.0	45	0.18	1.6	35	0.13	0.3
11	0.4	180	0.20	2.0	95	0.18	2.0	145	0.20	2.0	495	0.24	2.0	35	0.18	1.6	30	0.13	0.3

SM

5

6

SM chip breaker is versatile and the first choice for medium machining of Steels and Super-alloys. It features slightly positive rake angle and stable, moderate T-land. It's also suitable for Stainless steels, Cast irons, and conditionally for Non-ferrous alloys and Hard materials.

10

Pos.	Description
1	Designation of insert
2	Schematic drawing of insert
3	Table with insert sizes (mm)
4	Picture of representative insert
5	Profile of main cutting edge
6	Icons – specific features and cutting edge type

Pos.	Description
7	ISO insert code:Grade
8	Working conditions
9	Insert radii (mm)
10	Geometry description
11	Application area of insert

TURNING HOLDERS – PAGE OVERVIEW

1 DDUN(RL) INT

P M K N S H 2

PRAMET

D 3



Internal Double Clamp Boring Bar with 93° Cutting Angle for DN.. Inserts

Internal Right/Left hand double clamp boring bar, through coolant, 93° cutting angle for DN.. inserts. Suited for wide range of internal turning applications, copy turning up to 27°. Body treated for longer tool life.

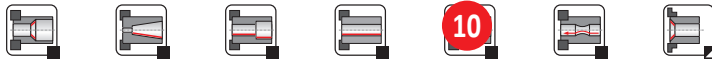
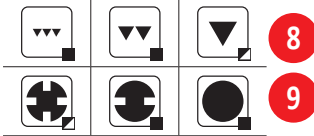
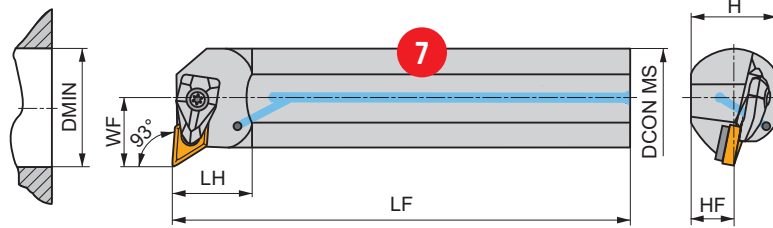
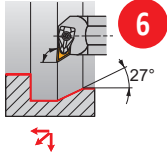

Product	DCON MS	DMIN	WF	H	HF	LF	LH	LAMS	GAMO					
	(mm)	(mm)	(mm)	(mm)	(mm)	(mm)	(mm)	(°)	(°)					
A25T-DDUNR 11	25	32	17	23	11.5	300	28.0	-12	-6	✓	0.96	G1046	DD11	-
A32T-DDUNR 11	32	40	22	30	15	300	30.0	-10	-6	✓	1.68	G1046	DD11	-
A40T-DDUNR 15	40	50	27	37	18.5	300	36.0	-11	-6	✓	2.58	G1044	DD154	AT002
A50U-DDUNR 15	50	63	35	47	23.5	350	39.0	-8	-6	✓	5.25	G1044	DD154	AT002
A25T-DDUNL 11	25	32	17	23	11.5	300	28.0	-12	-6	✓	0.96	G1046	DD11	-
A32T-DDUNL 11	32	40	22	30	15	300	30.0	-10	-6	✓	1.69	G1046	DD11	-
A40T-DDUNL 15	40	50	27	37	18.5	300	36.0	-11	-6	✓	2.59	G1044	DD154	AT002
A50U-DDUNL 15	50	63	35	47	23.5	350	39.0	-8	-6	✓	5.25	G1044	DD154	AT002

A50U-DDUNL 15	50	63	35	47	23.5	350	39.0	-8	-6	✓	5.25	G1044	DD154	AT002
---------------	----	----	----	----	------	-----	------	----	----	---	------	-------	-------	-------

G1044	DN.. 1506..
G1046	DN.. 1104..

DD11	DCS 09	1.7	DDS 266-01	US 2004-T09P	FLAG T09P
DD154	DCS 12	3.9	DDS 266-02	US 2002-T15P	FLAG T15P/3,5

AT002a	DN.. 1504..	DDS 266-01
AT002b	CER DN.N 1506..	DCS 12C4
AT002c	CER DN.A 1506..	DCS 12C2

TURNING HOLDERS – PAGE OVERVIEW

Pos.	Description	Pos.	Description
1	Designation of turning holder	12	ISO code of holder
2	Material group recommendations	13	Dimensions (mm) and angles ²⁾ (°) of holder
3	Clamping system of insert	14	Internal coolant supply
4	Illustrative picture ¹⁾	15	Weight (kg)
5	Tool description	16	Group of compatible inserts ³⁾
6	Workpiece profile	17	Group of spare parts ^{3), 4)}
7	Schematic drawing of tool	18	Group of accessories ^{3), 4)}
8	Achievable quality of surface	19	Compatible inserts
9	Character of cut/working conditions	20	Spare parts
10	Product applications	21	Special accessories
11	Tool design		

¹⁾ Turning holder is primarily displayed in its right design (R)

²⁾ GAMO = orthogonal rake angle (see technical pages)

LAMS = inclination angle of main cutting edge (see technical pages)

³⁾ Code of Group of compatible inserts, spare parts and special accessories is used only for purposes of this catalogue. It cannot be used for orders.

⁴⁾ Spare parts and special accessories icons are designed schematically for ease of understanding. They aren't included in list of icons. Screws are, in some cases, completed with info on torque value in Nm, length of screw and size of thread.

ICONS OVERVIEW

General Icons

	Primary use		Finishing – very good surface quality		Suitable for stable working conditions
	Possible use		Medium machining – good surface quality		Suitable for unstable working conditions
			Roughing – unlimited surface roughness		Suitable for very unstable working conditions

Turning operations

	Longitudinal turning without shoulder – external		Longitudinal turning without shoulder – internal		Deep radial groove
	Longitudinal turning with shoulder – external		Longitudinal turning with shoulder – internal		Parting off
	Cone turning – external		Cone turning – internal		Tube parting off
	Chamfering (beveling)		Chamfering (beveling) in hole		Shallow axial groove
	Face turning without shoulder		Chamfering (beveling) from the back		Shallow and wide axial groove (with following expansion)
	Face turning with shoulder		Machining the rear face (shoulder) from the back		Deep axial groove
	One directional copy turning – external		One directional copy turning – internal		Deep and wide axial groove (with following expansion)
	Multi directional copy turning – external		Multi directional copy turning – internal		Copy turning (multi directional machining)
	Face copy turning		Face copy turning in hole		Face copy turning
	Shallow radial groove		Internal grooving		Thread turning – external
	Shallow groove for o-ring		Internal groove for o-ring		Thread turning – internal
	Wide radial groove (with following expansion)		Internal grooving (with following expansion)		Shaping

ICONS OVERVIEW

General Icons

	Primary use		Finishing – very good surface quality		Suitable for stable working conditions
	Possible use		Medium machining – good surface quality		Suitable for unstable working conditions
			Roughing – unlimited surface roughness		Suitable for very unstable working conditions

Features

	First choice		Large overhang
	Universal wide range option		Heavy working conditions
	For short chipping materials		Insert with Wiper geometry
	For tough materials (long chipping)		High Speed Cutting
	Thin-walled and slim workpieces		High Feed Cutting

Cutting edge condition code (CECC)

	Sharp edge
	Rounded edge
	Edge with facet
	Rounded edge with facet
	Edge with double facet
	Rounded edge with double facet

Technical parts

	Fine finishing		Cutting speed		Clamping torque of screw (Nm)
	Finishing		Feed (mm/rev)		Group of heads for roughing
	Medium machining		Depth of cut (mm)		Internal supply of coolant
	Roughing		Multiplication factor for cutting speed		
	Heavy roughing		Durability (min)		

INSERTS – ISO CODE DESIGNATION

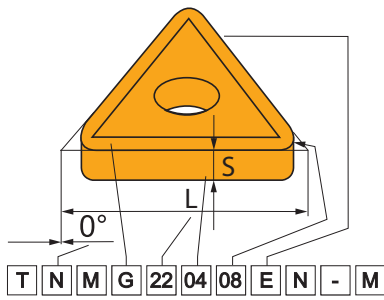

ISO
ANSI

1	2	3	4
T	N	U	N
T	N	M	G
1	2	3	4
T	N	U	
T	N	M	G

1				1			
Insert shape							
H	O	P	R				
S	T	C	D				
E	M	V	W				
L	A	B	K				

2		2	
Insert clearance angle			
A		B	
C		D	
E		F	
G		N	
P		O	Special

4		4	
Insert type			
N			
R			
F			
A			
M			
G			
W			
T			
Q			
U			
B			
H			
C			
J			
X		Special	

3 Tolerances

	(mm)			(")		
	M(±)	S(±)	IC(±)	M(±)	S(±)	IC(±)
A	0.005	0.025	0.025	.0002"	.001"	.0010"
F	0.005	0.025	0.013	.0002"	.001"	.0005"
C	0.013	0.025	0.025	.0005"	.001"	.0010"
H	0.013	0.025	0.013	.0005"	.001"	.0005"
E	0.025	0.025	0.025	.0010"	.001"	.0010"
G	0.025	0.130	0.025	.0010"	.005"	.0010"
J	0.005	0.025	0.05 – 0.13	.0002"	.001"	.002 – 0.005"
K	0.013	0.025	0.05 – 0.13	.0005"	.001"	.002 – 0.005"
L	0.025	0.025	0.05 – 0.13	.0010"	.001"	.002 – 0.005"
M	0.08 – 0.18	0.130	0.05 – 0.13	.003 – 0.007"	.005"	.002 – 0.005"
N	0.08 – 0.18	0.025	0.05 – 0.13	.003 – 0.007"	.001"	.002 – 0.005"
U	0.05 – 0.38	0.130	0.05 – 0.13	.005 – 0.015"	.005"	.003 – 0.010"

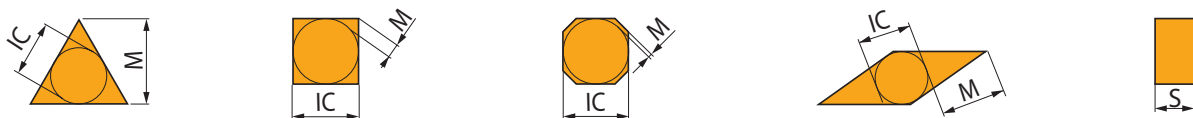

INSERTS – ISO CODE DESIGNATION

5	6	7	8	9	10
22	04	08			
22	04	08	E	N	M
5	6	7	8	9	10
4	3	2			
4	3	2	E	N	M

5													5			6			7		
Insert cutting edge length (insert size)													Insert thickness			Insert nose radius					
d = IC		H	O	P	S	T	C	D	E	M	V	W	R	K	S		RE				
(mm)	(in)														(mm)	(")	(mm)	(")			
3.97					03	06		04			06	02					00	0	0"		
4.76	5/32"				04	08	04	05	04	04	08	L3					02	0.2	1/128"		
5.56	3/16"				05	09	05	06	05	05	09	03					04	0.4	1/64"		
6.35	7/32"	03	02	04	08	11	06	07	08	08	11	04	06				08	0.8	1/32"		
7.94	1/4"	04	03	05	07	13	08	09	06	07	13	05	07				12	1.2	3/64"		
9.525	5/16"	05	04	07	09	16	09	11	09	09	16	06	09	16			16	1.6	1/16"		
12.7	3/8"	07	05	09	12	22	12	15	13	12	22	08	12				24	2.4	3/32"		
15.875	1/2"	09	06	11	15	27	16	19	16	15	27	10	15				32	3.2	1/8"		
19.05	5/8"	11	07	13	19	33	19	23	19	19	33	13	19				Round inserts				
25.40	3/4"	14	10	18	25	44	25	31	26	25	44	17	25				d = I.C.				
31.75	1"	18	13	23	31	54	32	38	32	31	54	21	31				(")	00			
	1 1/4"																(mm)	M0			

ANSI												
5			6			7						
Inscribed circle			Insert thickness			Insert nose radius						
Symbol		d = I.C.	Symbol		S	Symbol		RE				
(mm)	(")	(mm)	(mm)	(")	(mm)	(")	(mm)	(")				
1	3.175	1/8"	1	1.588	1/16"	0	0	0"				
1.2	3.969	5/32"	1.2	1.984	5/64"	0.2	0.099	1/256"				
1.5	4.763	3/16"	1.5	2.381	3/32"	0.5	0.198	1/128"				
1.8	5.556	7/32"	2	3.175	1/8"	1	0.397	1/64"				
2	6.350	1/4"	2.5	3.969	5/32"	2	0.794	1/32"				
2.5	7.938	5/16"	3	4.763	3/16"	3	1.191	3/64"				
3	9.525	3/8"	3.5	5.556	7/32"	4	1.588	1/16"				
4	12.700	1/2"	4	6.350	1/4"	5	1.984	5/64"				
5	15.875	5/8"	5	7.938	5/16"	6	2.381	3/32"				
6	19.050	3/4"	6	9.525	3/8"	7	2.778	7/64"				
7	22.225	7/8"	7	11.113	7/16"	8	3.175	1/8"				
8	25.400	1"	8	12.700	1/2"	10	3.969	5/32"				
10	31.750	5/4"	9	14.288	9/16"	12	4.763	3/16"				
12	38.100	6/4"	10	15.875	5/8"	14	5.556	7/32"				
						16	6.350	1/4"				

8				8			
Insert cutting edge design							
	Sharp edges		Rounded edges				
	Edges with facet		Rounded edges with facet				
	Edges with double facet		Rounded edges with double facet				
9				9			
Feed direction							
R		L		N			
10				10			
Chip breaker designation							

INTERNAL TURNING TOOLS – ISO CODE DESIGNATION

ISO	15	16	17	-	2	3	4	5	6	12	-	14
ANSI	A	25	T	-	D	C	L	N	L	4		

12		12												
		Insert cutting edge length (insert size)												
d = I.C.		H	O	P	S	T	C	D	E	M	V	W	R	K
(mm)	(")													
3.97					03	06		04			06	02		
	5/32"				1.2									
4.76					04	08	04	05	04	04	08	L3		
	3/16"				1.5									
5.56					05	09	05	06	05	05	09	03		
	7/32"				1.8									
6.35		03	02	04	08	11	06	07	08	08	11	04	06	
	1/4"				2									
7.94		04	03	05	07	13	08	09	06	07	13	05	07	
	5/16"				2.5									
9.525		05	04	07	09	16	09	11	09	09	16	06	09	16
	3/8"				3									
12.7		07	05	09	12	22	12	15	13	12	22	08	12	
	1/2"				4									
15.875		09	06	11	15	27	16	19	16	15	27	10	15	
	5/8"				5									
19.05		11	07	13	19	33	19	23	19	19	33	13	19	
	3/4"				6									
25.40		14	10	18	25	44	25	31	26	25	44	17	25	
	1"				8									
31.75		18	13	23	31	54	32	38	32	31	54	21	31	
	1 1/4"				10									

13	
Manufacturer's designation	
M	Clamping system "S" with shim

14	
Manufacturer's designation	
X	Special shank style
•	
•	
93	Z – style tool setting angle
•	
•	

15		15	
Shank			
S	Steel shank		
A	Steel shank with coolant hole		
E	Tungsten carbide shank with coolant hole		

16		16	
Shank Ø (mm)			
		DCON MS (mm)	DCON MS (")
08	8	03	.1875"
10	10	04	.250"
12	12	05	.3125"
16	16	06	.375"
20	20	08	.500"
25	25	10	.625"
32	32	12	.750"
40	40	16	1.000"
50	50	20	1.250"
60	60	24	1.500"
		32	2.000"

17		17	
Holder total Length			
		D	LF (mm)
		E	60
		F	70
		H	80
		J	100
		K	110
		L	125
		M	140
		N	150
		P	160
		Q	170
		R	180
		S	200
		T	250
		U	300
		V	350
		W	400
		X	450
		Y	Spec.
		Z	500

HEADS – ISO CODE DESIGNATION

CARTRIDGE

1	2		3	4	5	6	7
KH	P	-	C	L	N	R	25

HOLDER

8	6	9	10	11
DKH	R	50	60	W

1	2	3	4			
Cartridge	Clamping designation	Insert shape	Holder style – cutting edge angle			
5 Insert clearance angle <table border="1"> <tr> <td>N 0°</td> <td>C 7°</td> <td>P 11°</td> </tr> </table>	N 0°	C 7°	P 11°	C 	S 	A 90°
N 0°	C 7°	P 11°				
	D 	C 80° 	B 75° 			
	P 	T 	C 90° 			
	M 	D 55° 	D 45° 			
	S 	R 	D 93° 			
	X 	K 55° 	E 60° 			
	G 	D 55° 	F 90° 			
		V 35° 	G 90° 			
		X Special 	H 107°30' 			
			J 93° 			
			K 75° 			
			L 95° 			
			M 50° 			
			N 62°30' 			
			P 62°30' 			
			Q 107°30' 			
			R 75° 			
			S 45° 			
			S Special 			
			T 60° 			
			U 93° 			
			V 72°30' 			
			W 60° 			
			X Special 			
			Y 85° 			
			Z K° 			

		7												
		Insert cutting edge length (insert size)												
d=l.c.		H	O	P	S	T	C	D	E	M	V	W	R	K
(mm)	(")													
3.97	5/32"				03	06					06	02		
4.76	3/16"				04	08	04	05	04	04	08	L3		
5.56	7/32"				05	09	05	06	05	05	09	03		
6.35	1/4"	03	02	04	08	11	06	07	08	08	11	04	06	
7.94	5/16"	04	03	05	07	13	08	09	06	07	13	05	07	
9.525	3/8"	05	04	07	09	16	09	11	09	09	16	06	09	16
12.7	1/2"	07	05	09	12	22	12	15	13	12	22	08	12	
15.875	5/8"	09	06	11	15	27	16	19	16	15	27	10	15	
19.05	3/4"	11	07	13	19	33	19	23	19	19	33	13	19	
25.40	1"	14	10	18	25	44	25	31	26	25	44	17	25	
31.75	1 1/4"	18	13	23	31	54	32	38	32	31	54	21	31	

8
Cartridge holder

9
Shank height (mm)

08 10 12 16 20 25
32 40 50 60 70 80

10
Shank width (mm)

08 10 12 16 20 25
32 40 50 60 70 80

11
Holder total length

	LF (mm)
H	100
J	110
K	125
L	140
M	150
N	160
P	170
Q	180
R	200
S	250
T	300
U	350
V	400
W	450
X	Spec.
Y	500

PARTING-OFF & GROOVING INSERTS – GL – CODE DESIGNATION

1	2	3	4	5	6	7	8
GL	3	-	D	300	G	02	L06 - PM



1	2	3	4
Tool group	Pocket size	Number of edges	Cutting width – CW

1, 2, 3, 4, 5, 6

GL

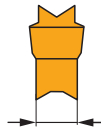

S	One edge
D	Two edges

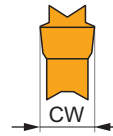

	CW
150	1.50
200	2.00
250	2.50
300	3.00
400	4.00
500	5.00
600	6.00
800	8.00

5	6	7	8
Edge design	Nose radius	Primary cutting edge angle	Chipbreaker designation

G	Ground
M	Direct pressed

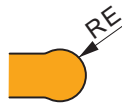
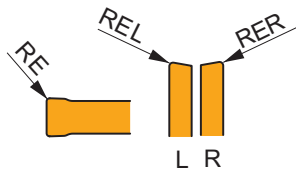

	RE, RER, REL (mm)
015	0.15
02	0.2
03	0.3
04	0.4
08	0.8

ROUND GEOMETRY	
	RE (mm)
MO	RE = CW/2

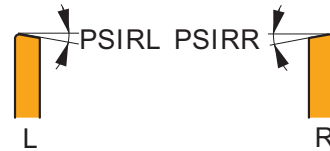

	(°)
06	6
12	12

PM
PR
GM
MM

PARTING – OFF & GROOVING HOLDERS (EXTERNAL TURNING) – GL – CODE DESIGNATION

1	2	3	4	5	6	7	8	9	10	11			
GL	3	-	S	2525	M	F	R	-	20	-	R	120	090

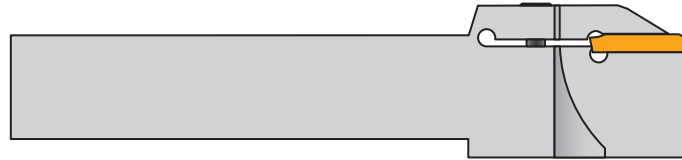

1	2	3	4
Tool group	Pocket size	Shank type	Shank dimensions

1, 2, 3, 4, 5, 6

GL

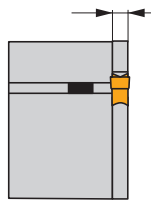

A	steel shank with internal coolant
S	steel shank without internal coolant

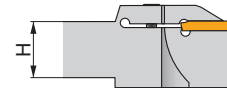

	H × B (mm)
1212	12 × 12
1616	16 × 16
2020	20 × 20
2525	25 × 25
3232	32 × 32

5	6	7	8
Holder total length – LF	Tool style – cutting edge angle	Version (right/left)	Cutting depth maximum – CDX

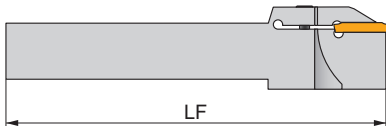

	LF (mm)
H	100
K	125
M	150
P	170

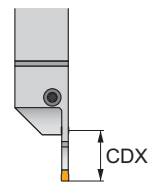
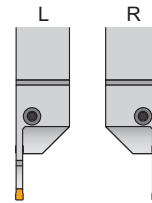
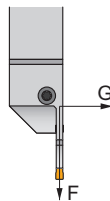

9	10	11
Blade curvature direction	Maximum diameter	Minimum diameter

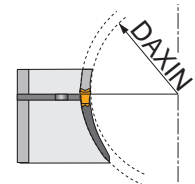
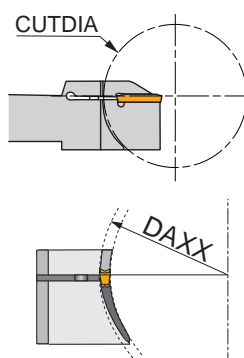
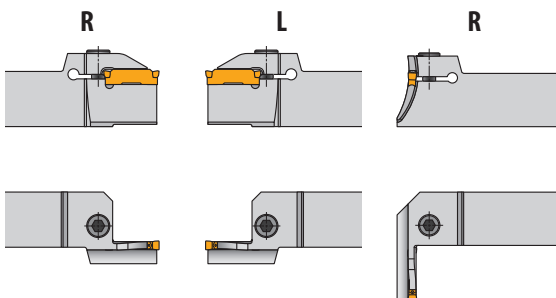

Additional information for axial turning.

PARTING – OFF & GROOVING TOOLS – EXTERNAL TURNING – ISO CODE DESIGNATION

	1	2	3	4	5	6	7	8	9	10	11
ISO	G	F	I	L	25	25	M	0316	R	030	017
ANSI	1	2	3	4	5 & 6	7	8	9	10	11	
	G	F	I	L	16	D	0316	R	1.18	.670	



1	1	2	2	3	3	4	4
Clamping designation		Holder style – cutting edge angle		Cutting depth maximum – CDX		Version (right/left) R/L	

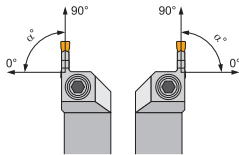
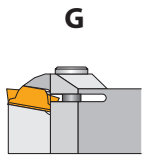

α°	
G = 0°	K = 75°
R = 15°	F = 90°
T = 30°	B = 105°
S = 45°	E = 120°
W = 60°	D = 135°



G = 2.0 × CW	N = 5.5 × CW
H = 2.5 × CW	O = 6.0 × CW
I = 3.0 × CW	P = 6.5 × CW
J = 3.5 × CW	Q = 7.0 × CW
K = 4.0 × CW	R = 7.5 × CW
L = 4.5 × CW	S = 8.0 × CW
M = 5.0 × CW	T = 8.5 × CW

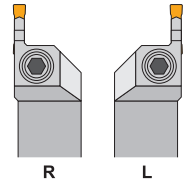

5	5	6	6	7	7	8	8
Shank height (mm)		Shank width (mm)		Holder total length		Insert width	

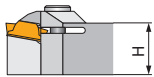

12 = 12 mm
16 = 16 mm
20 = 20 mm
etc.

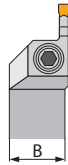

12 = 12 mm
16 = 16 mm
20 = 20 mm
etc.

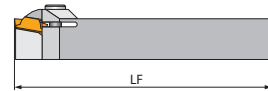

	LF (mm)		LF (")
H	100	A	4.000"
J	110	B	4.500"
K	125	C	5.000"
L	140	D	6.000"
M	150	E	7.000"
N	160	F	8.000"
P	170		
Q	180		
R	200		

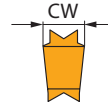

	CW (mm)	CW (")
02	2.0	.079"
03, 0313, 0316	3.0	.118"
04, 0413, 0416	4.0	.157"
05, 0516	5.0	.197"
06, 0616	6.0	.236"
08, 0830	8.0	.315"

5 & 6		
	B (")	H (")
05	5/16"	5/16"
06	3/8"	3/8"
08	1/2"	1/2"
10	5/8"	5/8"
12	3/4"	3/4"
16	1"	1"
85	1"	1 1/4"
86	1"	1 1/2"
20	1 1/4"	1 1/4"
24	1 1/2"	1 1/2"
32	2"	2"

For square shanks, the number is the width or height in terms of 16ths. For rectangular shanks the first digit is the width in terms of 8ths and the second digit is the height in terms of 4ths.

10	10
Maximum diameter – face grooving	
Additional information for axial turning	

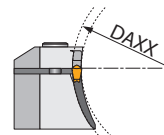

9	9
Blade curvature direction	
Additional information for axial turning	

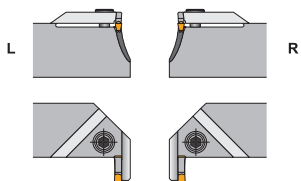

11	11
Minimum diameter – face grooving	
Additional information for axial turning	

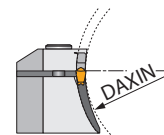

PARTING – OFF & GROOVING BLADES (EXTERNAL TURNING) – GL – CODE DESIGNATION

1	2	3	4	5	6	7	8
GL	1	– S	26	K	B	R	– 16



1	2	3
Tool group	Pocket size	Shank type

1, 2, 3, 4, 5, 6

GL

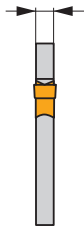

A	Steel shank with internal coolant
S	Steel shank without internal coolant

4	5	6
Shank dimensions	Blade total length – LF	Tool style



	H (mm)
26	26
29	29
32	32

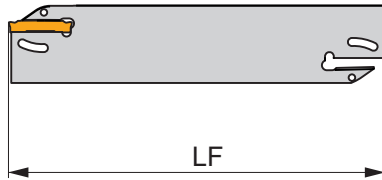

	LF (mm)
C	50
K	125
M	150

B – blade
BS – modular blade

7	8
Version (right/left)	Cutting depth maximum – CDX

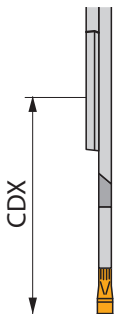
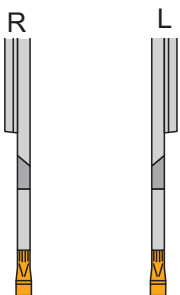

PARTING – OFF & GROOVING HOLDERS (INTERNAL TURNING) – GL – CODE DESIGNATION

1	2	3	4	5	6	7	8	9
GL	3	-	A	32	S	G	R	-
							12	-
								45

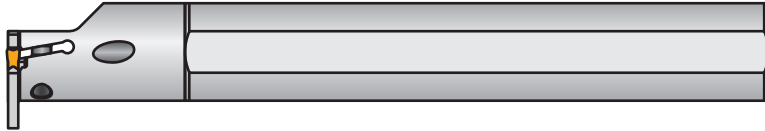

1	2	3	4
Tool group	Pocket size	Shank type	Shank dimensions

2, 3, 4

GL

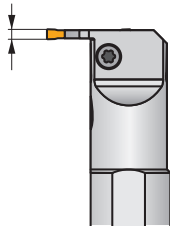

A	Steel shank with internal coolant
S	Steel shank without internal coolant

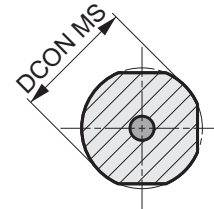

	DCON MS (mm)
25	25
32	32
40	40

5	6	7	8
Holder total length – LF	Tool style – cutting edge angle	Version (right/left)	Cutting depth maximum – CDX

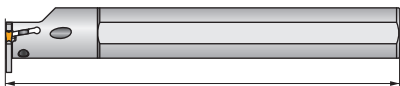

	LF (mm)
Q	180
S	250
T	300

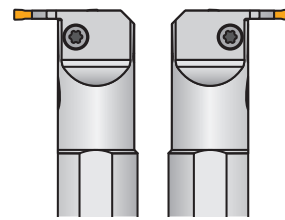
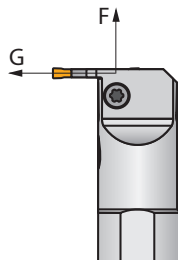

R L

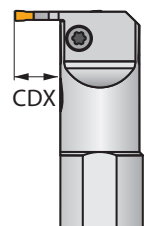

9
Minimum diameter

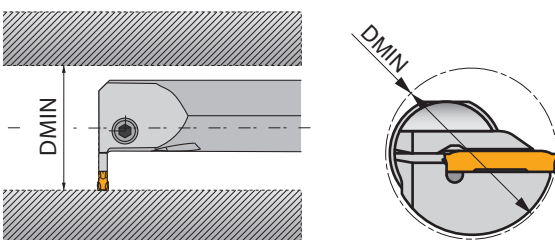

PARTING – OFF & GROOVING TOOLS – INTERNAL TURNING – ISO CODE DESIGNATION

ISO	1 A	2 25	3 S	-	4 G	5 G	6 H	7 L	8 0313
ANSI	1 A	2 16	3 S	-	4 G	5 G	6 H	7 L	8 0313





1		2		2		3	
Shank		Diameter of shank		Diameter of shank		Holder total length	
S	Steel shank						
		DCON MS (mm)		DCON MS (")			
A	Steel shank with coolant hole	12	12	08	.500"		
		16	16	10	.625"		
		20	20	12	.750"		
		25	25	16	1.000"		
		32	32	20	1.250"		
		40	40	24	1.500"		

4		5		6																							
Clamping designation		Tool style – cutting edge angle		Cutting depth maximum – CDX																							
G																											
		<table border="1"> <thead> <tr> <th colspan="2">α°</th> </tr> </thead> <tbody> <tr> <td>G = 0°</td> <td>K = 75°</td> </tr> <tr> <td>R = 15°</td> <td>F = 90°</td> </tr> <tr> <td>T = 30°</td> <td>B = 105°</td> </tr> <tr> <td>S = 45°</td> <td>E = 120°</td> </tr> <tr> <td>W = 60°</td> <td>D = 135°</td> </tr> </tbody> </table>		α°		G = 0°	K = 75°	R = 15°	F = 90°	T = 30°	B = 105°	S = 45°	E = 120°	W = 60°	D = 135°	<table border="1"> <tbody> <tr> <td>E = 1.0 × CW</td> <td>J = 3.5 × CW</td> </tr> <tr> <td>F = 1.5 × CW</td> <td>K = 4.0 × CW</td> </tr> <tr> <td>G = 2.0 × CW</td> <td>L = 4.5 × CW</td> </tr> <tr> <td>H = 2.5 × CW</td> <td>M = 5.0 × CW</td> </tr> <tr> <td>I = 3.0 × CW</td> <td>N = 5.5 × CW</td> </tr> <tr> <td colspan="2" style="text-align: center;">X = Special</td> </tr> </tbody> </table>		E = 1.0 × CW	J = 3.5 × CW	F = 1.5 × CW	K = 4.0 × CW	G = 2.0 × CW	L = 4.5 × CW	H = 2.5 × CW	M = 5.0 × CW	I = 3.0 × CW	N = 5.5 × CW
α°																											
G = 0°	K = 75°																										
R = 15°	F = 90°																										
T = 30°	B = 105°																										
S = 45°	E = 120°																										
W = 60°	D = 135°																										
E = 1.0 × CW	J = 3.5 × CW																										
F = 1.5 × CW	K = 4.0 × CW																										
G = 2.0 × CW	L = 4.5 × CW																										
H = 2.5 × CW	M = 5.0 × CW																										
I = 3.0 × CW	N = 5.5 × CW																										
X = Special																											

7		8							
Version (right/left) R/L		Insert width							
R	L								
		<table border="1"> <thead> <tr> <th></th> <th>CW (mm)</th> </tr> </thead> <tbody> <tr> <td>0313</td> <td>3.0</td> </tr> <tr> <td>0413</td> <td>4.0</td> </tr> </tbody> </table>			CW (mm)	0313	3.0	0413	4.0
	CW (mm)								
0313	3.0								
0413	4.0								

INDEXABLE CUTTING INSERTS FOR THREADING ISO – CODE DESIGNATION

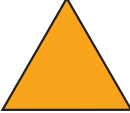
ISO	1	2	3	4	5	6	7	–	8
	T	N	16	E	R	175	M		P1
ANSI	1	2	3	4	5	6	7		8
	T	N	16	E	R	120	W		P1

	1	1	2	2	3	3	4	4																				
	Insert shape		Insert clearance angle		Insert cutting edge length (insert size)																							
T					 <div style="display: flex; justify-content: space-around; font-size: small;"> <div style="text-align: center;">L</div> <div style="text-align: center;">d = IC</div> </div> <table border="1" style="margin: 5px auto; font-size: x-small; border-collapse: collapse;"> <thead> <tr> <th></th> <th>(mm)</th> <th>(")</th> <th>(mm)</th> <th>(")</th> </tr> </thead> <tbody> <tr> <td>11</td> <td></td> <td>.433"</td> <td>6,350</td> <td>1/4"</td> </tr> <tr> <td>16</td> <td></td> <td>.650"</td> <td>9,525</td> <td>3/8"</td> </tr> <tr> <td>22</td> <td></td> <td>.866"</td> <td>12,7</td> <td>1/2"</td> </tr> </tbody> </table>			(mm)	(")	(mm)	(")	11		.433"	6,350	1/4"	16		.650"	9,525	3/8"	22		.866"	12,7	1/2"	E	External
	(mm)	(")	(mm)	(")																								
11		.433"	6,350	1/4"																								
16		.650"	9,525	3/8"																								
22		.866"	12,7	1/2"																								
							N	Internal																				

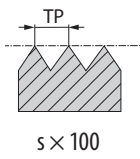
	5	5	6	6	7	7		
	Direction of cut		Thread pitch		Thread profile			
R	Right		 Thread Pitch mm × 100		M	Metric 60°	TR	TR 30° ISO 2901/3–1977
L	Left		<div style="border: 1px solid black; padding: 2px; width: fit-content; margin: 0 auto;">6</div> No. of threads		MJ	SEA MA1370	UN	American UN 60° ISO 5864–1978
N	Neutral		No. of threads per inch × 10		W	Whitworth 55° ISO 228–1982	UNJ	SEA AS8879
					RD	Round 30°	ACME	ACME 29° ANSI B1.5–1988
					BSPT	ISO 228/1 35 21 1959 ISO 7/1	STACME	ASME/ANSI B1.8-1988
					NPT	ANSI B1.1–1983	API RD	API

	8	8
	Chip breaker designation	
P1	Pressed	
AL	For nonferrous	

ISO CODE DESIGNATION – HOLDERS THREADING

ISO	1	2	3	–	4	5	6	7	–	8
	S	E	R	–	S	2525	M	16	–	
ANSI	1	2	3	–	4	5	6	7	–	8
	S	E	R	–	S	16	D	16	–	

1		2		3		4			
Clamping designation		Machining orientation		Direction of cut		Type of construction			
C		E	External	R	Right	External		–	Normal
	P						Internal		
M			I	Internal	L	Left	External		S
	S						Internal		

5		6		7		
Holder dimensions (mm)		Holder total length (mm)		Insert cutting edge length (insert size)		
External turning	2525	25 × 25 mm			d = IC	T
Internal turning	1416	Shank – 14 mm Shank height Ø – 16 mm			(mm)	(")

5		6		8			
Tool dimensions (")		Holder total length (")		Helix angle λ			
	B (")	H (")		LF (")	0 Helix angle λ = 0°		
	10	5/8"		5/8"		C	5.000"
	12	3/4"		3/4"		D	6.000"
	16	1"		1"		E	7.000"
	85	1"		1 1/4"		F	8.000"
	86	1"		1 1/2"		K	5.000"
20	1 1/4"	1 1/4"	M	6.000"	1 Helix angle λ = 1°		
		DCON (")	P	6.250"			
		08	.500"	Q		7.250"	
		10	.625"	R		8.000"	
		12	.750"	S		10.000"	
		16	1.000"	T		12.000"	
		20	1.250"	U	14.000"		
24	1.500"			2 Helix angle λ = 2°			

CUTTING TOOL PARAMETERS ACCORDING TO ISO 13399

All cutting tools are defined by a number of parameters according to the standard ISO 13399. This list contains all the parameters used in this catalogue and their definitions.

ISO 13399 is an international cutting tool information standard. It provides dimensions and parameters in a neutral format that is independent of any particular system or company nomenclature. When cutting tools are clearly defined according to a global standard, all types of software can process the electronic data more quickly, improving the quality of communication and helping to make the exchange of information run smoothly. Supporting a common language in our cutting tool descriptions this will assist system to system communication. It will save you a significant amount of time, providing an easier gathering of high-quality data across our 40,000 solid and indexable tools. By using an ISO 13399 compliant system, there will be no need to manually interpret data and key-enter it into your system.

EXAMPLES ONLY!

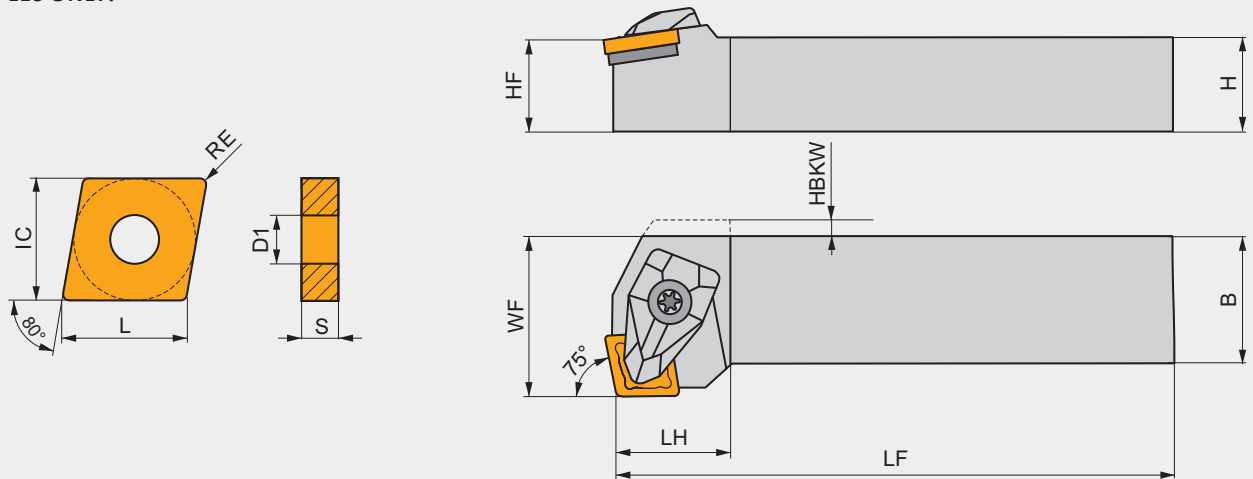

ISO 13399	Description
APMX	Depth of cut maximum
B	Shank width
BD	Body diameter
BLRAD	Blade reinforcement radius
BW	Insert body width
CDX	Cutting depth maximum
CND	Coolant entry diameter
CUTDIA	Work piece parting diameter maximum
CW	Cutting width
CWTOLL	Cutting width lower tolerance
CWTOLU	Cutting width upper tolerance
D1	Fixing hole diameter
DAXIN	Minimum axial groove inside diameter
DAXN	Minimum axial groove outside diameter
DAXX	Maximum axial groove outside diameter
DCON MS	Connection diameter
DMIN	Minimum bore diameter
DMINP	Minimum bore diameter perpendicular
GAMO	Orthogonal rake angle
GAMP	Axial rake angle
H	Shank height
HBH	Head bottom offset height
HBKW	Head bottom offset width
HF	Functional height
IC	Inscribed circle diameter
INSD	Insert diameter
INSL	Insert length

ISO 13399	Description
KAPR	Tool cutting edge angle
L	Cutting edge length
LAMS	Inclination angle
LB	Body length
LF	Functional length
LFA	A dimension on LF
LFS	Functional length secondary
LH	Head length
LU	Usable length
M	M-dimension
OAL	Overall length
PDX	Profile distance X
PDY	Profile distance Y
PSIRL	Tool lead angle left
PSIRR	Tool lead angle right
RE	Corner radius
S	Insert thickness
S1	Insert thickness total
TP	Thread pitch
TPI	Threads per inch
TPIN	Threads per inch
TPIX	Threads per inch
TPN	Thread pitch minimum
TPX	Thread pitch maximum
W1	Insert width
WF	Functional width
WFS	Functional width secondary

TURNING GRADES

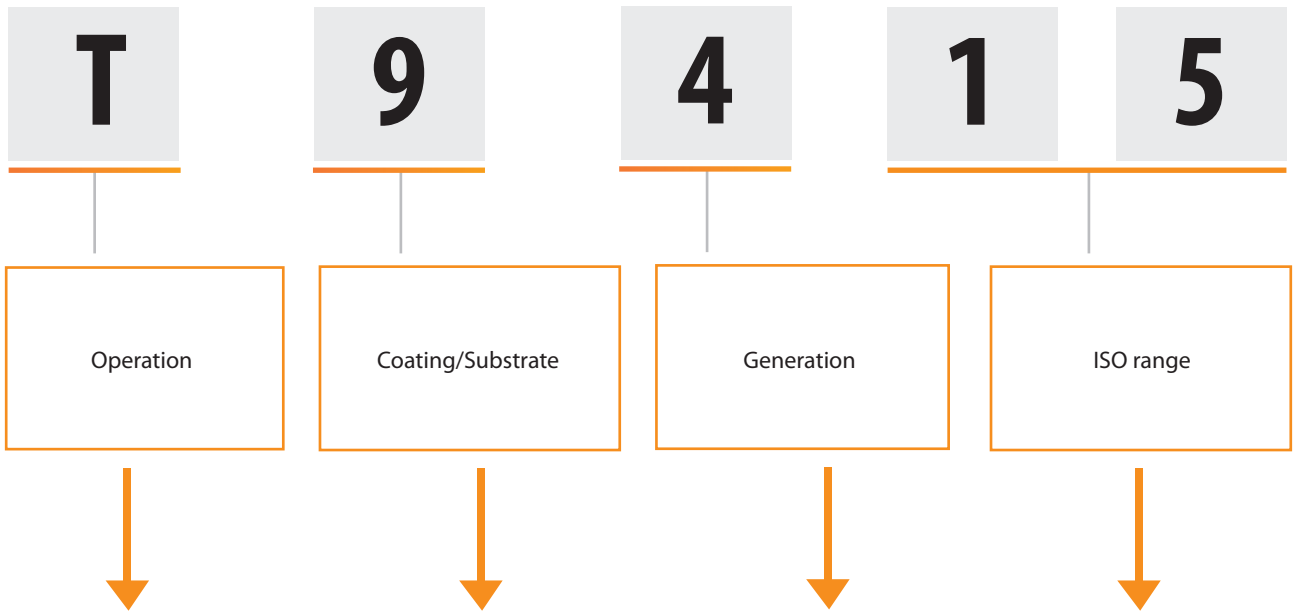

D	Drilling	0 PVD 1 CVD	Special application	1 – 9	01 – 50
M	Milling	2 PVD 3 CVD	Free		
T	Turning	4 PVD 5 CVD	Group K, H		05 – 10
G	Grooving and Parting off	6 PVD 7 CVD	Group M, S		10 – 20
		8 PVD 9 CVD	Universal		20 – 30
		B	CBN		30 – 40
		C	Ceramic		40 – 50
		D	PCD		
		T	Cermet		

ISO TURNING GRADES – NAVIGATOR

ISO	MTCVD coated carbide	PVD coated carbide	Uncoated carbide	CERMET
P01				
P05				TT010
P10		T8415		
P15	T9415			
P20				TT310
P25	T9325			
P30		T8430		
P35				
P40	T9335			
P45				
P50				

ISO	MTCVD coated carbide	PVD coated carbide	Uncoated carbide	CERMET
M01				
M05				
M10		T8415		
M15	T7325			
M20				
M25		T8430		
M30	T7335			
M35				
M40				

ISO	MTCVD coated carbide	PVD coated carbide	Uncoated carbide	CER
K01				TC100
K05	T5305			
K10				
K15	T5315	T8415	HF7	
K20				
K25				
K30		T8430		
K35				
K40				

ISO	MTCVD coated carbide	PVD coated carbide	Uncoated carbide	PCD
N01				
N05				
N10		T0315		
N15				
N20			HF7	PD1
N25				
N30				



































ISO	MTCVD coated carbide	PVD coated carbide	Uncoated carbide	CER
S01				
S05				
S10		T6310		
S15		T8415	H07	
S20	T7325			
S25	T7335			
S30				

ISO	MTCVD coated carbide	PVD coated carbide	Uncoated carbide	CBN
H01				
H05				TB310
H10	T5305	T6310		
H15		T8415		
H20	T9415			
H25				
H30				

CVD TURNING GRADES

Grade Identification	Area of Application	Application	Feed	Cutting speed	Resistance to adverse Working Conditions	Coating	Colour	Substrate	Coolant benefit	Grade description
T9415 NEW	P05 - P30	■				MT-CVD	FGM	FGM	++	Highly wear-resistant material designed primarily for finish turning of common carbon and alloy steels. Despite its high abrasion resistance, it is also suitable for interrupted cutting operations. We recommend this material as the first choice for most turning operations, especially in high production applications.
	K05 - K25	▣	▴	▴	▴					
	H10 - H20	▣								
T9310	P01 - P15	■				MT-CVD	FGM	FGM	++	Grade with high abrasion resistance which can be used for slightly interrupted cutting. It will be used for finishing or semi-roughing operations. This material can also be used for roughing operations provided the machine-tool-workpiece configuration is sufficiently rigid.
	K05 - K20	▣	▴	▴	▴					
	H10 - H20	▣								
T9315	P05 - P25	■				MT-CVD	FGM	FGM	++	A versatile grade with excellent wear resistance properties even under intense cutting conditions. It can also be used for operations with interrupted cuts.
	K05 - K25	▣	▴	▴	▴					
	H10 - H20	▣								
T9325	P15 - P35	■				MT-CVD	FGM	FGM	++	From a technological perspective this is an extremely versatile grade with high resistance to mechanical damage in adverse cutting conditions and retains excellent wear resistance. The correct application of this material requires high cutting speeds.
	M10 - M30	▣	▴	▴	▴					
	K15 - K35	▣	▴	▴	▴					
	S10 - S20	▣								
T9335	P20 - P45	■				MT-CVD	FGM	FGM	+++	One of the toughest grades which is especially suitable for adverse cutting conditions at medium to high feed rates and medium cutting speeds. Compared to its predecessors, M15 – M40 it is not only tougher, but also more abrasion resistant which will be useful when using intensive cutting conditions.
	M15 - M40	▣	▴	▴	▴					
	S15 - S25	▣								
T9226	P15 - P35	■				MT-CVD	FGM	FGM	+++	Grade designed for heavy roughing applications. A versatile grade with high resistance to mechanical damage and retains very good wear resistance. Usable at lower cutting speeds.
	M10 - M30	▣	▴	▴	▴					
	K15 - K35	▣	▴	▴	▴					
	S15 - S25	□								
T7325	P15 - P35	▣				MT-CVD	FGM	FGM	+++	One of the most universal turning grades. Especially designed for stainless steel machining. Optimal balance between wear resistance and performance reliability. Suitable for broad variety of application in turning operations.
	M10 - M25	▣	▴	▴	▴					
	S10 - S25	■								
T7335	P20 - P40	▣				MT-CVD	FGM	FGM	+++	Grade with functionally graded substrate, featuring very high operational reliability and very good wear-resistance. It is best suited to use in the machining of very tough M20 – M40 materials.
	M20 - M40	▣	▴	▴	▴					
	S15 - S25	■								
T5305	P05 - P15	▣				MT-CVD	H	H	+	Grade with very high resistance to chemical wear; suitable for finishing operations using high cutting speeds. With its high abrasion resistance, it is also suitable for productive K01 – K15, machining of hardened and treated materials.
	K01 - K15	▣	▴	▴	▴					
	H05 - H15	▣								
T5315	P10 - P25	▣				MT-CVD	H	H	+	Grade intended primarily for productive machining which has high abrasion resistance and good operational reliability. Due to its properties, this material is particularly suitable for roughing and finishing operations for good or slightly adverse cutting conditions.
	K10 - K25	▣	▴	▴	▴					
	H15 - H25	▣								
6640	P20 - P40	■				MT-CVD	H	H	+++	One of the toughest turning materials which can be used especially in roughing operations, or where operational reliability under adverse cutting conditions is a priority. Another ideal choice for machines working with low to medium cutting speeds and medium to high feed rates.
	M20 - M35	▣	▴	▴	▴					
	K25 - K40	▣	▴	▴	▴					

PVD TURNING GRADES

Grade Identification	Area of Application	Application	Feed	Cutting speed	Resistance to adverse Working Conditions	Coating	Colour	Substrate	Coolant benefit	Grade description
T8415 NEW	P05 - P20	<input type="checkbox"/>				PVD	Yellow	Submicron H	++	A versatile, high performance turning grade primarily intended for steel machining, but well suitable for stainless steels and heat resistant super alloys (HRSA) too, possibly applicable for hardened steels. It is suitable for machining at wide range of cutting speeds, light to medium feeds and under good cutting conditions, preferably with coolant.
	M05 - M20	<input type="checkbox"/>								
	K05 - K25	<input type="checkbox"/>								
	N05 - N25	<input checked="" type="checkbox"/>								
	S05 - S15	<input type="checkbox"/>								
T8315	P05 - P20	<input checked="" type="checkbox"/>				PVD	Yellow	Submicron H	++	Grade featuring excellent abrasion resistance while maintaining above average operational reliability, it is suitable for machining at medium to high cutting speeds in short chipping harder materials.
	M05 - M20	<input type="checkbox"/>								
	K05 - K25	<input type="checkbox"/>								
	N05 - N25	<input type="checkbox"/>								
	S05 - S15	<input checked="" type="checkbox"/>								
T8430	P20 - P40	<input type="checkbox"/>				PVD	Yellow	Submicron H	+++	Undoubtedly the most versatile cutting material, this is useful for machining of all types of machined materials and is practically applicable in almost all types of turning operations. Its main benefits are its high operational reliability and very good frictional properties; it is therefore suitable for applications at medium and lower cutting speeds.
	M20 - M35	<input type="checkbox"/>								
	K25 - K40	<input checked="" type="checkbox"/>								
	N15 - N30	<input checked="" type="checkbox"/>								
	S15 - S25	<input checked="" type="checkbox"/>								
T8345	P30 - P50	<input type="checkbox"/>				PVD	Yellow	Submicron H	+++	This is the toughest turning grade, which is intended mainly for machining under the worst cutting conditions and in applications with the highest requirements for operating reliability. Because of these properties, this material is recommended for lower cutting speeds.
	M20 - M40	<input checked="" type="checkbox"/>								
	K30 - K40	<input checked="" type="checkbox"/>								
	S20 - S30	<input checked="" type="checkbox"/>								
T6310	P01 - P15	<input type="checkbox"/>				PVD	Grey	Ultra submicron H	+++	High wear resistant turning grade with top PVD coating. Suitable for finishing operation and applications, where sharp cutting edge together with high flank wear resistance is of high importance
	M01 - M15	<input type="checkbox"/>								
	K05 - K20	<input type="checkbox"/>								
	N05 - N20	<input type="checkbox"/>								
	S01 - S15	<input type="checkbox"/>								
T0315	N05 - N20	<input type="checkbox"/>				PVD	Yellow	Submicron H	++	Submicron grade for turning non-ferrous metals and their alloys with a balance of wear resistance and toughness. It is provided with a unique coating with excellent friction properties.
G8330 	P25 - P40	<input type="checkbox"/>				PVD	Yellow	Submicron H	+++	Universal cutting grade for grooving and parting-off applications. This grade is characterized by its exceptional reliability and versatility. Developed to fit machining conditions for most workpiece materials.
	M20 - M35	<input type="checkbox"/>								
	K20 - K40	<input type="checkbox"/>								
	N15 - N30	<input checked="" type="checkbox"/>								
T8330 	P25 - P40	<input type="checkbox"/>				PVD	Yellow	Submicron H	+++	Undoubtedly the most versatile cutting material, this is useful for machining of all types of machined materials and is practically applicable in almost all types of turning operations. Its main benefits are its high operational reliability and very good frictional properties; it is therefore suitable for applications at medium and lower cutting speeds.
	M20 - M35	<input type="checkbox"/>								
	K20 - K40	<input type="checkbox"/>								
	N15 - N30	<input checked="" type="checkbox"/>								
	S15 - S25	<input checked="" type="checkbox"/>								
T8010 	P05 - P15	<input type="checkbox"/>				PVD	Yellow	Submicron H	+++	This grade is suitable for continuous high precision thread turning of steels, stainless steel, cast iron and super alloys. Offering excellent wear resistance while ensuring operational reliability
	M05 - M15	<input type="checkbox"/>								
	K10 - K20	<input type="checkbox"/>								
	S10 - S15	<input checked="" type="checkbox"/>								
T8030 	P25 - P40	<input type="checkbox"/>				PVD	Yellow	Submicron H	+++	Undoubtedly the most versatile grade it is suitable for machining all types of materials and can be applied in almost all turning operations. It's main benefits are high operational reliability and excellent frictional properties; it is therefore suited to applications at medium to low cutting speeds.
	M20 - M35	<input type="checkbox"/>								
	K20 - K40	<input type="checkbox"/>								
	N15 - N30	<input checked="" type="checkbox"/>								
	S15 - S25	<input checked="" type="checkbox"/>								

OTHER TURNING GRADES

Grade Identification	Area of Application	Application	Feed	Cutting speed	Resistance to adverse Working Conditions	Coating	Colour	Substrate	Coolant benefit	Grade description
HF7	M10 - M20	■				×		submicron H	++	Uncoated grade which is primarily designed for machining non-ferrous metals; but can also be used for other machined materials (except steel). This material can be used in turning, milling, and even boring.
	K10 - K25	■								
	N10 - N25	■								
H07	M05 - M15	■				×		submicron H	++	Uncoated turning grade suitable for machining applications where oxidation resistance is not dominating criterion of tool life. Designed for machining of Ti-based alloys. Grade exhibits high strength of cutting edge together with good wear resistance.
	K10 - K25	■								
	N10 - N30	■								
TT310	P10 - P25	■				PVD		cermet	+ / -	Coated cermet used for fine and finish turning of carbon and alloy steels (including stainless). Its excellent friction properties are further improved by the coating applied using the PVD technique.
	M15 - M25	■								
TT010	P01 - P10	■				×		cermet	+ / -	Uncoated cermet, which is suitable for fine machining of all types of steel (including stainless) at very low feed rates. Its main advantage is the minimal radius of the cutting edge and its high resistance to physical and chemical wear mechanisms.
	M01 - M10	■								
TC100	K01 - K15	■				×		ceramics	--	Ceramic grade for cast iron machining. Suitable for machining with high cutting speed at stable conditions.
TB310	K01 - K10	■				×		CBN	--	CBN grade for machining of hardened materials. Suitable for machining with high cutting speed and small feeds at stable conditions.
	S05 - S10	■								
	H01 - H10	■								
PD1	N05 - N25	■				×		PCD	-	PKD grade for turning non-ferrous materials. Ideal choice for working with high cutting speed and small feeds at stable conditions.
333TN	P45 - P50	■				PVD		HSS	+++	Special grade composed of HSS substrate and thin hard PVD coating. The most tough cutting grade in the portfolio. Inserts with this grade are one and only used for slotting of key groove.
	M35 - M40	■								
	K35 - K40	■								

Substrat	
H	WC-Co based substrate
submicron H	WC-Co based substrate fine grained (< 1 μm)
ultra submicron H	WC-Co based substrate very fine grained (< 0,5 μm)
FGM	Functionally graded substrate
Cermet	Cemented carbide without WC
ceramics	Cutting ceramics
PCD	Polycrystalline Diamond
CBN	Cubic Boron Nitride
HSS	High speed steel

Coating	
MT-CVD	Medium-temperature chemical method of coating
PVD	Low-temperature physical method of coating
×	Uncoated grade

Benefits of cutting fluid	
+++	Use of coolant is essential
++	Highly recommended
+	Recommended
+ / -	Optional
--	Do not use coolant
-	Coolant not recommended

DEFINITION OF BASIC TERMS

Insert parts

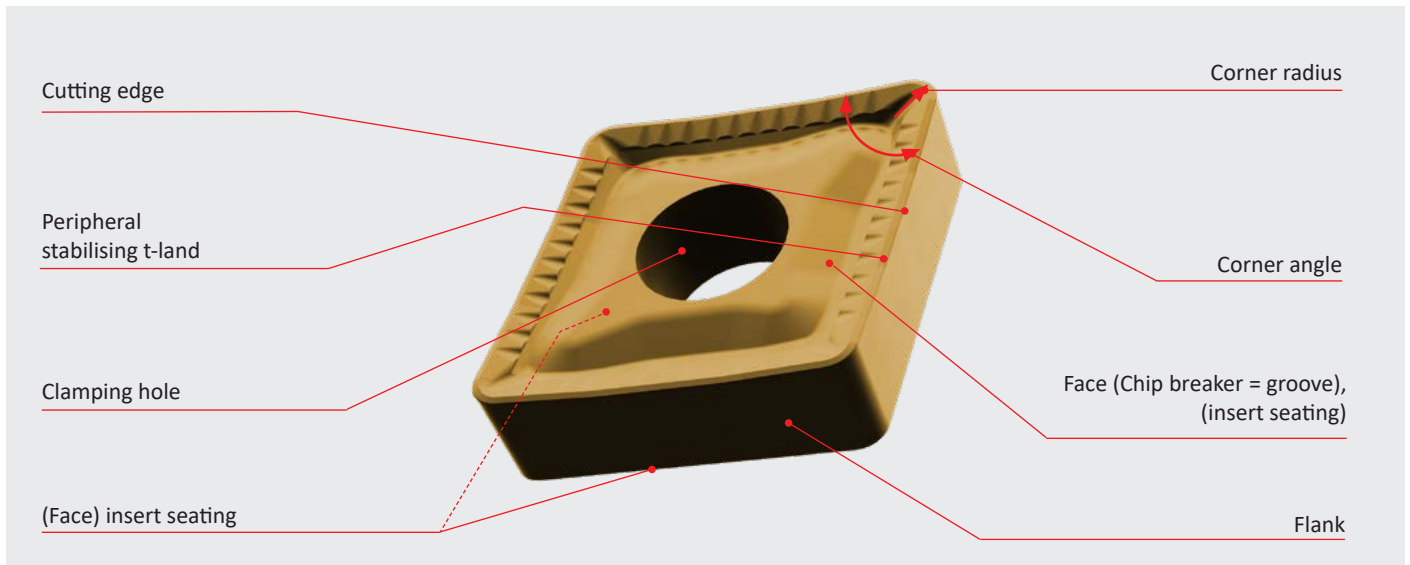

The **corner radius** – determines in most cases the recommended minimum depth of cut and, together with the feed, also determines the achieved roughness.

The **Cutting edge** is the intersection of face and flank surfaces. Its longitudinal roughness is one of the first evaluation criteria when assessing an insert.

The **insert corner angle** is very important with regard to the usable cutting edge length, resistance in the interrupted cut, heat dissipation from the cutting point, etc.

The **peripheral stabilising t-land** is an area located after the cutting edge. Its width is very often variable and its angle also changes regularly. In most cases, the width of the t-land, together with the adjustment angle at which the insert works, is a limiting factor for specifying the minimum feed.

The **chip breaker** – together with the t-land determines the application area (narrow grooves – finishing and materials with short chip, wide grooves – mostly roughing operations and tough materials).

The **clamping hole** – if there is no hole, the insert will definitely be designed for the ISO C clamping system. If the hole is cylindrical, the insert is designed for the ISO P, M, D + clamping systems (in nearly all cases the flank angle is 0°. If the hole is trumpet-shaped and the flank angle is positive, the insert is single-sided and is designed for the ISO S clamping system. If the hole is conical and is the same on both sides of the insert, then it is most likely a tangential insert (double-sided).

The **insert seating** – if it is formed by the same relief as the face surface, the insert is double-sided, if it is different, the insert is single-sided. It must be assessed with regard to the planned load or the type of cut. (the size and distance of the radius and the cutting edges).

Tool holder parts

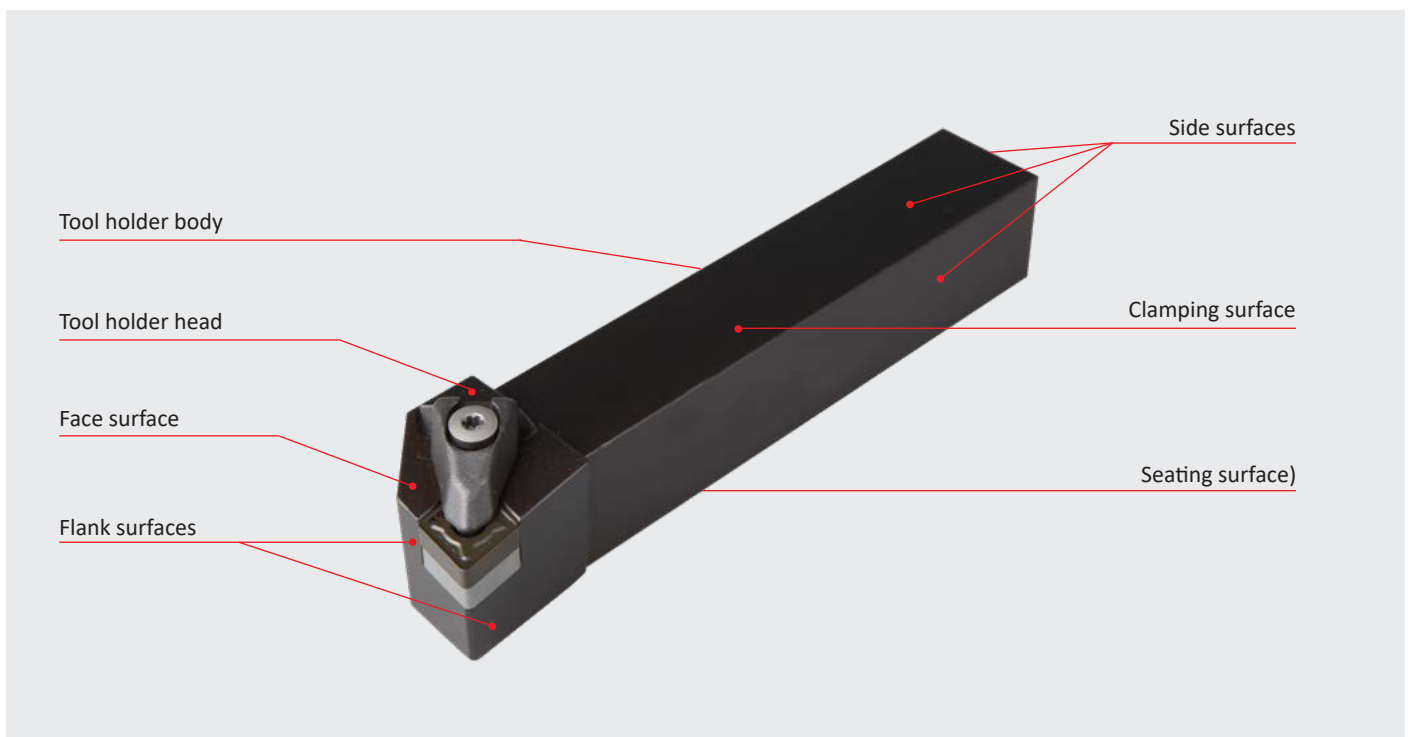

DEFINITION OF BASIC TERMS

The turning tool consists of two basic parts:

1) the body consisting of:

- seating surface
 - clamping surface
 - side surfaces (which can further be provided with adjusting screws)
- Note:** For external turning, the tool holder body is usually a square cross section (square or rectangle). For internal turning, the cross section of the holder body is circular and, for larger cross sections, it is provided with adjusting surfaces. But the holder body can also be formed by a special type of shank, such as CAPTO (PSC) or HSK

2) the head with:

- face
 - flank surfaces
- The tool holder head also includes a clamping system into which the inserts are inserted
- From the face side (for radial inserts) or from the flank surface side (for tangential inserts)
- Note: the types of heads are:**
- straight – allows turning in both directions
 - side – distinguish between right and left design
 - bent – distinguish between right and left design (allows better access when turning more complex surfaces)

Working and construction angles of turning tools

The position and orientation of the cutting edge in relation to the workpiece and its geometric shape determine the cutting angle characteristics.

The angles on the cutting edge are determined by a two coordinate system:

- a) design
- b) working

a) tool coordinate system (stationary), which is used to determine the cutting edge geometry during design, production and checking. All angles defined in this system are called tool cutting angles. All angles defined by ISO standards according to the insert shape belong in this group.

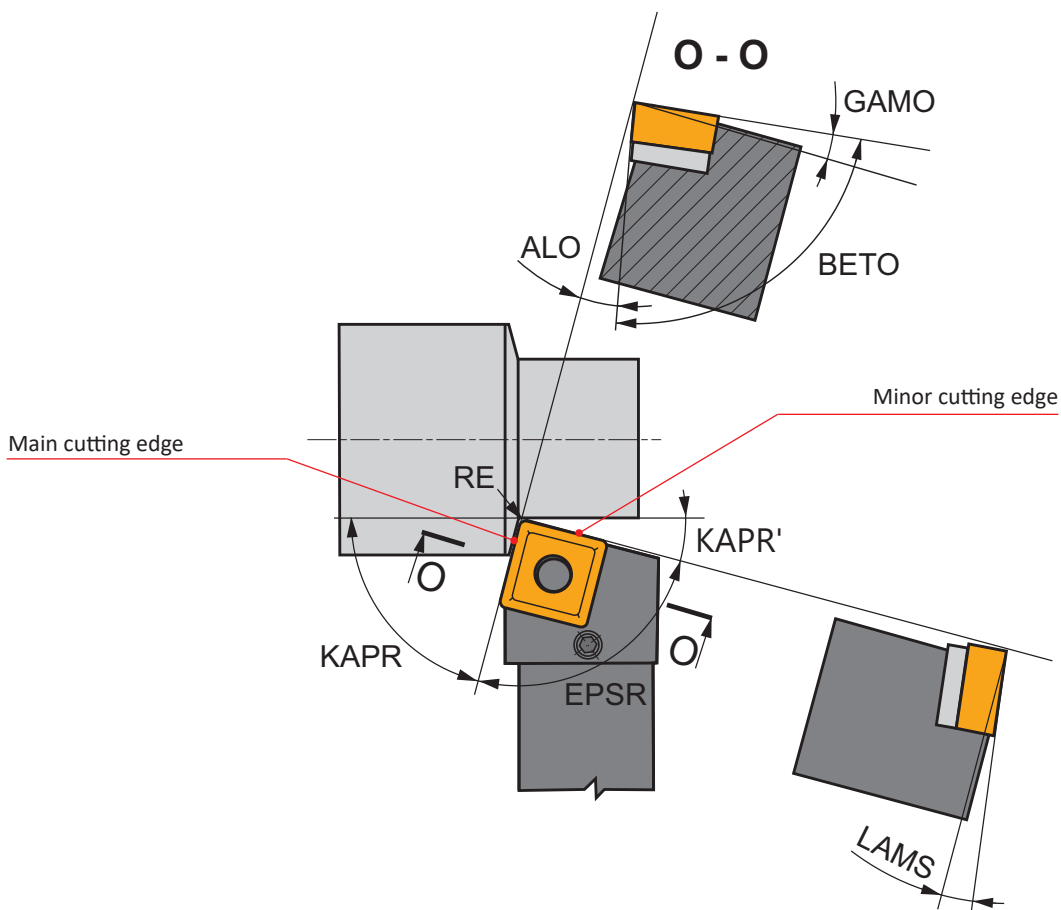

DEFINITION OF BASIC TERMS

b) working coordinate system, used to determine the cutting edge geometry during the machining process. These angles are called working angles and they depend on the position of the insert clamped into the tool holder. For example, the cutting insert SNUN has a tool clearance angle $AN = 0^\circ$ and a rake angle $GAMP = 0^\circ$, however the insert is clamped in the tool holder to give a working clearance angle $ALO = 6^\circ$ and a working rake angle $GAMO = -6^\circ$. The working angles affect the tool angles with pre-formed chip breakers. However the most important are the working angles for the cutting process.

The basic tool angles are indicated in the picture in the basic tool plane (interlaid by the bearing surface of the tool holder) and in the normal tool plane (interlaid across to cutting edge – cut O-O).

We are concerned with the following angles:

The rake angle $GAMO$ – substantially affects the cutting process. Its size determines the progress and the intensity of plastic deformation during chip forming; it also determines the value of the cutting forces and the thermal stress on the cutting edge. The range of rake angles is wide, from $GAMO = +25^\circ$ to -15° for cutting tools with indexable cutting inserts for milling and turning. A positive rake angle improves the chip forming conditions, reduces the cutting forces and reduces the cutting temperature level. A negative rake angle improves the strength of the cutting edge, however it increases plastic deformation during chip forming and thereby also the cutting forces and temperatures.

Clearance angle ALO affects the value of friction between the flank and the machined surface. Increasing the clearance angle ALO reduces this friction and thereby flank wear as well.

Wedge angle $BETO$ is the angle of the cutting insert's wedge. Increasing angle $BETO$ increases the strength of the cutting edge (resistance against shock), however it also increases the cutting resistance.

Inclination angle of main cutting edge $LAMS$ – determines the point of first contact between the cutting edge and the workpiece, which is important for interrupted cut. If $LAMS$ is positive, the point of contact is close to the nose of the cutting insert. The negative angle $LAMS$ moves the point of first contact far from the nose and thereby affects the resistance of the cutting edge against mechanical stress. Furthermore, $LAMS$ affects the direction of chip evacuation. If $LAMS$ is negative, the direction of chip evacuation is towards the machined surface. Whereas if $LAMS$ is positive, the direction of chip evacuation is away from the machined surface.

Setting angle of main cutting edge $KAPR$ has main influence on the values of cutting forces and the cross section shape of the chip. Reducing angle $KAPR$ makes the chip thinner at a given feed f and depth of cut a_p . Whereas if $KAPR = 90^\circ$ the chip thickness $h = f$ and the chip width $b = a_p$ becomes wider. Regarding the decreasing setting angle the function width of the T-land is increasing and the rake angle of insert is decreasing.

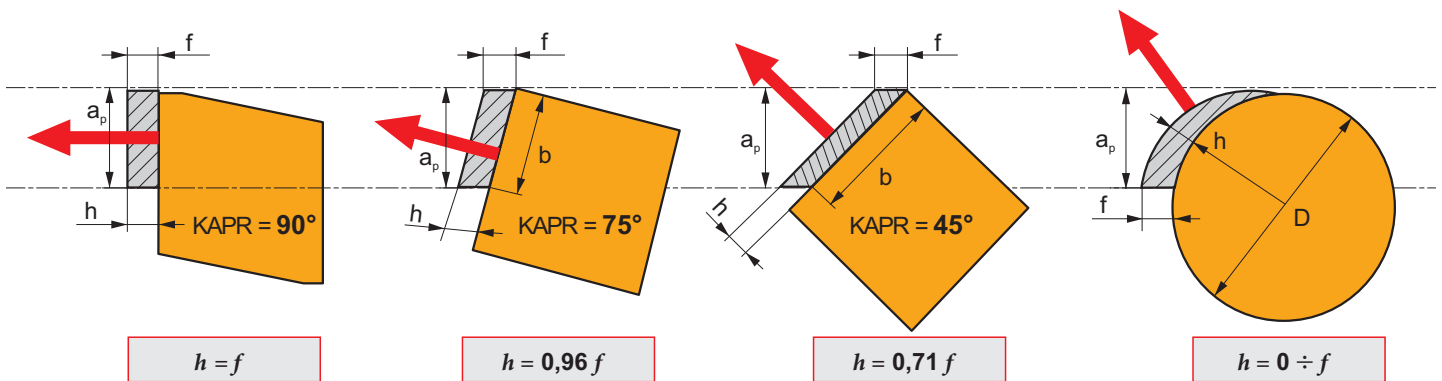

Setting angle of minor cutting edge $KAPR'$ together with corner radius RE define the final surface quality.







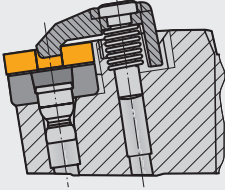
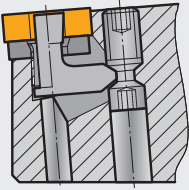
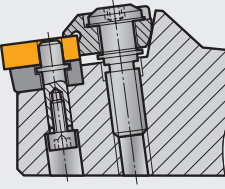
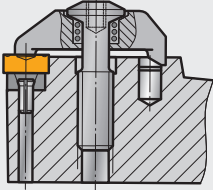
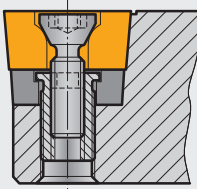
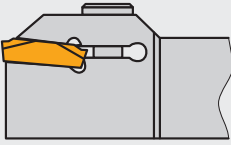

CHOICE OF CUTTING TOOL

Tool holder choice with regard to the clamping technique

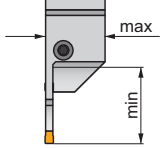
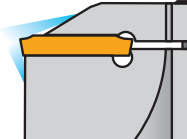
The PRAMET TOOLS offer includes tool holders, adjustable holders, turret heads and adjustable holders for external longitudinal, facing, copy turning, and naturally also for internal turning. Tool holders are classified according to the inserts clamping system into six groups that are schematically illustrated in the following passage.

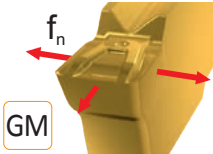
	<p>ISO D</p> <p>This is the most rigid system for clamping of negative inserts with a cylindrical hole. The insert is fixed in the pocket only by a special clamp, which fits into the hole of the insert and it pushes the insert downwards and the same time against the rear faces of the pocket. The disadvantage of this system is again the clamp, which can cause problems with chip evacuation. Holders with this system are therefore particularly suitable for external machining operations characterised by high dynamic stresses on the tool.</p>
	<p>ISO P</p> <p>This system serves for the clamping of negative inserts with cylindrical hole, both with chip formers and/or without them. The insert clamping is achieved as a result of an angle lever that after tightening the screw presses the insert down to the holder bed. Tool holders with this clamping system of inserts ensure a reliable and exact clamping of an insert. They perform the best and also the most frequent use at external turning operations, namely both finishing and roughing ones. Alternatively this type of clamping can be also used for holders intended for internal turning of holes with larger diameters.</p>
	<p>ISO M</p> <p>This system is used for the clamping of cutting inserts of the same type as that of the system ISO P. In this case an insert is set onto a strong pin to which it is pressed by a clamp that is also fixing the top of insert. This clamping system is suitable mainly for holders with supposed enhanced dynamic load. These holders are used almost exclusively for the external turning.</p>
	<p>ISO C</p> <p>This system serves for the clamping of both negative and positive inserts without holes, namely with both chip formers (pre-pressed, ground and side-pressed ones) and without them. The insert is fixed in the bed of a tool holder by a screw-held clamp, under which there is still embedded a side-pressed chip former at some insert types. Holders with this clamping system are used for both the external and internal surface machining. At present the clamping system C loses its importance. Especially at tools for internal turning it is replaced by the system S with benefit.</p>
	<p>ISO S</p> <p>This clamping system is mainly used for small cross-section tools, designed for both external and internal turning (drilling). In this case a special screw, going through an insert cone hole, achieves the clamping. By tightening this screw an insert is fixed in the tool bed. This solution is especially convenient because there is no obstacle for chip flow.</p>
	<p>ISO G</p> <p>This clamping system is used at tools for recess turning and at tools for copy turning (system CTP). The insert is pushed into the holder bed by a clamp from the top. The contact surface in the holder, in the clamp and also in the insert is shaped in such a way that it hinders the insert displacing by a feeding component of cutting speed.</p>
	<p>ISO X</p> <p>This marking identifies tools with so called special clamping system (i.e. it is different at individual tool manufacturers and suppliers). In our case we have identified under this marking tool holders that use the cutting resistance to clamp an insert into the self-locking bed. This clamping system is used for tools intended for parting and recessing.</p>

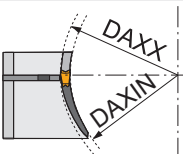
GL – GROOVING, PARTING AND COPY TURNING

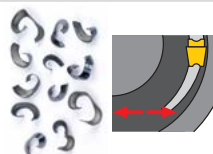
Example	Recommendation
	<p>Choose a tool holder with the maximum possible cross-section and the minimum possible tool overhang and CDX (maximum cutting depth) to reduce vibrations.</p>
	<p>Applying coolant directly to the cutting edge in sufficient quantities reduces the temperature of the cutting edge and seat, resulting in prolonged tool life.</p>
	<p>When parting off or deep grooving, it is advisable to set the cutting edge slightly higher than the workpiece axis to reduce vibrations.</p>
	<p>For parting off or deep grooving operations, use PM or PR chip breakers, which both form the desired spiral-shaped chips.</p>
	<p>When longitudinal turning, it is advisable to use tools with the minimum possible CDX (maximum cutting depth) to reduce vibrations and deflection of the tool.</p>
	<p>For longitudinal turning operations, use the GM chip breaker, which has the proper geometry on the front and both sides of the cutting edge.</p>
	<p>When copy turning with the MM chip breaker, the maximum depth of cut is 50% of the diameter of the geometry.</p>
	<p>For internal grooving operations, use only the GM and MM chip breakers, which both form the desired short chips.</p>
	<p>When face grooving, it is necessary to select a tool holder with the correct range of diameters.</p>
	<p>For deep face grooving operations, use only the GM chip breaker, which forms the desired long helical chips that don't get stuck in the face groove.</p>
	<p>For face turning and profiling operations, use only the GM and MM chip breakers, which both form the desired short chips.</p>

GROOVING, PARTING AND COPY TURNING

Recommendation for practical usage:

The procedure for turning a recess (deepening and widening) is shown in the following illustration.

Note: To create a flat seating surface, use insert type **GL** with chip breaker **GM** or LCMF with chipbreaker F. The outboard radial grooving passes should overlap the central pass by two times the insert corner radius.

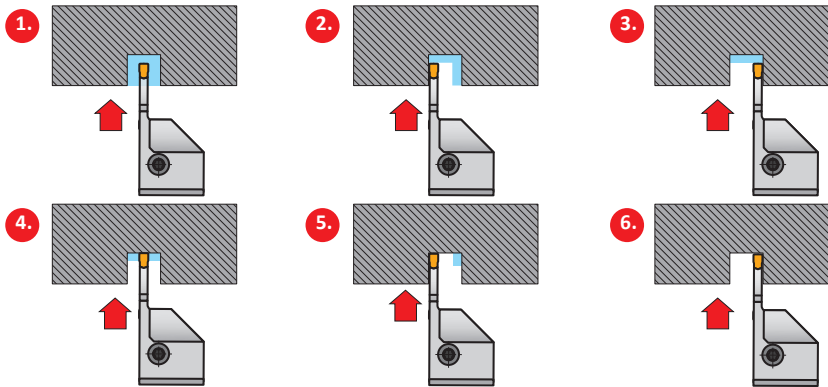

When machining a wide recess, follow the procedure shown in the following illustration.

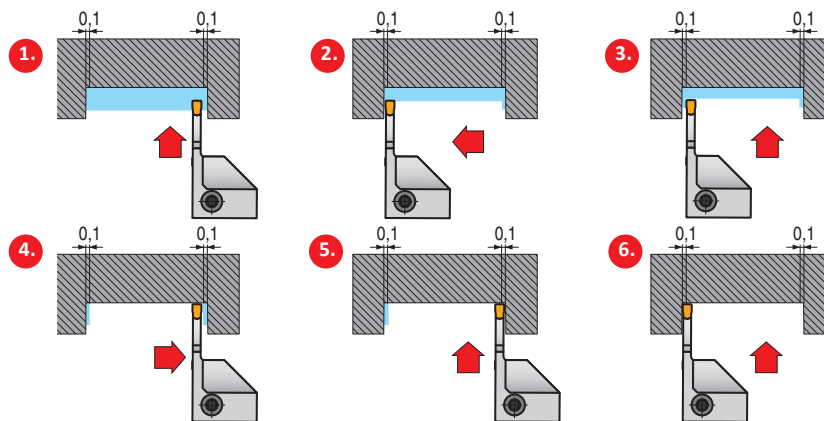

When opening up or deepening a contour using side turning, use the procedure shown in the following illustration.

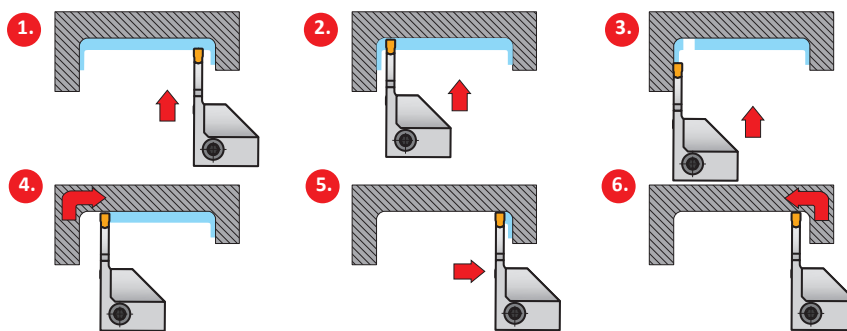

Roughing of contour (insert with round cutting edge).

Finishing of contour (insert with round cutting edge).

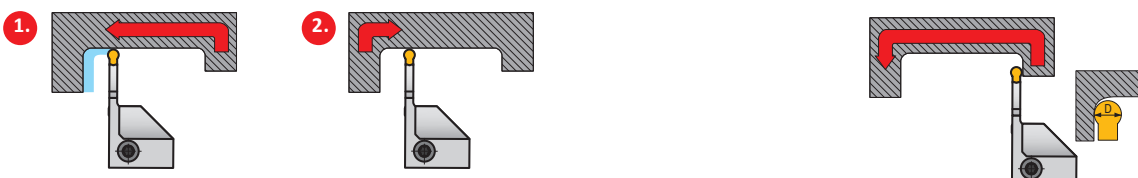

THREADING

The choice of production method is influenced by the workpiece and the machine. Workpiece – external or internal thread, right – or left-hand thread. Machine – right – or left-hand tool. For guidance, you can use table below.

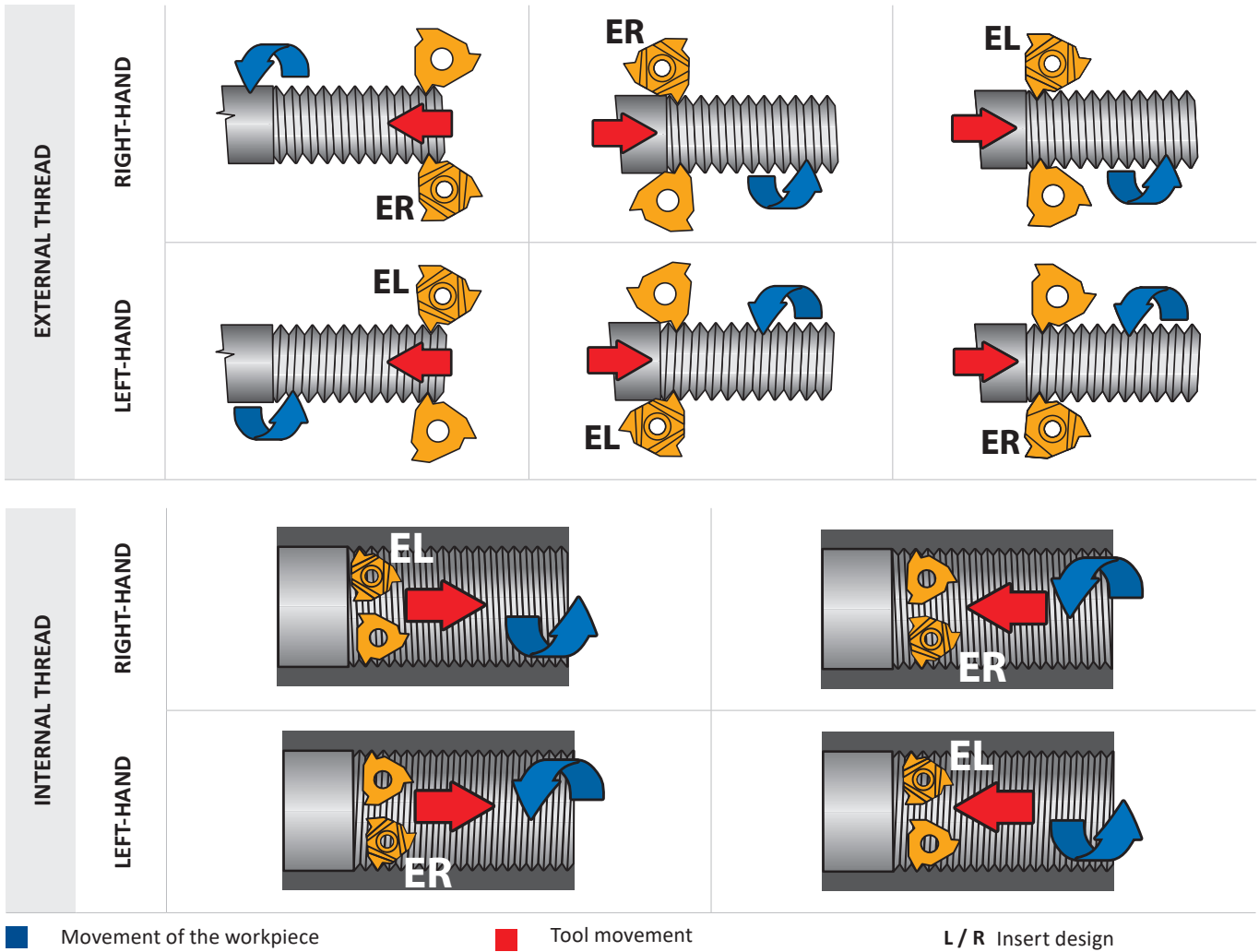

The following formula can be used to calculate the helix angle:

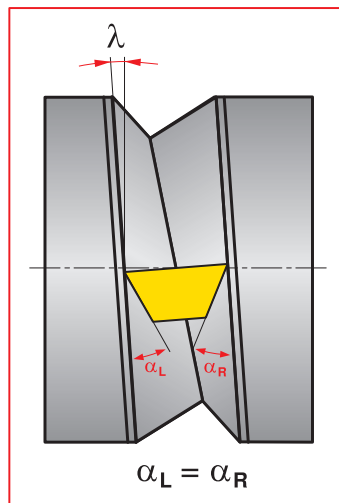
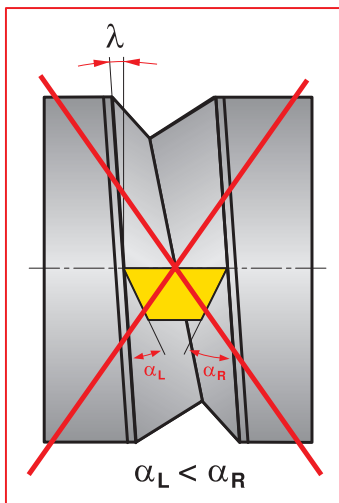

$$\operatorname{tg} \omega = \frac{p}{d_s \cdot \pi}$$

ω helix angle [°]

p pitch [mm]

d_s pitch diameter [mm]

To generate the correct shape on the thread and uniform wear on the insert, the cutting edge helix angle should be equal to the thread lead angle.

Tool holders are usually supplied with a helix angle $\lambda = 1.5^\circ$. A different helix angle can be selected by changing the anvil.

Use the following graph or table to choose the correct anvil.

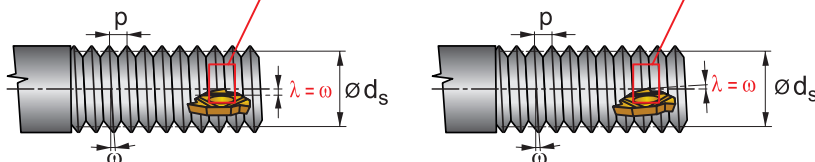

THREADING

Choice of shim

Helix angle λ	Positive					Negative	
	4.5°	3.5°	2.5°	1.5°	0.5°	-0.5°	-1.5°
Tool holder	Anvil specification						
SER16; SIL16	PE16+4.5	PE16+3.5	PE16+2.5	PE16+1.5	PE16+0.5	PE16-0.5	PE16-1.5
SEL16; SIR16	PI16+4.5	PI16+3.5	PI16+2.5	PI16+1.5	PI16+0.5	PI16-0.5	PI16-1.5
SER22; SIL22	PE22+4.5	PE22+3.5	PE22+2.5	PE22+1.5	PE22+0.5	PE22-0.5	PE22-1.5
SEL22; SIR22	PI22+4.5	PI22+3.5	PI22+2.5	PI22+1.5	PI22+0.5	PI22-0.5	PI22-1.5
SER-S22; SIL-S22	PE22S+4.5	PE22S+3.5	PE22S+2.5	PE22S+1.5	PE22S+0.5	PE22S-0.5	PE22S-1.5
SEL-S22; SIR-S22	PI22S+4.5	PI22S+3.5	PI22S+2.5	PI22S+1.5	PI22S+0.5	PI22S-0.5	PI22S-1.5

Tool holders are usually supplied with a helix angle $\lambda = 1.5^\circ$. A different helix angle can be selected by changing the anvil.
Shims for holders SER-S22, SIR-S22 are marked with „S“

Graph for shim selection

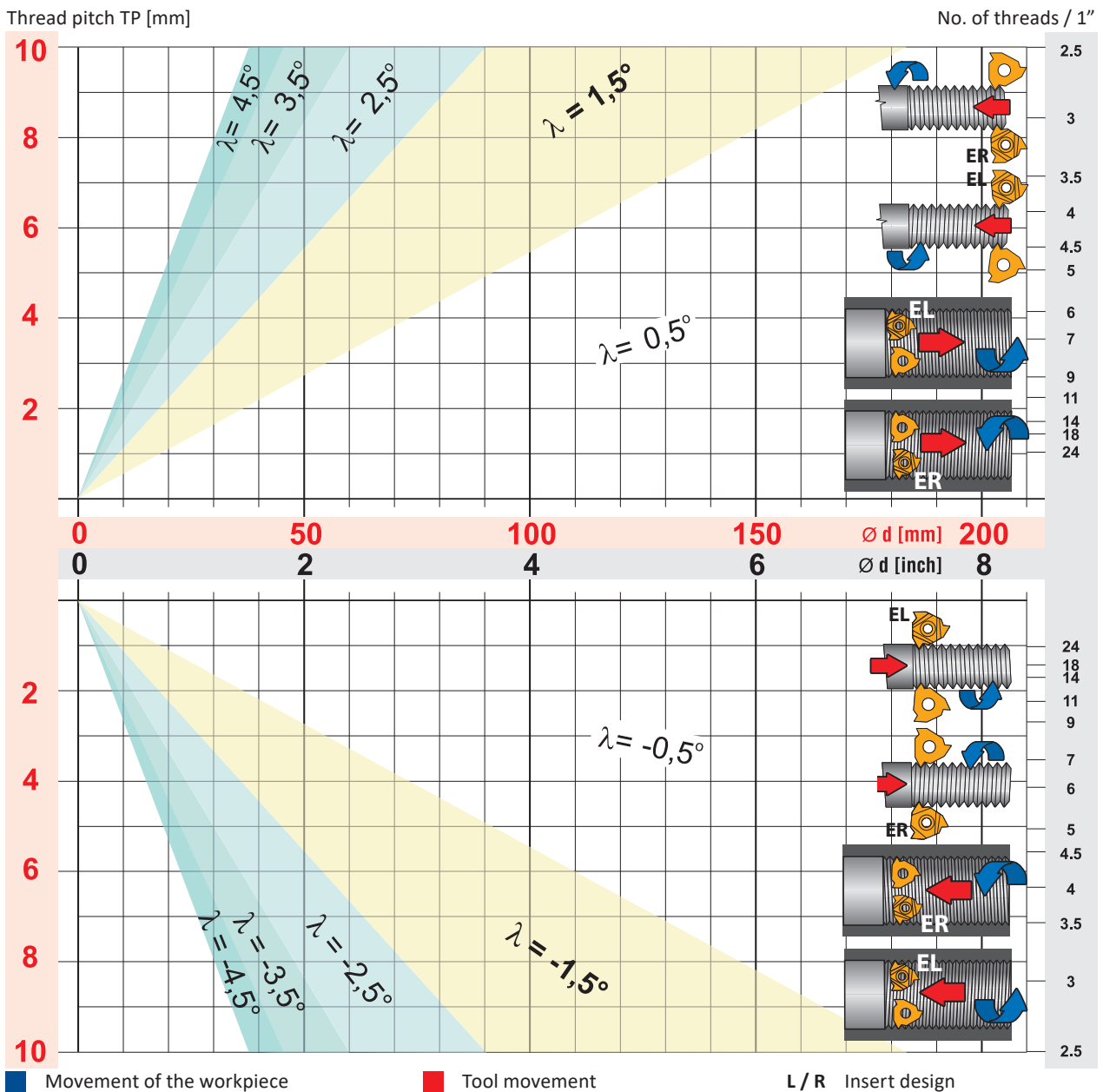

CORRECTION FACTORS

Cutting speed correction factor C_{VcO} as a function of the feed rate change:

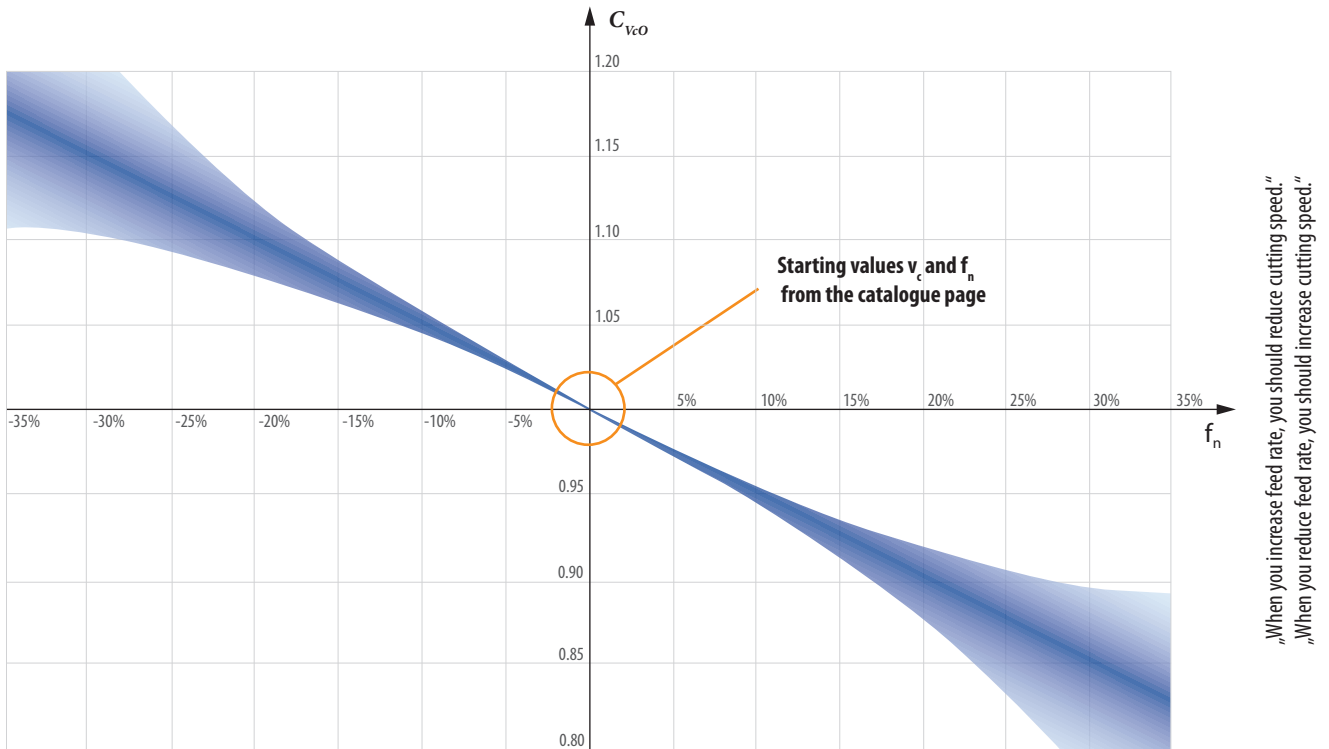

Correction factors for required durability C_{VcT}

 minutes	10	15	20	30	45	60
General machining operations (fine finishing up to roughing)	1.13	1.00	0.93	0.84	0.76	0.71
Heavy machining operations (heavy roughing)	–	–	–	1.10	1.00	0.93

Additional correction factors C_{VcA}

Machining environment	C_{VcA}	C_{VcB}
Condition of the work-material (hard skin due to forging or casting)	0.70	
Internal turning	0.75	
Parting and grooving (radial)	0.88	
Face grooving	0.80	
Interrupted cut		0.80
Unstable machining conditions		0.85
Common machining conditions		1.00
Stable machining conditions		1.20

Resulting corrected cutting speed v_{cC}

$$v_{cC} = v_c \cdot k_{vG} \cdot C_{VcO} \cdot C_{VcT} \cdot C_{VcA} \cdot C_{VcB}$$

k_{vG} – coefficient of used material
 v_c – starting speed from catalogue page

FORMULA FOR CALCULATING CUTTING DATA

Value	Formula	Unit	Note															
Number of revolutions	$n = \frac{v_c \cdot 1000}{D \cdot \pi}$	(1/min)	<table style="width: 100%; border: none;"> <tr> <td style="width: 10%;">n</td> <td>Number of revolutions</td> <td>(1/min)</td> </tr> <tr> <td>D</td> <td>Diameter (of tool or workpiece)</td> <td>(mm)</td> </tr> </table>	n	Number of revolutions	(1/min)	D	Diameter (of tool or workpiece)	(mm)									
n	Number of revolutions	(1/min)																
D	Diameter (of tool or workpiece)	(mm)																
Cutting speed	$v_c = \frac{\pi \cdot D \cdot n}{1000}$	(m/min)	<table style="width: 100%; border: none;"> <tr> <td>v_c</td> <td>Cutting speed</td> <td>(m/min)</td> </tr> <tr> <td>f_{rev}</td> <td>Feed per revolution</td> <td>(mm/rev)</td> </tr> <tr> <td>f_{min}</td> <td>Feed per minute (Linear Feedrate)</td> <td>(mm/min)</td> </tr> </table>	v_c	Cutting speed	(m/min)	f_{rev}	Feed per revolution	(mm/rev)	f_{min}	Feed per minute (Linear Feedrate)	(mm/min)						
v_c	Cutting speed	(m/min)																
f_{rev}	Feed per revolution	(mm/rev)																
f_{min}	Feed per minute (Linear Feedrate)	(mm/min)																
Feed per revolution	$f_{rev} = \frac{f_{min}}{n}$	(mm/rev)																
Feed per minute (Linear Feedrate)	$f_{min} = v_f = f_{rev} \cdot n$	(mm/min)																
Max. height of profile R_{max}	$R_{max} = \frac{125 \cdot f_{rev}^2}{RE}$	(μ m)	<table style="width: 100%; border: none;"> <tr> <td>R_{max}</td> <td>max. height of profile</td> <td>(mm)</td> </tr> <tr> <td>R_a</td> <td>surface finish</td> <td>(mm)</td> </tr> <tr> <td>f_{rev}</td> <td>feed per revolution</td> <td>(mm/rev)</td> </tr> <tr> <td>RE</td> <td>nose radius</td> <td>(mm)</td> </tr> </table>	R_{max}	max. height of profile	(mm)	R_a	surface finish	(mm)	f_{rev}	feed per revolution	(mm/rev)	RE	nose radius	(mm)			
R_{max}	max. height of profile	(mm)																
R_a	surface finish	(mm)																
f_{rev}	feed per revolution	(mm/rev)																
RE	nose radius	(mm)																
Surface finish R_a	$R_a = \frac{43,9 \cdot f_{rev}^{1,88}}{RE^{0,97}}$	(μ m)																
Chip cross section	$A = f_{rev} \cdot a_p$	(mm ²)	<table style="width: 100%; border: none;"> <tr> <td>A</td> <td>Chip cross section</td> <td>(mm²)</td> </tr> <tr> <td>f_{rev}</td> <td>Feed per revolution</td> <td>(mm/rev)</td> </tr> <tr> <td>a_p</td> <td>Axial depth of cut</td> <td>(mm)</td> </tr> </table>	A	Chip cross section	(mm ²)	f_{rev}	Feed per revolution	(mm/rev)	a_p	Axial depth of cut	(mm)						
A	Chip cross section	(mm ²)																
f_{rev}	Feed per revolution	(mm/rev)																
a_p	Axial depth of cut	(mm)																
Chip thickness (For insert with straight edge)	$h = f_{rev} \cdot \sin \kappa_r$	(mm)	<table style="width: 100%; border: none;"> <tr> <td>κ_r</td> <td>Primary edge setting angle</td> <td>($^\circ$)</td> </tr> <tr> <td>h</td> <td>Chip thickness</td> <td>(mm)</td> </tr> </table>	κ_r	Primary edge setting angle	($^\circ$)	h	Chip thickness	(mm)									
κ_r	Primary edge setting angle	($^\circ$)																
h	Chip thickness	(mm)																
Chip thickness (For round cutting insert)	$h = f_{rev} \cdot \sqrt{\frac{a_p}{INSD}}$	(mm)	<table style="width: 100%; border: none;"> <tr> <td>v_c</td> <td>Cutting speed</td> <td>(m/min)</td> </tr> <tr> <td>f_{min}</td> <td>Feed per minute (Linear Feedrate)</td> <td>(mm/min)</td> </tr> <tr> <td>Q</td> <td>Material removal rate per minute</td> <td>(cm³/min)</td> </tr> <tr> <td>$INSD$</td> <td>Insert diameter</td> <td>(mm)</td> </tr> </table>	v_c	Cutting speed	(m/min)	f_{min}	Feed per minute (Linear Feedrate)	(mm/min)	Q	Material removal rate per minute	(cm ³ /min)	$INSD$	Insert diameter	(mm)			
v_c	Cutting speed	(m/min)																
f_{min}	Feed per minute (Linear Feedrate)	(mm/min)																
Q	Material removal rate per minute	(cm ³ /min)																
$INSD$	Insert diameter	(mm)																
Metal removal rate	$Q = a_p \cdot f_{rev} \cdot v_c$	(cm ³ /min)																
Power demand	$P_c = \frac{a_p \cdot f_{rev}^{1-c} \cdot k_{cl} \cdot v_c \cdot k \kappa_r}{6 \cdot 10^4 \cdot \eta}$	(kW)	<table style="width: 100%; border: none;"> <tr> <td>P_c</td> <td>Power demand</td> <td>(kW)</td> </tr> <tr> <td>a_p</td> <td>Depth of cut</td> <td>(mm)</td> </tr> <tr> <td>f_{rev}</td> <td>Feed</td> <td>(mm/rev)</td> </tr> </table>	P_c	Power demand	(kW)	a_p	Depth of cut	(mm)	f_{rev}	Feed	(mm/rev)						
P_c	Power demand	(kW)																
a_p	Depth of cut	(mm)																
f_{rev}	Feed	(mm/rev)																
Approximate power demand	$P_c = \frac{a_p \cdot f_{rev} \cdot v_c}{x}$	(kW)	<table style="width: 100%; border: none;"> <tr> <td>c</td> <td>Constant KTV</td> <td>(1)</td> </tr> <tr> <td>k_c</td> <td>Specific cutting force</td> <td>(MPa)</td> </tr> <tr> <td>k_{κ_r}</td> <td>κ_r angle constant</td> <td>(1)</td> </tr> <tr> <td>η</td> <td>Efficiency (usually $\eta = 0,75$)</td> <td>(1)</td> </tr> <tr> <td>x</td> <td>Machined material constant</td> <td>(1)</td> </tr> </table>	c	Constant KTV	(1)	k_c	Specific cutting force	(MPa)	k_{κ_r}	κ_r angle constant	(1)	η	Efficiency (usually $\eta = 0,75$)	(1)	x	Machined material constant	(1)
c	Constant KTV	(1)																
k_c	Specific cutting force	(MPa)																
k_{κ_r}	κ_r angle constant	(1)																
η	Efficiency (usually $\eta = 0,75$)	(1)																
x	Machined material constant	(1)																

Material	Steel	Cast iron	Al
Coefficient x	20	25	100

RECOMMENDED SCREW TORQUES

CLAMPING SCREW

Screw designation	Screwdriver	Torque (Nm)
28588	MA2-8304	0.8
28992	MA2-8304	0.8
416.1-832	PT-8002	3.6
5513 020-01	PT-8004	3.6
5513 020-03	PT-8001	0.8
5513 020-04	PT-8003	1.5
5513 020-05	PT-8001	0.8
5513 020-14	TX 225PLUS	8.5
5513 020-24	PT-8002	1.5
5513 020-27	PT-8000	0.6
5513 020-28	PT-8000	0.6
5513 021-03	DMN 3124	13
CS 8601-T09P	SDR T09P	1.7
CS 8601-T15P	SDR T15P	3.9
CS 8601-T20P	SDR T20P	6.4
CS 8601-T25P	SDR T25P	9.5
DVF 0573	PT-8002	1.5
DVF 2260	TX 215PLUS	3.6
DVF 3584	DMD 1650	0.6
DVF 3593	TX 207PLUS	0.8
HS 0408	HXK 3	5
HS 0412	HXK 3	5
HS 0516	HXK 4	5
HS 0520C	HXK 4	5
HS 0616C	HXK 5	8
HS 0620	HXK 5	6
HS 0620C	HXK 5	6
HS 0625	HXK 5	6
HS 0625C	HXK 5	6
HS 0630	HXK 5	6
HS 0825	HXK 6	10
HS 0830	HXK 6	10
HS 0835	HXK 6	10
HS 0840	HXK 8	11
HS 1030	HXK 8	8
HS 1060	HXK 6	10
HS 93	HXK 5	8
HS 94	HXK 5	8
HSI 1020	HXK 6	8
PS 0512	HXK 2	2
PS 0512-A	HXK 2	2
PS 0616	HXK 2,5	4
PS 12040	HXK 5	8

TORQUE SCREWDRIVERS

Torque handle	Torque (Nm)	Clamping screw thread
MR-0.8-2.0 vario	0.5 – 2.0	M 2 – M 3
MR-1.0-5.0 vario	0.8 – 5.0	M 2.5 – M 5
MR-0.9 fix	0.9	M 2
MR-2.0 fix	2.0	M 3
MR-3.0 fix	3.0	M 3.5
MR-3.5 fix	3.5	M 4
MR-5.0 fix	5.0	M 5

CLAMPING SCREW

Screw designation	Screwdriver	Torque (Nm)
PS 6026-709P	SRD T09P	2
PS 8290	HXK 2	2
SR 14	HXK 10	10
SR 85011-T15P	SDR T15P	5
SR 85017-T09P	SDR T09P	2
SR 85020-T15P	SDR T15P	3
SR 86025-T20P	SRD T20P	5
SR 88026-T30P	LKT30P	5
T20.037	DMD 1650	0.6
UP 0909-T09P	SRD T09P	2
UP 1515-T15P	SDR T15P	8
US 2505-T07P	SDR T07P	0.9
US 2506-T07P	SDR T07P	0.9
US 3007-T09P	SDR T09P	2
US 34	HXK 3	5
US 35	HXK 4	6
US 3508-T15P	SDR T15P	3
US 3510A-T15P	SDR T15P	3
US 3510-T15P	SDR T15P	3
US 3512A-T15P	SDR T15P	3
US 3512-T15P	SDR T15P	3
US 36	HXK 4	6
US 38	HXK 5	8
US 39	HXK 5	8
US 40	HXK 4	6
US 4008-T15P	SDR T15P	3.5
US 4011-T15P	SDR T15P	3.5
US 41	HXK 4	6
US 42	HXK 4	6
US 45013-T20P	SDR T20P	5
US 4512-T15P	SDR T15P	5
US 4514A-T20	SDR T20	5
US 46	HXK 3	5
US 46017-T20P	SDR T20P	5
US 47	HXK 5	8
US 5012-T15P	SDR T15P	5
US 5015-T20P	SDR T20P	5
US 5018-T20P	SDR T20P	5
US 6020-T25P	SDR T25P	6
US 64518-T15P	SDR T15P	5
US 8025-T30P	SDR T20P	13
US 83	HXK 4	6
US 95	HXK 4	10

REPLACEABLE SHANKS

Replaceable shanks		
D-T6	D-T8	D-T15
D-T6P	D-T8P	D-T15P
D-T7	D-T9	D-T20
D-T7P	D-T9P	D-T20P

SCREW LUBRICATION

Insert clamping screws are subject to high thermal stresses. It is recommended that all screws be lubricated with a high quality paste such as MOLYKOTE 1000.

COMPLETE CLAMP SET

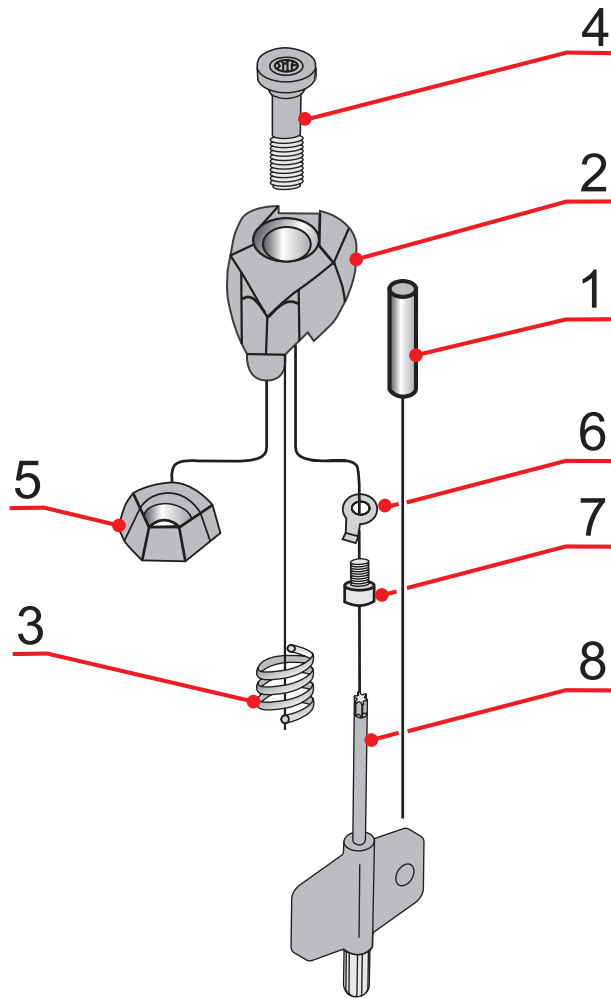

	1	2	3	4		5	6	7	8
DCS 09	CP 2655	CD 09	PR 0157	CS 8601-T09P	1.7	-	-	-	-
DCS 12	CP 2607	CD 12	PR 0158	CS 8602-T15P	3.9	-	-	-	-
DCS 16	CP 2607	CD 16	PR 0159	CS 8603-T20P	6.4	-	-	-	-
DCS 19	CP 2607	CD 19	PR 0159	CS 8603-T20P	6.4	-	-	-	-
DCS 25	CP 2607	CD 25	PR 0101	CS 8604-T25P	9.5	-	-	-	-
DCS 16V	CP 2607	CD 16V	PR 0158	CS 8602-T15P	3.9	-	-	-	-
DCS 12C2	CP 2607	CD 12C2	PR 0158	CS 8602-T15P	3.9	PP 3002	H 1201	CS 9701-T07P	FLAG T07P
DCS 16C2	CP 2607	CD 16C2	PR 0159	CS 8603-T20P	6.4	PP 3003	H 1201	CS 9701-T07P	FLAG T07P
DCS 12C4	CP 2607	CD 12C4	PR 0158	CS 8602-T15P	3.9	PP 3002	H 1201	CS 9701-T07P	FLAG T07P
DCS 16C4	CP 2607	CD 16C4	PR 0159	CS 8603-T20P	6.4	PP 3003	H 1201	CS 9701-T07P	FLAG T07P

WMG (WORK MATERIAL GROUP)

ISO group	WMG (Work Material Group)	Hardness (HB or HRC)	Ultimate Tensile Strength (MPa)	
P	P1 P1.1 Free machining steel P1.2 (carbon steels with increased machinability) P1.3	Sulfurized	< 240 HB	≤ 830
		Sulfurized and phosphorized	< 180 HB	≤ 620
		Sulfurized/phosphorized and leaded	< 180 HB	≤ 620
	P2 P2.1 Plain carbon steel P2.2 (steels comprised of mainly iron and carbon) P2.3	Containing <0.25 % C	< 180 HB	≤ 620
		Containing <0.55 % C	< 240 HB	≤ 830
		Containing >0.55 % C	< 300 HB	≤ 1030
	P3 P3.1 Alloy steel P3.2 (carbon steels with an alloying content ≤ 10%) P3.3	Annealed	< 180 HB	≤ 620
		Hardened and tempered	180 – 260 HB	> 620 ≤ 900
			260 – 360 HB	> 900 ≤ 1240
	P4 P4.1 Tool steel P4.2 (special alloy steel for tools, dies and molds) P4.3	Annealed	< 26 HRC	≤ 900
Hardened and tempered		26 – 39 HRC	> 900 ≤ 1240	
		39 – 45 HRC	> 1240 ≤ 1450	
M	M1 M1.1 Ferritic stainless steel M1.2 (straight chromium non-hardenable alloys)	Annealed	< 160 HB	≤ 520
		160 – 220 HB	> 520 ≤ 700	
	M2 M2.1 Martensitic stainless steel M2.2 (straight chromium hardenable alloys) M2.3	Quenched and tempered	200 – 280 HB	> 670 ≤ 950
		Precipitation-hardened	280 – 380 HB	> 950 ≤ 1300
			< 200 HB	≤ 750
	M3 M3.1 Austenitic stainless steel M3.2 (chromium-nickel and chromium-nickel-manganese alloys) M3.3	200 – 260 HB	> 750 ≤ 870	
		260 – 300 HB	> 870 ≤ 1040	
		< 300 HB	≤ 990	
	M4 M4.1 Austenitic-ferritic (DUPLIX) or super-austenitic stainless steel M4.2 Precipitation hardening austenitic stainless steel	300 – 380 HB	≤ 1320	
K	K1 K1.1 Gray iron or Automotive Gray iron (GG) K1.2 (iron-carbon castings with a lamellar graphite microstructure) K1.3	Ferritic or ferritic-pearlitic	< 180 HB	≤ 190
		Ferritic-pearlitic or pearlitic	180 – 240 HB	> 190 ≤ 310
		Pearlitic	240 – 280 HB	> 310 ≤ 390
	K2 K2.1 Malleable iron (GTS/GTW) K2.2 (iron-carbon castings with a graphite-free microstructure) K2.3	Ferritic	< 160 HB	≤ 400
		Ferritic or pearlitic	160 – 200 HB	> 400 ≤ 550
		Pearlitic	200 – 240 HB	> 550 ≤ 660
	K3 K3.1 Ductile iron (GGG) K3.2 (iron-carbon castings with a nodular graphite microstructure) K3.3	Ferritic	< 180 HB	≤ 560
		Ferritic or pearlitic	180 – 220 HB	> 560 ≤ 680
		Pearlitic	220 – 260 HB	> 680 ≤ 800
	K4 K4.1 Austenitic gray iron (ASTM A436) K4.2 (iron-carbon alloy castings with an austenitic lamellar graphite microstructure) K4.3 Austenitic ductile iron (ASTM A439 or ASTM A571) K4.4 (iron-carbon alloy castings with an austenitic nodular graphite microstructure) K4.5	< 180 HB	≤ 190	
< 240 HB		≤ 740		
< 280 HB		> 840 ≤ 980		
280 – 320 HB		> 980 ≤ 1130		
320 – 360 HB		> 1130 ≤ 1280		
K5 K5.1 Compacted graphite iron CGI (ASTM A842) K5.2 (iron-carbon castings with a vermicular graphite structure) K5.3	Ferritic	< 180 HB	≤ 400	
	Ferritic-pearlitic	180 – 220 HB	> 400 ≤ 450	
	Pearlitic	220 – 260 HB	> 450 ≤ 500	
N	N1 N1.1 Commercially pure wrought aluminium N1.2 Wrought aluminium alloys N1.3	Half hard tempered	60 – 100 HB	> 240 ≤ 400
		Full hard tempered	100 – 150 HB	> 400 ≤ 590
		< 75 HB	≤ 240	
	N2 N2.1 Cast aluminium alloys N2.2 N2.3	75 – 90 HB	> 240 ≤ 270	
		90 – 140 HB	> 270 ≤ 440	
		–	–	
	N3 N3.1 Free-cutting copper-alloys materials with excellent machining properties N3.2 Short-chip copper-alloys with good to moderate machining properties N3.3 Electrolytic copper and long-chip copper-alloys with moderate to poor machining properties	–	–	
		–	–	
		–	–	
	N4 N4.1 Thermoplastic polymers N4.2 Thermosetting polymers N4.3 Reinforced polymers or composites	–	–	
–		–		
N5 N5.1 Graphite	–	–		
S	S1 S1.1 Titanium or titanium alloys S1.2 S1.3	< 200 HB	≤ 660	
		200 – 280 HB	> 660 ≤ 950	
		280 – 360 HB	> 950 ≤ 1200	
	S2 S2.1 Fe-based high-temperature alloys S2.2	< 200 HB	≤ 690	
		200 – 280 HB	> 690 ≤ 970	
	S3 S3.1 Ni-based high-temperature alloys S3.2	< 280 HB	≤ 940	
		280 – 360 HB	> 940 ≤ 1200	
	S4 S4.1 Co-based high-temperature alloys S4.2	< 240 HB	≤ 800	
240 – 320 HB		> 800 ≤ 1070		
H	H1 H1.1 Chilled cast iron	< 440 HB	–	
		< 55 HRC	–	
	H2 H2.1 Hardened cast iron H2.2	> 55 HRC	–	
		< 51 HRC	–	
	H3 H3.1 Hardened steel < 55 HRC H3.2	51 – 55 HRC	–	
		55 – 59 HRC	–	
	H4 H4.1 Hardened steel > 55 HRC H4.2	> 59 HRC	–	

HARDNESS CONVERSION TABLE

Strength (MPa)	Hardness			
	BRINELL	VICKERS	ROCKWELL	ROCKWELL
R_m	HB	HV	HRB	HRC
285	86	90	1190	–
320	95	100	56.2	–
350	105	110	62.3	–
385	114	120	66.7	–
415	124	130	71.2	–
450	133	140	75.0	–
480	143	150	78.7	–
510	152	160	81.7	–
545	162	170	85.8	–
575	171	180	87.1	–
610	181	190	89.5	–
640	190	200	91.5	–
675	199	210	93.5	–
705	209	220	95	–
740	219	230	96.7	–
770	228	240	98.1	–
800	238	250	99.5	–
820	242	255	–	23.1
850	252	265	–	24.8
880	261	275	–	26.4
900	266	280	–	27.1
930	276	290	–	28.5
950	280	295	–	29.2
995	295	310	–	31.0
1030	304	320	–	32.2
1060	314	330	–	33.3
1095	323	340	–	34.4
1125	333	350	–	35.5
1155	342	360	–	36.6

Strength (MPa)	Hardness			
	BRINELL	VICKERS	ROCKWELL	ROCKWELL
R_m	HB	HV	HRB	HRC
1190	352	370	–	37.7
1220	361	380	–	38.8
1255	371	390	–	39.8
1290	380	400	–	40.8
1320	390	410	–	41.8
1350	399	420	–	42.7
1385	409	430	–	43.6
1420	418	440	–	44.5
1455	428	450	–	45.3
1485	437	460	–	46.1
1520	447	470	–	46.9
1555	456	480	–	47.7
1595	466	490	–	48.4
1630	475	500	–	49.1
1665	485	510	–	49.8
1700	494	520	–	50.5
1740	504	530	–	51.1
1775	513	540	–	51.7
1810	523	550	–	52.3
1845	532	560	–	53.0
1880	542	570	–	53.6
1920	551	580	–	54.1
1955	561	590	–	54.7
1995	570	600	–	55.2
2030	580	610	–	55.7
2070	589	620	–	56.3
2105	599	630	–	56.8
2145	608	640	–	57.3
2180	618	650	–	57.8

SIMPLY RELIABLE

As a professional you can judge the quality of work by just looking at the chip. Our chip is a clean and uncomplicated shape that in itself tells a story. It is a clear and consistent signal and that's why we use it as a symbol for being **Simply Reliable**.



DORMER PRAMET

www.dormerpramet.com



**CONTACTS TO LOCAL
SALES SUPPORT
ALWAYS UP TO DATE!**

DP-CAT-TURNING-2024-EN

FOLLOW US...



ONLINE



SEGMENTS



LIBRARY APP.



CALCULATOR APP.